

## 60V 2MHz Synchronous 4-Switch Buck-Boost Controller with Spread Spectrum

### FEATURES

- 4-Switch Single Inductor Architecture Allows  $V_{IN}$  Above, Below or Equal to  $V_{OUT}$
- Up to 95% Efficiency at 2MHz
- Proprietary Peak-Buck Peak-Boost Current Mode
- Wide  $V_{IN}$  Range: 4V to 60V
- $\pm 1.5\%$  Output Voltage Accuracy:  $1V \leq V_{OUT} \leq 60V$
- $\pm 3\%$  Input or Output Current Accuracy with Monitor
- Spread Spectrum Frequency Modulation for Low EMI
- High Side PMOS Load Switch Driver
- No Top MOSFET Refresh Noise in Buck or Boost
- Adjustable and Synchronizable: 600kHz to 2MHz
- $V_{OUT}$  Disconnected from  $V_{IN}$  During Shutdown
- Available in 28-Lead TSSOP with Exposed Pad and 28-Lead QFN (4mm x 5mm)

### APPLICATIONS

- Automotive, Industrial, Telecom Systems
- High Frequency Battery-Powered System

### DESCRIPTION

The **LT<sup>®</sup>8390A** is a synchronous 4-switch buck-boost DC/DC controller that regulates output voltage, input or output current from an input voltage above, below, or equal to the output voltage. The proprietary peak-buck peak-boost current mode control scheme allows adjustable and synchronizable 600kHz to 2MHz fixed frequency operation, or internal 25% triangle spread spectrum frequency modulation for low EMI. With a 4V to 60V input voltage range, 0V to 60V output voltage capability, and seamless low noise transitions between operation regions, the LT8390A is ideal for voltage regulator, battery and supercapacitor charger applications in automotive, industrial, telecom, and even battery-powered systems.

The LT8390A provides input or output current monitor and power good flag. Fault protection is also provided to detect output short-circuit condition, during which the LT8390A retries, latches off, or keeps running.

LT, LT, LTC, LTM, Linear Technology and the Linear logo are registered trademarks of Analog Devices, Inc. All other trademarks are the property of their respective owners.

### TYPICAL APPLICATION

95% Efficient 48W (12V 4A) 2MHz Buck-Boost Voltage Regulator

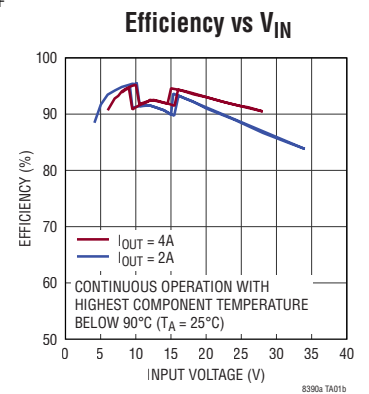
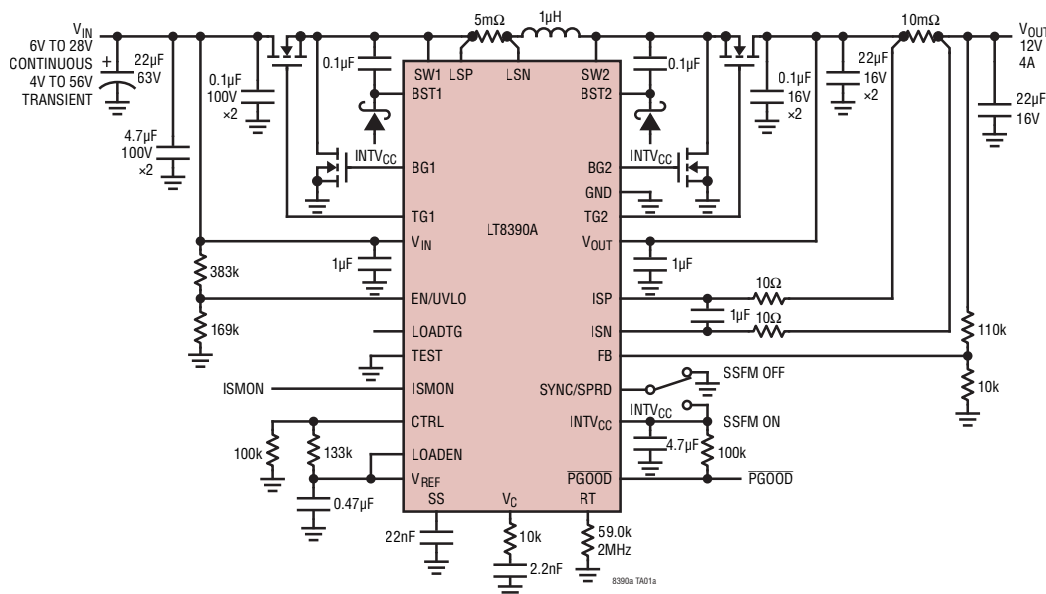

# LT8390A

## ABSOLUTE MAXIMUM RATINGS (Note 1)

$V_{IN}$ , EN/UVLO, $V_{OUT}$ , ISP, ISN .....	60V	FB, LOADEN, SYNC/SPRD, CTRL, PGOOD .....	6V
(ISP-ISN) .....	-1V to 1V	Operating Junction Temperature Range (Notes 2, 3)	
BST1, BST2 .....	66V	LT8390AE .....	-40°C to 125°C
SW1, SW2, LSP, LSN .....	-6V to 60V	LT8390AI .....	-40°C to 125°C
INTV <sub>CC</sub> , (BST1-SW1), (BST2-SW2) .....	6V	LT8390AH .....	-40°C to 150°C
(BST1-LSP), (BST1-LSN) .....	6V	Storage Temperature Range .....	-65°C to 150°C

## PIN CONFIGURATION

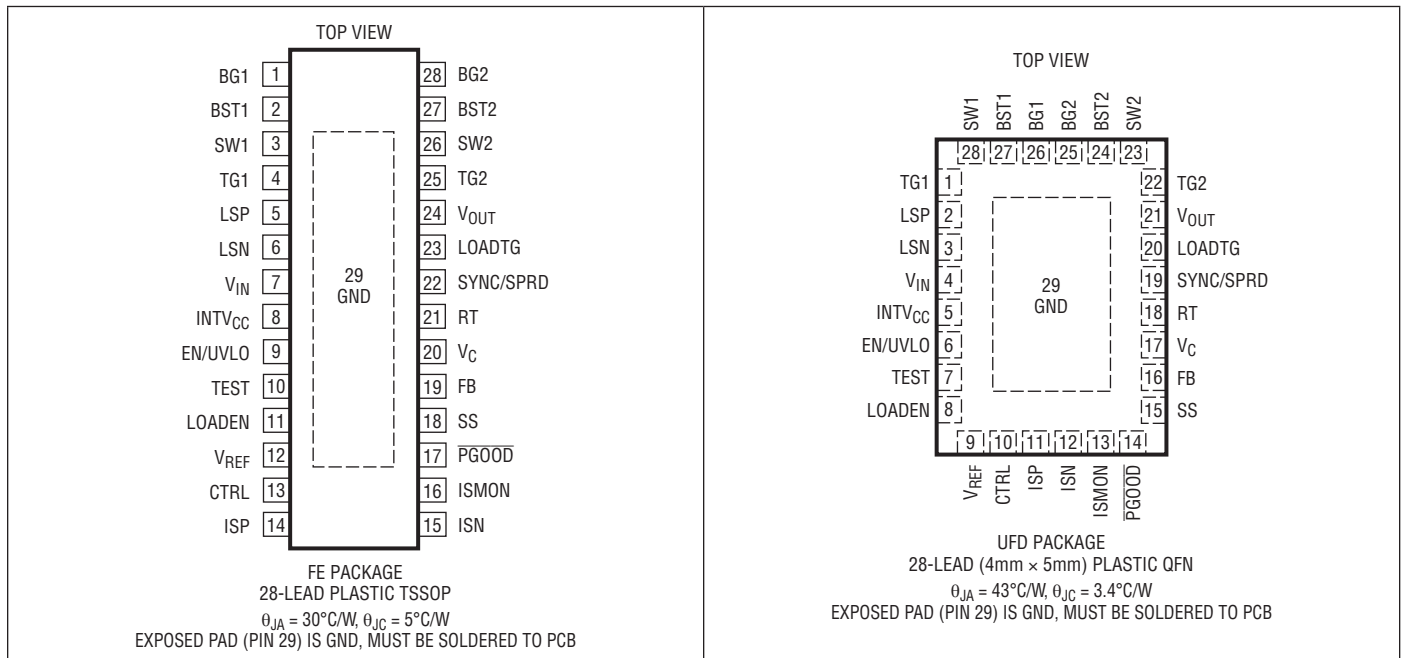

## ORDER INFORMATION <http://www.linear.com/product/LT8390A#orderinfo>

LEAD FREE FINISH	TAPE AND REEL	PART MARKING*	PACKAGE DESCRIPTION	TEMPERATURE RANGE
LT8390AEFE#PBF	LT8390AEFE#TRPBF	LT8390AFE	28-Lead Plastic TSSOP	-40°C to 125°C
LT8390AIFE#PBF	LT8390AIFE#TRPBF	LT8390AFE	28-Lead Plastic TSSOP	-40°C to 125°C
LT8390AHFE#PBF	LT8390AHFE#TRPBF	LT8390AFE	28-Lead Plastic TSSOP	-40°C to 150°C
LT8390AEUFD#PBF	LT8390AEUFD#TRPBF	8390A	28-Lead (4mm x 5mm) Plastic QFN	-40°C to 125°C
LT8390AIUFD#PBF	LT8390AIUFD#TRPBF	8390A	28-Lead (4mm x 5mm) Plastic QFN	-40°C to 125°C
LT8390AHUFD#PBF	LT8390AHUFD#TRPBF	8390A	28-Lead (4mm x 5mm) Plastic QFN	-40°C to 150°C

Consult LTC Marketing for parts specified with wider operating temperature ranges. \*The temperature grade is identified by a label on the shipping container.

For more information on lead free part marking, go to: <http://www.linear.com/leadfree/>

For more information on tape and reel specifications, go to: <http://www.linear.com/tapeandree/>. Some packages are available in 500 unit reels through designated sales channels with #TRMPBF suffix.

**ELECTRICAL CHARACTERISTICS** The ● denotes the specifications which apply over the full operating temperature range, otherwise specifications are at  $T_A = 25^\circ\text{C}$  (Note 2).  $V_{IN} = 12\text{V}$ ,  $V_{EN/UVLO} = 1.5\text{V}$  unless otherwise noted.

PARAMETER	CONDITIONS		MIN	TYP	MAX	UNITS
<b>Supply</b>						
$V_{IN}$ Operating Voltage Range		●	4		60	V
$V_{IN}$ Quiescent Current	$V_{EN/UVLO} = 0.3\text{V}$ $V_{EN/UVLO} = 1.1\text{V}$ Not Switching			1	2	$\mu\text{A}$
				270		$\mu\text{A}$
				2.1	2.8	$\text{mA}$
$V_{OUT}$ Voltage Range		●	0		60	V
$V_{OUT}$ Quiescent Current	$V_{EN/UVLO} = 0.3\text{V}$ , $V_{OUT} = 12\text{V}$ $V_{EN/UVLO} = 1.1\text{V}$ , $V_{OUT} = 12\text{V}$ Not Switching, $V_{OUT} = 12\text{V}$			0.1	0.5	$\mu\text{A}$
				0.1	0.5	$\mu\text{A}$
			20	40	60	$\mu\text{A}$
<b>Linear Regulators</b>						
$\text{INTV}_{CC}$ Regulation Voltage	$I_{\text{INTVCC}} = 20\text{mA}$		4.85	5.0	5.15	V
$\text{INTV}_{CC}$ Load Regulation	$I_{\text{INTVCC}} = 0\text{mA}$ to $80\text{mA}$			1	4	%
$\text{INTV}_{CC}$ Line Regulation	$I_{\text{INTVCC}} = 20\text{mA}$ , $V_{IN} = 6\text{V}$ to $60\text{V}$			1	4	%
$\text{INTV}_{CC}$ Current Limit	$V_{\text{INTVCC}} = 4.5\text{V}$		110	145	190	$\text{mA}$
$\text{INTV}_{CC}$ Dropout Voltage ( $V_{IN} - \text{INTV}_{CC}$ )	$I_{\text{INTVCC}} = 20\text{mA}$ , $V_{IN} = 4\text{V}$			160		$\text{mV}$
$\text{INTV}_{CC}$ Undervoltage Lockout Threshold	Falling		3.44	3.54	3.64	V
$\text{INTV}_{CC}$ Undervoltage Lockout Hysteresis				0.24		V
$V_{REF}$ Regulation Voltage	$I_{VREF} = 100\mu\text{A}$	●	1.97	2.00	2.03	V
$V_{REF}$ Load Regulation	$I_{VREF} = 0\text{mA}$ to $1\text{mA}$			0.4	1	%
$V_{REF}$ Line Regulation	$I_{VREF} = 100\mu\text{A}$ , $V_{IN} = 4\text{V}$ to $60\text{V}$			0.1	0.2	%
$V_{REF}$ Current Limit	$V_{REF} = 1.8\text{V}$		2	2.5	3.2	$\text{mA}$
$V_{REF}$ Undervoltage Lockout Threshold	Falling		1.78	1.84	1.90	V
$V_{REF}$ Undervoltage Lockout Hysteresis				50		$\text{mV}$
<b>Control Inputs/Outputs</b>						
EN/UVLO Shutdown Threshold		●	0.3	0.6	1.0	V
EN/UVLO Enable Threshold	Falling	●	1.196	1.220	1.244	V
EN/UVLO Enable Hysteresis				13		$\text{mV}$
EN/UVLO Hysteresis Current	$V_{EN/UVLO} = 0.3\text{V}$ $V_{EN/UVLO} = 1.1\text{V}$ $V_{EN/UVLO} = 1.3\text{V}$		-0.1	0	0.1	$\mu\text{A}$
			2.1	2.5	2.9	$\mu\text{A}$
			-0.1	0	0.1	$\mu\text{A}$
CTRL Input Bias Current	$V_{CTRL} = 0.75\text{V}$ , Current Out of Pin		0	20	50	$\text{nA}$
CTRL Latch-Off Threshold	Falling	●	285	300	315	$\text{mV}$
CTRL Latch-Off Hysteresis				25		$\text{mV}$
<b>Load Switch Driver</b>						
LOADEN Threshold	Rising	●	1.3	1.4	1.5	V
LOADEN Hysteresis				220		$\text{mV}$
Minimum $V_{OUT}$ for LOADTG to be On	$V_{LOADEN} = 5\text{V}$			2.4	3	V
LOADTG On Voltage $V_{(V_{OUT}-LOADTG)}$	$V_{OUT} = 12\text{V}$		4.5	5	5.5	V
LOADTG Off Voltage $V_{(V_{OUT}-LOADTG)}$	$V_{OUT} = 12\text{V}$		-0.1	0	0.1	V
LOADEN to LOADTG Turn On Propagation Delay	$C_{LOADTG} = 3.3\text{nF}$ to $V_{OUT}$ , 50% to 50%			90		$\text{ns}$
LOADEN to LOADTG Turn Off Propagation Delay	$C_{LOADTG} = 3.3\text{nF}$ to $V_{OUT}$ , 50% to 50%			40		$\text{ns}$
LOADTG Turn On Fall Time	$C_{LOADTG} = 3.3\text{nF}$ to $V_{OUT}$ , 10% to 90%			300		$\text{ns}$
LOADTG Turn Off Rise Time	$C_{LOADTG} = 3.3\text{nF}$ to $V_{OUT}$ , 90% to 10%			10		$\text{ns}$

## ELECTRICAL CHARACTERISTICS

The ● denotes the specifications which apply over the full operating temperature range, otherwise specifications are at  $T_A = 25^\circ\text{C}$  (Note 2).  $V_{IN} = 12\text{V}$ ,  $V_{EN/UVLO} = 1.5\text{V}$  unless otherwise noted.

PARAMETER	CONDITIONS		MIN	TYP	MAX	UNITS
<b>Error Amplifier</b>						
Full Scale Current Regulation $V_{(ISP-ISN)}$	$V_{CTRL} = 2\text{V}$ , $V_{ISP} = 12\text{V}$	●	97	100	103	mV
	$V_{CTRL} = 2\text{V}$ , $V_{ISP} = 0\text{V}$	●	97	100	103	mV
1/10th Current Regulation $V_{(ISP-ISN)}$	$V_{CTRL} = 0.35\text{V}$ , $V_{ISP} = 12\text{V}$	●	8	10	12	mV
	$V_{CTRL} = 0.35\text{V}$ , $V_{ISP} = 0\text{V}$	●	8	10	12	mV
ISMON Monitor Output $V_{ISMON}$	$V_{(ISP-ISN)} = 100\text{mV}$ , $V_{ISP} = 12\text{V}/0\text{V}$	●	1.20	1.25	1.30	V
	$V_{(ISP-ISN)} = 10\text{mV}$ , $V_{ISP} = 12\text{V}/0\text{V}$	●	0.30	0.35	0.40	V
	$V_{(ISP-ISN)} = 0\text{mV}$ , $V_{ISP} = 12\text{V}/0\text{V}$	●	0.20	0.25	0.30	V
ISP/ISN Input Common Mode Range		●	0		60	V
ISP/ISN Low Side to High Side Switchover Voltage	$V_{ISP} = V_{ISN}$			1.8		V
ISP/ISN High Side to Low Side Switchover Voltage	$V_{ISP} = V_{ISN}$			1.7		V
ISP Input Bias Current	$V_{LOADEN} = 5\text{V}$ , $V_{ISP} = V_{ISN} = 12\text{V}$			23		$\mu\text{A}$
	$V_{LOADEN} = 5\text{V}$ , $V_{ISP} = V_{ISN} = 0\text{V}$			-10		$\mu\text{A}$
	$V_{EN/UVLO} = 0\text{V}$ , $V_{ISP} = V_{ISN} = 12\text{V}$ or $0\text{V}$			0		$\mu\text{A}$
ISN Input Bias Current	$V_{LOADEN} = 5\text{V}$ , $V_{ISP} = V_{ISN} = 12\text{V}$			23		$\mu\text{A}$
	$V_{LOADEN} = 5\text{V}$ , $V_{ISP} = V_{ISN} = 0\text{V}$			-10		$\mu\text{A}$
	$V_{EN/UVLO} = 0\text{V}$ , $V_{ISP} = V_{ISN} = 12\text{V}$ or $0\text{V}$			0		$\mu\text{A}$
ISP/ISN Current Regulation Amplifier $g_m$				2000		$\mu\text{s}$
FB Regulation Voltage	$V_C = 1.2\text{V}$	●	0.985	1.00	1.015	V
FB Line Regulation	$V_{IN} = 4\text{V}$ to $60\text{V}$			0.2	0.5	%
FB Load Regulation				0.2	0.8	%
FB Voltage Regulation Amplifier $g_m$				660		$\mu\text{S}$
FB Input Bias Current	FB in Regulation, Current Out of Pin			10	40	nA
$V_C$ Output Impedance				10		$\text{M}\Omega$
$V_C$ Standby Leakage Current	$V_C = 1.2\text{V}$ , $V_{LOADEN} = 0\text{V}$		-10	0	10	nA
<b>Current Comparator</b>						
Maximum Current Sense Threshold $V_{(LSP-LSN)}$	Buck, $V_{FB} = 0.8\text{V}$	●	35	50	65	mV
	Boost, $V_{FB} = 0.8\text{V}$	●	40	50	60	mV
LSP Pin Bias Current	$V_{LSP} = V_{LSN} = 12\text{V}$			60		$\mu\text{A}$
LSN Pin Bias Current	$V_{LSP} = V_{LSN} = 12\text{V}$			60		$\mu\text{A}$
<b>Fault</b>						
FB Overvoltage Threshold ( $V_{FB}$ )	Rising	●	1.08	1.1	1.12	V
FB Overvoltage Hysteresis		●	35	50	65	mV
FB Short Threshold ( $V_{FB}$ )	Falling	●	0.24	0.25	0.26	V
FB Short Hysteresis	Hysteresis	●	35	50	65	mV
ISP/ISN Over Current Threshold $V_{(ISP-ISN)}$	$V_{ISP} = 12\text{V}$			750		mV
$\overline{\text{PGOOD}}$ Upper Threshold Offset from $V_{FB}$	Rising	●	8	10	12	%
$\overline{\text{PGOOD}}$ Lower Threshold Offset from $V_{FB}$	Falling	●	-12	-10	-8	%
$\overline{\text{PGOOD}}$ Pull-Down Resistance				100	200	$\Omega$
SS Hard Pull-Down Resistance	$V_{EN/UVLO} = 1.1\text{V}$			100	200	$\Omega$
SS Pull-Up Current	$V_{FB} = 0.4\text{V}$ , $V_{SS} = 0\text{V}$		10	12.5	15	$\mu\text{A}$
SS Pull-Down Current	$V_{FB} = 0.1\text{V}$ , $V_{SS} = 2\text{V}$		1	1.25	1.5	$\mu\text{A}$
SS Fault Latch-Off Threshold				1.7		V
SS Fault Reset Threshold				0.2		V

**ELECTRICAL CHARACTERISTICS** The ● denotes the specifications which apply over the full operating temperature range, otherwise specifications are at  $T_A = 25^\circ\text{C}$  (Note 2).  $V_{IN} = 12\text{V}$ ,  $V_{EN/UVLO} = 1.5\text{V}$  unless otherwise noted.

PARAMETER	CONDITIONS	MIN	TYP	MAX	UNITS
<b>Oscillator</b>					
RT Pin Voltage	$R_T = 100\text{k}\Omega$		1.00		V
Switching Frequency	$V_{\text{SYNC/SPRD}} = 0\text{V}$ , $R_T = 226\text{k}\Omega$	645	685	725	kHz
	$V_{\text{SYNC/SPRD}} = 0\text{V}$ , $R_T = 100\text{k}\Omega$	1290	1360	1430	
	$V_{\text{SYNC/SPRD}} = 0\text{V}$ , $R_T = 59.0\text{k}\Omega$ ●	1900	2000	2100	
SYNC Frequency		600		2100	kHz
SYNC/SPRD Input Bias Current	$V_{\text{SYNC/SPRD}} = 5\text{V}$	-0.1	0	0.1	$\mu\text{A}$
SYNC/SPRD Threshold Voltage		0.4		1.5	V
Highest Spread Spectrum Above Oscillator Frequency	$V_{\text{SYNC/SPRD}} = 5\text{V}$	21	23	25	%
<b>Region Transition</b>					
Buck-Boost to Boost ( $V_{IN}/V_{OUT}$ )		0.73	0.75	0.77	
Boost to Buck-Boost ( $V_{IN}/V_{OUT}$ )		0.83	0.85	0.87	
Buck to Buck-Boost ( $V_{IN}/V_{OUT}$ )		1.23	1.25	1.27	
Buck-Boost to Buck ( $V_{IN}/V_{OUT}$ )		1.31	1.33	1.35	
Peak-Buck to Peak-Boost ( $V_{IN}/V_{OUT}$ )		0.96	0.98	1.00	
Peak-Boost to Peak-Buck ( $V_{IN}/V_{OUT}$ )		1.00	1.02	1.04	
<b>NMOS Drivers</b>					
TG1, TG2 Gate Driver On-Resistance Gate Pull-Up Gate Pull-Down	$V_{(\text{BST-SW})} = 5\text{V}$		2.6		$\Omega$
			1.4		$\Omega$
BG1, BG2 Gate Driver On-Resistance Gate Pull-Up Gate Pull-Down	$V_{\text{INTVCC}} = 5\text{V}$		3.2		$\Omega$
			1.2		$\Omega$
TG1, TG2 Rise Time	$C_L = 3.3\text{nF}$ , 10% to 90%		25		ns
TG1, TG2 Fall Time	$C_L = 3.3\text{nF}$ , 90% to 10%		20		ns
BG1, BG2 Rise Time	$C_L = 3.3\text{nF}$ , 10% to 90%		25		ns
BG1, BG2 Fall Time	$C_L = 3.3\text{nF}$ , 90% to 10%		20		ns
TG Off to BG On Delay	$C_L = 3.3\text{nF}$		25		ns
BG Off to TG On Delay	$C_L = 3.3\text{nF}$		25		ns
TG1 Minimum Duty Cycle in Buck Region	Peak-Buck Current Mode		10		%
TG1 Maximum Duty Cycle in Buck Region	Peak-Buck Current Mode		90		%
TG1 Fixed Duty Cycle in Buck-Boost Region	Peak-Boost Current Mode		80		%
BG2 Fixed Duty Cycle in Buck-Boost Region	Peak-Buck Current Mode		20		%
BG2 Minimum Duty Cycle in Boost Region	Peak-Boost Current Mode		10		%
BG2 Maximum Duty Cycle in Boost Region	Peak-Boost Current Mode		90		%

**Note 1:** Stresses beyond those listed under Absolute Maximum Ratings may cause permanent damage to the device. Exposure to any Absolute Maximum Rating condition for extended periods may affect device reliability and lifetime.

**Note 2:** The LT8390AE is guaranteed to meet performance specifications from  $0^\circ\text{C}$  to  $125^\circ\text{C}$  operating junction temperature. Specifications over the  $-40^\circ\text{C}$  to  $125^\circ\text{C}$  operating junction temperature range are assured by design, characterization and correlation with statistical process controls. The LT8390AI is guaranteed over the  $-40^\circ\text{C}$  to  $125^\circ\text{C}$  operating junction

temperature range. The LT8390AH is guaranteed over the  $-40^\circ\text{C}$  to  $150^\circ\text{C}$  operating junction temperature range. High junction temperatures degrade operating lifetimes. Operating lifetime is derated at junction temperatures greater than  $125^\circ\text{C}$ .

**Note 3:** The LT8390A includes overtemperature protection that is intended to protect the device during momentary overload conditions. Junction temperature will exceed  $150^\circ\text{C}$  when overtemperature protection is active. Continuous operation above the specified absolute maximum operating junction temperature may impair device reliability.

## TYPICAL PERFORMANCE CHARACTERISTICS $T_A = 25^\circ\text{C}$ , unless otherwise noted.

### Efficiency vs Load Current (Buck Region)

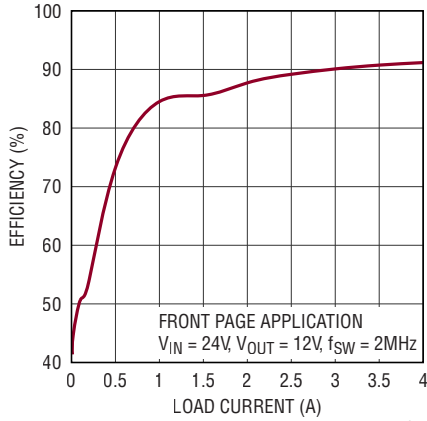

### Efficiency vs Load Current (Buck-Boost Region)

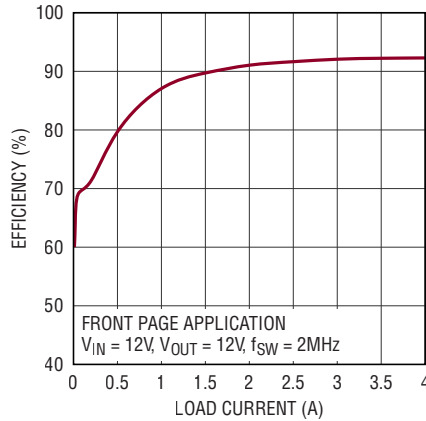

### Efficiency vs Load Current (Boost Region)

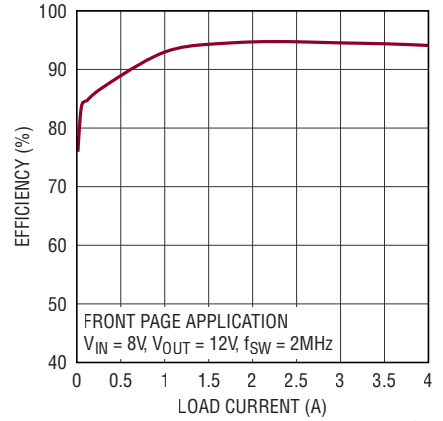

### Switching Waveforms (Buck Region)

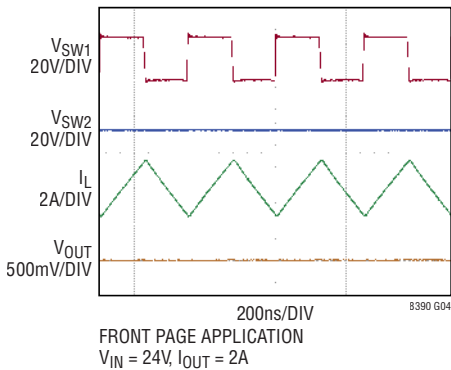

### Switching Waveforms (Buck-Boost Region)

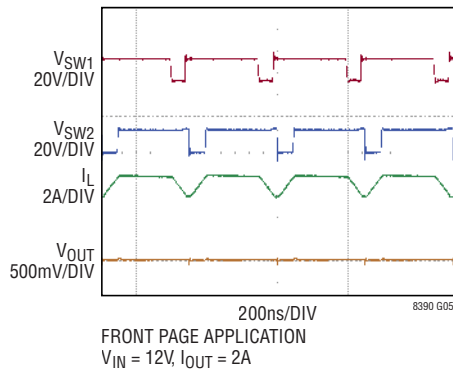

### Switching Waveforms (Boost Region)

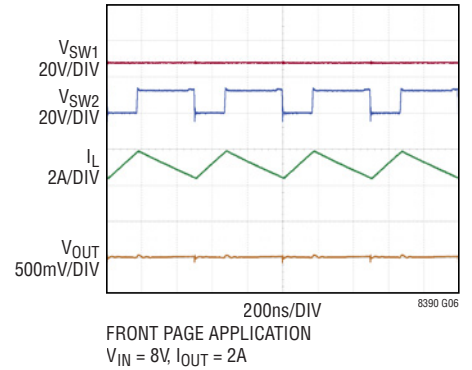

### $V_{OUT}$ vs $I_{OUT}$ (CV/CC)

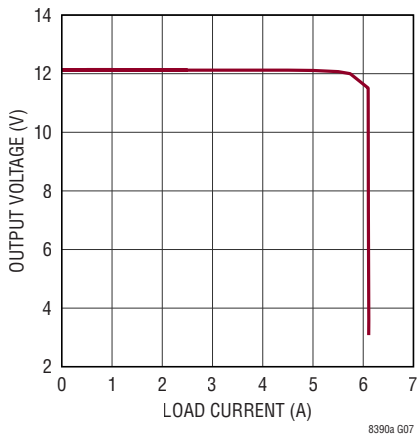

### $V_{IN}$ Shutdown Current

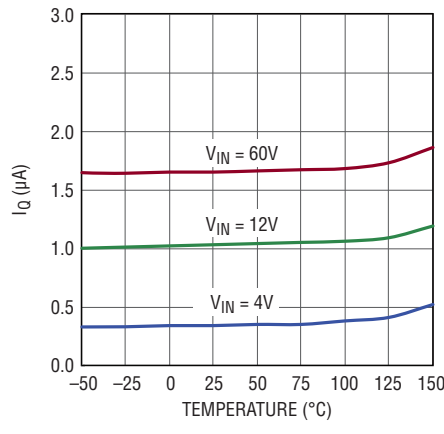

### $V_{IN}$ Quiescent Current

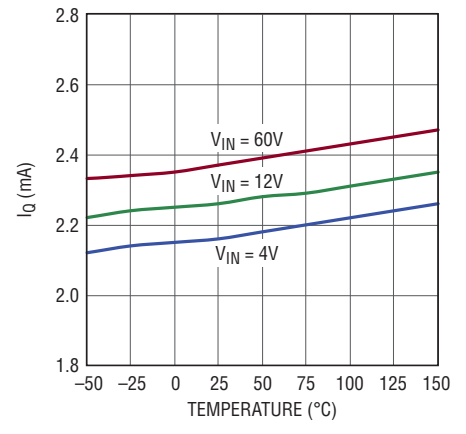

**TYPICAL PERFORMANCE CHARACTERISTICS**  $T_A = 25^\circ\text{C}$ , unless otherwise noted.

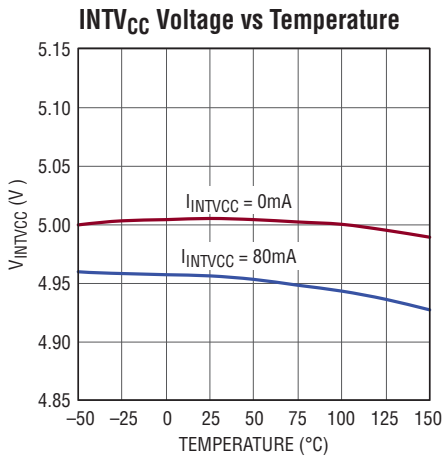

8390a G10

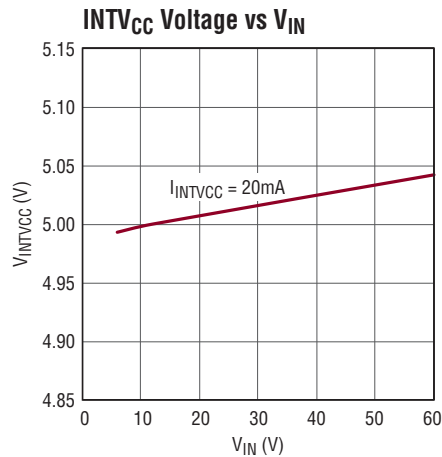

8390a G11

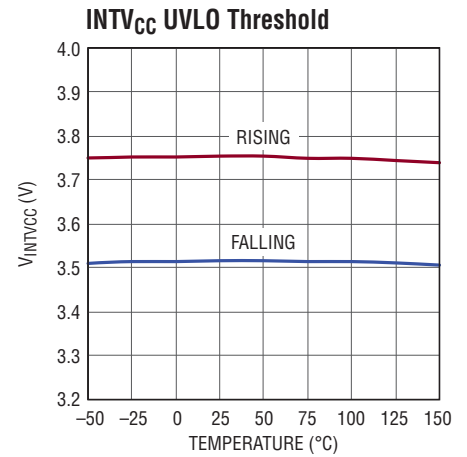

8390a G12

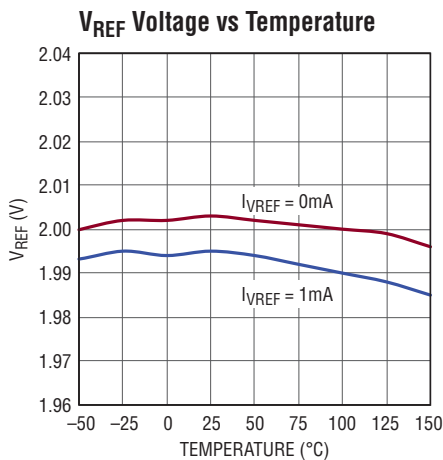

8390a G13

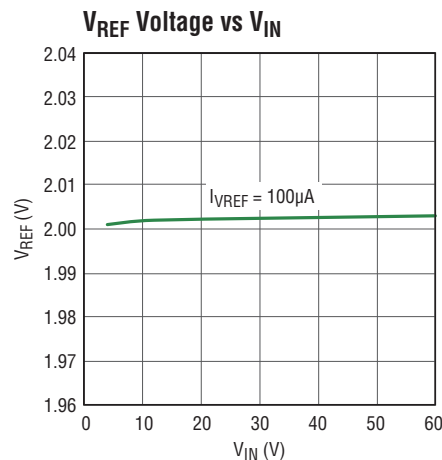

8390a G14

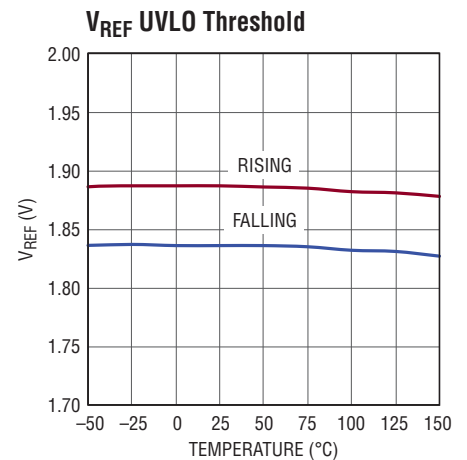

8390a G15

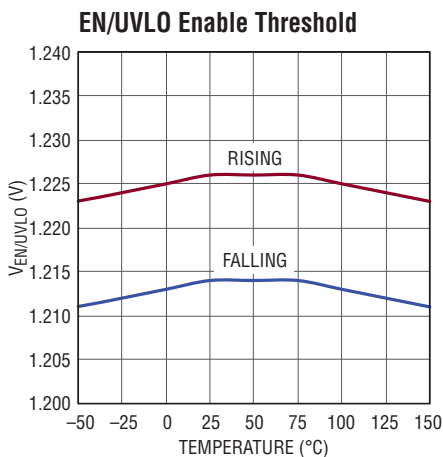

8390a G16

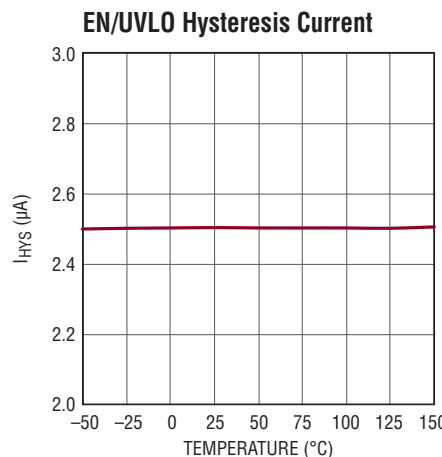

8390a G17

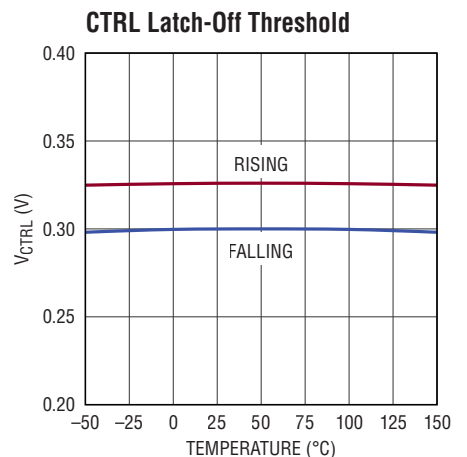

8390a G18

## TYPICAL PERFORMANCE CHARACTERISTICS $T_A = 25^\circ\text{C}$ , unless otherwise noted.

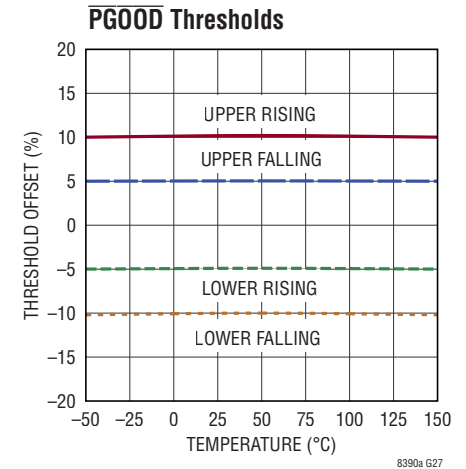
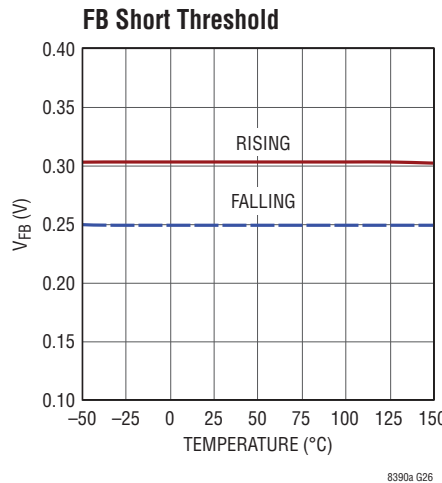
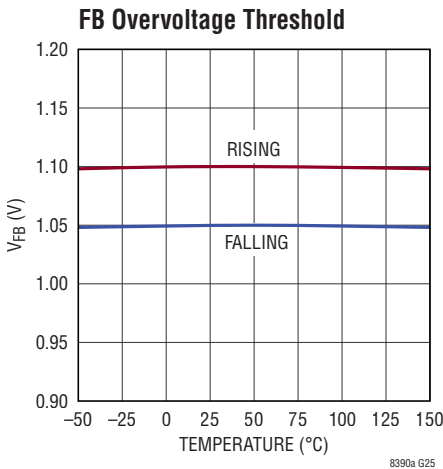
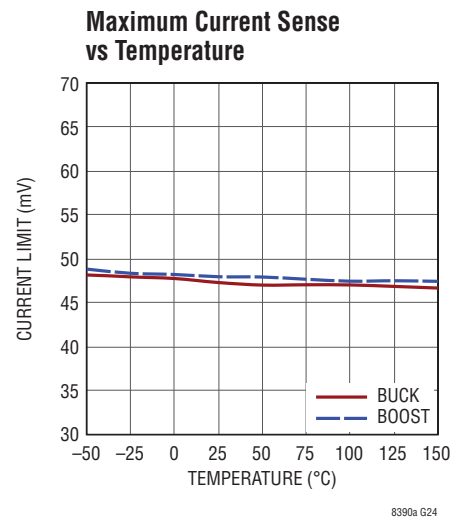
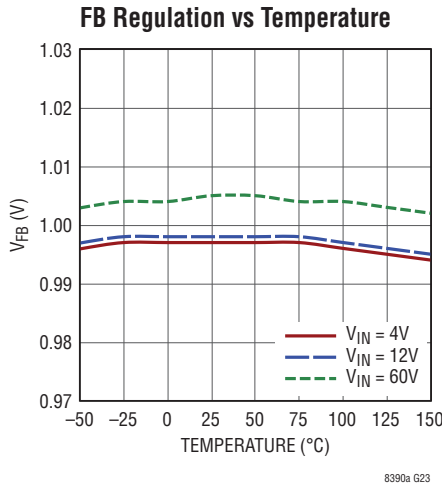
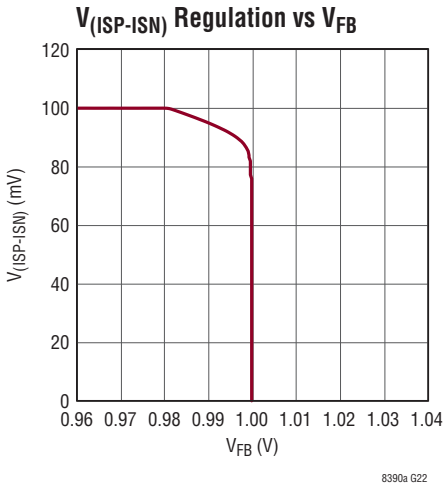
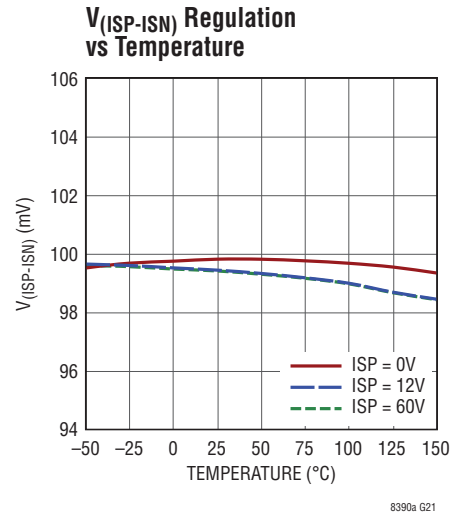
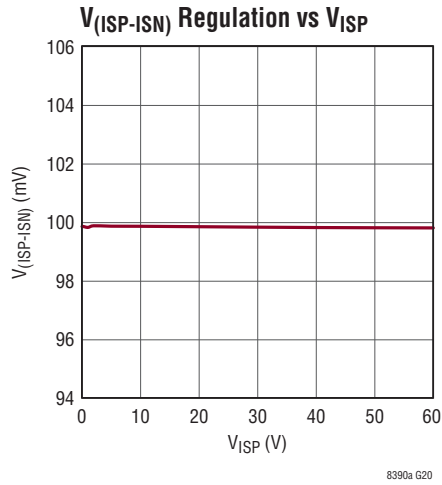
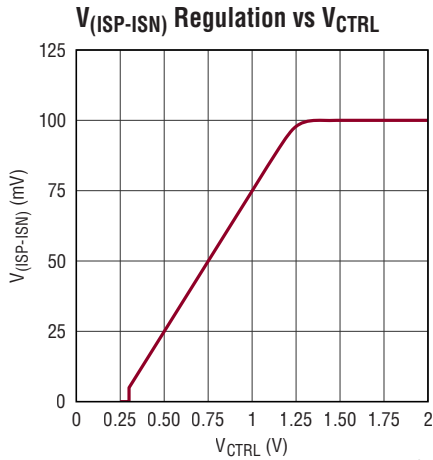



**TYPICAL PERFORMANCE CHARACTERISTICS**  $T_A = 25^\circ\text{C}$ , unless otherwise noted.

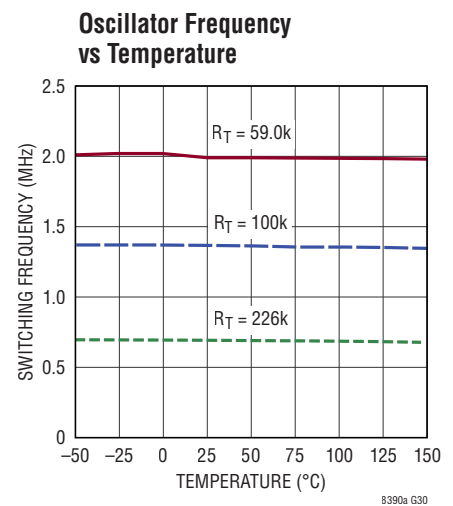
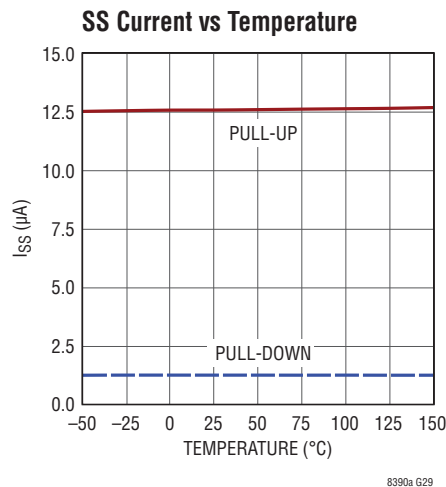
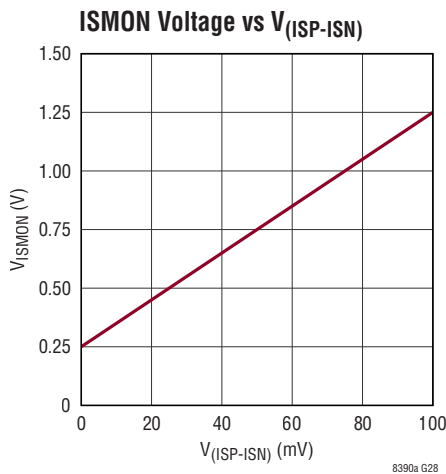

**PIN FUNCTIONS**

**BG1:** Buck Side Bottom Gate Drive. Drives the gate of buck side bottom N-channel MOSFET with a voltage swing from ground to  $INTV_{CC}$ .

**BST1:** Buck Side Bootstrap Floating Driver Supply. The BST1 pin has an integrated bootstrap Schottky diode from the  $INTV_{CC}$  pin and requires an external bootstrap capacitor to the SW1 pin. The BST1 pin swings from a diode voltage drop below  $INTV_{CC}$  to  $(V_{IN} + INTV_{CC})$ .

**SW1:** Buck Side Switch Node. The SW1 pin swings from a Schottky diode voltage drop below ground up to  $V_{IN}$ .

**TG1:** Buck Side Top Gate Drive. Drives the gate of buck side top N-channel MOSFET with a voltage swing from SW1 to BST1.

**LSP:** Positive Terminal of the Buck Side Inductor Current Sense Resistor ( $R_{SENSE}$ ). Ensure accurate current sense with Kelvin connection.

**LSN:** Negative Terminal of the Buck Side Inductor Current Sense Resistor ( $R_{SENSE}$ ). Ensure accurate current sense with Kelvin connection.

**$V_{IN}$ :** Input Supply. The  $V_{IN}$  pin must be tied to the power input to determine the buck, buck-boost, or boost operation regions. Locally bypass this pin to ground with a minimum  $1\mu\text{F}$  ceramic capacitor.

**$INTV_{CC}$ :** Internal 5V Linear Regulator Output. The  $INTV_{CC}$  linear regulator is supplied from the  $V_{IN}$  pin, and powers the internal control circuitry and gate drivers. Locally bypass this pin to ground with a minimum  $4.7\mu\text{F}$  ceramic capacitor.

**EN/UVLO:** Enable and Undervoltage Lockout. Force the pin below  $0.3\text{V}$  to shut down the part and reduce  $V_{IN}$  quiescent current below  $2\mu\text{A}$ . Force the pin above  $1.233\text{V}$  for normal operation. The accurate  $1.220\text{V}$  falling threshold can be used to program an undervoltage lockout (UVLO) threshold with a resistor divider from  $V_{IN}$  to ground. An accurate  $2.5\mu\text{A}$  pull-down current allows the programming of  $V_{IN}$  UVLO hysteresis. If neither function is used, tie this pin directly to  $V_{IN}$ .

**TEST:** Factory Test. This pin is used for testing purpose only and must be directly connected to ground for the part to operate properly.

**LOADEN:** Load Switch Enable Input. The LOADEN pin is used to control the ON/OFF of the high side PMOS load switch. If the load switch control is not used, tie this pin to  $V_{REF}$  or  $INTV_{CC}$ . Forcing the pin low turns off TG1 and TG2, turns on BG1 and BG2, disconnects the  $V_C$  pin from all internal loads, and turns off LOADTG.

**$V_{REF}$ :** Voltage Reference Output. The  $V_{REF}$  pin provides an accurate  $2\text{V}$  reference capable of supplying  $1\text{mA}$  current. Locally bypass this pin to ground with a  $0.47\mu\text{F}$  ceramic capacitor.

## PIN FUNCTIONS

**CTRL:** Control Input for ISP/ISN Current Sense Threshold. The CTRL pin is used to program the ISP/ISN current limit:

$$I_{IS(MAX)} = \frac{\text{Min}(V_{CTRL} - 0.25V, 1V)}{10 \cdot R_{IS}}$$

The  $V_{CTRL}$  can be set by an external voltage reference or a resistor divider from  $V_{REF}$  to ground. For  $0.3V \leq V_{CTRL} \leq 1.15V$ , the current sense threshold linearly goes up from 5mV to 90mV. For  $V_{CTRL} \geq 1.35V$ , the current sense threshold is constant at 100mV full scale value. For  $1.15V \leq V_{CTRL} \leq 1.35V$ , the current sense threshold smoothly transitions from the linear function of  $V_{CTRL}$  to the 100mV constant value. Tie CTRL to  $V_{REF}$  for the 100mV full scale threshold. Force the pin below 0.3V to stop switching.

**ISP:** Positive Terminal of the ISP/ISN Current Sense Resistor ( $R_{IS}$ ). Ensure accurate current sense with Kelvin connection.

**ISN:** Negative Terminal of the ISP/ISN Current Sense Resistor ( $R_{IS}$ ). Ensure accurate current sense with Kelvin connection.

**ISMON:** ISP/ISN Current Sense Monitor Output. The ISMON pin generates a voltage that is equal to ten times  $V_{(ISP-ISN)}$  plus 0.25V offset voltage. For parallel applications, tie the master LT8390A ISMON pin to the slave LT8390A CTRL pin.

**PGOOD:** Power Good Open Drain Output. The  $\overline{\text{PGOOD}}$  pin is pulled low when the FB pin is within  $\pm 10\%$  of the final regulation voltage. To function, the pin requires an external pull-up resistor.

**SS:** Soft-Start Timer Setting. The SS pin is used to set soft-start timer by connecting a capacitor to ground. An internal 12.5 $\mu$ A pull-up current charging the external SS capacitor gradually ramps up FB regulation voltage. A 22nF capacitor is recommended on this pin. Any UVLO or thermal shutdown immediately pulls SS pin to ground and stops switching. Using a single resistor from SS to  $V_{REF}$ , the LT8390A can be set in three different fault protection modes during output short-circuit condition: hiccup (no resistor), latch-off (499k $\Omega$ ), and keep-running (100k $\Omega$ ). See more details in the Application Information section.

**FB:** Voltage Loop Feedback Input. The FB pin is used for constant-voltage regulation and output fault protection. The internal error amplifier with its output  $V_C$  regulates  $V_{FB}$  to 1.00V through the DC/DC converter. During output

short-circuit ( $V_{FB} < 0.25V$ ) condition, the part gets into one fault mode per customer setting. During an overvoltage ( $V_{FB} > 1.1V$ ) condition, the part turns off all TG1, BG1, TG2, BG2, and LOADTG.

**$V_C$ :** Error Amplifier Output to Set Inductor Current Comparator Threshold. The  $V_C$  pin is used to compensate the control loop with an external RC network. During LOADEN low state, the  $V_C$  pin is disconnected from all internal loads to store its voltage information.

**RT:** Switching Frequency Setting. Connect a resistor from this pin to ground to set the internal oscillator frequency from 600kHz to 2MHz.

**SYNC/SPRD:** Switching Frequency Synchronization or Spread Spectrum. Ground this pin for switching at internal oscillator frequency. Apply a clock signal for external frequency synchronization. Tie to  $\text{INTV}_{CC}$  for 25% triangle spread spectrum above internal oscillator frequency.

**LOADTG:** High Side PMOS Load Switch Top Gate Drive. A buffered and inverted version of the LOADEN input signal, the LOADTG pin drives an external high side PMOS load switch with a voltage swing from the higher voltage of ( $V_{OUT} - 5V$ ) and 1.2V to  $V_{OUT}$ . Leave this pin unconnected if not used.

**$V_{OUT}$ :** Output Supply. The  $V_{OUT}$  pin must be tied to the power output to determine the buck, buck-boost, or boost operation regions. The  $V_{OUT}$  pin also serves as positive rail for the LOADTG drive. Locally bypass this pin to ground with a minimum 1 $\mu$ F ceramic capacitor.

**TG2:** Boost Side Top Gate Drive. Drives the gate of boost side top N-Channel MOSFET with a voltage swing from SW2 to BST2.

**SW2:** Boost Side Switch Node. The SW2 pin swings from a Schottky diode voltage drop below ground to  $V_{OUT}$ .

**BST2:** Boost Side Bootstrap Floating Driver Supply. The BST2 pin has an integrated bootstrap Schottky diode from the  $\text{INTV}_{CC}$  pin and requires an external bootstrap capacitor to the SW2 pin. The BST2 pin swings from a diode voltage drop below  $\text{INTV}_{CC}$  to ( $V_{OUT} + \text{INTV}_{CC}$ ).

**BG2:** Boost Side Bottom Gate Drive. Drives the gate of boost side bottom N-channel MOSFET with a voltage swing from ground to  $\text{INTV}_{CC}$ .

**GND (Exposed Pad):** Ground. Solder the exposed pad directly to the ground plane.

**BLOCK DIAGRAM**

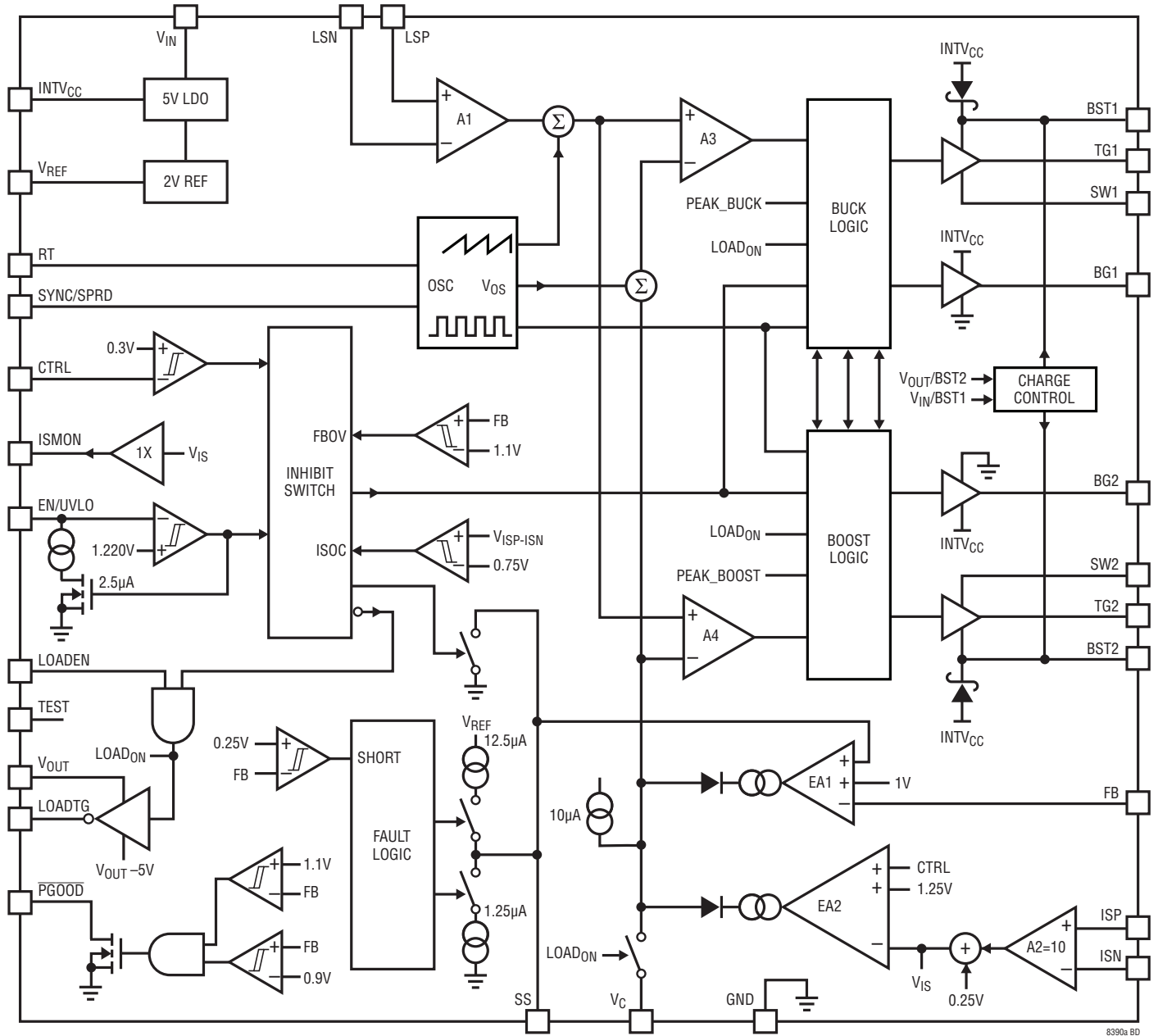

## OPERATION

The LT8390A is a current mode DC/DC controller that can regulate output voltage, input or output current from input voltage above, below, or equal to the output voltage. The LTC proprietary peak-buck peak-boost current mode control scheme uses a single inductor current sense resistor and provides smooth transition between buck region, buck-boost region, and boost region. Its operation is best understood by referring to the Block Diagram.

### Power Switch Control

Figure 1 shows a simplified diagram of how the four power switches A, B, C, and D are connected to the inductor L, the current sense resistor  $R_{SENSE}$ , power input  $V_{IN}$ , power output  $V_{OUT}$ , and ground. The current sense resistor  $R_{SENSE}$  connected to the LSP and LSN pins provides inductor current information for both peak current mode control and reverse current detection in buck region, buck-boost region, and boost region. Figure 2 shows the current mode control as a function of  $V_{IN}/V_{OUT}$  ratio and Figure 3 shows the operation region as a function of  $V_{IN}/V_{OUT}$  ratio. The power switches are properly controlled to smoothly transition between modes and regions. Hysteresis is added to prevent chattering between modes and regions.

There are total four states: (1) peak-buck current mode control in buck region, (2) peak-buck current mode control in buck-boost region, (3) peak-boost current mode control in buck-boost region, and (4) peak-boost current mode control in boost region. The following sections give detailed description for each state with waveforms, in which the shoot-through protection dead time between switches A and B, between switches C and D are ignored for simplification.

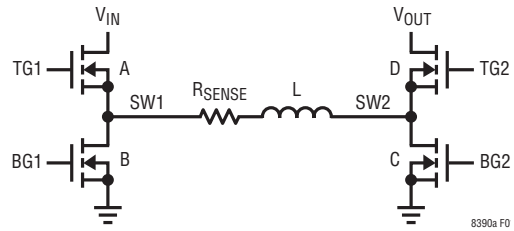

Figure 1. Simplified Diagram of the Power Switches

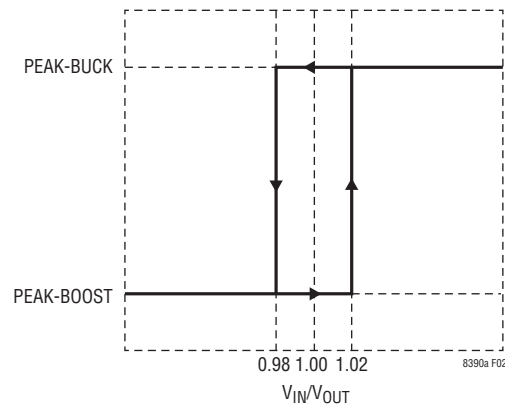

Figure 2. Current Mode vs  $V_{IN}/V_{OUT}$  Ratio

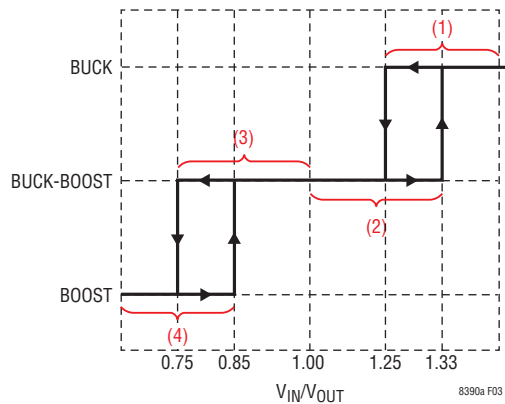

Figure 3. Operation Region vs  $V_{IN}/V_{OUT}$  Ratio

## OPERATION

### (1) Peak-Buck in Buck Region ( $V_{IN} \gg V_{OUT}$ )

When  $V_{IN}$  is much higher than  $V_{OUT}$ , the LT8390A uses peak-buck current mode control in buck region (Figure 4). Switch C is always off and switch D is always on. At the beginning of every cycle, switch A is turned on and the inductor current ramps up. When the inductor current hits the peak buck current threshold commanded by  $V_C$  voltage at buck current comparator A3 during (A+D) phase, switch A is turned off and switch B is turned on for the rest of the cycle. Switches A and B will alternate, behaving like a typical synchronous buck regulator.

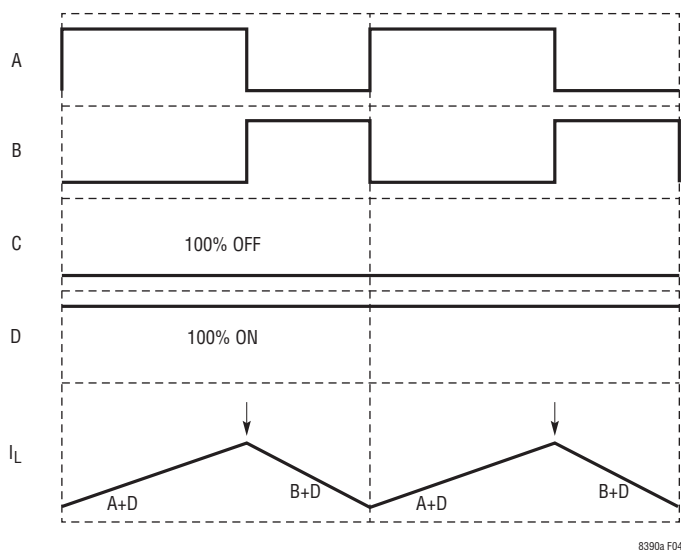

Figure 4. Peak-Buck in Buck Region ( $V_{IN} \gg V_{OUT}$ )

### (2) Peak-Buck in Buck-Boost Region ( $V_{IN} \sim V_{OUT}$ )

When  $V_{IN}$  is slightly higher than  $V_{OUT}$ , the LT8390A uses peak-buck current mode control in buck-boost region (Figure 5). Switch C is always turned on for the beginning 20% cycle and switch D is always turned on for the remaining 80% cycle. At the beginning of every cycle, switches A and C are turned on and the inductor current ramps up. After 20% cycle, switch C is turned off and switch D is turned on, and the inductor keeps ramping up. When the inductor current hits the peak buck current threshold commanded by  $V_C$  voltage at buck current comparator A3 during (A+D) phase, switch A is turned off and switch B is turned on for the rest of the cycle.

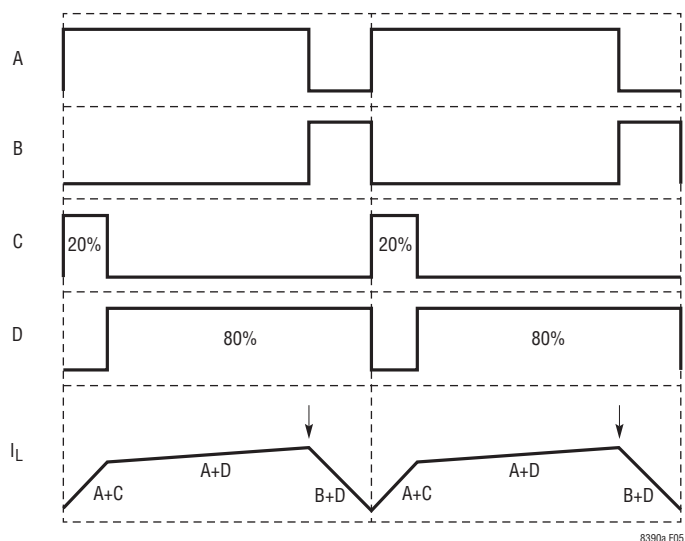

Figure 5. Peak-Buck in Buck-Boost Region ( $V_{IN} \sim V_{OUT}$ )

## OPERATION

### (3) Peak-Boost in Buck-Boost Region ( $V_{IN} \sim V_{OUT}$ )

When  $V_{IN}$  is slightly lower than  $V_{OUT}$ , the LT8390A uses peak-boost current mode control in buck-boost region (Figure 6). Switch A is always turned on for the beginning 80% cycle and switch B is always turned on for the remaining 20% cycle. At the beginning of every cycle, switches A and C are turned on and the inductor current ramps up. When the inductor current hits the peak boost current threshold commanded by  $V_C$  voltage at boost current comparator A4 during (A+C) phase, switch C is turned off and switch D is turned on for the rest of the cycle. After 80% cycle, switch A is turned off and switch B is turned on for the rest of the cycle.

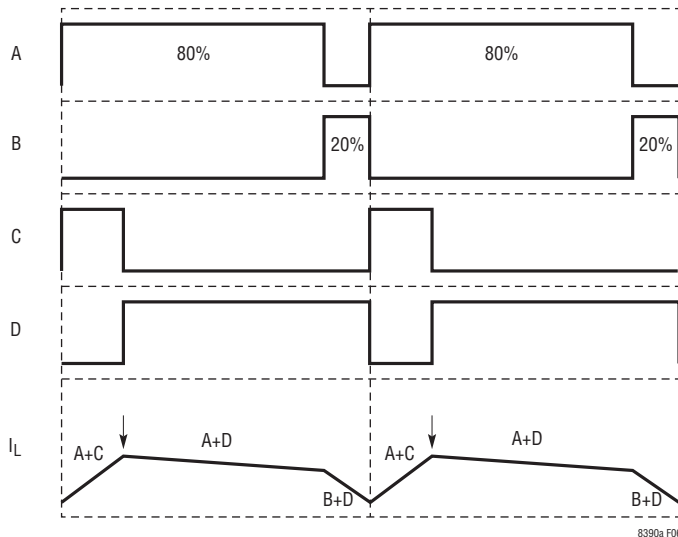

Figure 6. Peak-Boost in Buck-Boost Region ( $V_{IN} \sim V_{OUT}$ )

### (4) Peak-Boost in Boost Region ( $V_{IN} \ll V_{OUT}$ )

When  $V_{IN}$  is much lower than  $V_{OUT}$ , the LT8390A uses peak-boost current mode control in boost region (Figure 7). Switch A is always on and switch B is always off. At the beginning of every cycle, switch C is turned on and the inductor current ramps up. When the inductor current hits the peak boost current threshold commanded by  $V_C$  voltage at boost current comparator A4 during (A+C) phase, switch C is turned off and switch D is turned on for the rest of the cycle. Switches C and D will alternate, behaving like a typical synchronous boost regulator.

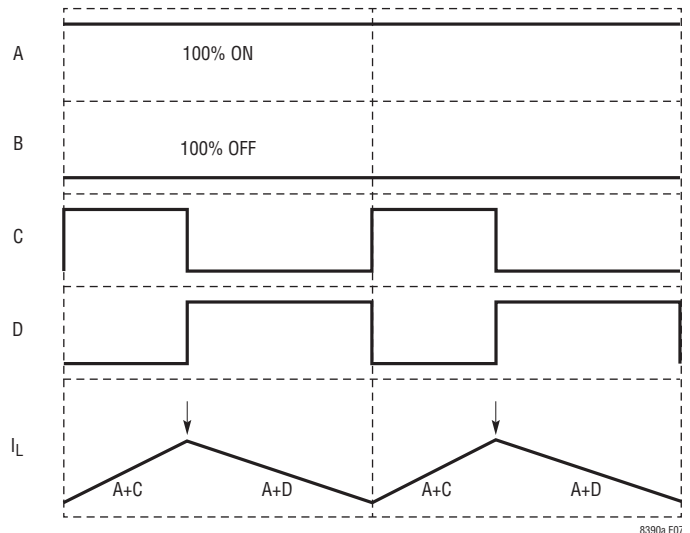

Figure 7. Peak-Boost in Boost Region ( $V_{IN} \ll V_{OUT}$ )

## OPERATION

### Main Control Loop

The LT8390A is a fixed frequency current mode controller. The inductor current is sensed through the inductor sense resistor between the LSP and LSN pins. The current sense voltage is gained up by amplifier A1 and added to a slope compensation ramp signal from the internal oscillator. The summing signal is then fed into the positive terminals of the buck current comparator A3 and boost current comparator A4. The negative terminals of A3 and A4 are controlled by the voltage on the  $V_C$  pin, which is the diode-OR of error amplifiers EA1 and EA2.

Depending on the state of the peak-buck peak-boost current mode control, either the buck logic or the boost logic is controlling the four power switches so that either the FB voltage is regulated to 1V or the current sense voltage between the ISP and ISN pins is regulated by the CTRL pin during normal operation. The gains of EA1 and EA2 have been balanced to ensure smooth transition between constant-voltage and constant-current operation with the same compensation network.

### Light Load Current Operation

At light load, the LT8390A runs either at full switching frequency discontinuous conduction mode or pulse-skipping mode, where the switches are held off for multiple cycles (i.e., skipping pulses) to maintain the regulation and improve the efficiency. Both the buck and boost reverse current sense thresholds are set to 1mV (typical) so that no reverse inductor current is allowed. Such no reverse inductor current from the output to the input is highly desired in certain applications.

In the buck region, switch B is turned off whenever the buck reverse current threshold is triggered during (B+D) phase. In the boost region, switch D is turned off whenever the boost reverse current threshold is triggered during (A+D) phase. In the buck-boost region, switch D is turned off whenever the boost reverse current threshold is triggered during (A+D) phase, and both switches B and D are turned off whenever the buck reverse current threshold is triggered during (B+D) phase.

### Internal Charge Path

Each of the two top MOSFET drivers is biased from its floating bootstrap capacitor, which is normally re-charged by  $INTV_{CC}$  through both the external and internal bootstrap diodes when the top MOSFET is turned off. When the LT8390A operates exclusively in the buck or boost regions, one of the top MOSFETs is constantly on. An internal charge path, from  $V_{OUT}$  and BST2 to BST1 or from  $V_{IN}$  and BST1 to BST2, charges the bootstrap capacitor to 4.6V so that the top MOSFET can be kept on.

### Shutdown and Power-On-Reset

The LT8390A enters shutdown mode and drains less than 2 $\mu$ A quiescent current when the EN/UVLO pin is below its shutdown threshold (0.3V minimum). Once the EN/UVLO pin is above its shutdown threshold (1V maximum), the LT8390A wakes up startup circuitry, generates bandgap reference, and powers up the internal  $INTV_{CC}$  LDO. The  $INTV_{CC}$  LDO supplies the internal control circuitry and gate drivers. Now the LT8390A enters undervoltage lockout (UVLO) mode with a hysteresis current (2.5 $\mu$ A typical) pulled into the EN/UVLO pin. When the  $INTV_{CC}$  pin is charged above its rising UVLO threshold (3.78V typical), the EN/UVLO pin passes its rising enable threshold (1.233V typical), and the junction temperature is less than its thermal shutdown (165°C typical), the LT8390A enters enable mode, in which the EN/UVLO hysteresis current is turned off and the voltage reference  $V_{REF}$  is being charged up from ground. From the time of entering enable mode to the time of  $V_{REF}$  passing its rising UVLO threshold (1.89V typical), the LT8390A is going through a power-on-reset (POR), waking up the entire internal control circuitry and settling to the right initial conditions. After the POR, the LT8390A is ready and waiting for the signals on the CTRL and LOADEN pins to start switching.



## OPERATION

### Start-Up and Fault Protection

Figure 8 shows the start-up and fault sequence for the LT8390A. During the POR state, the SS pin is hard pulled down with a 100Ω to ground. In a pre-biased condition, the SS pin has to be pulled below 0.2V to enter the INIT state, where the LT8390A wait 10μs so that the SS pin can be fully discharged to ground. After the 10μs, the LT8390A enters the UP/PRE state when the LOADON signal goes high. The LOADON high signal happens when CTRL pin is above its rising latch-off thresholds (0.325V typical) and the LOADEN is high.

During the UP/PRE state, the SS pin is charged up by a 12.5μA pull-up current while the switching is disabled and the LOADTG is turned off. Once the SS pin is charged

above 0.25V, the LT8390A enters the UP/TRY state, where the LOADTG is turned on first while the switching is still disabled. If an excessive current flowing through the current sense resistor triggers the ISP/ISN over current (ISOC) signal, it will reset the LT8390A back into the POR state. After 10μs in the UP/TRY state without triggering the ISOC signal, the LT8390A enters the UP/RUN state.

During the UP/RUN state, the switching is enabled and the start-up of the output voltage  $V_{OUT}$  is controlled by the voltage on the SS pin. When the SS pin voltage is less than 1V, the LT8390A regulates the FB pin voltage to the SS pin voltage instead of the 1V reference. This allows the SS pin to be used to program soft-start by connecting an external capacitor from the SS pin to GND. The internal 12.5μA pull-up current charges up the capacitor, creating a voltage ramp on the SS pin. As the SS pin voltage rises linearly from 0.25V to 1V (and beyond), the output voltage  $V_{OUT}$  rises smoothly to its final regulation voltage.

Once the SS pin is charged above 1.75V, the LT8390A enters the OK/RUN state, where the output short detection is activated. The output short means  $V_{FB} < 0.25V$ . When the output short happens, the LT8390A enters the FAULT/RUN state, where a 1.25μA pull-down current slowly discharges the SS pin with the other conditions the same as the OK/RUN state. Once the SS pin is discharged below 1.7V, the LT8390A enters the DOWN/STOP state, where the switching is disabled and the short detection is deactivated with the previous fault latched. Once the SS pin is discharged below 0.2V and the LOADON signal is still high, the LT8390A goes back to the UP/RUN state.

In an output short condition, the LT8390A can be set to hiccup, latch-off, or keep-running fault protection mode with a resistor between the SS and  $V_{REF}$  pins. Without any resistor, the LT8390A will hiccup between 0.2V and 1.75V and go around the UP/RUN, OK/RUN, FAULT/RUN, and DOWN/STOP states until the fault condition is cleared. With a 499kΩ resistor, the LT8390A will latch off until the EN/UVLO is toggled. With a 100kΩ resistor, the LT8390A will keep running regardless of the fault.

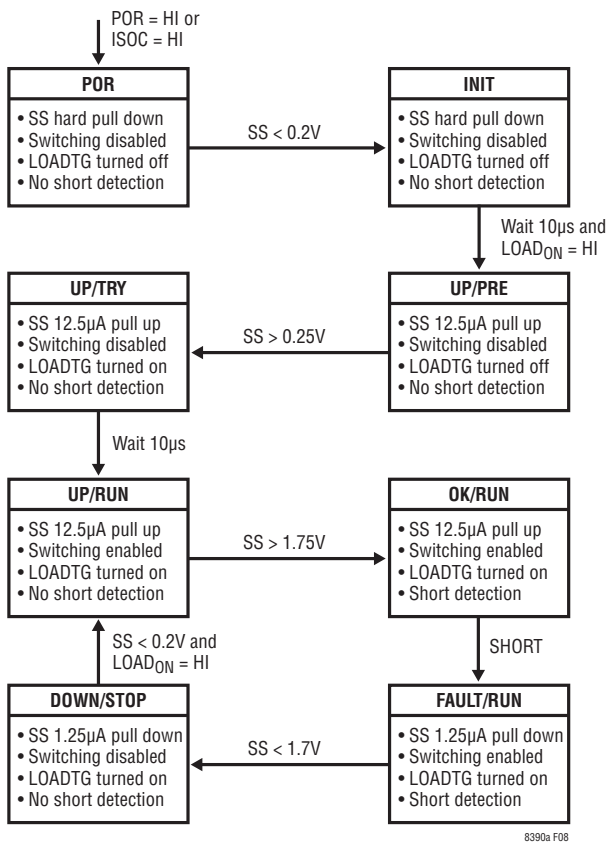

Figure 8. Start-Up and Fault Sequence



## APPLICATIONS INFORMATION

The front page shows a typical LT8390A application circuit. This Applications Information section serves as a guideline of selecting external components for typical applications. The examples and equations in this section assume continuous conduction mode unless otherwise specified.

### Switching Frequency Selection

The LT8390A uses a constant frequency control scheme between 600kHz and 2MHz. Selection of the switching frequency is a tradeoff between efficiency and component size. Low frequency operation improves efficiency by reducing MOSFET switching losses, but requires larger inductor and capacitor values. For high power applications, consider operating at lower frequencies to minimize MOSFET heating from switching losses. For low power applications, consider operating at higher frequencies to minimize the total solution size.

In addition, the specific application also plays an important role in switching frequency selection. In a noise-sensitive system, the switching frequency is usually selected to keep the switching noise out of a sensitive frequency band.

### Switching Frequency Setting

The switching frequency of the LT8390A can be set by the internal oscillator. With the SYNC/SPRD pin pulled to ground, the switching frequency is set by a resistor from the RT pin to ground. Table 1 shows  $R_T$  resistor values for common switching frequencies.

**Table 1. Switching Frequency vs  $R_T$  Value (1% Resistor)**

$f_{osc}$ (MHz)	$R_T$ (k)
0.6	267
0.8	191
1.0	147
1.2	118
1.4	97.6
1.6	82.5
1.8	66.5
2.0	59.0

### Spread Spectrum Frequency Modulation

Switching regulators can be particularly troublesome for applications where electromagnetic interference (EMI) is a concern. To improve the EMI performance, the LT8390A

implements a triangle spread spectrum frequency modulation scheme. With the SYNC/SPRD pin tied to  $INTV_{CC}$ , the LT8390A starts to spread its switching frequency 25% above the internal oscillator frequency. Figure 9 and Figure 10 show the noise spectrum of the front page application when spread spectrum enabled.

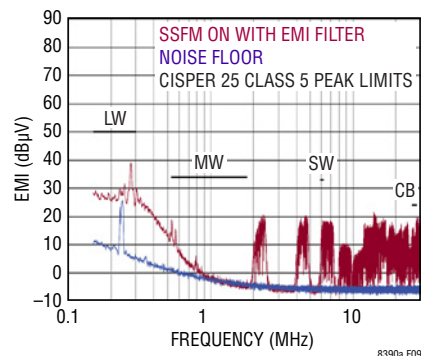

**Figure 9. Average Conducted EMI**

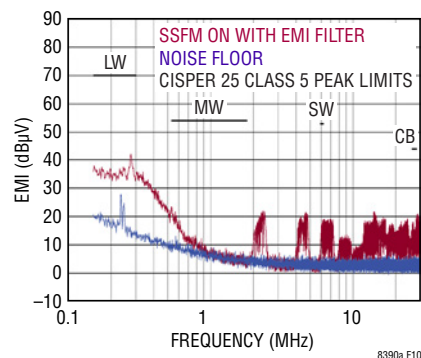

**Figure 10. Peak Conducted EMI**

### Frequency Synchronization

The LT8390A switching frequency can be synchronized to an external clock using the SYNC/SPRD pin. Driving the SYNC/SPRD with a 50% duty cycle waveform is always a good choice, otherwise maintain the duty cycle between 10% and 90%. Due to the use of a phase-locked loop (PLL) inside, there is no restriction between the synchronization frequency and the internal oscillator frequency. The rising edge of the synchronization clock represents the beginning of a switching cycle, turning on switches A and C, or switches A and D.

## APPLICATIONS INFORMATION

### Inductor Selection

The switching frequency and inductor selection are inter-related in that higher switching frequencies allow the use of smaller inductor and capacitor values. The inductor value has a direct effect on ripple current. The highest current ripple  $\Delta I_L$  % happens in the buck region at  $V_{IN(MAX)}$ , and the lowest current ripple  $\Delta I_L$  % happens in the boost region at  $V_{IN(MIN)}$ . For any given ripple allowance set by customers, the minimum inductance can be calculated as:

$$L_{BUCK} > \frac{V_{OUT} \cdot (V_{IN(MAX)} - V_{OUT})}{f \cdot I_{OUT(MAX)} \cdot \Delta I_L \% \cdot V_{IN(MAX)}}$$

$$L_{BOOST} > \frac{V_{IN(MIN)}^2 \cdot (V_{OUT} - V_{IN(MIN)})}{f \cdot I_{OUT(MAX)} \cdot \Delta I_L \% \cdot V_{OUT}^2}$$

where:

$$\Delta I_L \% = \frac{\Delta I_L}{I_{L(AVG)}}$$

f is switching frequency

$V_{IN(MIN)}$  is minimum input voltage

$V_{IN(MAX)}$  is maximum input voltage

$V_{OUT}$  is output voltage

$I_{OUT(MAX)}$  is maximum output current

Slope compensation provides stability in constant frequency current mode control by preventing subharmonic oscillations at certain duty cycles. The minimum inductance required for stability when duty cycles are larger than 50% can be calculated as:

$$L > \frac{10 \cdot V_{OUT} \cdot R_{SENSE}}{f}$$

For high efficiency, choose an inductor with low core loss, such as ferrite. Also, the inductor should have low DC resistance to reduce the  $I^2R$  losses, and must be able to handle the peak inductor current without saturating. To minimize radiated noise, use a shielded inductor.

### $R_{SENSE}$ Selection and Maximum Output Current

$R_{SENSE}$  is chosen based on the required output current. The duty cycle independent maximum current sense thresholds (50mV in peak-buck and 50mV in peak-boost) set the maximum inductor peak current in buck region, buck-boost region, and boost region.

In boost region, the lowest maximum average load current happens at  $V_{IN(MIN)}$  and can be calculated as:

$$I_{OUT(MAX\_BOOST)} = \left( \frac{50mV}{R_{SENSE}} - \frac{\Delta I_{L(BOOST)}}{2} \right) \cdot \frac{V_{IN(MIN)}}{V_{OUT}}$$

where  $\Delta I_{L(BOOST)}$  is peak-to-peak inductor ripple current in boost region and can be calculated as:

$$\Delta I_{L(BOOST)} = \frac{V_{IN(MIN)} \cdot (V_{OUT} - V_{IN(MIN)})}{f \cdot L \cdot V_{OUT}}$$

In buck region, the lowest maximum average load current happens at  $V_{IN(MAX)}$  and can be calculated as:

$$I_{OUT(MAX\_BUCK)} = \left( \frac{50mV}{R_{SENSE}} - \frac{\Delta I_{L(BUCK)}}{2} \right)$$

where  $\Delta I_{L(BUCK)}$  is peak-to-peak inductor ripple current in buck region and can be calculated as:

$$\Delta I_{L(BUCK)} = \frac{V_{OUT} \cdot (V_{IN(MAX)} - V_{OUT})}{f \cdot L \cdot V_{IN(MAX)}}$$

The maximum current sense  $R_{SENSE}$  in boost region is:

$$R_{SENSE(BOOST)} = \frac{2 \cdot 50mV \cdot V_{IN(MIN)}}{2 \cdot I_{OUT(MAX)} \cdot V_{OUT} + \Delta I_{L(BOOST)} \cdot V_{IN(MIN)}}$$

The maximum current sense  $R_{SENSE}$  in buck region is

$$R_{SENSE(BUCK)} = \frac{2 \cdot 50mV}{2 \cdot I_{OUT(MAX)} + \Delta I_{L(BUCK)}}$$

The final  $R_{SENSE}$  value should be lower than the calculated  $R_{SENSE}$  in both buck and boost regions. A 20% to 30% margin is usually recommended. Always choose a low ESL current sense resistor.

## APPLICATIONS INFORMATION

### Power MOSFET Selection

The LT8390A requires four external N-channel power MOSFETs, two for the top switches (switches A and D shown in Figure 1) and two for the bottom switches (switches B and C shown in Figure 1). Important parameters for the power MOSFETs are the breakdown voltage  $V_{BR(DSS)}$ , threshold voltage  $V_{GS(TH)}$ , on-resistance  $R_{DS(ON)}$ , reverse transfer capacitance  $C_{RSS}$  and maximum current  $I_{DS(MAX)}$ .

To achieve 2MHz operation, the power MOSFET selection is critical. With typical 25ns shoot-through protection deadtime, high performance power MOSFETs with low  $Q_g$  and low  $R_{DS(ON)}$  must be used.

Since the gate drive voltage is set by the 5V  $INTV_{CC}$  supply, logic-level threshold MOSFETs must be used in LT8390A applications. Switching four MOSFETs at higher frequency like 2MHz, the substantial gate charge current from  $INTV_{CC}$  can be estimated as:

$$I_{INTVCC} = f \cdot (Q_{gA} + Q_{gB} + Q_{gC} + Q_{gD})$$

where:

$f$  is the switching frequency

$Q_{gA}, Q_{gB}, Q_{gC}, Q_{gD}$  are the total gate charges of MOSFETs A, B, C, D

Make sure the total required  $INTV_{CC}$  current not exceeding the  $INTV_{CC}$  current limit in the datasheet. Typically, MOSFETs with less than 10nC  $Q_g$  are recommended.

The LT8390A uses the  $V_{IN}/V_{OUT}$  ratio to transition between modes and regions. Bigger IR drop in the power path caused by improper MOSFET and inductor selection may prevent the LT8390A from smooth transition. To ensure smooth transitions between buck, buck-boost, and boost modes of operation, choose low  $R_{DS(ON)}$  MOSFETs and low DCR inductor to satisfy:

$$I_{OUT(MAX)} \leq \frac{0.025 \cdot V_{OUT}}{R_{A,B} + R_{C,D} + R_{SENSE} + R_L}$$

where:

$R_{A,B}$  is the maximum  $R_{DS(ON)}$  of MOSFETs A or B at 25°C

$R_{C,D}$  is the maximum  $R_{DS(ON)}$  of MOSFETs C or D at 25°C

$R_L$  is the maximum DCR resistor of inductor at 25°C

The  $R_{DS(ON)}$  and DCR increase at higher junction temperatures and the process variation have been included in the calculation above.

In order to select the power MOSFETs, the power dissipated by the device must be known. For switch A, the maximum power dissipation happens in boost region, when it remains on all the time. Its maximum power dissipation at maximum output current is given by:

$$P_{A(BOOST)} = \left( \frac{I_{OUT(MAX)} \cdot V_{OUT}}{V_{IN}} \right)^2 \cdot \rho_T \cdot R_{DS(ON)}$$

where  $\rho_T$  is a normalization factor (unity at 25°C) accounting for the significant variation in on-resistance with temperature, typically 0.4%/°C as shown in Figure 11. For a maximum junction temperature of 125°C, using a value of  $\rho_T = 1.5$  is reasonable.

Switch B operates in buck region as the synchronous rectifier. Its power dissipation at maximum output current is given by:

$$P_{B(BUCK)} = \frac{V_{IN} - V_{OUT}}{V_{IN}} \cdot I_{OUT(MAX)}^2 \cdot \rho_T \cdot R_{DS(ON)}$$

Switch C operates in boost region as the control switch. Its power dissipation at maximum current is given by:

$$P_{C(BOOST)} = \frac{(V_{OUT} - V_{IN}) \cdot V_{OUT}}{V_{IN}^2} \cdot I_{OUT(MAX)}^2 \cdot \rho_T \cdot R_{DS(ON)} + k \cdot V_{OUT}^3 \cdot \frac{I_{OUT(MAX)}}{V_{IN}} \cdot C_{RSS} \cdot f$$

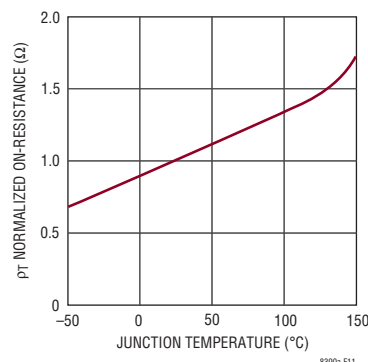

Figure 11. Normalized  $R_{DS(ON)}$  vs Temperature

8390afa

## APPLICATIONS INFORMATION

where  $C_{RSS}$  is usually specified by the MOSFET manufacturers. The constant  $k$ , which accounts for the loss caused by reverse recovery current, is inversely proportional to the gate drive current and has an empirical value of 1.7.

For switch D, the maximum power dissipation happens in boost region, when its duty cycle is higher than 50%. Its maximum power dissipation at maximum output current is given by:

$$P_{D(BOOST)} = \frac{V_{OUT}}{V_{IN}} \cdot I_{OUT(MAX)}^2 \cdot \rho_T \cdot R_{DS(ON)}$$

For the same output voltage and current, switch A has the highest power dissipation and switch B has the lowest power dissipation unless a short occurs at the output.

From a known power dissipated in the power MOSFET, its junction temperature can be obtained using the following formula:

$$T_J = T_A + P \cdot R_{TH(JA)}$$

The junction-to-ambient thermal resistance  $R_{TH(JA)}$  includes the junction-to-case thermal resistance  $R_{TH(JC)}$  and the case-to-ambient thermal resistance  $R_{TH(CA)}$ . This value of  $T_J$  can then be compared to the original, assumed value used in the iterative calculation process.

### Optional Schottky Diode ( $D_B$ , $D_D$ ) Selection

The optional Schottky diodes  $D_B$  (in parallel with switch B) and  $D_D$  (in parallel with switch D) conduct during the dead time between the conduction of the power MOSFET switches. They are intended to prevent the body diode of synchronous switches B and D from turning on and storing charge during the dead time. In particular,  $D_B$  significantly reduces reverse recovery current between switch B turn-off and switch A turn-on, and  $D_D$  significantly reduces reverse recovery current between switch D turn-off and switch C turn-on. They improve converter efficiency and reduce switch voltage stress. In order for the diode to be effective, the inductance between it and the synchronous switch must be as small as possible, mandating that these components be placed adjacently.

### $C_{IN}$ and $C_{OUT}$ Selection

Input and output capacitance is necessary to suppress voltage ripple caused by discontinuous current moving in and out the regulator. A parallel combination of capacitors is typically used to achieve high capacitance and low equivalent series resistance (ESR). Dry tantalum, special polymer, aluminum electrolytic and ceramic capacitors are all available in surface mount packages. Capacitors with low ESR and high ripple current ratings, such as OS-CON and POSCAP are also available.

Ceramic capacitors should be placed near the regulator input and output to suppress high frequency switching spikes. Ceramic capacitors, of at least  $1\mu F$ , should also be placed from  $V_{IN}$  to GND and  $V_{OUT}$  to GND as close to the LT8390A pins as possible. Due to their excellent low ESR characteristics, ceramic capacitors can significantly reduce input ripple voltage and help reduce power loss in the higher ESR bulk capacitors. X5R or X7R dielectrics are preferred, as these materials retain their capacitance over wide voltage and temperature ranges. Many ceramic capacitors, particularly 0805 or 0603 case sizes, have greatly reduced capacitance at the desired operating voltage.

**Input Capacitance  $C_{IN}$ :** Discontinuous input current is highest in the buck region due to the switch A toggling on and off. Make sure that the  $C_{IN}$  capacitor network has low enough ESR and is sized to handle the maximum RMS current. In buck region, the input RMS current is given by:

$$I_{RMS} \approx I_{OUT(MAX)} \cdot \frac{V_{OUT}}{V_{IN}} \cdot \sqrt{\frac{V_{IN}}{V_{OUT}} - 1}$$

The formula has a maximum at  $V_{IN} = 2V_{OUT}$ , where  $I_{RMS} = I_{OUT(MAX)}/2$ . This simple worst-case condition is commonly used for design because even significant deviations do not offer much relief.

**Output Capacitance  $C_{OUT}$ :** Discontinuous current shifts from the input to the output in the boost region. Make sure that the  $C_{OUT}$  capacitor network is capable of reducing the output voltage ripple. The effects of ESR and the bulk capacitance must be considered when choosing the right capacitor for a given output ripple voltage. The maximum steady state ripple due to charging and discharging the bulk capacitance is given by:

## APPLICATIONS INFORMATION

$$\Delta V_{\text{CAP(BOOST)}} = \frac{I_{\text{OUT(MAX)}} \cdot (V_{\text{OUT}} - V_{\text{IN(MIN)}})}{C_{\text{OUT}} \cdot V_{\text{OUT}} \cdot f}$$

$$\Delta V_{\text{CAP(BUCK)}} = \frac{V_{\text{OUT}} \cdot \left(1 - \frac{V_{\text{OUT}}}{V_{\text{IN(MAX)}}}\right)}{8 \cdot L \cdot f^2 \cdot C_{\text{OUT}}}$$

The maximum steady ripple due to the voltage drop across the ESR is given by:

$$\Delta V_{\text{ESR(BOOST)}} = \frac{V_{\text{OUT}} \cdot I_{\text{OUT(MAX)}}}{V_{\text{IN(MIN)}}} \cdot \text{ESR}$$

$$\Delta V_{\text{ESR(BUCK)}} = \frac{V_{\text{OUT}} \cdot \left(1 - \frac{V_{\text{OUT}}}{V_{\text{IN(MAX)}}}\right)}{L \cdot f} \cdot \text{ESR}$$

### INTV<sub>CC</sub> Regulator

An internal P-channel low dropout regulator produces 5V at the INTV<sub>CC</sub> pin from the V<sub>IN</sub> supply pin. The INTV<sub>CC</sub> powers internal circuitry and gate drivers in the LT8390A. The INTV<sub>CC</sub> regulator can supply a peak current of 145mA and must be bypassed to ground with a minimum of 4.7μF ceramic capacitor. Good local bypass is necessary to supply the high transient current required by MOSFET gate drivers.

Higher input voltage applications with large MOSFETs being driven at higher switching frequencies may cause the maximum junction temperature rating for the LT8390A to be exceeded. The system supply current is normally dominated by the gate charge current. Additional external loading of the INTV<sub>CC</sub> also needs to be taken into account for the power dissipation calculation. The total LT8390A power dissipation in this case is V<sub>IN</sub> • I<sub>INTVCC</sub>, and overall efficiency is lowered. The junction temperature can be estimated by using the equation:

$$T_J = T_A + P_D \cdot \theta_{JA}$$

where θ<sub>JA</sub> (in °C/W) is the package thermal resistance.

To prevent maximum junction temperature from being exceeded, the input supply current must be checked operating in continuous mode at maximum V<sub>IN</sub>.

### Top Gate MOSFET Driver Supply (C<sub>BST1</sub>, C<sub>BST2</sub>)

The top MOSFET drivers, TG1 and TG2, are driven between their respective SW and BST pin voltages. The boost voltages are biased from floating bootstrap capacitors C<sub>BST1</sub> and C<sub>BST2</sub>, which are normally recharged through both the external and internal bootstrap diodes when the respective top MOSFET is turned off. External bootstrap diodes are recommended because the internal bootstrap diodes are not always strong enough to refresh top MOSFETs at 2MHz. Both capacitors are charged to the same voltage as the INTV<sub>CC</sub> voltage. The bootstrap capacitors C<sub>BST1</sub> and C<sub>BST2</sub>, need to store about 100 times the gate charge required by the top switches A and D. In most applications, a 0.1μF to 0.47μF, X5R or X7R dielectric capacitor is adequate.

### Programming V<sub>IN</sub> UVLO

A resistor divider from V<sub>IN</sub> to the EN/UVLO pin implements V<sub>IN</sub> undervoltage lockout (UVLO). The EN/UVLO enable falling threshold is set at 1.220V with 13mV hysteresis. In addition, the EN/UVLO pin sinks 2.5μA when the voltage on the pin is below 1.220V. This current provides user programmable hysteresis based on the value of R1. The programmable UVLO thresholds are:

$$V_{\text{IN(UVLO+)}} = 1.233\text{V} \cdot \frac{R1+R2}{R2} + 2.5\mu\text{A} \cdot R1$$

$$V_{\text{IN(UVLO-)}} = 1.220\text{V} \cdot \frac{R1+R2}{R2}$$

Figure 12 shows the implementation of external shut-down control while still using the UVLO function. The NMOS grounds the EN/UVLO pin when turned on, and puts the LT8390A in shutdown with quiescent current less than 2μA.

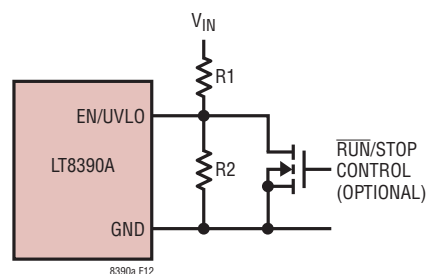

Figure 12. V<sub>IN</sub> Undervoltage Lockout (UVLO)



## APPLICATIONS INFORMATION

### Programming Input or Output Current Limit

The input or output current limit can be programmed by placing an appropriate value current sense resistor,  $R_{IS}$ , in the input or output power path. The voltage drop across  $R_{IS}$  is (Kelvin) sensed by the ISP and ISN pins. The CTRL pin should be tied to a voltage higher than 1.35V to get the full-scale 100mV (typical) threshold across the sense resistor. The CTRL pin can be used to reduce the current threshold to zero, although relative accuracy decreases with the decreasing sense threshold. When the CTRL pin voltage is between 0.3V and 1.15V, the current limit is:

$$I_{IS(MAX)} = \frac{V_{CTRL} - 0.25V}{10 \cdot R_{IS}}$$

When  $V_{CTRL}$  is between 1.15V and 1.35V the current limit varies with  $V_{CTRL}$ , but departs from the equation above by an increasing amount as  $V_{CTRL}$  increases. Ultimately, when  $V_{CTRL}$  is larger than 1.35V, the current limit no longer varies. The typical  $V_{(ISP-ISN)}$  threshold vs  $V_{CTRL}$  is listed in Table 2.

**Table 2.  $V_{(ISP-ISN)}$  Threshold vs  $V_{CTRL}$**

$V_{CTRL}$ (V)	$V_{(ISP-ISN)}$ (mV)
1.15	90
1.20	94.5
1.25	98
1.30	99.5
1.35	100

When  $V_{CTRL}$  is larger than 1.35V, the current threshold is regulated to:

$$I_{IS(MAX)} = \frac{100mV}{R_{IS}}$$

The CTRL pin should not be left open (tie to  $V_{REF}$  if not used). The CTRL pin can also be used in conjunction with a thermistor to provide overtemperature protection for the output load, or with a resistor divider to  $V_{IN}$  to reduce output power and switching current when  $V_{IN}$  is low.

The presence of a time varying differential voltage ripple signal across the ISP and ISN pins at the switching

frequency is expected. If the current sense resistor  $R_{IS}$  is placed between power input and input bulk capacitor (Figure 13a), or between output bulk capacitor and system output (Figure 14a), a filter is typically not necessary. If the  $R_{IS}$  is placed between input bulk capacitor and input decoupling capacitor (Figure 13b), or between output decoupling capacitor and output bulk capacitor (Figure 14b), a low pass filter formed by  $R_F$  and  $C_F$  is recommended to reduce the current ripple and stabilize the current loop. Since the bias currents of the ISP and ISN pins are matched, no offset is introduced by  $R_F$ . If input or output current limit is not used, the ISP and ISN pins should be shorted to  $V_{IN}$ ,  $V_{OUT}$ , or ground.

### ISMON Current Monitor

The ISMON pin provides a buffered monitor output of the current flowing through the ISP/ISN current sense resistor,  $R_{IS}$ . The  $V_{ISMON}$  voltage is calculated as  $V_{(ISP-ISN)} \cdot 10 + 0.25V$ . Since the ISMON pin has the same 0.25V offset as the CTRL pin, the master LT8390A ISMON pin can be directly tied to the slave LT8390A CTRL pin for equal current sharing in parallel applications.

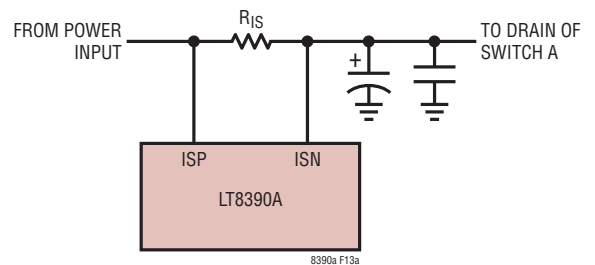

(13a)

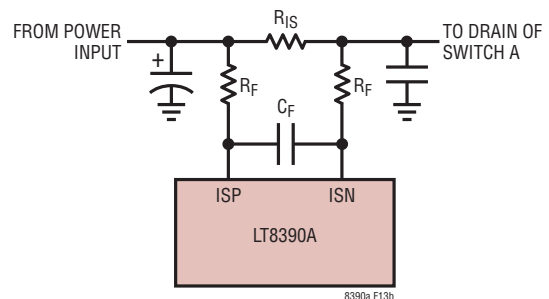

(13b)

**Figure 13. Programming Input Current Limit**

## APPLICATIONS INFORMATION

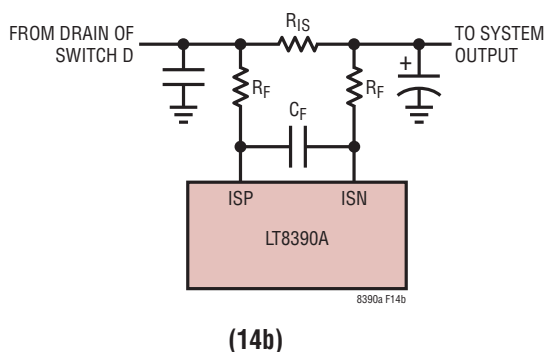
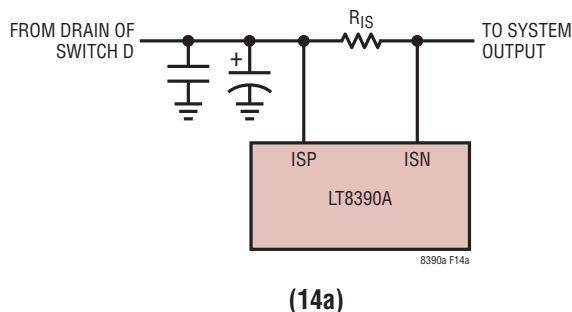

Figure 14. Programming Output Current Limit

### Load Switch Control

The LOADEN and LOADTG pins provide high side PMOS load switch control. The LOADEN pin accepts a logic level ON/OFF signal and then drives the LOADTG pin to turn on or off the high side PMOS load switch, thereby connecting or disconnecting the LT8390A power output from the system output. When the LOADEN pin is forced low, the LT8390A turns off TG1 and TG2, turns on BG1 and BG2, disconnects the V<sub>C</sub> pin from all internal loads, and turns off LOADTG. The LOADEN pin should not be left open (tie to INTV<sub>CC</sub> or V<sub>REF</sub> if not used).

### High Side PMOS Load Switch Selection

A high side PMOS load switch is recommended in some LT8390A applications requiring load switch control. The high side PMOS load switch is typically selected for drain-source voltage V<sub>DS</sub>, gate-source threshold voltage V<sub>GS(TH)</sub>, and continuous drain current I<sub>D</sub>. For proper operations, V<sub>DS</sub> rating should exceed the output regulation voltage set by the FB pin, the absolute value of V<sub>GS(TH)</sub> should be less than 3V, and I<sub>D</sub> rating should be above I<sub>OUT(MAX)</sub>.

### Programming Output Voltage and Thresholds

The LT8390A has a voltage feedback pin FB that can be used to program a constant-voltage output. The output voltage can be set by selecting the values of R3 and R4 (Figure 15) according to the following equation:

$$V_{OUT} = 1V \cdot \frac{R3+R4}{R4}$$

In addition, the FB pin also sets output overvoltage threshold, output power good thresholds, and output short threshold. For an application with small output capacitors, the output voltage may overshoot a lot during

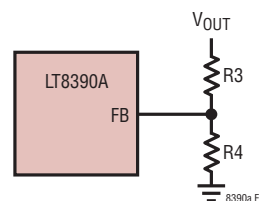

Figure 15. Feedback Resistor Connection

load transient event. Once the FB pin hits its overvoltage threshold 1.1V, the LT8390A stops switching by turning off TG1, BG1, TG2, and BG2, and also turns off LOADTG to disconnect the output load for protection. The output overvoltage threshold can be set as:

$$V_{OUT(OVP)} = 1.1V \cdot \frac{R3+R4}{R4}$$

To provide the output short-circuit detection and protection, the output short falling threshold can be set as:

$$V_{OUT(SHORT)} = 0.25V \cdot \frac{R3+R4}{R4}$$

### Power GOOD (PGOOD) Pin

The LT8390A provides an open-drain status pin, PGOOD, which is pulled low when V<sub>FB</sub> is within ±10% of the 1.00V regulation voltage. The PGOOD pin is allowed to be pulled up by an external resistor to INTV<sub>CC</sub> or an external voltage source of up to 6V.

## APPLICATIONS INFORMATION

### Soft-Start and Short-Circuit Protection

As shown in Figure 8 and explained in the Operation section, the SS pin can be used to program the output voltage soft-start by connecting an external capacitor from the SS pin to ground. The internal 12.5μA pull-up current charges up the capacitor, creating a voltage ramp on the SS pin. As the SS pin voltage rises linearly from 0.25V to 1V (and beyond), the output voltage rises smoothly into its final voltage regulation. The soft-start time can be calculated as:

$$t_{SS} = 1V \cdot \frac{C_{SS}}{12.5\mu A}$$

Make sure the  $C_{SS}$  is at least five to ten times larger than the compensation capacitor on the  $V_C$  pin for a well-controlled output voltage soft-start. A 22nF ceramic capacitor is a good starting point.

The SS pin is also used as a fault timer. Once an output short-circuit fault is detected, a 1.25μA pull-down current source is activated. Using a single resistor from the SS pin to the  $V_{REF}$  pin, the LT8390A can be set to three different fault protection modes: hiccup (no resistor), latch-off (499k), and keep-running (100k).

With a 100k resistor in keep-running mode, the LT8390A continues switching normally and regulates the current into ground. With a 499k resistor in latch-off mode, the LT8390A stops switching until the EN/UVLO pin is pulled low and high to restart. With no resistor in hiccup mode, the LT8390A enters low duty cycle auto-retry operation. The 1.25μA pull-down current discharges the SS pin to 0.2V and then 12.5μA pull-up current charges the SS pin up. If the output short-circuit condition has not been removed when the SS pin reaches 1.75V, the 1.25μA pull-down current turns on again, initiating a new hiccup cycle. This will continue until the fault is removed. Once the output short-circuit condition is removed, the output will have a smooth short-circuit recovery due to soft-start.

### Loop Compensation

The LT8390A uses an internal transconductance error amplifier, the output of which,  $V_C$ , compensates the con-

trol loop. The external inductor, output capacitor, and the compensation resistor and capacitor determine the loop stability.

The inductor and output capacitor are chosen based on performance, size and cost. The compensation resistor and capacitor on the  $V_C$  pin are set to optimize control loop response and stability. For a typical voltage regulator application, a 2.2nF compensation capacitor on the  $V_C$  pin is adequate, and a series resistor should always be used to increase the slew rate on the  $V_C$  pin to maintain tighter output voltage regulation during fast transients on the input supply of the converter.

### Efficiency Considerations

The power efficiency of a switching regulator is equal to the output power divided by the input power times 100%. It is often useful to analyze individual losses to determine what is limiting the efficiency and which change would produce the most improvement. Although all dissipative elements in circuits produce losses, four main sources account for most of the losses in LT8390A circuits:

1. DC  $I^2R$  losses. These arise from the resistances of the MOSFETs, sensing resistor, inductor and PC board traces and cause the efficiency to drop at high output currents.
2. Transition loss. This loss arises from the brief amount of time switch A or switch C spends in the saturated region during switch node transitions. It depends upon the input voltage, load current, driver strength and MOSFET capacitance, among other factors.
3.  $INTV_{CC}$  current. This is the sum of the MOSFET driver and control currents.
4.  $C_{IN}$  and  $C_{OUT}$  loss. The input capacitor has the difficult job of filtering the large RMS input current to the regulator in buck region. The output capacitor has the difficult job of filtering the large RMS output current in boost region. Both  $C_{IN}$  and  $C_{OUT}$  are required to have low ESR to minimize the AC  $I^2R$  loss and sufficient capacitance to prevent the RMS current from causing additional upstream losses in fuses or batteries.



## APPLICATIONS INFORMATION

5. Other losses. Schottky diode  $D_B$  and  $D_D$  are responsible for conduction losses during dead time and light load conduction periods. Inductor core loss occurs predominately at light loads. Switch A causes reverse recovery current loss in buck region, and switch C causes reverse recovery current loss in boost region.

When making adjustments to improve efficiency, the input current is the best indicator of changes in efficiency. If you make a change and the input current decreases, then the efficiency has increased. If there is no change in the input current, then there is no change in efficiency.

### PC Board Layout Checklist

The basic PC board layout requires a dedicated ground plane layer. Also, for high current, a multilayer board provides heat sinking for power components.

- The ground plane layer should not have any traces and it should be as close as possible to the layer with power MOSFETs.
- Place  $C_{IN}$ , switch A, switch B and  $D_B$  in one compact area. Place  $C_{OUT}$ , switch C, switch D and  $D_D$  in one compact area.
- Use immediate vias to connect the components to the ground plane. Use several large vias for each power component.
- Use planes for  $V_{IN}$  and  $V_{OUT}$  to maintain good voltage filtering and to keep power losses low.
- Flood all unused areas on all layers with copper. Flooding with copper will reduce the temperature rise of power components. Connect the copper areas to any DC net ( $V_{IN}$  or GND).
- Separate the signal and power grounds. All small-signal components should return to the exposed GND pad from the bottom, which is then tied to the power GND close to the sources of switch B and switch C.
- Place switch A and switch C as close to the controller as possible, keeping the PGND, BG and SW traces short.
- Keep the high dV/dT SW1, SW2, BST1, BST2, TG1 and TG2 nodes away from sensitive small-signal nodes.
- The path formed by switch A, switch B,  $D_B$  and the  $C_{IN}$  capacitor should have short leads and PCB trace lengths. The path formed by switch C, switch D,  $D_D$  and the  $C_{OUT}$  capacitor also should have short leads and PCB trace lengths.
- The output capacitor (–) terminals should be connected as close as possible to the (–) terminals of the input capacitor.
- Connect the top driver bootstrap capacitor  $C_{BST1}$  closely to the BST1 and SW1 pins. Connect the top driver bootstrap capacitor  $C_{BST2}$  closely to the BST2 and SW2 pins.
- Connect the input capacitors  $C_{IN}$  and output capacitors  $C_{OUT}$  closely to the power MOSFETs. These capacitors carry the MOSFET AC current.
- Route LSP and LSN traces together with minimum PCB trace spacing. Avoid sense lines pass through noisy areas, such as switch nodes. The filter capacitor between LSP and LSN should be as close as possible to the IC. Ensure accurate current sensing with Kelvin connections at the  $R_{SENSE}$  resistor. Low ESL sense resistor is recommended.
- Connect the  $V_C$  pin compensation network close to the IC, between  $V_C$  and the signal ground. The capacitor helps to filter the effects of PCB noise and output voltage ripple voltage from the compensation loop.
- Connect the  $INTV_{CC}$  bypass capacitor,  $C_{INTV_{CC}}$ , close to the IC, between the  $INTV_{CC}$  and the power ground. This capacitor carries the MOSFET drivers' current peaks.

## TYPICAL APPLICATIONS

95% Efficient 48W (12V 4A) 2MHz Buck-Boost Voltage Regulator

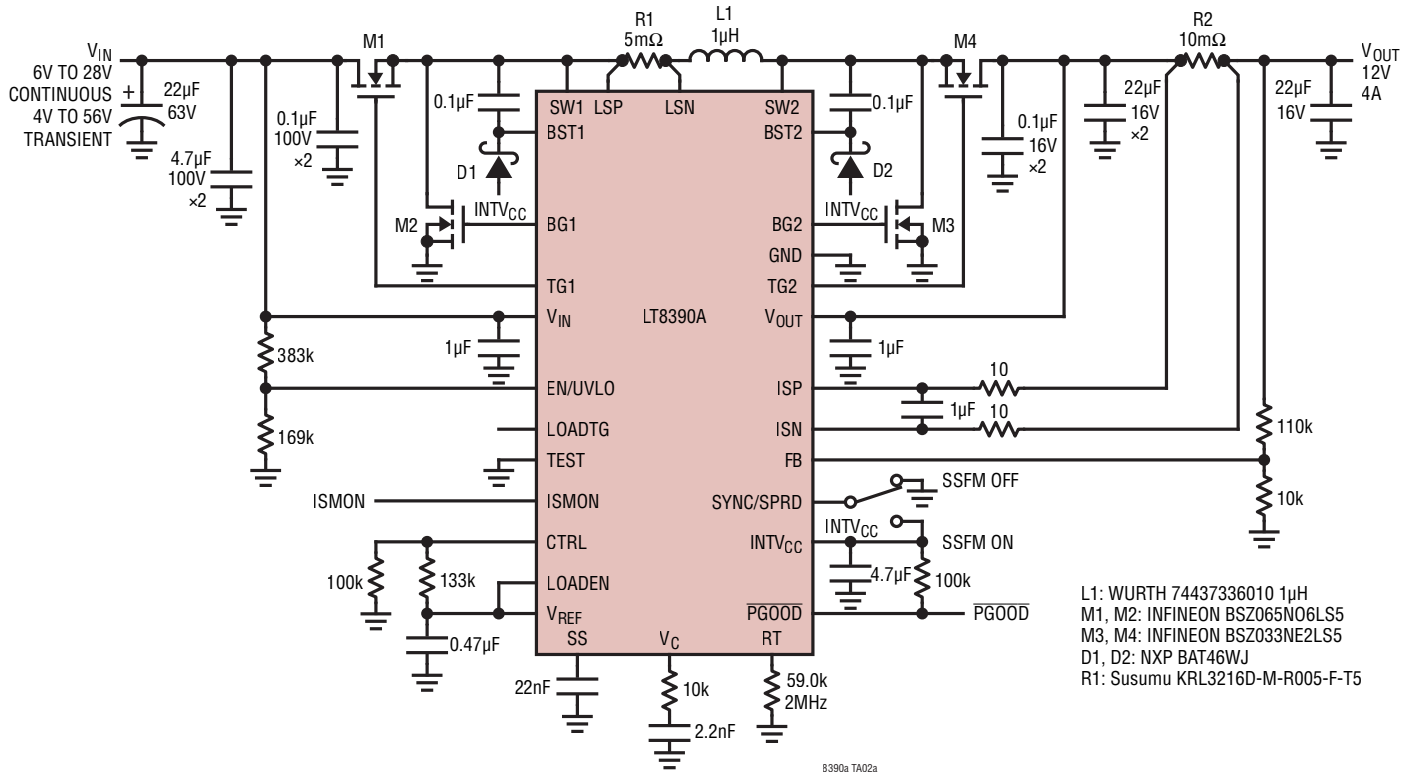

# PACKAGE DESCRIPTION

Please refer to <http://www.linear.com/product/LT8390A#packaging> for the most recent package drawings.

**FE Package**  
**28-Lead Plastic TSSOP (4.4mm)**  
 (Reference LTC DWG # 05-08-1663 Rev L)  
**Exposed Pad Variation EB**

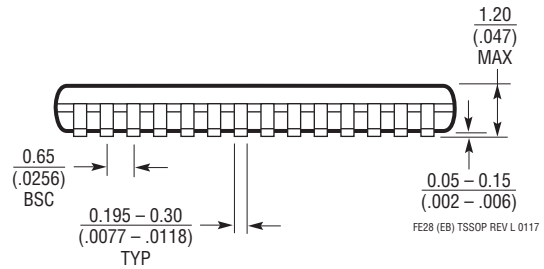
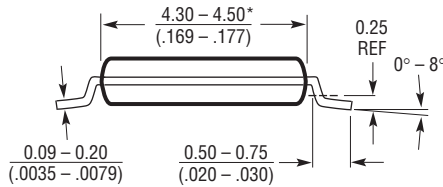
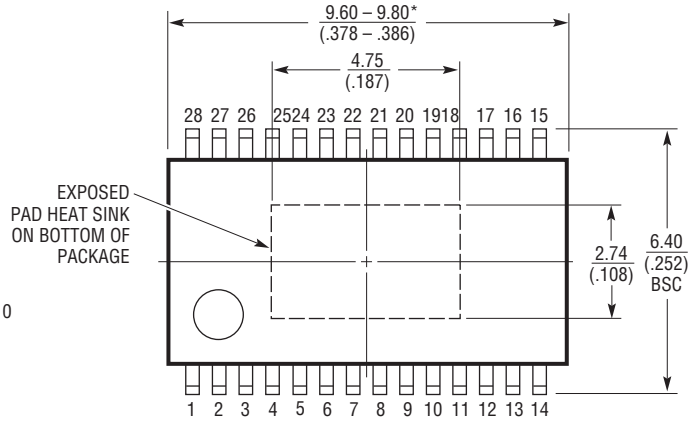
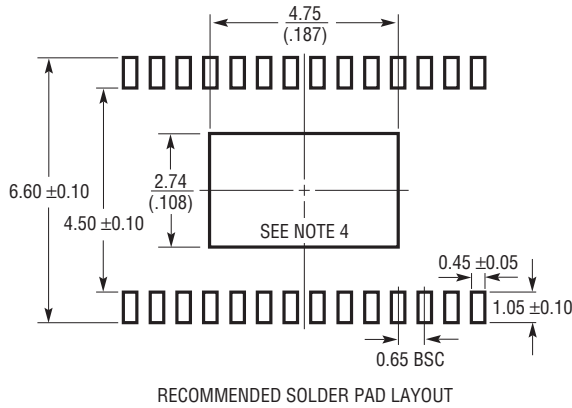

- NOTE:
1. CONTROLLING DIMENSION: MILLIMETERS
  2. DIMENSIONS ARE IN MILLIMETERS (INCHES)
  3. DRAWING NOT TO SCALE
  4. RECOMMENDED MINIMUM PCB METAL SIZE FOR EXPOSED PAD ATTACHMENT
- \*DIMENSIONS DO NOT INCLUDE MOLD FLASH. MOLD FLASH SHALL NOT EXCEED 0.150mm (.006") PER SIDE

## PACKAGE DESCRIPTION

Please refer to <http://www.linear.com/product/LT8390A#packaging> for the most recent package drawings.

**UFD Package**  
**28-Lead Plastic QFN (4mm × 5mm)**  
 (Reference LTC DWG # 05-08-1712 Rev C)

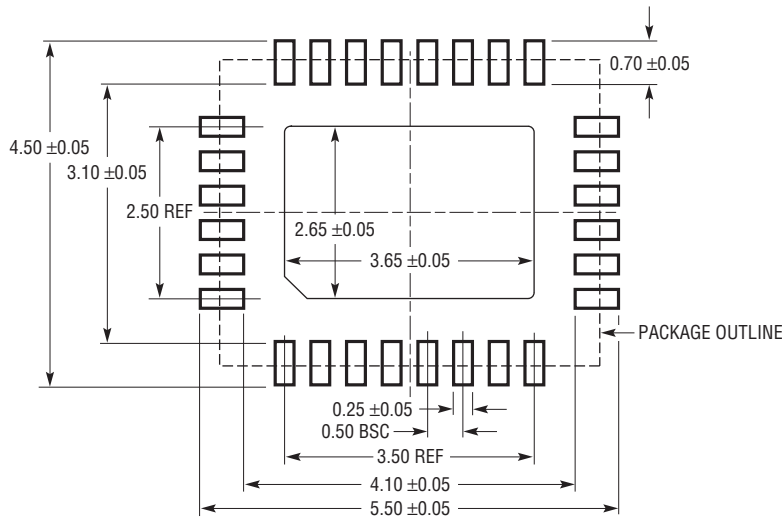

RECOMMENDED SOLDER PAD PITCH AND DIMENSIONS  
 APPLY SOLDER MASK TO AREAS THAT ARE NOT SOLDERED

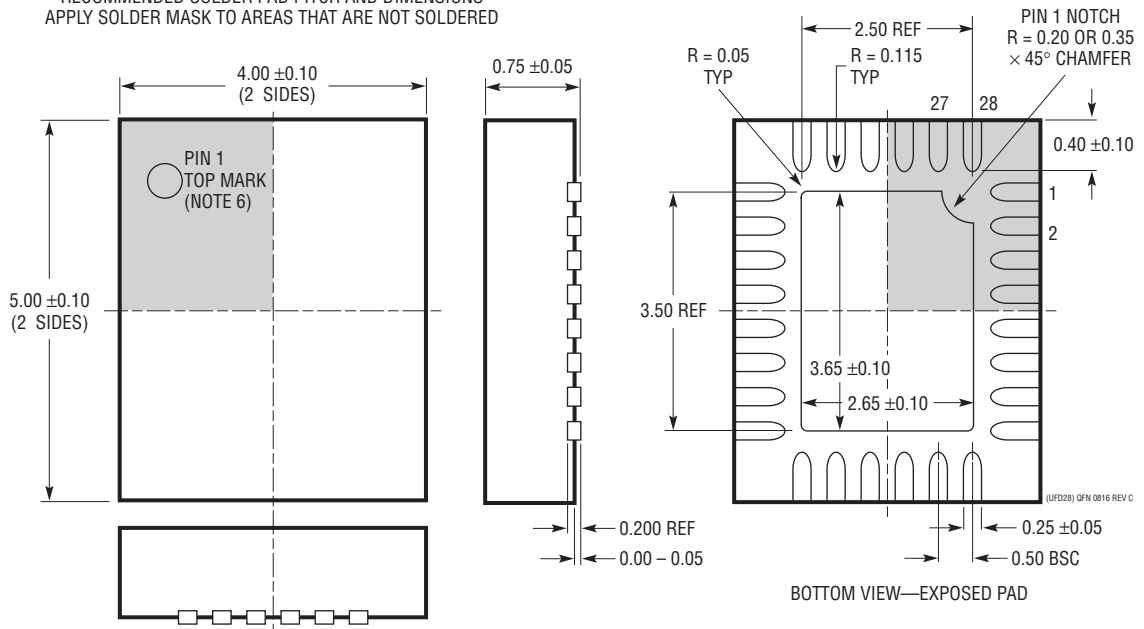

- NOTE:
1. DRAWING PROPOSED TO BE MADE A JEDEC PACKAGE OUTLINE MO-220 VARIATION (WGHD-3).
  2. DRAWING NOT TO SCALE
  3. ALL DIMENSIONS ARE IN MILLIMETERS
  4. DIMENSIONS OF EXPOSED PAD ON BOTTOM OF PACKAGE DO NOT INCLUDE MOLD FLASH. MOLD FLASH, IF PRESENT, SHALL NOT EXCEED 0.15mm ON ANY SIDE
  5. EXPOSED PAD SHALL BE SOLDER PLATED
  6. SHADED AREA IS ONLY A REFERENCE FOR PIN 1 LOCATION ON THE TOP AND BOTTOM OF PACKAGE

## REVISION HISTORY

REV	DATE	DESCRIPTION	PAGE NUMBER
A	09/17	Added H-Grade Temperature Option	2, 5
		Clarified Block Diagram	11
		Clarified Sense Resistors description in Route LSP and LSN traces bullet	25

## TYPICAL APPLICATION

### 25W (5V 5A) 2MHz Buck-Boost Voltage Regulator

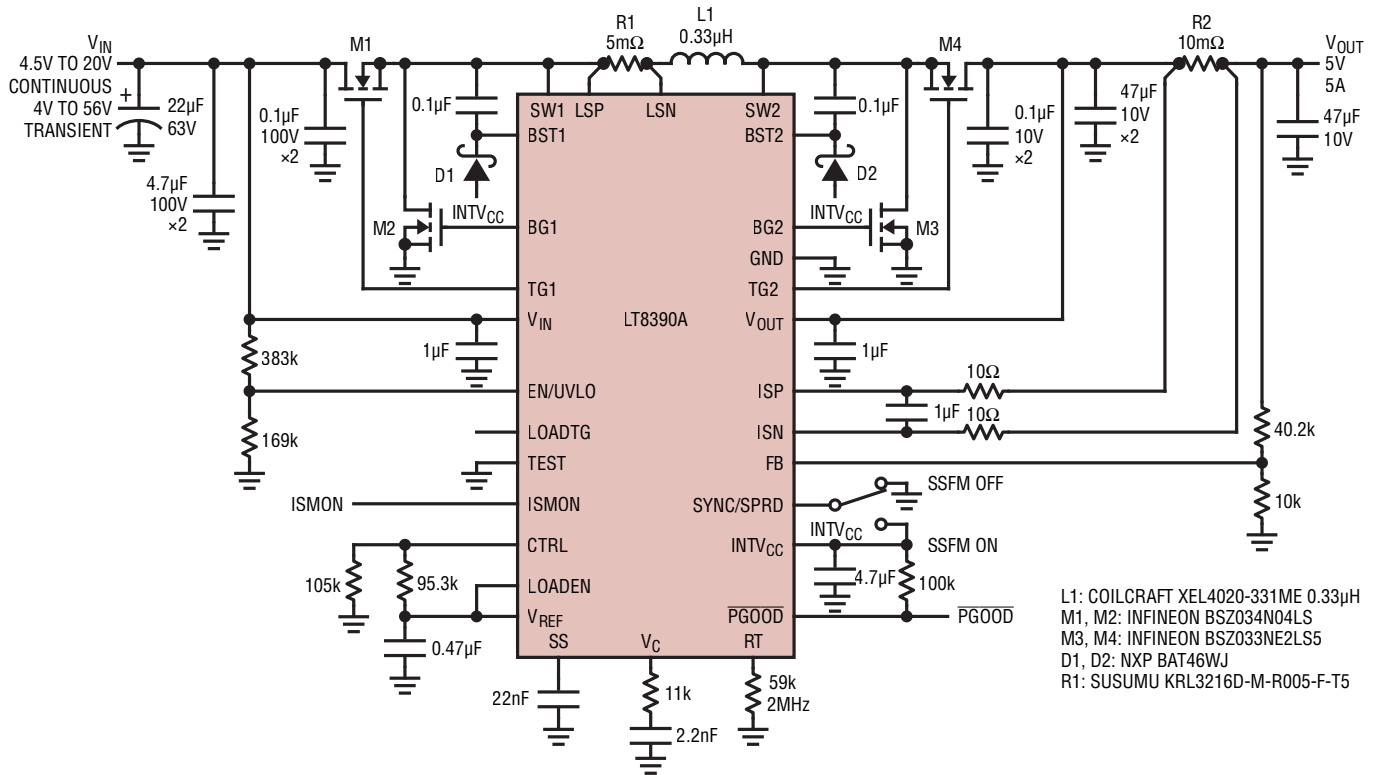

## RELATED PARTS

PART NUMBER	DESCRIPTION	COMMENTS
<a href="#">LT8390</a>	60V Synchronous 4-Switch Buck-Boost Controller with Spread Spectrum	$V_{IN}$ : 4V to 60V, $V_{OUT}$ : 0V to 60V, $\pm 1.5\%$ Voltage Accuracy, $\pm 3\%$ Current Accuracy, TSSOP-28 and 4mm $\times$ 5mm QFN-28
<a href="#">LT8391</a>	60V Synchronous 4-Switch Buck-Boost LED Controller with Spread Spectrum	$V_{IN}$ : 4V to 60V, $V_{OUT}$ : 0V to 60V, $\pm 1.5\%$ Voltage Accuracy, $\pm 3\%$ Current Accuracy, TSSOP-28 and 4mm $\times$ 5mm QFN-28
<a href="#">LT8391A</a>	60V Synchronous 2MHz 4-Switch Buck-Boost LED Controller with Spread Spectrum	$V_{IN}$ : 4V to 60V, $V_{OUT}$ : 0V to 60V, $\pm 1.5\%$ Voltage Accuracy, $\pm 3\%$ Current Accuracy, TSSOP-28 and 4mm $\times$ 5mm QFN-28
<a href="#">LT3790</a>	60V Synchronous 4-Switch Buck-Boost Controller	$V_{IN}$ : 4.7V to 60V, $V_{OUT}$ : 1.2V to 60V, Regulates $V_{OUT}$ , $I_{OUT}$ , $I_{IN}$ , TSSOP-38
<a href="#">LT8705</a>	80V $V_{IN}$ and $V_{OUT}$ Synchronous 4-Switch Buck-Boost DC/DC Controller	$V_{IN}$ : 2.8V to 80V, $V_{OUT}$ : 1.3V to 80V, Regulates $V_{OUT}$ , $I_{OUT}$ , $V_{IN}$ , $I_{IN}$ , 5mm $\times$ 7mm QFN-38 and Modified TSSOP-38 for High Voltage
<a href="#">LTC<sup>®</sup>3789</a>	High Efficiency Synchronous 4-Switch Buck-Boost Controller	$V_{IN}$ : 4V to 38V, $V_{OUT}$ : 0.8V to 38V, Regulates $V_{OUT}$ , $I_{OUT}$ or $I_{IN}$ , 5mm $\times$ 5mm QFN-32 and SSOP-24
<a href="#">LTC3780</a>	High Efficiency Synchronous 4-Switch Buck-Boost Controller	$V_{IN}$ : 4V to 36V, $V_{OUT}$ : 0.8V to 30V, Regulates $V_{OUT}$ , 4mm $\times$ 5mm QFN-28 and SSOP-28
<a href="#">LT3763</a>	60V High Current Step-Down LED Driver Controller	$V_{IN}$ : 6V to 60V, 4mm $\times$ 4mm QFN-20 and TSSOP-20
<a href="#">LT3757/LT3757A</a>	Boost, Flyback, SEPIC and Inverting Controller	$V_{IN}$ : 2.9V to 40V, Positive or Negative $V_{OUT}$ , 3mm $\times$ 3mm DFN-10, MSOP-10
<a href="#">LT3758</a>	High Input Voltage, Boost, Flyback, SEPIC and Inverting Controller	$V_{IN}$ : 5.5V to 100V, Positive or Negative $V_{OUT}$ , 3mm $\times$ 3mm DFN-10, MSOP-10
<a href="#">LT8710</a>	Synchronous SEPIC/Inverting/Boost Controller with Output Current Control	$V_{IN}$ : 4.5V to 80V, Rail-to-Rail Output Current Monitor and Control, TSSOP-28