

Evaluating the **ADP1074** Active Clamp Forward Controller

FEATURES

Fully supported evaluation kit for the **ADP1074** active clamp forward topology

12.1 V output voltage (V_{DC})

6 A steady state, 8 A peak

Programmable light load mode

Integrated driver for primary side and secondary side synchronous rectifier

External reference signal tracking

Precision enabled undervoltage lockout (UVLO) with hysteresis

Short circuit, output overvoltage, cycle by cycle input overcurrent, and over temperature protection

Frequency synchronization

Soft start and soft stop functionality

EVALUATION KIT CONTENTS

ADP1074-EVALZ evaluation board

ADDITIONAL EQUIPMENT

DC power supply capable of 36 V_{DC} to 60 V_{DC} , 3 A

Electronic load capable of 150 W, 0 V to 60 V

Oscilloscope capable of ≥ 500 MHz bandwidth, 2 channels to 4 channels

Precision digital multimeter (HP34401 or equivalent)

GENERAL DESCRIPTION

The ADP1074-EVALZ evaluation board allows users to evaluate the **ADP1074** in a power supply application.

The evaluation board can deliver a rated current of 6 A in steady state and 8 A peak that is thermally limited for an input voltage range of 36 V dc to 60 V.

Multiple test points allow easy access to all critical nodes and pins.

Full data on the **ADP1074** is available in the **ADP1074** data sheet, which should be consulted in conjunction with this user guide when using the evaluation board.

ADP1074-EVALZ EVALUATION BOARD SETUP

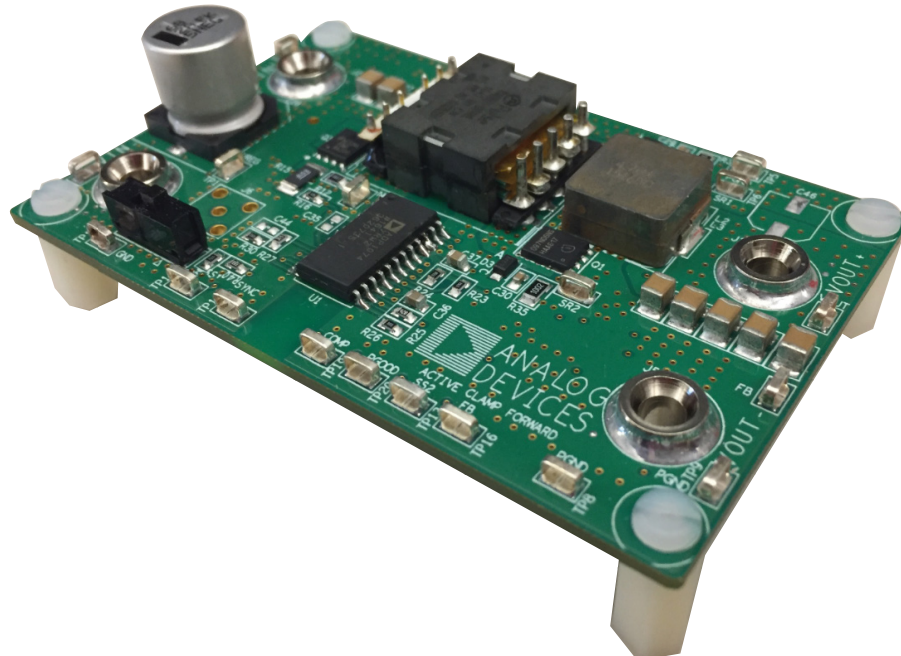

Figure 1.

TABLE OF CONTENTS

Features	1	Gate and SR pins and Functionality	5
Evaluation Kit Contents.....	1	Soft Start	5
Additional Equipment	1	Soft Stop.....	6
General Description	1	Output Ripple	6
ADP1074-EVALZ Evaluation Board Setup.....	1	Control Loop.....	7
Revision History	2	External signal tracking.....	7
Evaluation Board Overview	3	Over Current Protection	8
Power Train Overview	3	Voltage and Current Stress.....	8
Applications.....	3	SR1 and SR2 pins and phase in feature	9
Connectors	3	OCP recovery feature.....	9
Caution	3	Efficiency Curves	10
Evaluation Board Hardware.....	4	Thermal Performance.....	10
Evaluation Board Configurations	4	Evaluation Board Schematics and Artwork.....	11
Powering Up.....	4	Ordering Information.....	15
ADP1071-2-EVALZ Dimensions	4	Bill of Materials.....	15
Evaluating the ADP1074.....	5		

REVISION HISTORY

1/2018—Rev. 0 to Rev. A

Change to Figure 33	11
Change to Table 3	16

10/2017—Revision 0: Initial Version

EVALUATION BOARD OVERVIEW

This ADP1074-EVALZ evaluation board features the ADP1074 in a dc-to-dc switching power supply in an active clamp forward topology with synchronous rectification operating at 291 kHz switching frequency.

The ADP1074 circuit is designed to provide a rated load of 12.1 V_{DC} and 6 A (8 A peak) from a dc input voltage source of 36 V_{DC} to 60 V_{DC}. The ADP1074 provides features including output voltage regulation, synchronization, prebias start up, frequency synchronization, and comprehensive protection functions.

POWER TRAIN OVERVIEW

The evaluation board is shown in Figure 1. The circuit components on the ADP1074-EVALZ are described as follows:

- Q3 is an N-channel metal-oxide semiconductor field effect transistor (MOSFET) used as the main switch on the primary side of the evaluation board.
- Q4 is the active clamp reset switch on the primary side of the evaluation board.
- C31 is the clamp capacitor on the primary side of the evaluation board.
- T1 is the transformer that provides the isolation. The secondary side has an N-channel MOSFET (Q1 and Q2) as the synchronous rectifiers (SR).
- The output filter consists of an inductor (L8) and capacitor bank (C4 to C11 and C46). This is the main power stage.

Additional circuitry around the power train is described as follows. The resistor capacitor diode (RCD) snubber for the synchronous rectifiers comprises R3, C29, and D4 for Q2, and R35, C30, and D3 for Q1.

ADP1074 (U1) is the power controller that controls the power stage. It integrates gate drive for driving the primary switch and synchronous rectifier based on the Analog Devices, Inc., *iCoupler* technology. During start up, U1 is powered by the input voltage via an external start-up circuit (Q5, D5, C38, R17, and D5). Once switching starts, the T1 transformer an auxiliary windings that provides power to the VREG1 pin. R15 senses the primary current.

APPLICATIONS

High efficiency, high power density, isolated dc-to-dc power supplies include the following:

- Intermediate bus converters
- Paralleled power supply systems
- Power over Ethernet (PoE)
- Server, storage, industrial, networking, infrastructure, and so on

CONNECTORS

The connections to the ADP1074-EVALZ evaluation board are shown in Table 1.

Table 1. Evaluation Board Connections

Connector	Function
J2	VIN+, dc Input
J4	VIN-, ground return for dc input
J1	VOUT+, dc output
J5	VOUT-, return for dc output

CAUTION

This evaluation board uses high voltages. Take extreme caution, especially on the primary side, to ensure safety. It is advised to switch off the evaluation board when not in use. Use a current limited, isolated dc source at the input.

EVALUATION BOARD HARDWARE

EVALUATION BOARD CONFIGURATIONS

The evaluation board comes preconfigured with the default settings to operate the power supply at the rated load. No additional configuration is necessary other than to turn on the hardware on switch (SW1). Replace J3 with a wire if the primary current must be sensed using a current probe.

POWERING UP

1. Connect a dc source (voltage range of 36 V_{DC} to 60 V_{DC}) at the input terminals and an electronic load at the output terminals.
2. Connect voltmeters on the input terminals (TP11 and TP3) and output terminals (TP2 and TP5) separately, as needed.

3. Connect the voltage probes at different test pins. Use the differential probes and ensure the ground of the probes are isolated if the measurements are made on the primary and secondary side of the transformer (T1) simultaneously.
4. Set the electronic load to 6 A.
5. Turn the PSON switch (SW1) to the on position.

The output must read 12.1 V_{DC}.

ADP1074-EVALZ DIMENSIONS

Table 2 shows the dimensions of the ADP1074-EVALZ evaluation board. The dimensions exclude standoff.

Table 2.

Dimension	Value (Inches)
Length	2.2
Width	3.45
Height	0.59

EVALUATING THE ADP1074

Several test points on the evaluation board allow easy monitoring of the various signals. The user can program the operation according to the ADP1074 data sheet. The following sections provide descriptions of the typical features and results when evaluating the device.

GATE AND SR PINS AND FUNCTIONALITY

The gate signals NGATE, PGATE, SR1, and SR2 are generated by isolated gate drivers within the ADP1074. The logic high level is VREG1 for NGATE and PGATE pins, and VREG2 for the SR pin, while both logic low level is 0 V. An example of GATE and SR waveforms is shown in Figure 2. All the signals shown represent the signals at the output pins of the integrated circuit (IC).

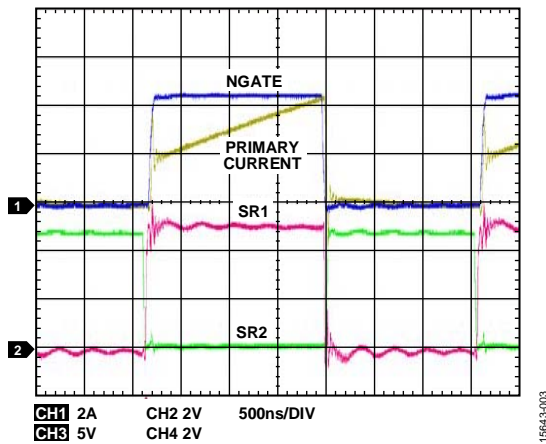

Figure 2. Pulse-Width Modulations (PWMs) at Steady State Load

Switching Frequency, Duty Cycle Limit, and Frequency Synchronization

The internal oscillator frequency can be programmed by setting the R27 and R30 resistors at the RT and DMAX pins of the ADP1074, respectively. The evaluation board is setup for a nominal specification of 291 kHz. Use the DMAX pin to program a maximum duty cycle. Refer to the data sheet for additional details.

PWM Jitter

Figure 3 shows the typical NGATE PWM jitter at a nominal input voltage of 48 V and a load of 6 A.

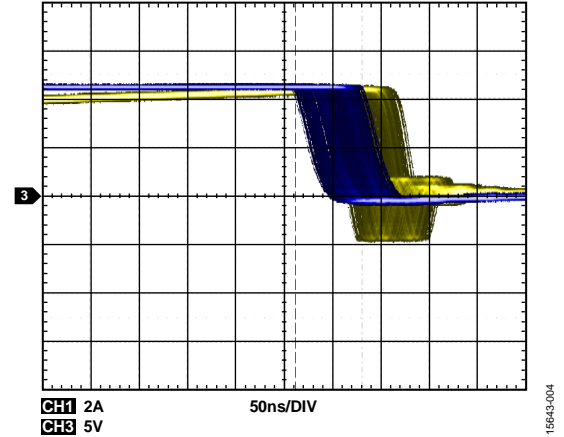

Figure 3. NGATE PWM Jitter at 48 V DC Input, 6 A Load

SOFT START

Once the voltage at the EN pin exceeds the enable threshold, the converter enters a two-stage soft start sequence, allowing the output voltage to ramp up smoothly. For details, please refer to the ADP1074 data sheet. Figure 4 and Figure 5 show the soft start under a no load and a heavy load condition.

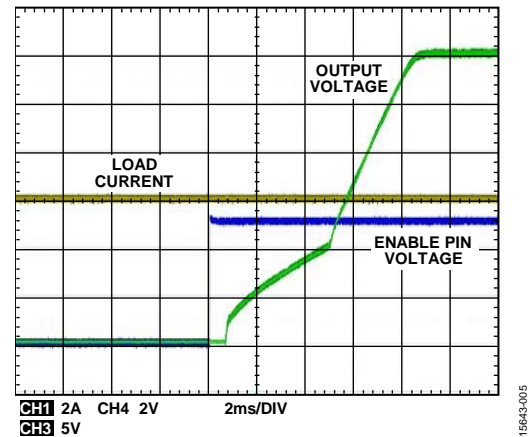

Figure 4. Soft Start at 48 V DC Input, 0 A Load

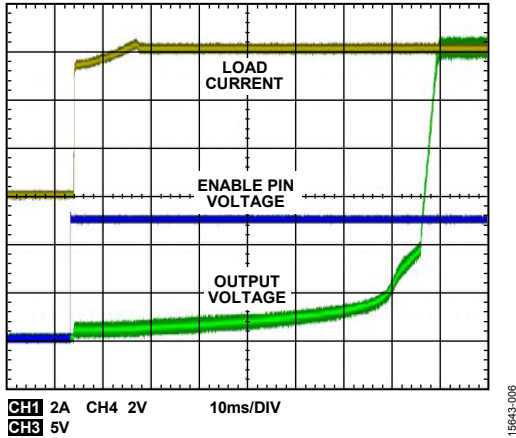

Figure 5. Soft Start at 48 VDC Input, 6 A Load

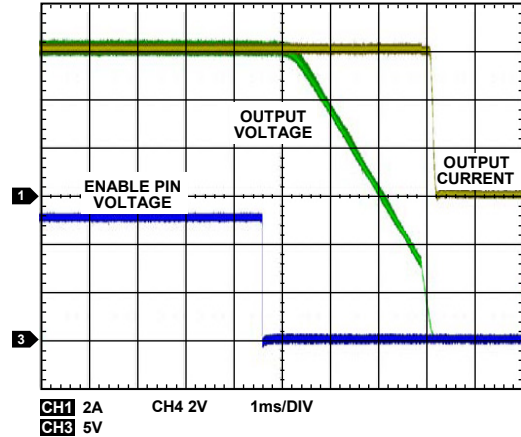

Figure 7. Soft Stop at 48 VDC Input, 6 A Load

When soft starting into a precharged output, the soft start scheme prevents the output from being discharged (and prevents reverse current) by tracking the SS2 pin to the FB pin voltage (see Figure 6).

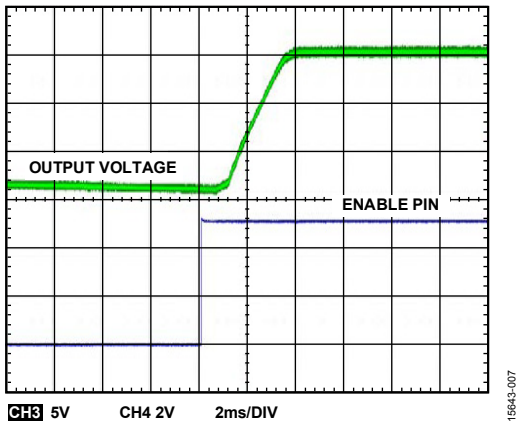

Figure 6. Soft Start from Precharge

Change the slope of the first stage of soft start by changing the SS1 capacitor. Alternate soft start slopes can be selected by changing the SS1 capacitor.

SOFT STOP

When the voltage at EN drops below the EN threshold, the secondary drivers shut off immediately while the primary NGATE pulse width gradually decreases to the minimum pulse width when the output drops. This soft stop feature prevents any reverse current when the controller shuts down when the EN pin is less than 1.2 V (see Figure 7).

OUTPUT RIPPLE

Output ripple can be measured across the C50 capacitor. Minimize the loop area formed by the probe and its grounding to create clean waveforms (see Figure 8 and Figure 9).

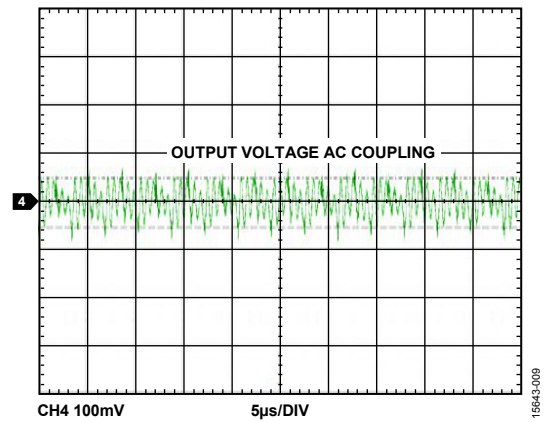

Figure 8. Output Ripple at 48 VDC Input, No Load

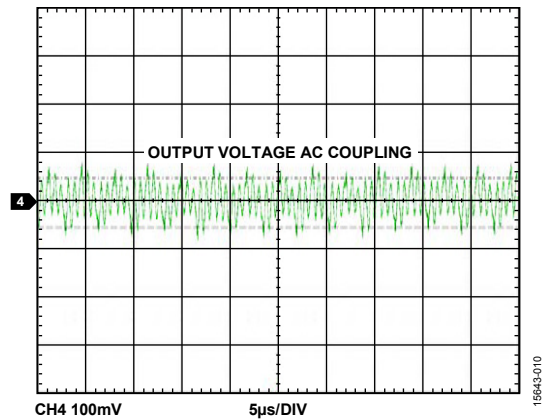

Figure 9. Output Ripple at 48 VDC Input, 6 A Load

CONTROL LOOP

On the secondary side, the output voltage information is sensed a voltage divider and sent to the FB pin. The FB pin voltage is compared to a 1.2 V reference signal, and the error determines the COMP pin voltage. The COMP voltage information is sent to the primary side via the iCoupler technology, allowing closed loop operation.

The loop gain can be measured via a loop analyzer. The small signal perturbation is injected between the output voltage and TP10 test point. The measurement probes of the network analyzer are connected at TP10.

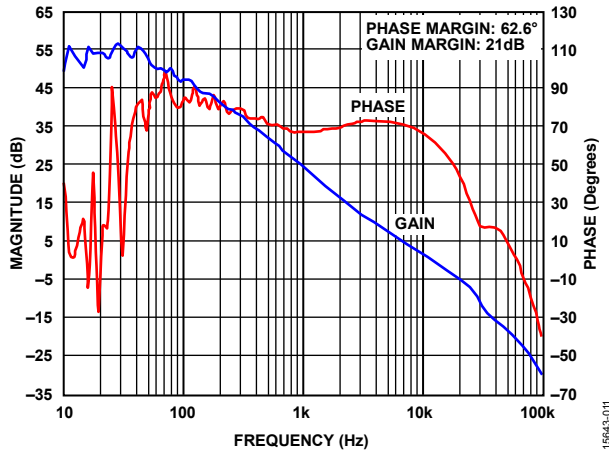

Figure 10. Loop Gain Measurement by AP200 Loop Analyzer; 48 V Input, 6 A Load, Crossover Frequency at 12.06 kHz Transient Response for Load Step

A dynamic electronic load can be connected to the output of the evaluation board to evaluate the transient response. Set up an oscilloscope to capture the transient waveform of the power supply output. Figure 11 shows an example of the load transient response. Change C40, R18, or C39 to desired values to measure the change of the loop gain and load dynamic response.

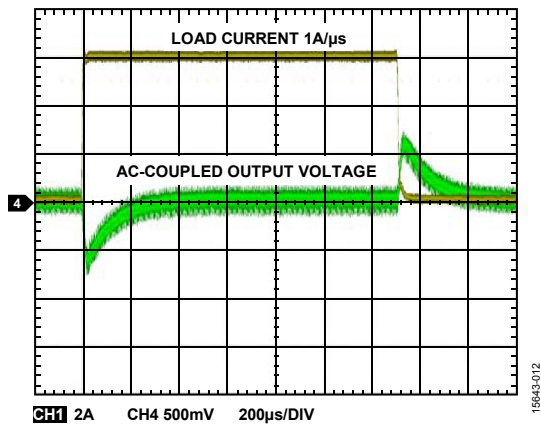

Figure 11. Transient Response with Load Steps, 0% to 100%

EXTERNAL SIGNAL TRACKING

The output voltage of the evaluation board can track an external signal applied to the SS2 pin. The applied peak value must be lower than 1.2 V dc. Figure 12 to Figure 14 show the tracking functionality.

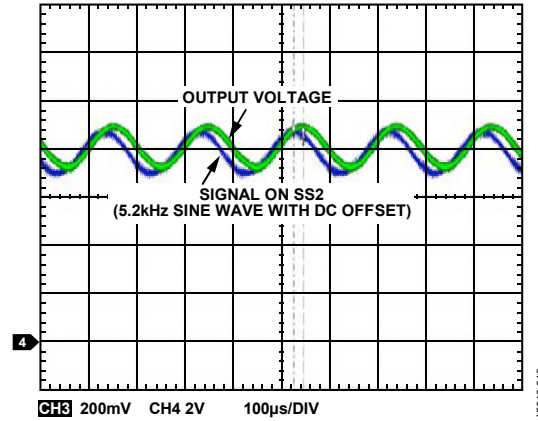

Figure 12. External Signal Tracking at 3 A Load

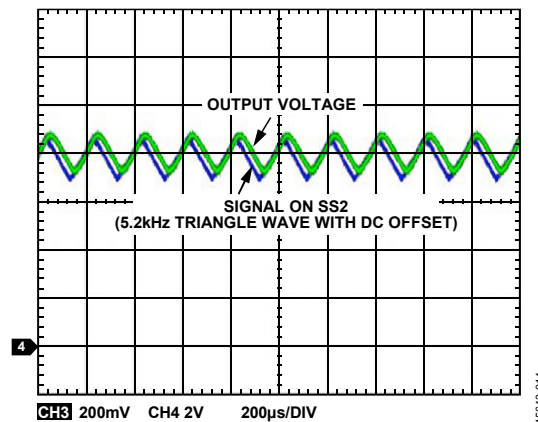

Figure 13. External Signal Tracking at 3 A load

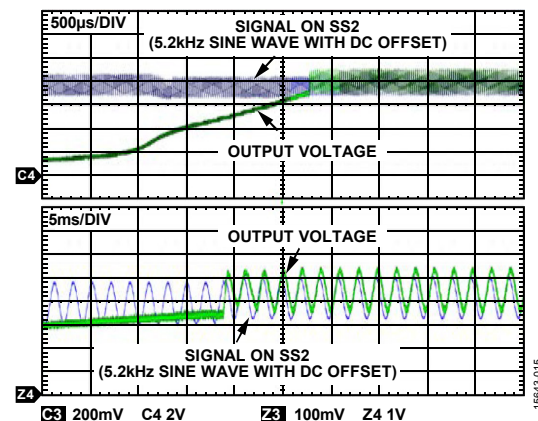

Figure 14. External Signal Tracking at 3 A Load During Start Up

OVER CURRENT PROTECTION

The primary peak current is sensed cycle by cycle by a current sensing resistor. When the sensed input peak current is above the CS pin limit threshold, the controller operates in the cycle by cycle constant current limit mode for 1.5 ms. The controller then immediately shuts down the primary drivers and discharges the SS2 pin. The controller goes into shutdown mode for the next 40 ms and restarts the soft start sequence. Figure 15 to Figure 17 show these protections features.

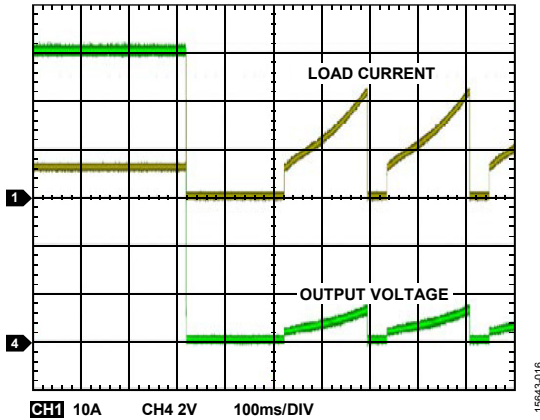

Figure 15. Over Current Protection (OCP) under Output Short Circuit at 48 V DC Input; the Under Voltage Lockout Threshold of the VDD2 Pin (VDD2_UVLO) Causes the First hiccup time of ~200 ms and the OCP Causes the Subsequent Hiccup Time of ~40 ms

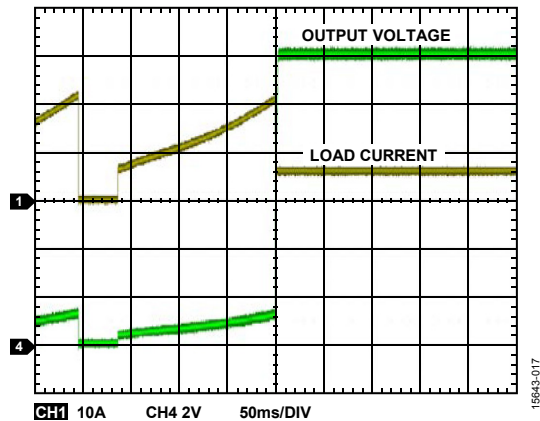

Figure 16. Recovery from Output Short Circuit at 48 V_{DC} and 6 A Load

OVERVOLTAGE PROTECTION

The ADP1074 offers overvoltage protection using the OVP pin. When the OVP voltage exceeds the threshold, the NGATE PWM and SRI PWM is terminated immediately until the next switching period (see Figure 17).

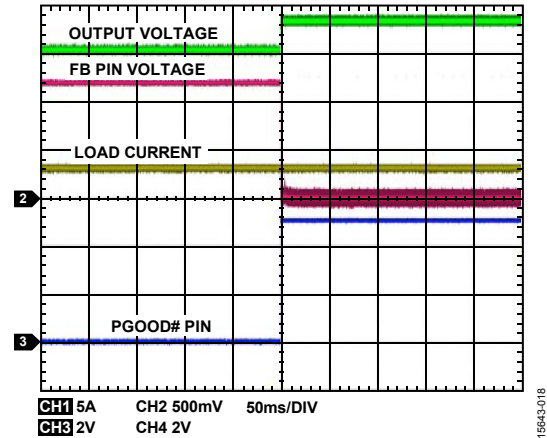

Figure 17. Overvoltage Protection (FB Pin Shorted to the ANG2 pin)

VOLTAGE AND CURRENT STRESS

Figure 18 and Figure 19 show the typical MOSFET drain to source voltage at the minimum and maximum input voltage conditions at 6 A load.

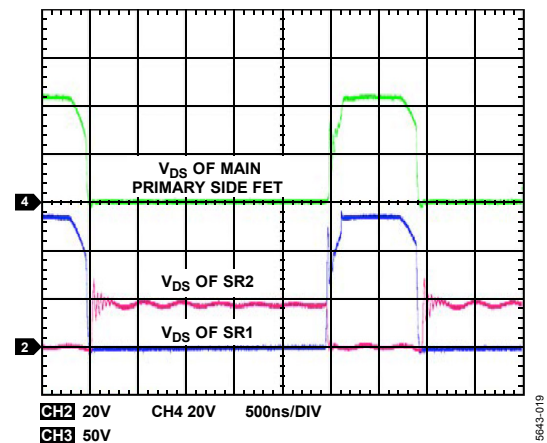

Figure 18. MOSFET Drain to Source Voltages (V_{DS}) at 36 V_{DC} Input and 6 A Load

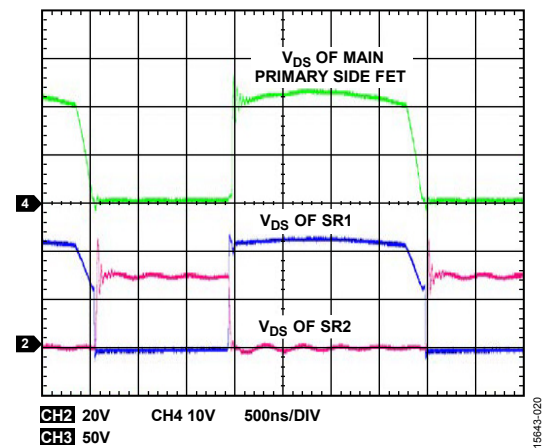

Figure 19. MOSFET V_{DS} at V_{DC} Input and 6 A Load

SR1 AND SR2 PINS AND PHASE IN FEATURE

Figure 20 to Figure 23 show the SR phase in feature and how SR1 and SR2 gradually phase into the required duty cycle commanded by the ADP1074.

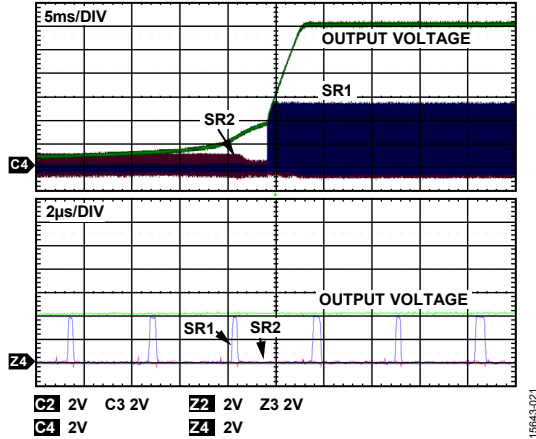

Figure 20. SR Phase In During Initial Stages

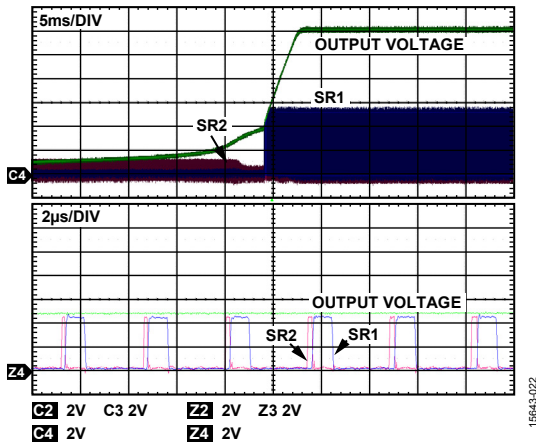

Figure 21. SR phase In During Interim Stages

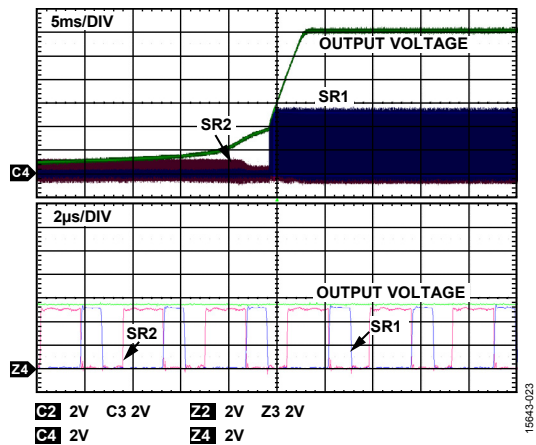

Figure 22. SR Phase In During Later Stages

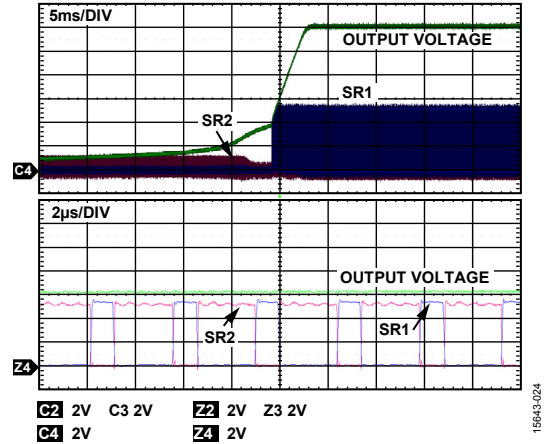

Figure 23. SR Phase In During Final Stages

OCF RECOVERY FEATURE

Figure 24 and Figure 25 show the OCF recovery during a load step and dump of 6 A to 14 A.

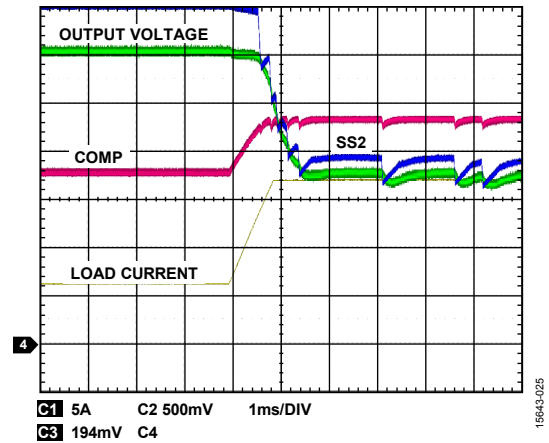

Figure 24. OCF Recovery During Load Step 6 A to 14 A

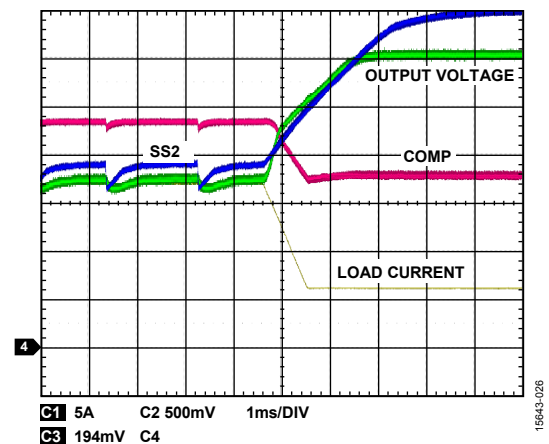

Figure 25. OCF Recovery During Load Dump, 14 A to 6 A

EFFICIENCY CURVES

Figure 26 and Figure 27 show the typical efficiency curves under load and line conditions, respectively. Figure 28 shows the typical output voltage regulation across the load.

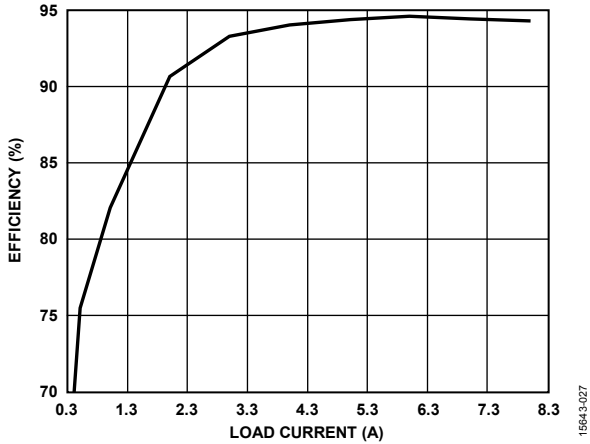

Figure 26. Efficiency Curves at 48 V_{DC}

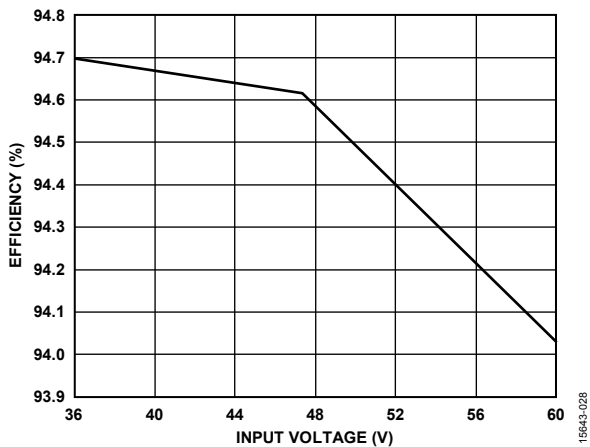

Figure 27. Efficiency Curves at 48 V_{DC}, 6 A Load

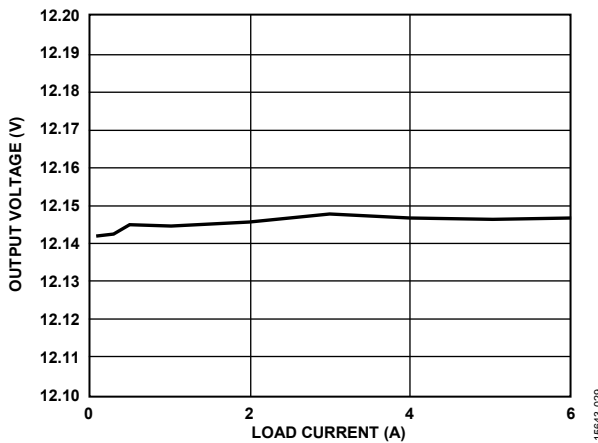

Figure 28. Load Regulation

THERMAL PERFORMANCE

Figure 29 to Figure 31 show the typical thermal profile of the evaluation board at different operating conditions.

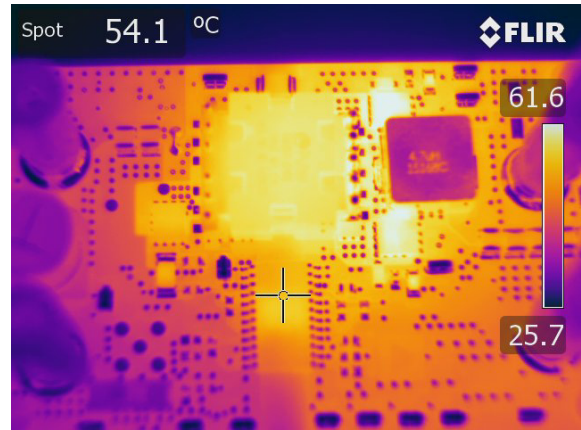

Figure 29. Thermal Image of ADP1074 at 48 V_{DC} Input, 6 A Load, No Airflow, 1 Hour Soaking Time



Figure 30. Thermal Image of SR1 at 48 V_{DC} Input, 6 A Load, No Airflow, 1 Hour Soaking Time

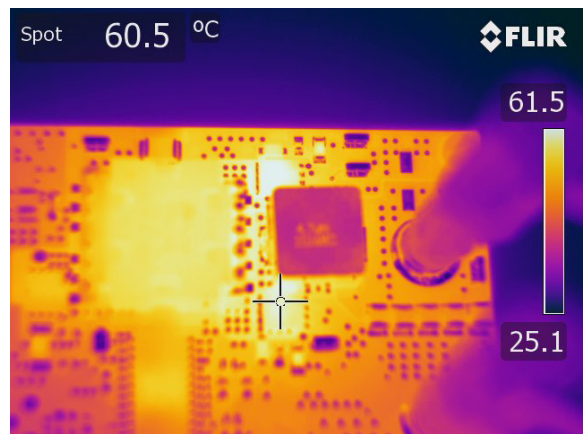

Figure 31. Thermal Image of SR2 at 48 V_{DC} Input, 6 A Load, No Airflow, 1 Hour Soaking Time

EVALUATION BOARD SCHEMATICS AND ARTWORK

15943-033

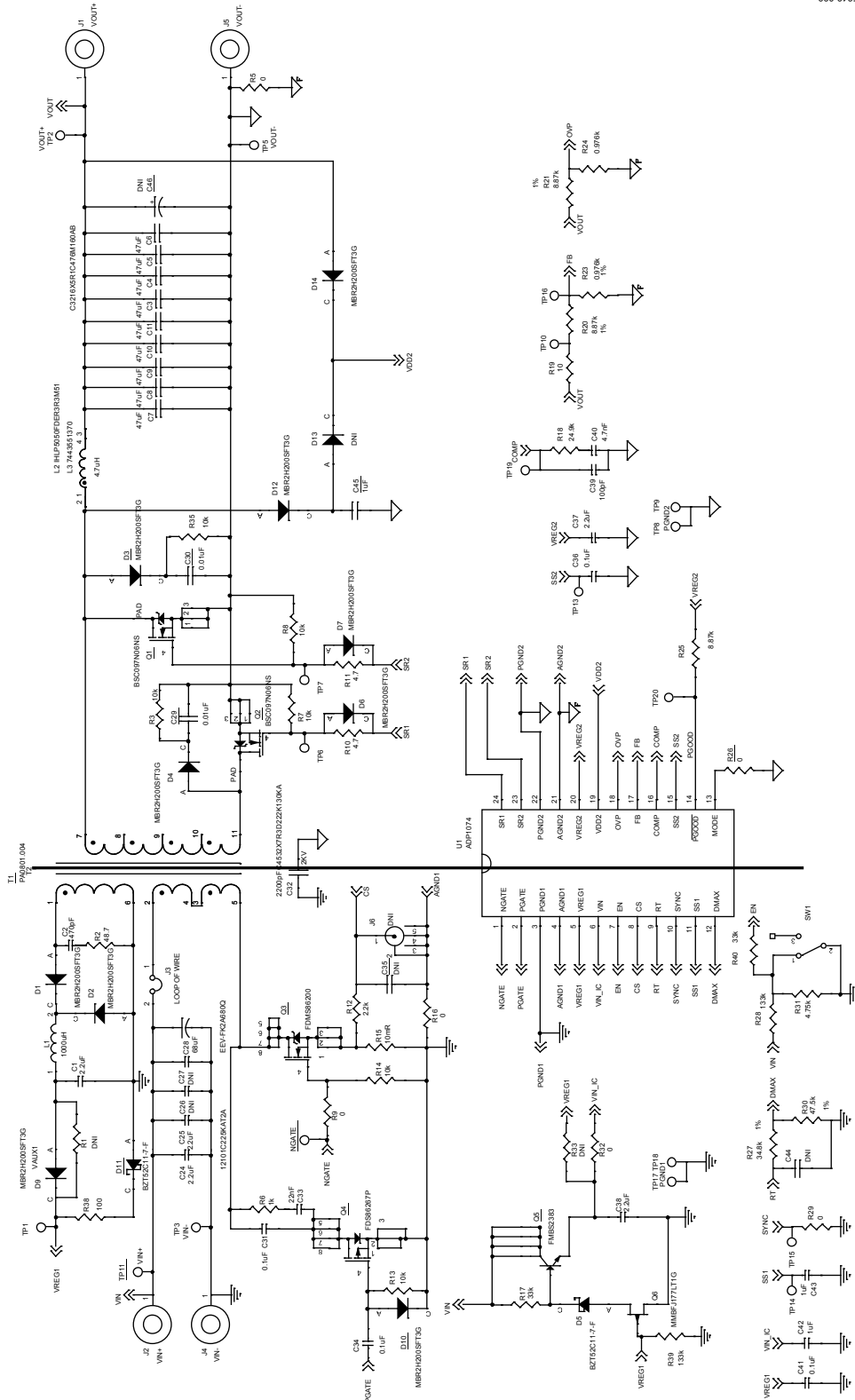

Figure 32. ADP1074 Evaluation Board Schematic

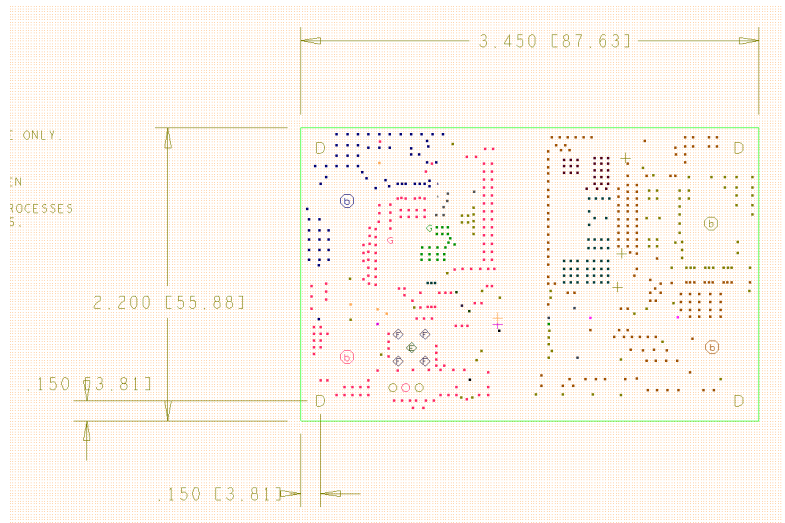

Figure 33. Evaluation Board Outline

15643-034

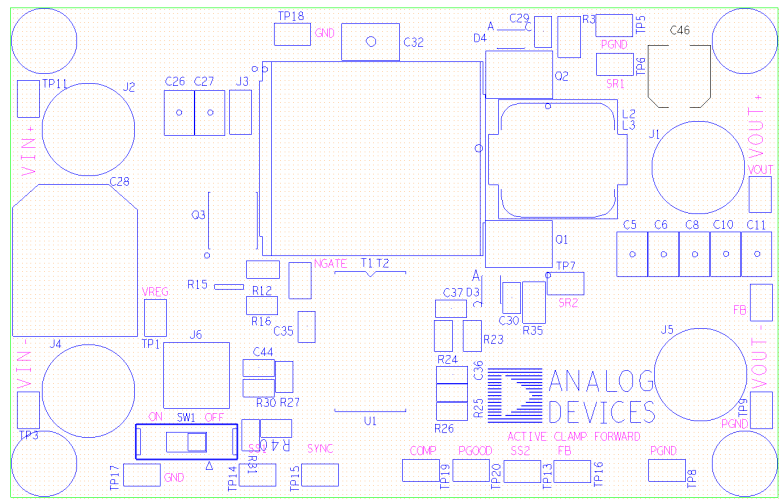

Figure 34. Silkscreen Top

15643-035

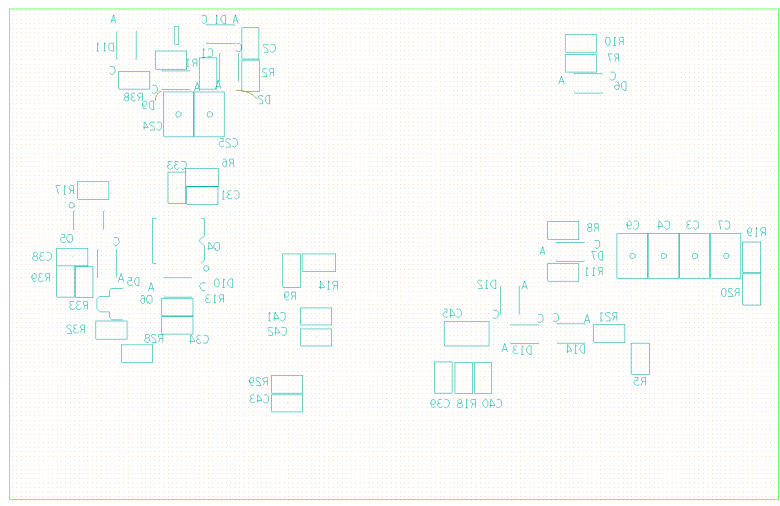

Figure 35. Silkscreen Bottom

15643-036

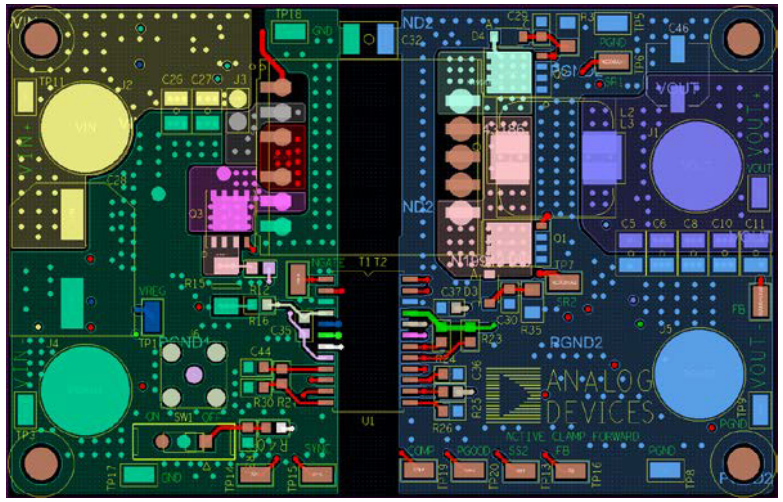

Figure 36. Printed Circuit Board (PCB) Layout, Top Layer

15643-037

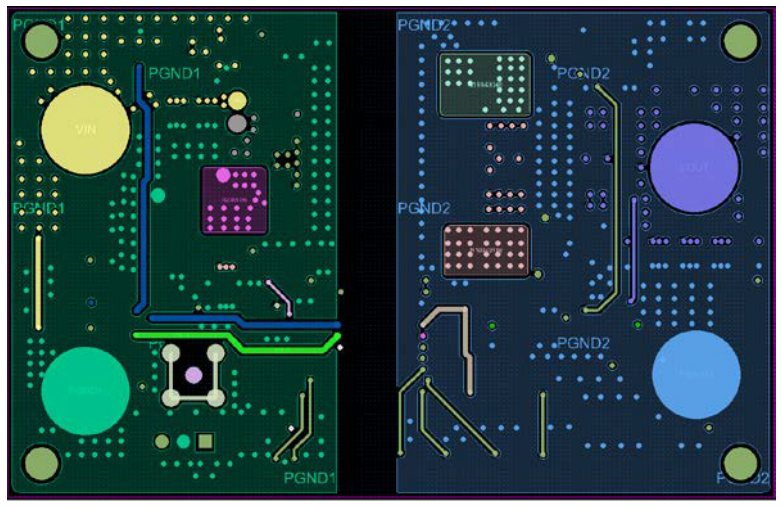

Figure 37. PCB Layout, Layer 2

15643-038

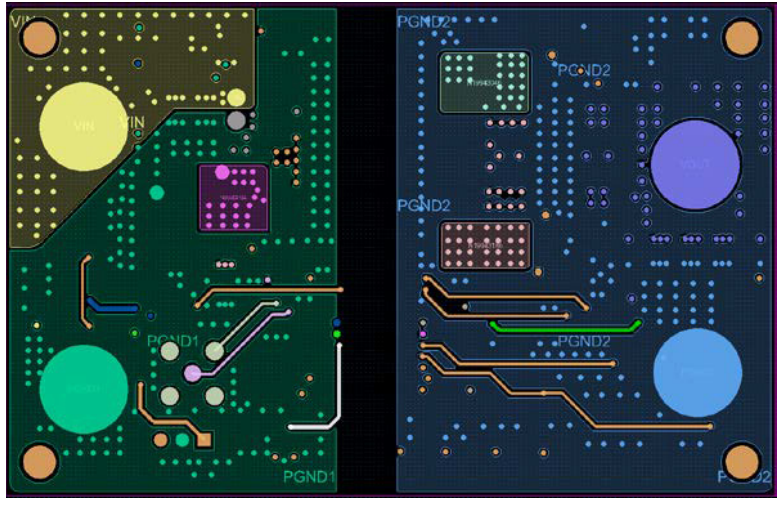

Figure 38. PCB Layout, Layer 3

15643-039

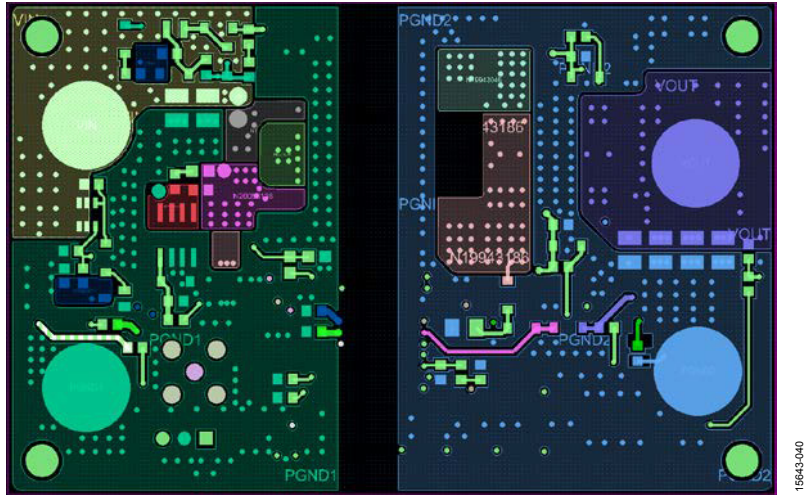

Figure 39. PCB Layout, Layer 4

ORDERING INFORMATION

BILL OF MATERIALS

Table 3. Evaluation Board Components List

Qty	Reference Designator	Description	Manufacturer	Part Number
2	C1	Capacitor, 2.2 μ F, 50 V, 0805, X7R	TDK	C2012X7R1H225K125AE
1	C2	Capacitor, 470 pF, 50V, 0805, X7R	Kemet	C0805C471K5RACTU
9	C3 to C11	Capacitors, 47 μ F, 16 V, 1210 X5R	TDK	GRM32ER61C476KE15
4	C24 to C27	Capacitors, 2.2 μ F, 100 V, 1210 X7R	AVX	12101C225KAT2A
1	C28	Capacitor, 68 μ F, 100 V, electrolytic	Panasonic	EEV-FK2A680Q
3	C29, C30, C33	Capacitors, 10 nF, 200 V, X7R	Kemet	C0603C103K2RACTU
1	C31	Capacitor, 22 nF, 250 V, X7R, 1206	TDK	C3216X7R2E223K115AA
1	C32	Capacitor, 2.2 nF, 2 kV, X7R, 1812, 2200 pF	TDK	C4532X7R3D222K130KA
3	C34, C36, C41	Capacitors, 0.1 μ F, 25 V, X7R, 0805	Murata	GRM21BR71E104KA01L
2	C35, C44	Capacitors, 100 pF, 10 V 0805, do not insert (DNI)	Kemet	C0603C101K5RACTU
1	C39	Capacitor, 100 pF, 10 V, X7R, 0805	Kemet	C0603C101K5RACTU
2	C37, C38	Capacitors, 2.2 μ F, 25 V, X7R, 0805	AVX	08053C225KAT2A
1	C40	Capacitor, 4.7 nF, NP0, 0805	Kemet	C0805C472J3GACTU
2	C42, C43	Capacitors, 1 μ F, 25 V, X5R, 0805	TDK	C2012X5R1E105K125AA
2	D12, D13	Diode 2A Schottkys, DNI	ON Semi	MBR2H200SFT3G
11	D1 to D4, D6, D7, D9, D10, D14	Diode 2A Schottkys	ON Semi	MBR2H200SFT3G
2	D11, D5	Zener diodes, 11 V, SOD123, BZT52C11-7-F	Diodes Inc.	BZT52C11-7-F
4	J1, J2, J4, J5	Connectors	Keystone	575-4K-ND
1	J3	Loop of wire, jumper	N/A	N/A
1	J6	Connector, BNC-RA, SMB, DNI	Emerson	131-3701-261
1	L1	Inductor 1 mH, 1.2 A	Taiyo Yuden	CB2518T102K
1	L2	Inductor, 4.7 μ H	Vishay	IHLP5050FDER4R7M01, alternate 744373965047
2	Q1, Q2	MOSFET N-channel, 60 V, 46 A, TDSO8-8	Infenion	BSC097N06NS
1	Q3	MOSFET N-channel, 150 V, 35 A (9.6 A continuous)	Fairchild	FDMS86200
1	Q4	MOSFET P-channel, 150 V, 1.4 A, 8-lead SOIC	Fairchild	FDS86267P
3	Q5	Transistor, NPN, 160 V, 0.8 A, 6-lead SSOT	Fairchild	FMBS2383
1	Q6	JFET P-channel, 30 V, 0.225 W, SOT23	ON Semi	MMBFJ177LT1G
1	R1	Resistor, 0603, 1%, DNI	N/A	N/A
1	R2	Resistor, 0603, 1%, 48.7	Vishay	CRCW060348R7FKEA
2	R3, R35,	Resistors, 1206, 1%, 10 k Ω	Vishay	CRCW120610K0FKEA
5	R5, R16, R26, R29, R32	Resistors, 0603, 1%, 0 Ω	Vishay	CRCW06030000Z0EA
1	R6	Resistor, 0805, 1%, 1 k Ω	Vishay	CRCW08051K00FKEA
3	R7, R8, R13	Resistors, 0603, 1%, 10 k Ω	Vishay	CRCW060310K0FKEA
1	R9	Resistor, 0805, 1%, 0 Ω	Vishay	CRCW08050000Z0EA
2	R10, R11	Resistors, 0603, 1%, 4.7 Ω	Vishay	CRCW06034R70FKEA
1	R12	Resistor, 0805, 1%, 2.2 k Ω	Vishay	CRCW08052K20FKEA
1	R14	Resistor, 0805, 1%, 10 k Ω	Vishay	CRCW080510K0FKEA
1	R15	Resistor, 2010, 10 m Ω	Vishay	WSL2010R0100FEA
2	R17, R40	Resistors, 0603, 1%, 33 k Ω	Vishay	CRCW060333K0FKEA
1	R18	Resistor, 0603, 1%, 24.9 k Ω	Vishay	CRCW060324K9FKEA
1	R19	Resistor, 0603, 1%, 10 Ω	Vishay	CRCW060310R0FKEA

Qty	Reference Designator	Description	Manufacturer	Part Number
3	R20, R21, R25	Resistors, 0603, 1%, 8.87 k Ω	Vishay	RC0603FR-078K87L
2	R23, R24	Resistors, 0603, 1%, 0.976 k Ω	Vishay	CRCW0603976RFKEA
1	R27	Resistor, 0603, 1%, 34.8 k Ω	Vishay	CRCW0603348KFKEA
2	R28, R39	Resistors, 0603, 1%, 133 k Ω	Vishay	CRCW0603133KFKEA
2	R30, R31	Resistors, 0603, 1%, 47.5 k Ω	Vishay	CRCW0603475KFKEA
1	R33	Resistor, 0603, 1%, DNI	Vishay	
1	R38	Resistor, 0603, 1%, 100 Ω	Vishay	CRCW0603100RFKEA
1	SW1	Switch, slide single-pole, double-throw, 30 V, 0.2 A, PC mount	E-Switch	EG1218
1	T1	Transformer	Pulse Eng	PA0801.004NL
20	TP1, TP3, TP5 to TP9, TP11, TP13 to TP20, NGATE, FB, VOUT	Test points	Keystone	5019
1	Power controller	IC	Analog Devices	ADP1074
4	On 4 corners of the evaluation board	Hexidecimal, 4-40, nylon, 1/2", stand off	Keystone	1902C
4	On 4 corners of the evaluation board	Machine screw, Pan Phillips 4-40	B7F Fastener Supply	NY PMS 440 0025 PH
1	R41	Resistor, 0 Ω , DNI	Not applicable	Not applicable
DNI	C45	Capacitor, 1206, 1 μ F, 100 V	AVX	12061C105KAT2A
DNI	C46	Capacitor, 16 V, 120 μ F, DNI	Panasonic	16SVPC120M

**ESD Caution**

ESD (electrostatic discharge) sensitive device. Charged devices and circuit boards can discharge without detection. Although this product features patented or proprietary protection circuitry, damage may occur on devices subjected to high energy ESD. Therefore, proper ESD precautions should be taken to avoid performance degradation or loss of functionality.

Legal Terms and Conditions

By using the evaluation board discussed herein (together with any tools, components documentation or support materials, the "Evaluation Board"), you are agreeing to be bound by the terms and conditions set forth below ("Agreement") unless you have purchased the Evaluation Board, in which case the Analog Devices Standard Terms and Conditions of Sale shall govern. Do not use the Evaluation Board until you have read and agreed to the Agreement. Your use of the Evaluation Board shall signify your acceptance of the Agreement. This Agreement is made by and between you ("Customer") and Analog Devices, Inc. ("ADI"), with its principal place of business at One Technology Way, Norwood, MA 02062, USA. Subject to the terms and conditions of the Agreement, ADI hereby grants to Customer a free, limited, personal, temporary, non-exclusive, non-sublicensable, non-transferable license to use the Evaluation Board FOR EVALUATION PURPOSES ONLY. Customer understands and agrees that the Evaluation Board is provided for the sole and exclusive purpose referenced above, and agrees not to use the Evaluation Board for any other purpose. Furthermore, the license granted is expressly made subject to the following additional limitations: Customer shall not (i) rent, lease, display, sell, transfer, assign, sublicense, or distribute the Evaluation Board; and (ii) permit any Third Party to access the Evaluation Board. As used herein, the term "Third Party" includes any entity other than ADI, Customer, their employees, affiliates and in-house consultants. The Evaluation Board is NOT sold to Customer; all rights not expressly granted herein, including ownership of the Evaluation Board, are reserved by ADI. CONFIDENTIALITY. This Agreement and the Evaluation Board shall all be considered the confidential and proprietary information of ADI. Customer may not disclose or transfer any portion of the Evaluation Board to any other party for any reason. Upon discontinuation of use of the Evaluation Board or termination of this Agreement, Customer agrees to promptly return the Evaluation Board to ADI. ADDITIONAL RESTRICTIONS. Customer may not disassemble, decompile or reverse engineer chips on the Evaluation Board. Customer shall inform ADI of any occurred damages or any modifications or alterations it makes to the Evaluation Board, including but not limited to soldering or any other activity that affects the material content of the Evaluation Board. Modifications to the Evaluation Board must comply with applicable law, including but not limited to the RoHS Directive. TERMINATION. ADI may terminate this Agreement at any time upon giving written notice to Customer. Customer agrees to return to ADI the Evaluation Board at that time. LIMITATION OF LIABILITY. THE EVALUATION BOARD PROVIDED HEREUNDER IS PROVIDED "AS IS" AND ADI MAKES NO WARRANTIES OR REPRESENTATIONS OF ANY KIND WITH RESPECT TO IT. ADI SPECIFICALLY DISCLAIMS ANY REPRESENTATIONS, ENDORSEMENTS, GUARANTEES, OR WARRANTIES, EXPRESS OR IMPLIED, RELATED TO THE EVALUATION BOARD INCLUDING, BUT NOT LIMITED TO, THE IMPLIED WARRANTY OF MERCHANTABILITY, TITLE, FITNESS FOR A PARTICULAR PURPOSE OR NON-INFRINGEMENT OF INTELLECTUAL PROPERTY RIGHTS. IN NO EVENT WILL ADI AND ITS LICENSORS BE LIABLE FOR ANY INCIDENTAL, SPECIAL, INDIRECT, OR CONSEQUENTIAL DAMAGES RESULTING FROM CUSTOMER'S POSSESSION OR USE OF THE EVALUATION BOARD, INCLUDING BUT NOT LIMITED TO LOST PROFITS, DELAY COSTS, LABOR COSTS OR LOSS OF GOODWILL. ADI'S TOTAL LIABILITY FROM ANY AND ALL CAUSES SHALL BE LIMITED TO THE AMOUNT OF ONE HUNDRED US DOLLARS (\$100.00). EXPORT. Customer agrees that it will not directly or indirectly export the Evaluation Board to another country, and that it will comply with all applicable United States federal laws and regulations relating to exports. GOVERNING LAW. This Agreement shall be governed by and construed in accordance with the substantive laws of the Commonwealth of Massachusetts (excluding conflict of law rules). Any legal action regarding this Agreement will be heard in the state or federal courts having jurisdiction in Suffolk County, Massachusetts, and Customer hereby submits to the personal jurisdiction and venue of such courts. The United Nations Convention on Contracts for the International Sale of Goods shall not apply to this Agreement and is expressly disclaimed.

©2017-2018 Analog Devices, Inc. All rights reserved. Trademarks and registered trademarks are the property of their respective owners.
UG15643-0-1/18(A)



www.analog.com