

LTM4686

Ultrathin Dual 10A or Single 20A μ Module Regulator With Digital Power System Management

DESCRIPTION

Demonstration circuit 2722A is a dual-output, high efficiency, high density, μ Module regulator with 2.7V to 17V input range. Each output can supply 10A maximum load current. The demo board has a [LTM4686](#) μ Module regulator, which is a dual 10A or single 20A step-down regulator with digital power system management. Please see LTM4686 data sheet for more detailed information.

DC2722A powers up to default settings and produce power based on configuration resistors without the need for any serial bus communication. This allows easy evaluation of the DC/DC converter. To fully explore the extensive power system management features of the part, download the GUI software LTpowerPlay™ onto your PC and use LTC's I²C/SMBus/PMBus dongle DC1613A to connect to

the board. LTpowerPlay allows the user to reconfigure the part on the fly and store the configuration in EEPROM, view telemetry of voltage, current, temperature and fault status.

GUI Download

The software can be downloaded from: [ltpowerplay](http://www.linear.com/ltpowerplay)

For more details and instructions of LTpowerPlay, please refer to LTpowerPlay GUI for LTM4686 Quick Start Guide.

Design files for this circuit board are available at <http://www.analog.com/DC2722A>

All registered trademarks and trademarks are the property of their respective owners.

BOARD PHOTO

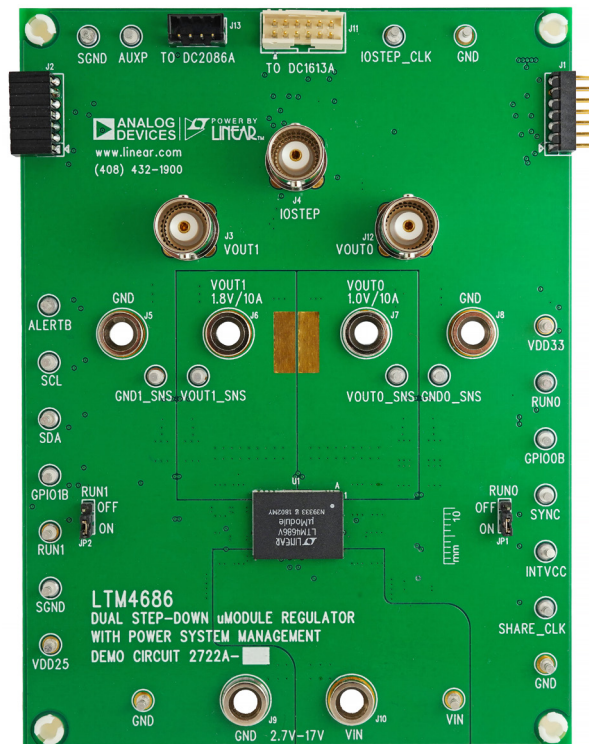

Figure 1. Dual-Output LTM4686/DC2722A Demo Circuit

DEMO MANUAL DC2722A

PERFORMANCE SUMMARY Specifications are at $T_A = 25^\circ\text{C}$

PARAMETER	CONDITIONS	VALUE
Input Voltage Range		2.7V to 17V
Output Voltage, V_{OUT0}	$V_{IN} = 2.7\text{-}17\text{V}$, $I_{OUT0} = 0\text{A to }10\text{A}$	0.5V to 3.6V, Default: 1.0V
Maximum Output Current, I_{OUT0}	$V_{IN} = 2.7\text{-}17\text{V}$, $V_{OUT0} = 0.5\text{V to }3.6\text{V}$	10A
Output Voltage, V_{OUT1}	$V_{IN} = 2.7\text{-}17\text{V}$, $I_{OUT1} = 0\text{A to }10\text{A}$	0.5V to 3.6V, Default: 1.8V
Maximum Output Current, I_{OUT1}	$V_{IN} = 2.7\text{-}17\text{V}$, $V_{OUT1} = 0.5\text{V to }3.6\text{V}$	10A
Typical Efficiency	$V_{IN} = 12\text{V}$, $V_{OUT0} = 1.0\text{V}$, $I_{OUT0} = 10\text{A}$	79.3% (See Figure 5)
	$V_{IN} = 12\text{V}$, $V_{OUT1} = 1.8\text{V}$, $I_{OUT1} = 10\text{A}$	85.7% (See Figure 6)
Default Switching Frequency		500kHz

QUICK START PROCEDURE

Demonstration circuit 2722A is easy to set up to evaluate the performance of the LTM4686EV. Refer to Figure 2 for the proper measurement equipment setup and follow the procedure below.

1. With power off, connect the input power supply to V_{IN} (2.7V-17V*) and GND (input return).
2. Connect the 1.0V output load between V_{OUT0} and GND (Initial load: no load).
3. Connect the 1.8V output load between V_{OUT1} and GND (Initial load: no load).
4. Connect the DVMs to the input and outputs. Set default jumper position: JP1: ON; JP2: ON.
5. Turn on the input power supply and check for the proper output voltages. V_{OUT0} should be $1.0\text{V} \pm 0.5\%$, and V_{OUT1} should be $1.8\text{V} \pm 0.5\%$.
6. Once the proper output voltages are established, adjust the loads within the operating range and observe the output voltage regulation, ripple voltage and other parameters.
7. Connect the dongle and control the output voltages from the GUI. See "LTpowerPlay GUI for the LTM4686 Quick Start Guide" for details.

Note: When measuring the output or input voltage ripple, do not use the long ground lead on the oscilloscope probe. See Figure 3 for the proper scope probe technique. Short, stiff leads need to be soldered to the (+) and (-) terminals of an output capacitor. The probe's ground ring needs to touch the (-) lead and the probe tip needs to touch the (+) lead.

- * a) When $5.75\text{V} < V_{IN} < 17\text{V}$,
LTM4686 PMBus COMMAND CODE are $V_{IN_ON}=5.50\text{V}$, $V_{IN_OFF}=5.25\text{V}$, $V_{IN_UV_WARN_LIMIT}=5.30\text{V}$;
 $R9=0\text{ohm}$, $R8=R91=R92=OPEN$
- b) When $2.70\text{V} < V_{IN} < 5.75\text{V}$,
LTM4686 PMBus COMMAND CODE are $V_{IN_ON}=4.25\text{V}$, $V_{IN_OFF}=4.00\text{V}$, $V_{IN_UV_WARN_LIMIT}=4.09\text{V}$;
- If $2.70\text{V} < V_{IN} < 5.50\text{V}$,
 $R9=OPEN$, $R8=R91=R92=0\text{ohm}$
- If $4.50\text{V} < V_{IN} < 5.75\text{V}$,
 $R9=R8=0\text{ohm}$, $R91=R92=OPEN$

QUICK START PROCEDURE

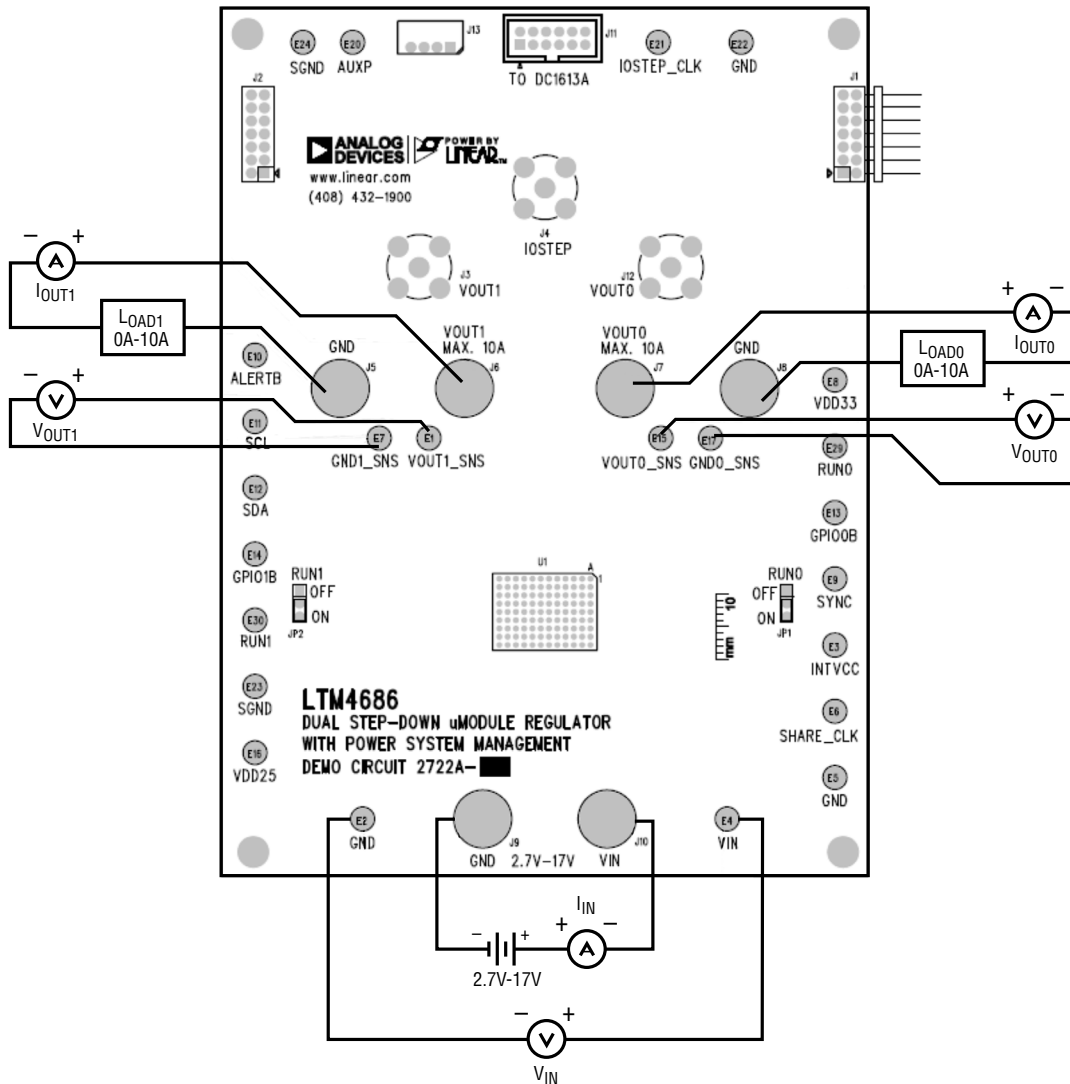

Figure 2. Proper Measurement Equipment Setup

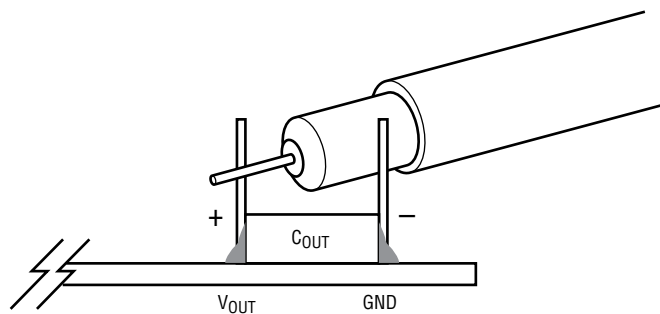

Figure 3. Measuring Output Voltage Ripple

DEMO MANUAL DC2722A

QUICK START PROCEDURE

Connecting a PC to DC2722A

You can use a PC to reconfigure the power management features of the LTM4686 such as: nominal V_{OUT} , margin set points, OV/UV limits, temperature fault limits,

sequencing parameters, the fault log, fault responses, GPIOs and other functionalities. The DC1613A dongle may be plugged when V_{IN} is present.

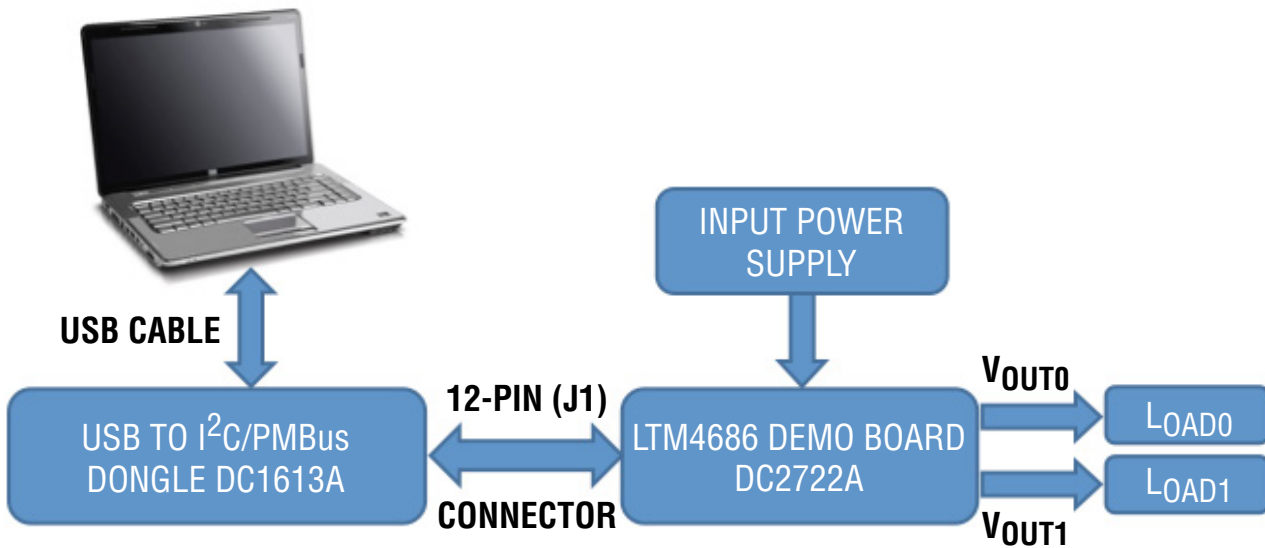
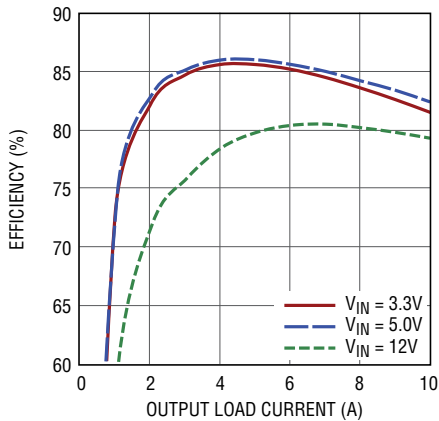

Figure 4. Demo Setup with PC

Efficiency vs Load Current at $V_O = 1.0V$, $f_{SW} = 500kHz$



DC2722A F05

Figure 5. Efficiency vs Load Current on CH0 (CH1 is Disabled)

Efficiency vs Load Current at $V_O = 1.8V$, $f_{SW} = 500kHz$

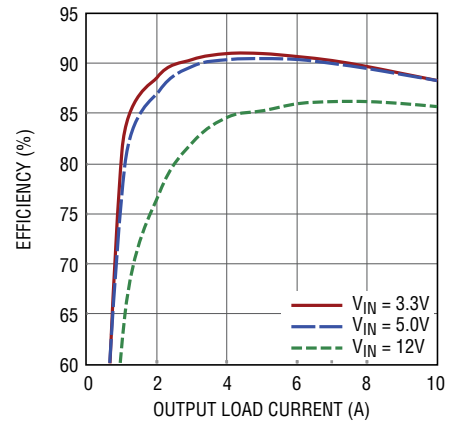

DC2722A F06

Figure 6. Efficiency vs Load Current on CH1 (CH0 is Disabled)

QUICK START PROCEDURE

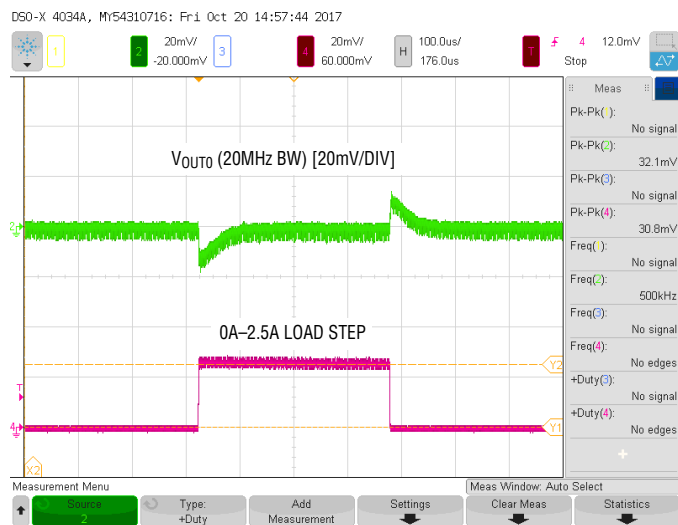

Figure 7. Output Voltage V_{OUT0} vs Load Current ($V_{OUT0} = 1.0V$)

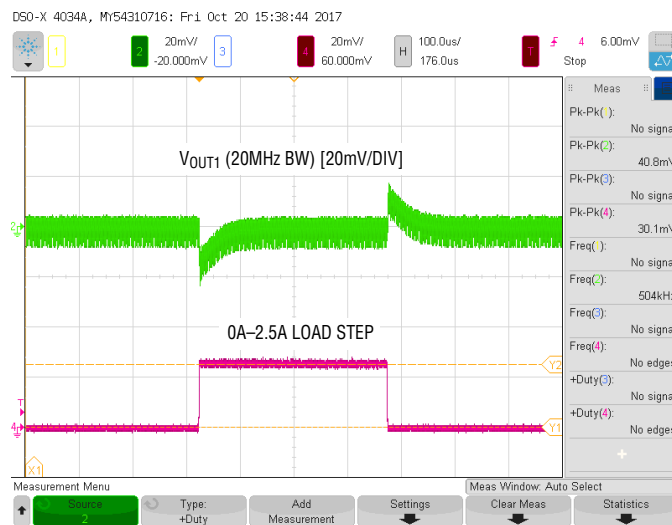

Figure 8. Output Voltage V_{OUT1} vs Load Current ($V_{OUT1} = 1.8V$)



Figure 9. Output Voltage Ripple at $V_{IN} = 12V$, $V_{OUT0} = 1.0V$, $I_{OUT0} = 10A$



Figure 10. Output Voltage Ripple at $V_{IN} = 12V$, $V_{OUT1} = 1.8V$, $I_{OUT1} = 10A$

QUICK START PROCEDURE



Figure 11. Thermal at $V_{IN} = 12V$, $V_{OUT0} = 1.0V$, $I_{OUT0} = 10A$, $V_{OUT1} = 1.8V$, $I_{OUT1} = 10A$, $T_A = 25^\circ C$, No Airflow

LTPOWERPLAY SOFTWARE GUI

LTpowerPlay is a powerful Windows based development environment that supports Linear Technology power system management ICs and μ Modules, including the LTM4675, LTM4676, LTM4677, LTM4686, LTC3880, LTC3882 and LTC3883. The software supports a variety of different tasks. You can use LTpowerPlay to evaluate Linear Technology ICs by connecting to a demo board system. LTpowerPlay can also be used in an offline mode (with no hardware present) in order to build a multichip configuration file that can be saved and reloaded at a later time. LTpowerPlay provides unprecedented diagnostic and debug features. It becomes a valuable diagnostic tool during board bring-up to program or tweak the power management scheme in a system, or to diagnose power issues when bringing up rails. LTpowerPlay utilizes the

DC1613A USB-to-SMBus controller to communicate with one of many potential targets, including the LTM4675, LTM4676, LTM4677, LTM4686, LTC3880, LTC3882, LTC3883's demo system, or a customer board. The software also provides an automatic update feature to keep the software current with the latest set of device drivers and documentation. The LTpowerPlay software can be downloaded from: [ltpowerplay](http://ltpowerplay.com)

To access technical support documents for LTC Digital Power Products visit the LTpowerPlay Help menu. Online help also available through the LTpowerPlay.

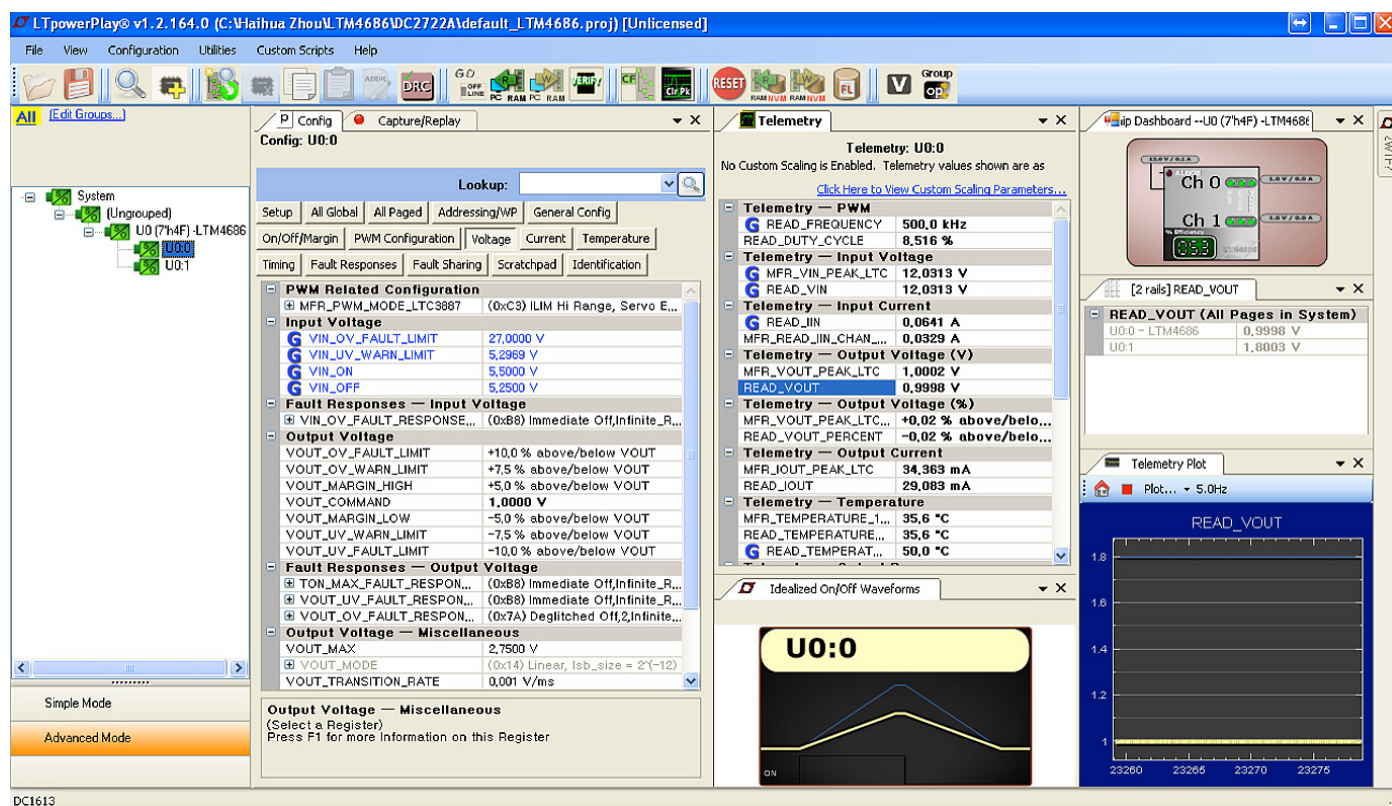

Figure 12. LTpowerPlay Main Interface

LTPowerPLAY QUICK START PROCEDURE

The following procedure describes how to use LTpowerPlay to monitor and change the settings of LTM4686.

1. Download and install the LTPowerPlay GUI:

[ltpowerplay](#)

2. Launch the LTpowerPlay GUI.

- a. The GUI should automatically identify the DC2722A. The system tree on the left-hand side should look like this:

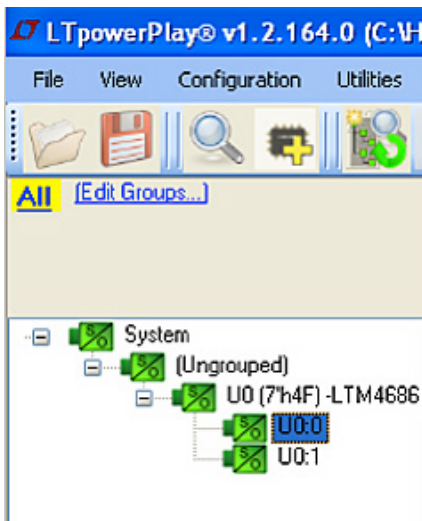

- b. A green message box shows for a few seconds in the lower left hand corner, confirming that LTM4686 is communicating:

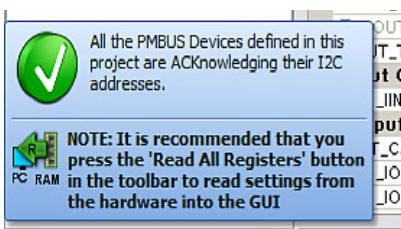

- c. In the Toolbar, click the “R” (RAM to PC) icon to read the RAM from the LTM4686. This reads the configuration from the RAM of LTM4686 and loads it into the GUI.



- d. If you want to change the output voltage to a different value, like 1.5V. In the Config tab, type in 1.5 in the VOUT_COMMAND box, like this:

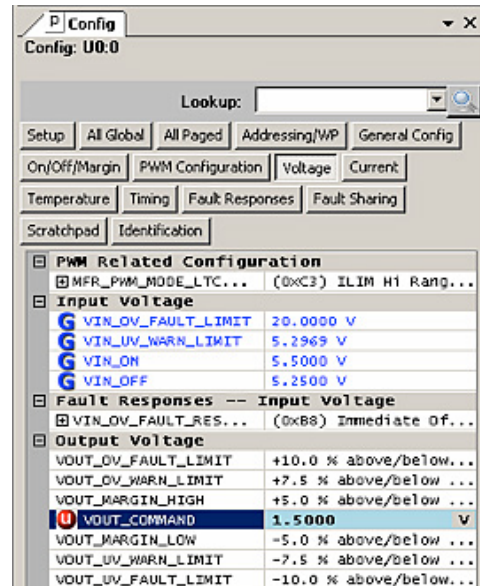

Then, click the “W” (PC to RAM) icon to write these register values to the LTM4686. After finishing this step, you will see the output voltage will change to 1.5V.



If the write is successful, you will see the following message:

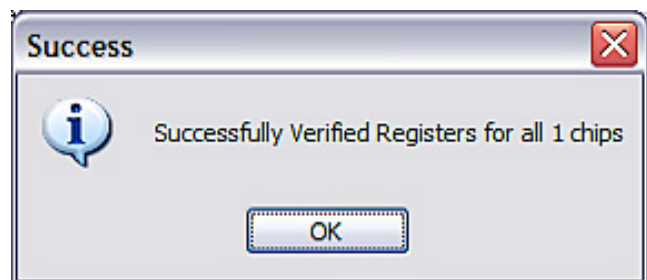

- e. You can save the changes into the NVM. In the tool bar, click “RAM to NVM” button, as following:



- f. Save the demo board configuration to a (*.proj) file. Click the Save icon and save the file. Name it whatever you want.

PARTS LIST

ITEM	QTY	REFERENCE	PART DESCRIPTION	MANUFACTURER/PART NUMBER
Required Circuit Components				
1	1	CIN1	Cap., 150µF, 35V, ALUM POLY HYB	PANASONIC, EEH-ZA1V151P
2	2	CIN2, CIN4	CAP, 22µF, 25V, 10%, X5R, 1210	MURATA, GRM32ER61E226KE15L
3	0	CIN3, CIN5 (OPT)	Cap., 1210	OPT
4	6	COUT1-COUT3, COUT6-COUT8	Cap., 100µF, X5R, 6.3V, 20%, 1210	AVX, 12106D107MAT2A
5	4	COUT4, COUT5, COUT9, COUT10	POSCAP, 330µF 4V	PANASONIC, 4TPE330MI
6	0	C1, C2, C15-C17 (OPT)	Cap., 0603	OPT
7	2	C1, C14	Cap., 1.5nF, X5R, 25V, 10%, 0603	
8	1	C2	Cap., 56pF, X5R, 25V, 10%, 0603	
9	3	C21, C22, C24	Cap., 1µF, X5R, 25V, 10%, 0603	AVX, 06033D105KAT2A
10	1	C23	Cap., 1µF, X7R, 25V, 10%, 0805	AVX, 08053C105KAT2A
11	1	C26	Cap., 0.1µF, X5R, 25V, 10%, 0603	AVX, 06033D104KAT2A
12	2	C27, C28	Cap., X5R, 0.01µF, 25V, 10%, 0603	AVX, 06033D103KAT2A
13	2	C29, C30	CAP, X5R, 4.7µF, 16V, 10%, 0603	TDK, C1608X5R1C475K080AC
14	1	C31	CAP, X7R, 2.2µF, 10V, 10%, 0603	TDK, C1608X7R1A225K080AC
15	0	D1, D2 (OPT)	DIODE, SOD323	OPT
16	1	D8	DIODE, ULTRA LOW SCHOTTKY RECTIFIER	NXP SEMI. PMEG2005AEL
17	2	JP1, JP2	HEADER, 3 PIN, 0.079, SINGLE ROW	SULLINS, NRPN031PAEN-RC
18	1	J1	CONN., HEADER, 2×7, 2mm, R/A (M)	MOLEX, 87760-1416
19	1	J2	CONN., HEADER, 2×7, 2mm, R/A (F)	SULLINS, NPPN072FJFN-RC
20	3	J3, J4, J12	CONN., BNC PC MOUNT RECEPT. JACK, 50Ω, TF-4 POST	AMPHENOL CONNEX, 112404
21	1	J11	CONN HEADER 12POS 2mm STR DL	FCI, 98414-G06-12ULF
22		J13	HEADER, 4 PINS, SHROUDED	HIROSE, DF3A-4P-2DSA
23	24	E1-E27, E20-E24, E29, E30	TESTPOINT, TURRET, .062"	MILL-MAX, 2308-2-00-80-00-00-07-0
24	6	J5-J10	BANANA JACK, NON-INSULATED .218"	KEYSTONE, 575-4
25	1	Q1	MOSFET, N-CH 40V, 50A, TO-252	VISHAY, SUD50N04-8M8P-4GE3
26	1	Q19	MOSFET, P-CH 30V, 3.5A, SOT-23	DIODES., DMP3130L-7
27	11	R3, R5, R7, R9, R25, R31, R32, R63, R65, R66, R93	Res., CHIP, 0 1%, 0603	VISHAY, CRCW06030000Z0EA
28	0	R2, R6, R8, R22, R23, R26, R28, R35, R38, R41, R42, R61, R62, R64, R67, R68, R74, R75, R83, R88, R89, R91, R92	RES., 0603	OPT
29	12	R10-R16, R18, R19, R24, R52, R77	RES., CHIP, 10k, 1%, 0603	VISHAY, CRCW060310K0FKEA
30	2	R2, R22	RES., CHIP, 21k, 1%, 0603	VISHAY, CRCW060321K0FKEA
31	1	R27	RES., CHIP, 6.34k, 1%, 0603	VISHAY, CRCW06036K34FKEA
32	1	R28	RES., CHIP, 1.65k, 1%, 0603	VISHAY, CRCW06031K65FKEA
33	2	R29, R31	RES., CHIP, 32.4k, 1%, 0603	VISHAY, CRCW060332K4FKEA
34	1	R30	RES., CHIP, 5.23k, 1%, 0603	VISHAY, CRCW06035K23FKEA
35	2	R72, R73	RES., CHIP, 4.99k, 1%, 0603	VISHAY, CRCW06034K99FKEA

DEMO MANUAL DC2722A

PARTS LIST

ITEM	QTY	REFERENCE	PART DESCRIPTION	MANUFACTURER/PART NUMBER
36	1	R48	RES., CHIP, 0 Ω ,3/4W, 2010, SMD	VISHAY, CRCW20100000Z0EF
37	0	R49	RES., 2010	OPT
38	0	R50, R51	RES., CHIP, 30, 1%, 2512	OPT
39	1	R53	RES., CHIP, 0.01, 1/2W, 1%, 2010	IRC., LRF2010LF-01-R010-F
40	2	R69, R70	RES., CHIP, 10, 1%, 0603	VISHAY, CRCW060310R0FKEA
41	1	R78	RES., CHIP, 15.8k, 1%, 0603	VISHAY, CRCW060315K8FKEA
42	0	R82	RES., 1206	OPT
43	1	U1	IC, LTM4686EV#PBF	LINEAR TECH., LTM4686EV#PBF
44	1	U3	IC, EEPROM 2KBIT 400KHZ 8TSSOP	MICROCHIP, 24LC025-I/ST
45	1	U6	IC., LTC3204B-5	LINEAR TECH., LTC3204B-5#PBF
46	2	XJP1, XJP2	SHUNT	SAMTEC, 2SN-BK-G
47	4	(STAND-OFF)	STAND-OFF, NYLON 0.50" tall	KEystone, 8833 (SNAP ON)
48	1		FAB, PRINTED CIRCUIT BOARD	DEMO CIRCUIT 2722A
49	2		STENCIL TOP AND BOTTOM	STENCIL DC2722A

SCHEMATIC DIAGRAM

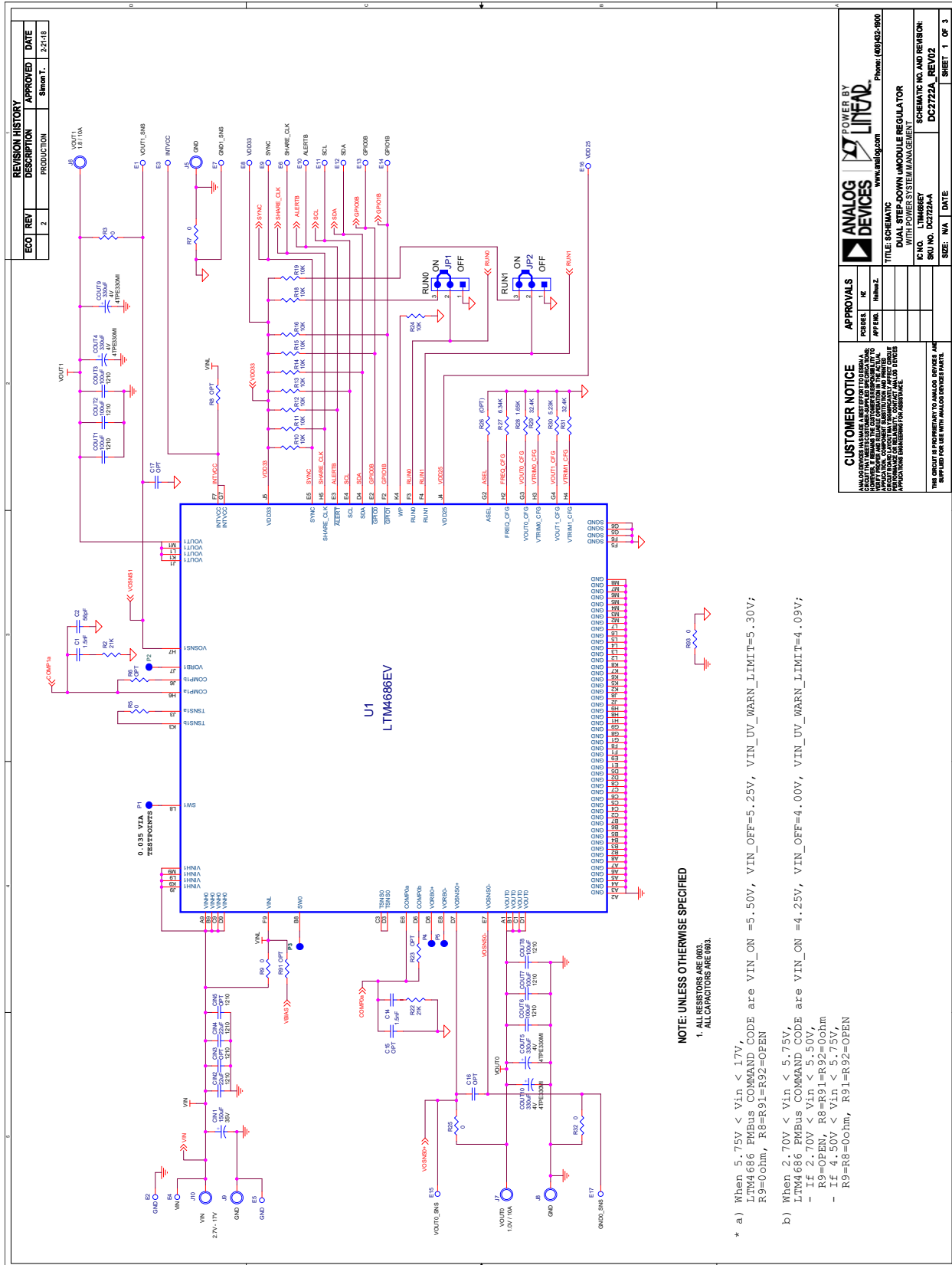

SCHEMATIC DIAGRAM

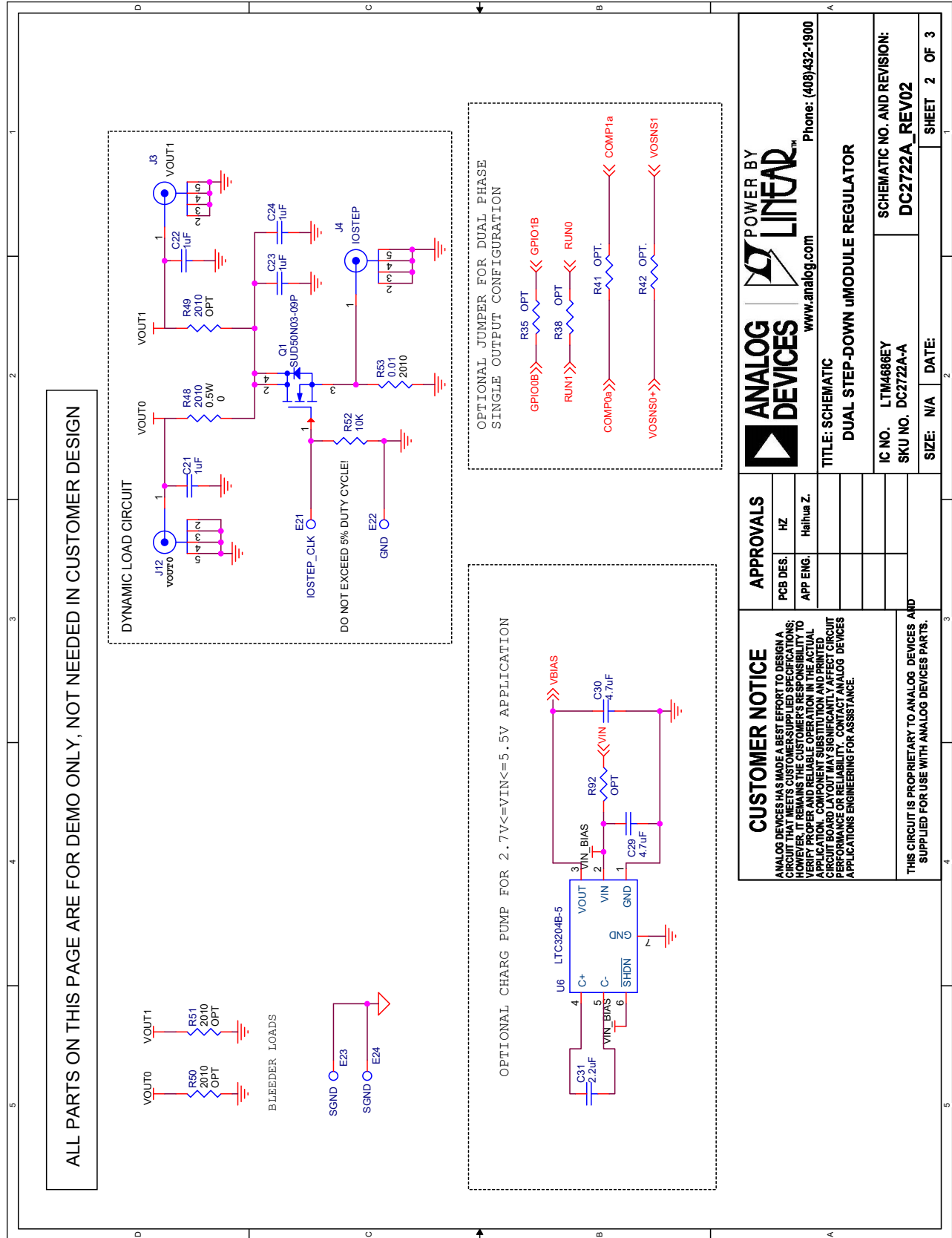

SCHEMATIC DIAGRAM

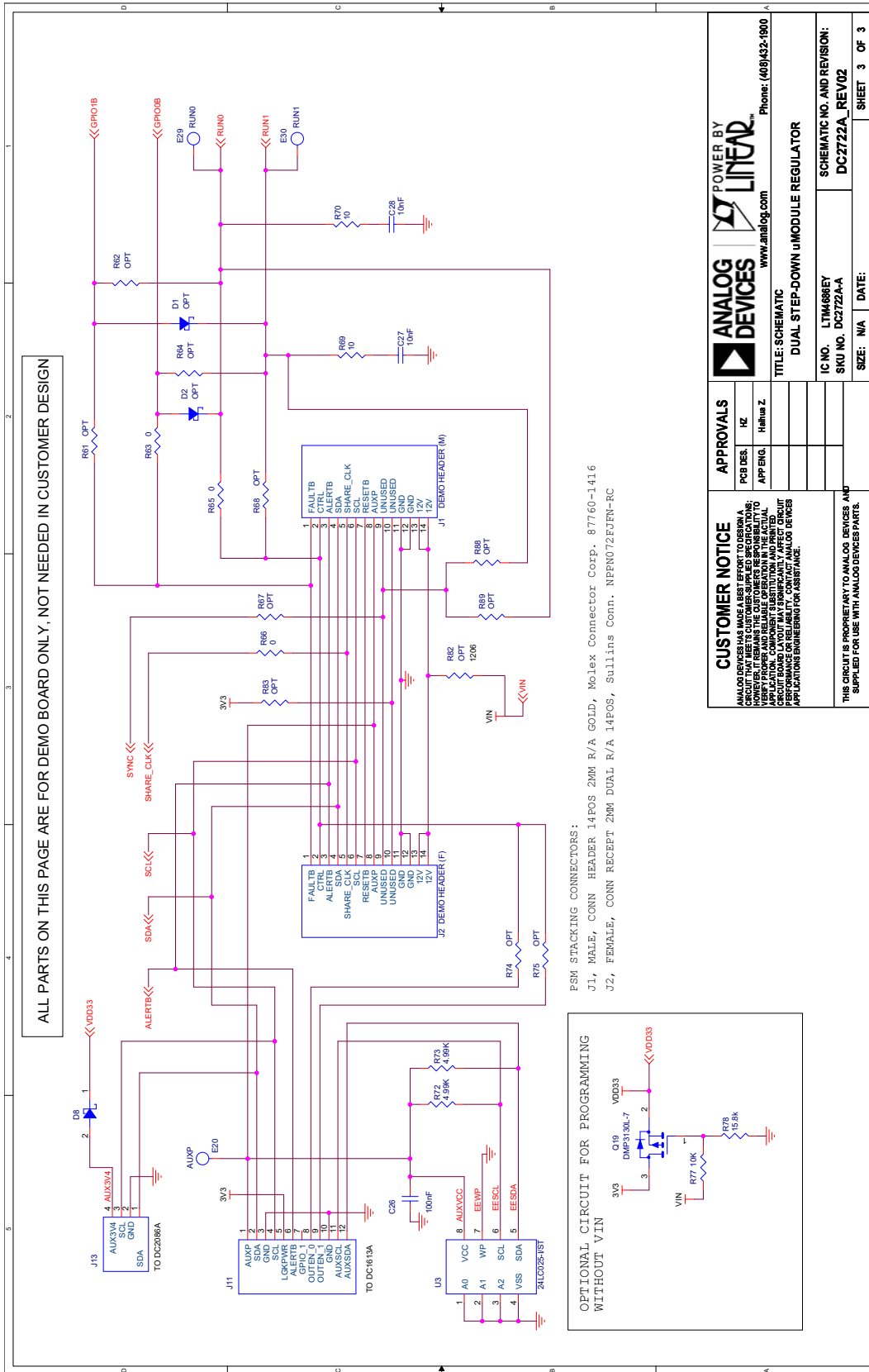



ESD Caution

ESD (electrostatic discharge) sensitive device. Charged devices and circuit boards can discharge without detection. Although this product features patented or proprietary protection circuitry, damage may occur on devices subjected to high energy ESD. Therefore, proper ESD precautions should be taken to avoid performance degradation or loss of functionality.

Legal Terms and Conditions

By using the evaluation board discussed herein (together with any tools, components documentation or support materials, the "Evaluation Board"), you are agreeing to be bound by the terms and conditions set forth below ("Agreement") unless you have purchased the Evaluation Board, in which case the Analog Devices Standard Terms and Conditions of Sale shall govern. Do not use the Evaluation Board until you have read and agreed to the Agreement. Your use of the Evaluation Board shall signify your acceptance of the Agreement. This Agreement is made by and between you ("Customer") and Analog Devices, Inc. ("ADI"), with its principal place of business at One Technology Way, Norwood, MA 02062, USA. Subject to the terms and conditions of the Agreement, ADI hereby grants to Customer a free, limited, personal, temporary, non-exclusive, non-sublicensable, non-transferable license to use the Evaluation Board FOR EVALUATION PURPOSES ONLY. Customer understands and agrees that the Evaluation Board is provided for the sole and exclusive purpose referenced above, and agrees not to use the Evaluation Board for any other purpose. Furthermore, the license granted is expressly made subject to the following additional limitations: Customer shall not (i) rent, lease, display, sell, transfer, assign, sublicense, or distribute the Evaluation Board; and (ii) permit any Third Party to access the Evaluation Board. As used herein, the term "Third Party" includes any entity other than ADI, Customer, their employees, affiliates and in-house consultants. The Evaluation Board is NOT sold to Customer; all rights not expressly granted herein, including ownership of the Evaluation Board, are reserved by ADI. CONFIDENTIALITY. This Agreement and the Evaluation Board shall all be considered the confidential and proprietary information of ADI. Customer may not disclose or transfer any portion of the Evaluation Board to any other party for any reason. Upon discontinuation of use of the Evaluation Board or termination of this Agreement, Customer agrees to promptly return the Evaluation Board to ADI. ADDITIONAL RESTRICTIONS. Customer may not disassemble, decompile or reverse engineer chips on the Evaluation Board. Customer shall inform ADI of any occurred damages or any modifications or alterations it makes to the Evaluation Board, including but not limited to soldering or any other activity that affects the material content of the Evaluation Board. Modifications to the Evaluation Board must comply with applicable law, including but not limited to the RoHS Directive. TERMINATION. ADI may terminate this Agreement at any time upon giving written notice to Customer. Customer agrees to return to ADI the Evaluation Board at that time. LIMITATION OF LIABILITY. THE EVALUATION BOARD PROVIDED HEREUNDER IS PROVIDED "AS IS" AND ADI MAKES NO WARRANTIES OR REPRESENTATIONS OF ANY KIND WITH RESPECT TO IT. ADI SPECIFICALLY DISCLAIMS ANY REPRESENTATIONS, ENDORSEMENTS, GUARANTEES, OR WARRANTIES, EXPRESS OR IMPLIED, RELATED TO THE EVALUATION BOARD INCLUDING, BUT NOT LIMITED TO, THE IMPLIED WARRANTY OF MERCHANTABILITY, TITLE, FITNESS FOR A PARTICULAR PURPOSE OR NON-INFRINGEMENT OF INTELLECTUAL PROPERTY RIGHTS. IN NO EVENT WILL ADI AND ITS LICENSORS BE LIABLE FOR ANY INCIDENTAL, SPECIAL, INDIRECT, OR CONSEQUENTIAL DAMAGES RESULTING FROM CUSTOMER'S POSSESSION OR USE OF THE EVALUATION BOARD, INCLUDING BUT NOT LIMITED TO LOST PROFITS, DELAY COSTS, LABOR COSTS OR LOSS OF GOODWILL. ADI'S TOTAL LIABILITY FROM ANY AND ALL CAUSES SHALL BE LIMITED TO THE AMOUNT OF ONE HUNDRED US DOLLARS (\$100.00). EXPORT. Customer agrees that it will not directly or indirectly export the Evaluation Board to another country, and that it will comply with all applicable United States federal laws and regulations relating to exports. GOVERNING LAW. This Agreement shall be governed by and construed in accordance with the substantive laws of the Commonwealth of Massachusetts (excluding conflict of law rules). Any legal action regarding this Agreement will be heard in the state or federal courts having jurisdiction in Suffolk County, Massachusetts, and Customer hereby submits to the personal jurisdiction and venue of such courts. The United Nations Convention on Contracts for the International Sale of Goods shall not apply to this Agreement and is expressly disclaimed.