

Click [here](#) to ask an associate for production status of specific part numbers.

20V, Low Input Bias-Current, Low-Noise, Dual Op Amplifier

MAX44242

General Description

The MAX44242 provides a combination of high voltage, low noise, low input bias current in a dual channel and features rail-to-rail at the output.

This dual amplifier operates over a wide supply voltage range from a single 2.7V to 20V supply or split $\pm 1.35V$ to $\pm 10V$ supplies and consumes only 1.2mA quiescent supply current per channel.

The MAX44242 is a unity-gain stable amplifier with a gain-bandwidth product of 10MHz. The device outputs drive up to 200pF load capacitor without any external isolation resistor compensation.

The MAX44242 is available in 8-pin SOT23 and $\mu\text{MAX}^{\text{®}}$ packages and is rated for operation over the -40°C to $+125^{\circ}\text{C}$ automotive temperature range.

Benefits and Features

- 2.7V to 20V Single Supply or $\pm 1.35V$ to $\pm 10V$ Dual Supplies
- 0.5pA (max) Input Bias Current
- $5\text{nV}/\sqrt{\text{Hz}}$ Input Voltage Noise
- 10MHz Bandwidth
- $8\text{V}/\mu\text{s}$ Slew Rate
- Rail-to-Rail Output
- Integrated EMI Filters
- 1.2mA Supply Current per Amplifier

[Ordering Information](#) appears at end of data sheet.

Applications

- Chemical Sensor Interface
- Photodiode Sensor Interface
- Medical Pulse Oximetry
- Industrial: Process and Control
- Precision Instrumentation

μMAX is a registered trademark of Maxim Integrated Products, Inc.

Typical Application Circuit

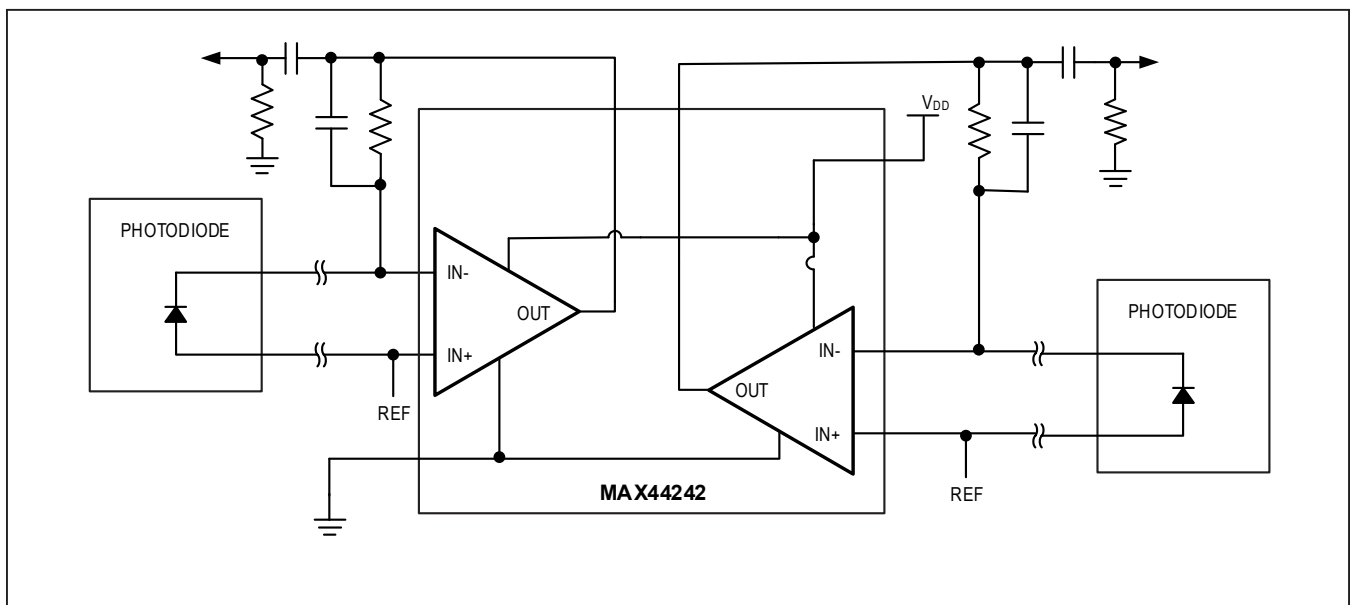

Absolute Maximum Ratings

Supply Voltage (V_{DD} to V_{SS})	-0.3V to +22V	Operating Temperature Range	-40°C to +125°C
All Other Pins	($V_{SS} - 0.3V$) to ($V_{DD} + 0.3V$)	Junction Temperature	+150°C
Short-Circuit Duration to V_{DD} or V_{SS}	1s	Storage Temperature Range	-65°C to +150°C
Continuous Input Current (Any Pins)	±20mA	Lead Temperature (soldering, 10s)	+300°C
Differential Input Voltage	±6V		
Continuous Power Dissipation ($T_A = +70°C$)			
8-Pin SOT23 (derate 5.1mW/°C above +70°C)	408.2mW		
8-Pin μ MAX (derate 4.5mW/°C above +70°C)	362mW		

Stresses beyond those listed under "Absolute Maximum Ratings" may cause permanent damage to the device. These are stress ratings only, and functional operation of the device at these or any other conditions beyond those indicated in the operational sections of the specifications is not implied. Exposure to absolute maximum rating conditions for extended periods may affect device reliability.

Package Thermal Characteristics (Note 1)

SOT23	Junction-to-Ambient Thermal Resistance (θ_{JA})	196°C/W	μ MAX	Junction-to-Ambient Thermal Resistance (θ_{JA})	221°C/W
	Junction-to-Case Thermal Resistance (θ_{JC})	70°C/W		Junction-to-Case Thermal Resistance (θ_{JC})	42°C/W

Note 1: Package thermal resistances were obtained using the method described in JEDEC specification JESD51-7, using a four-layer board. For detailed information on package thermal considerations, refer to www.maximintegrated.com/thermal-tutorial.

Electrical Characteristics

($V_{DD} = 10V$, $V_{SS} = 0V$, $V_{IN+} = V_{IN-} = V_{DD}/2$, $R_L = 10k\Omega$ to $V_{DD}/2$, $T_A = -40°C$ to $+125°C$, unless otherwise noted. Typical values are at $T_A = +25°C$.) (Note 2)

PARAMETER	SYMBOL	CONDITIONS	MIN	TYP	MAX	UNITS	
POWER SUPPLY							
Supply Voltage Range	V_{DD}	Guaranteed by PSRR	2.7		20	V	
Power-Supply Rejection Ratio	PSRR	$V_{DD} = 2.7V$ to $20V$, $V_{CM} = 0V$	$T_A = +25°C$	106	130	dB	
			$-40°C \leq T_A \leq +125°C$	100			
Quiescent Current Per Amplifier	I_{DD}	$R_{LOAD} = \text{infinity}$	$T_A = +25°C$		1.2	1.6	mA
			$-40°C \leq T_A \leq +125°C$			1.8	
Power-Up Time	t_{ON}			20		μ s	
DC CHARACTERISTICS							
Input Common-Mode Range	V_{CM}	Guaranteed by CMRR test	$V_{SS} - 0.05$		$V_{DD} - 1.5$	V	
Common-Mode Rejection Ratio	CMRR	$V_{CM} = V_{SS} - 0.05V$ to $V_{DD} - 1.5V$	$T_A = +25°C$	94	111	dB	
			$-40°C \leq T_A \leq +125°C$	90			
Input Offset Voltage	V_{OS}	$T_A = +25°C$		50	600	μ V	
		$-40°C \leq T_A \leq +125°C$			800		
Input Offset Voltage Drift (Note 3)	TC V_{OS}			0.25	2.5	μ V/°C	
Input Bias Current (Note 3)	I_B	$T_A = +25°C$		0.02	0.5	pA	
		$-40°C \leq T_A \leq +85°C$			10		
		$-40°C \leq T_A \leq +125°C$			50		

Electrical Characteristics (continued)

($V_{DD} = 10V$, $V_{SS} = 0V$, $V_{IN+} = V_{IN-} = V_{DD}/2$, $R_L = 10k\Omega$ to $V_{DD}/2$, $T_A = -40^\circ C$ to $+125^\circ C$, unless otherwise noted. Typical values are at $T_A = +25^\circ C$.) (Note 2)

PARAMETER	SYMBOL	CONDITIONS		MIN	TYP	MAX	UNITS
Input Offset Current (Note 3)	I_{OS}	$T_A = +25^\circ C$			0.04	0.5	pA
		$-40^\circ C \leq T_A \leq +85^\circ C$				10	
		$-40^\circ C \leq T_A \leq +125^\circ C$				25	
Open Loop Gain	A_{VOL}	$250mV \leq V_{OUT} \leq V_{DD} - 250mV$	$T_A = +25^\circ C$	134	145		dB
			$-40^\circ C \leq T_A \leq +125^\circ C$	129			
Input Resistance	R_{IN}	Differential			50		G Ω
		Common mode			200		
Output Short-Circuit Current		To V_{DD} or V_{SS}	Noncontinuous		95		mA
Output Voltage Low	V_{OL}	$V_{OUT} - V_{SS}$	$R_{LOAD} = 10k\Omega$ to $V_{DD}/2$			25	mV
			$R_{LOAD} = 2k\Omega$ to $V_{DD}/2$			85	
Output Voltage High	V_{OH}	$V_{DD} - V_{OUT}$	$R_{LOAD} = 10k\Omega$ to $V_{DD}/2$			37	mV
			$R_{LOAD} = 2k\Omega$ to $V_{DD}/2$			135	
AC CHARACTERISTICS							
Input Voltage-Noise Density	e_n	$f = 1kHz$			5		nV/ \sqrt{Hz}
Input Voltage Noise		$0.1Hz \leq f \leq 10Hz$			1.6		μV_{P-P}
Input Current-Noise Density	I_N	$f = 1kHz$			0.3		pA/ \sqrt{Hz}
Input Capacitance	C_{IN}				4		pF
Gain-Bandwidth Product	GBW				10		MHz
Phase Margin	PM	$C_{LOAD} = 20pF$			60		deg
Slew Rate	SR	$A_V = 1V/V$, $V_{OUT} = 2V_{P-P}$, 10% to 90%			8		V/ μs
Capacitive Loading	C_{LOAD}	No sustained oscillation, $A_V = 1V/V$			200		pF
Total Harmonic Distortion Plus Noise	THD+N	$V_{OUT} = 2V_{P-P}$, $A_V = +1V/V$	$f = 1kHz$		-124		dB
			$f = 20kHz$		-100		
EMI Rejection Ratio	EMIRR	$V_{RF_PEAK} = 100mV$	$f = 400MHz$		35		dB
			$f = 900MHz$		40		
			$f = 1800MHz$		50		
			$f = 2400MHz$		57		
Settling Time		To 0.01%, $V_{OUT} = 2V$ step, $A_V = -1V/V$			1		μs

Note 2: All devices are production tested at $T_A = +25^\circ C$. Specifications over temperature are guaranteed by design.

Note 3: Guaranteed by design.

Typical Operating Characteristics

($V_{DD} = 10V$, $V_{SS} = 0V$, outputs have $R_L = 10k\Omega$ to $V_{DD}/2$. $T_A = +25^\circ C$, unless otherwise specified.)

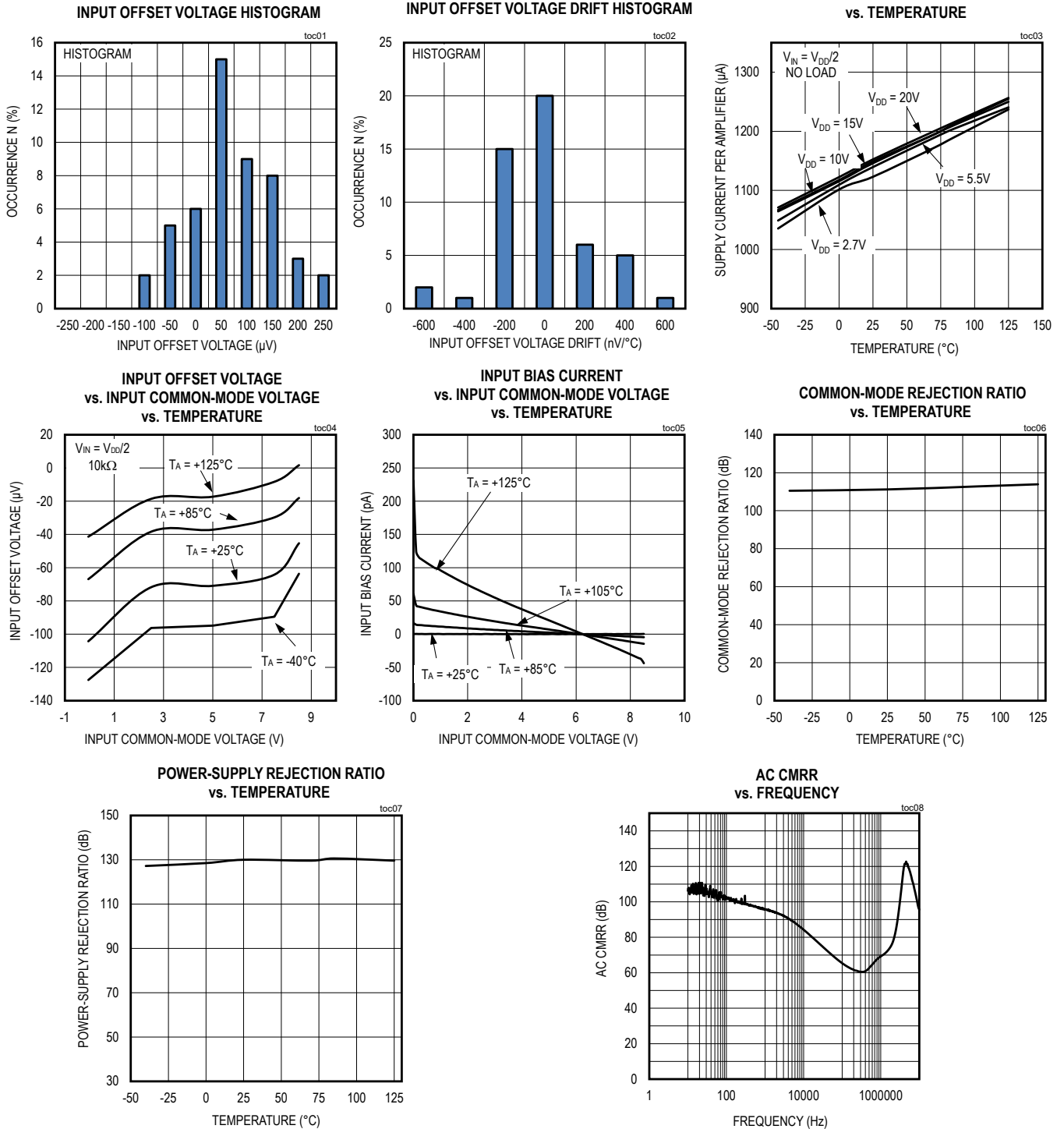

Typical Operating Characteristics (continued)

($V_{DD} = 10V$, $V_{SS} = 0V$, outputs have $R_L = 10k\Omega$ to $V_{DD}/2$. $T_A = +25^\circ C$, unless otherwise specified.)

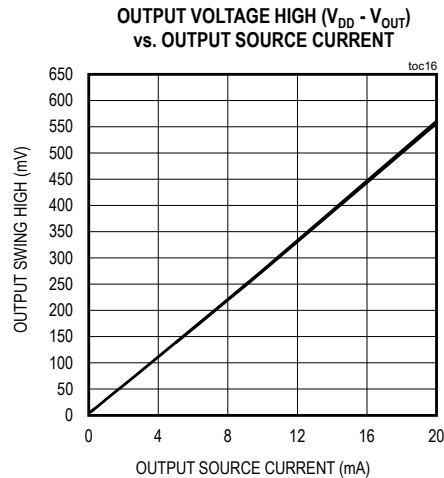
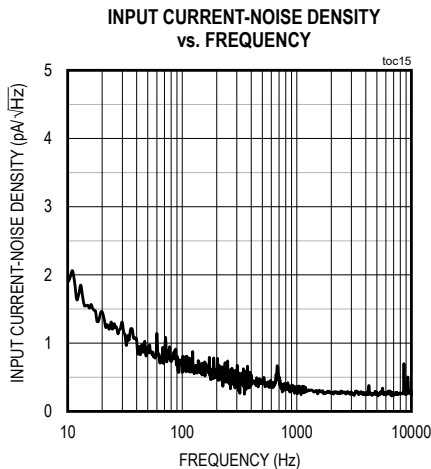
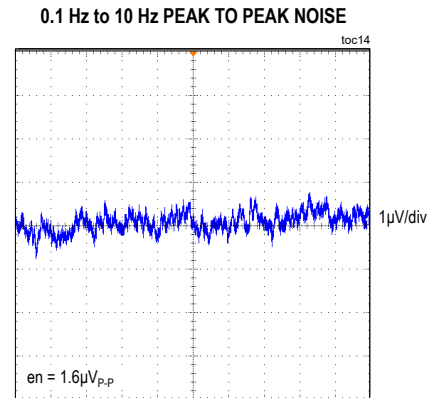
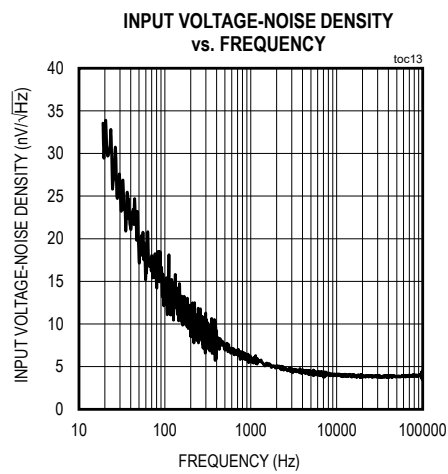
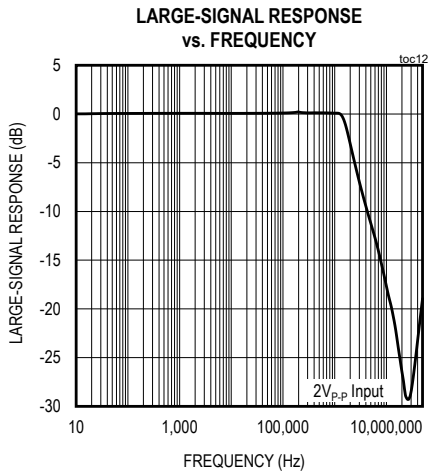
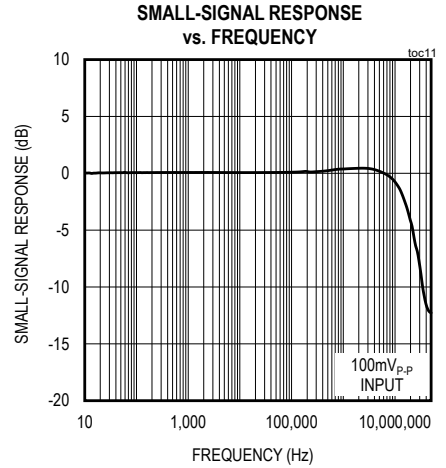
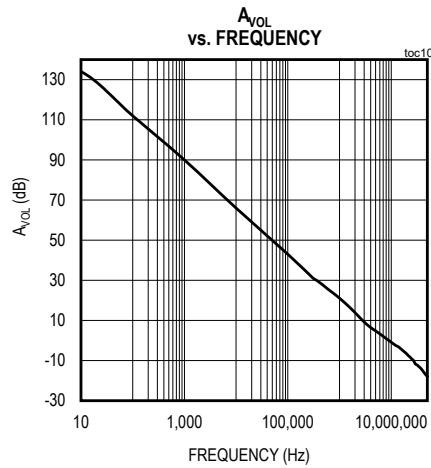
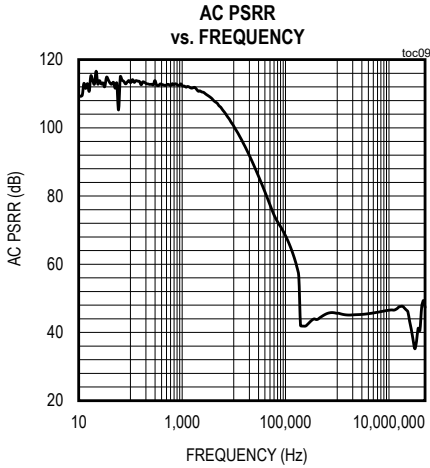

Typical Operating Characteristics (continued)

($V_{DD} = 10V$, $V_{SS} = 0V$, outputs have $R_L = 10k\Omega$ to $V_{DD}/2$. $T_A = +25^\circ C$, unless otherwise specified.)

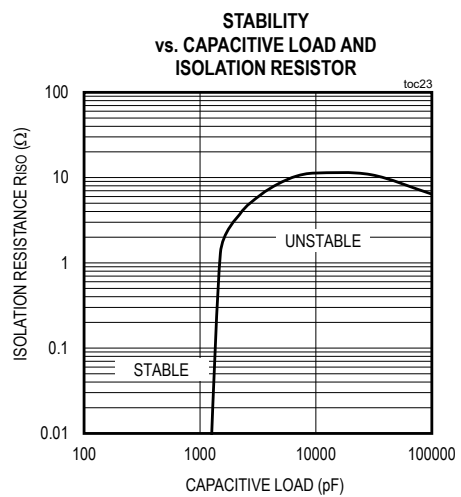
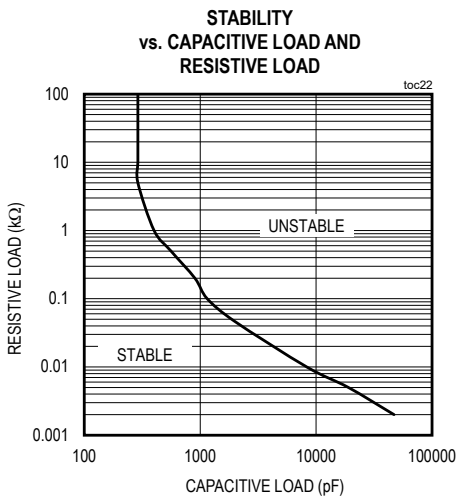
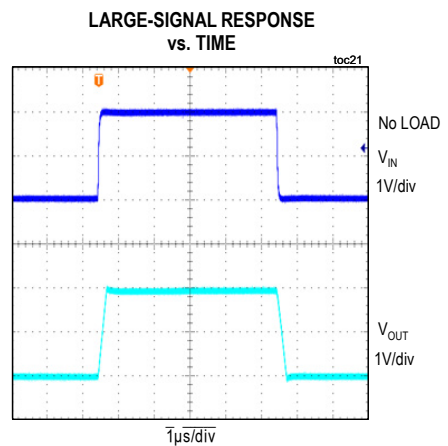
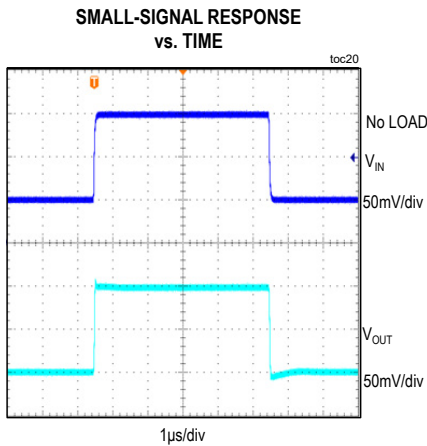
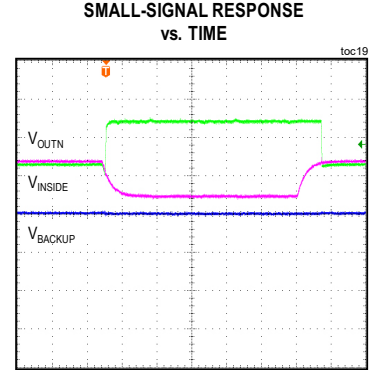
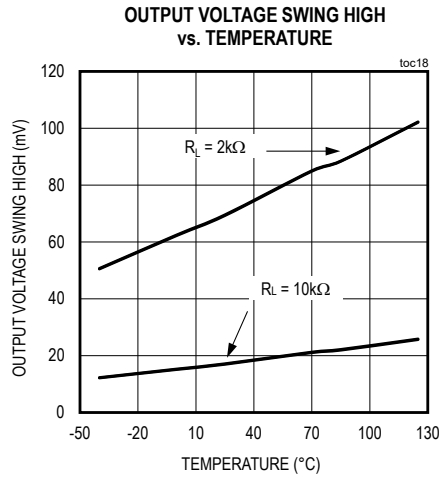
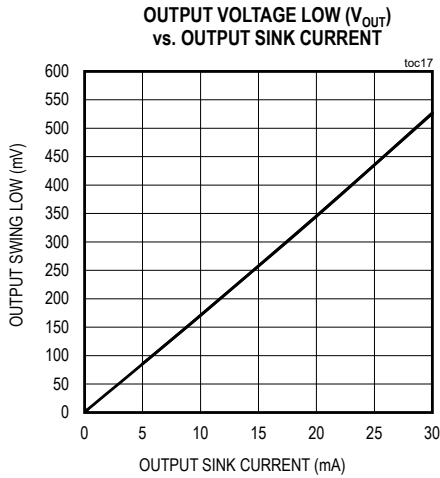

Typical Operating Characteristics (continued)

($V_{DD} = 10V$, $V_{SS} = 0V$, outputs have $R_L = 10k\Omega$ to $V_{DD}/2$. $T_A = +25^\circ C$, unless otherwise specified.)

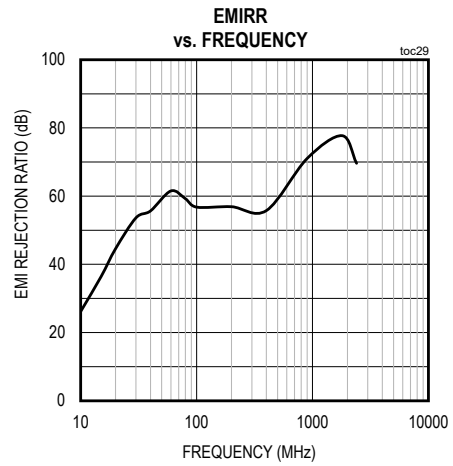
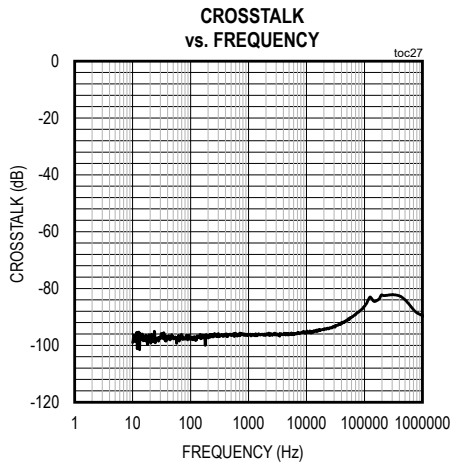
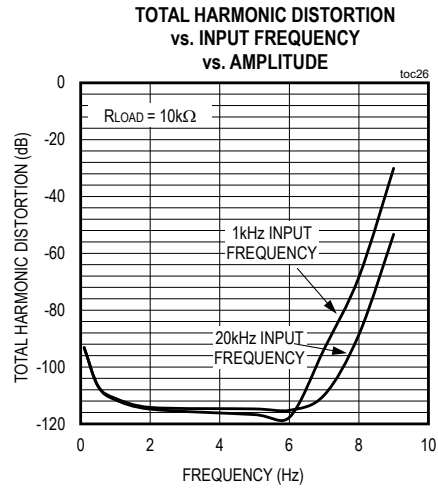
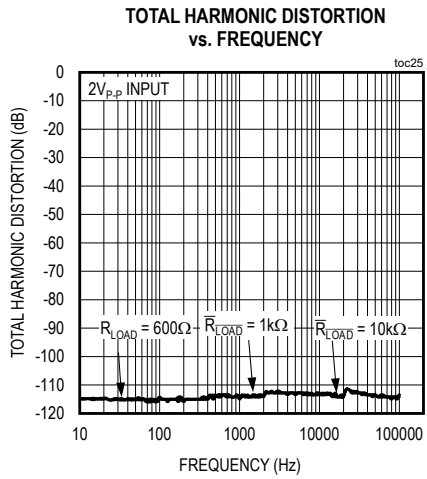

Pin Configuration

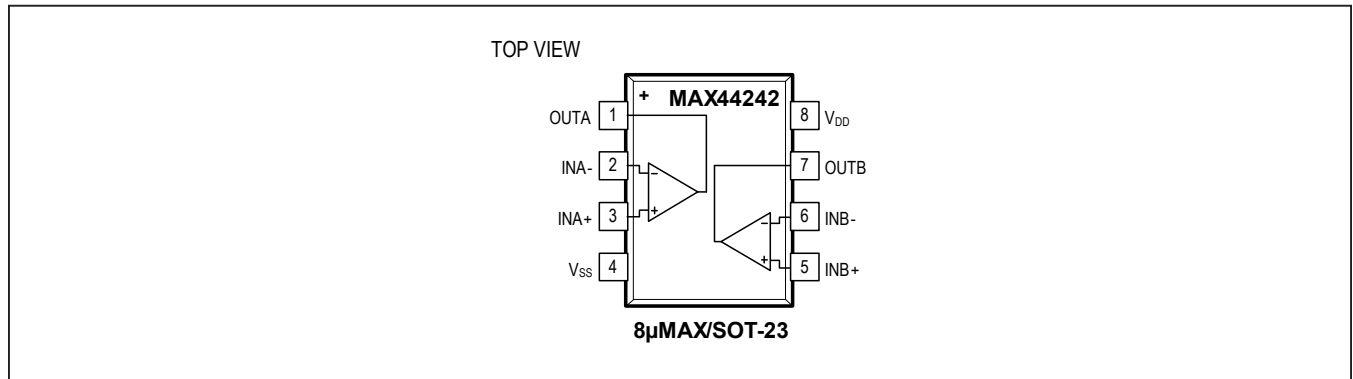

Pin Description

PIN	NAME	FUNCTION
1	OUTA	Channel A Output
2	INA-	Channel A Negative Input
3	INA+	Channel A Positive Input
4	V _{SS}	Negative Supply Voltage. Connect V _{SS} to ground if single supply is used.
5	INB+	Channel B Positive Input
6	INB-	Channel B Negative Input
7	OUTB	Channel B Output
8	V _{DD}	Positive Supply Voltage

Detailed Description

Combining high input impedance, low input bias current, wide bandwidth, and fast settling time, the MAX44242 is an ideal amplifier for driving precision analog-to-digital inputs and buffering digital-to-analog converter outputs.

Input Bias Current

The MAX44242 features a high-impedance CMOS input stage and a special ESD structure that allows low input bias current operation at low-input, common-mode voltages. Low input bias current is useful when interfacing with high-ohmic or capacitive sensors and is beneficial for designing transimpedance amplifiers for photodiode sensors. This makes the device ideal for ground-referenced medical and industrial sensor applications.

Integrated EMI Filter

Electromagnetic interference (EMI) noise occurs at higher frequency that results in malfunction or degradation of electrical equipment.

The MAX44242 has an input EMI filter to avoid the output from getting affected by radio frequency interference. The EMI filter, composed of passive devices, presents significant higher impedance to higher frequencies.

High Supply Voltage Range

The device features 1.2mA current consumption per channel and a voltage supply range from either 2.7V to 20V single supply or ±1.35V to ±10V split supply.

Typical Application Circuit

High-Impedance Sensor Application

High impedance sources like pH sensor, photodiodes in applications require negligible input leakage currents to the input transimpedance/buffer structure. The MAX44242 benefits with clean and precise signal conditioning due to its input structure.

The device interfaces to both current-output sensors (photodiodes) (Figure 1), and high-impedance voltage sources (piezoelectric sensors). For current output sensors, a transimpedance amplifier is the most noise-efficient method for converting the input signal to a voltage. High-value feedback resistors are commonly chosen to create large gains, while feedback capacitors help stabilize the amplifier by cancelling any poles introduced in the feedback loop by the highly capacitive sensor or cabling. A combination of low-current noise and low-voltage noise is important for these applications. Take care to calibrate out photodiode dark current if DC accuracy is important. The high bandwidth and slew rate also allow AC signal processing in certain medical photodiode sensor applications such as pulse-oximetry. For voltage-output sensors, a noninverting amplifier is typically used to buffer and/or

apply a small gain to the input voltage signal. Due to the extremely high impedance of the sensor output, a low input bias current with minimal temperature variation is very important for these applications.

Transimpedance Amplifier

As shown in Figure 2, the noninverting pin is biased at 2V with C2 added to bypass high-frequency noise. This bias voltage to reverse biases the photodiode D1 at 2V which is often enough to minimize the capacitance across the junction. Hence, the reverse current (I_R) produced by the photodiode as light photons are incident on it, a proportional voltage is produced at the output of the amplifier by the given relation:

$$V_{OUT} = I_R \times R1$$

The addition of C1 is to compensate for the instability caused due to the additional capacitance at the input (junction capacitance C_j and input capacitance of the op amp C_{IN}), which results in loss of phase margin. More information about stabilizing the transimpedance amplifier can be found in [Application Note 5129: Stabilize Your Transimpedance Amplifier](#).

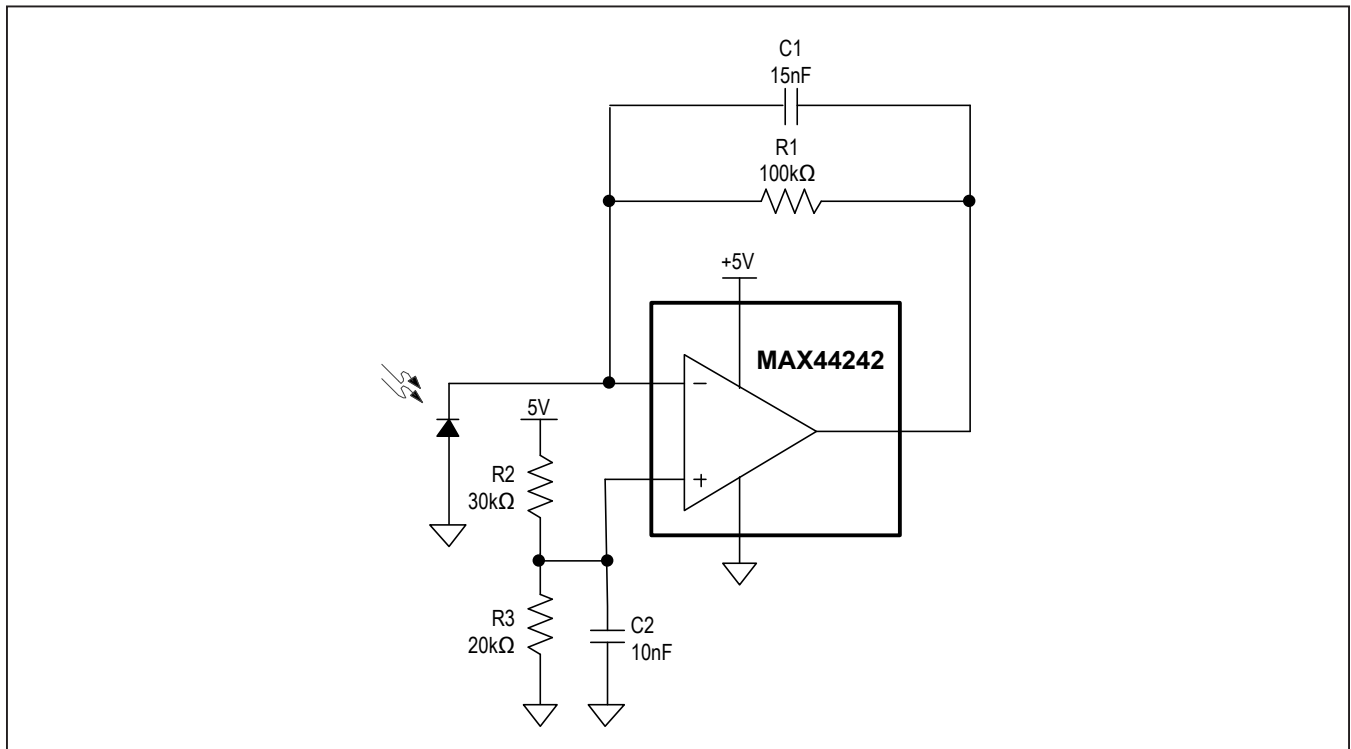

Figure 1. High-Impedance Source/Sensor Preamp Application

MAX44242

20V, Low Input Bias-Current,
Low-Noise, Dual Op Amplifier

Ordering Information

PART	TEMP RANGE	PIN-PACKAGE	TOP MARK
MAX44242AKA+	-40°C to +125°C	8 SOT23	AETK
MAX44242AUA+	-40°C to +125°C	8 μ MAX	—

+Denotes lead(Pb)-free/RoHS-compliant package.

Chip Information

PROCESS: BiCMOS

Package Information

For the latest package outline information and land patterns (footprints), go to www.maximintegrated.com/packages. Note that a "+", "#", or "-" in the package code indicates RoHS status only. Package drawings may show a different suffix character, but the drawing pertains to the package regardless of RoHS status.

PACKAGE TYPE	PACKAGE CODE	OUTLINE NO.	LAND PATTERN NO.
8 SOT23	K8+5	21-0078	90-0176
8 μ MAX	U8+1	21-0036	90-0092

Revision History

REVISION NUMBER	REVISION DATE	DESCRIPTION	PAGES CHANGED
0	12/13	Initial release	—
1	11/15	Updated <i>Pin Configuration</i> diagram	8
2	4/18	Updated <i>Typical Application Circuit</i>	1
3	3/21	Updated <i>Electrical Characteristics</i> table	3



Information furnished by Analog Devices is believed to be accurate and reliable. However, no responsibility is assumed by Analog Devices for its use, nor for any infringements of patents or other rights of third parties that may result from its use. Specifications subject to change without notice. No license is granted by implication or otherwise under any patent or patent rights of Analog Devices. Trademarks and registered trademarks are the property of their respective owners.