

μMODULE POWER PRODUCTS

Simplify Power

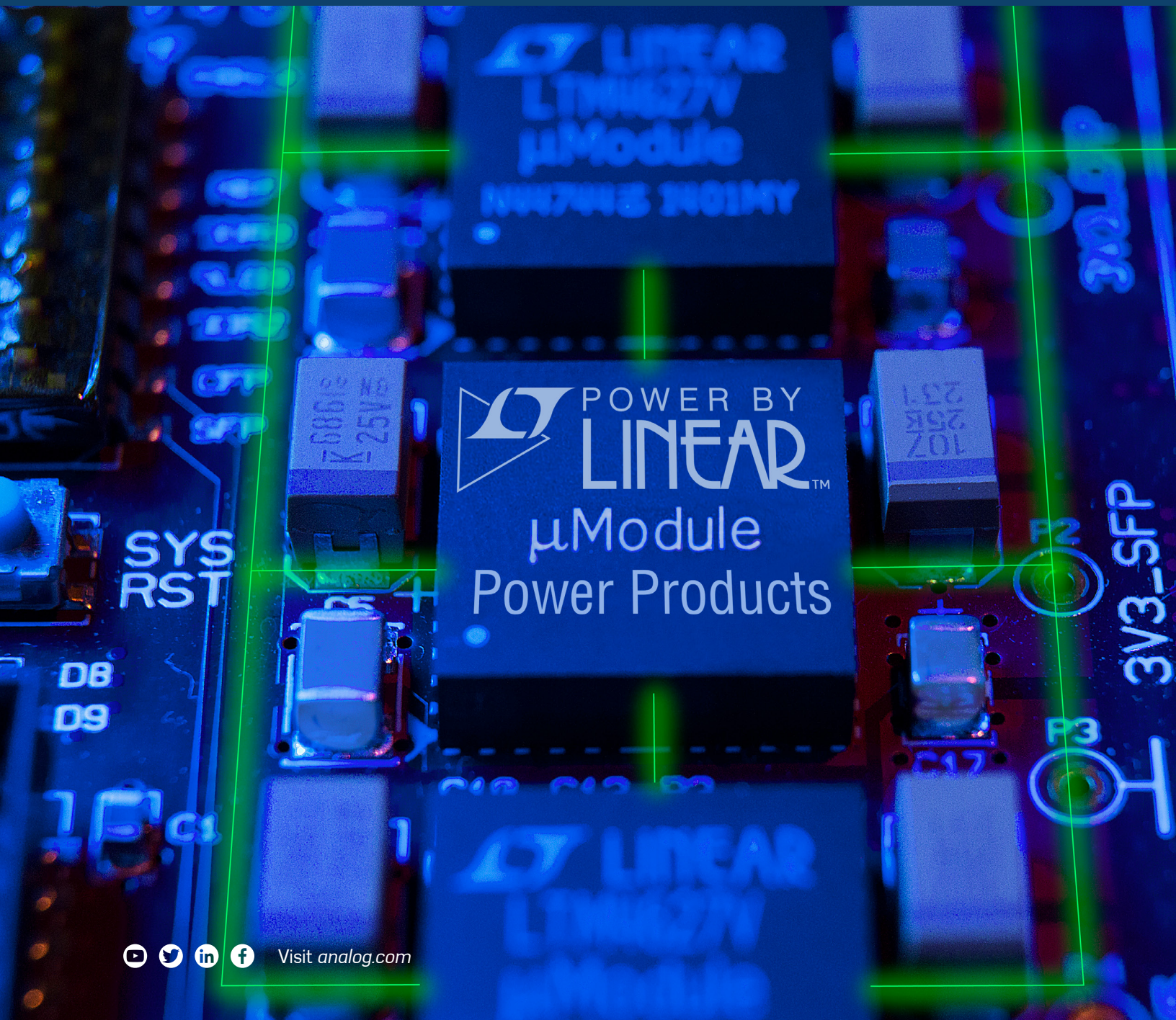

2 Contents

µModule Power Products.....	3
Simplify and Minimize Power Supply Circuits	4
Multiple Outputs.....	5
Adjustable Loop Compensation.....	6
Digital Power System Management.....	7
Scalability.....	7
µModule Ultrathin 1.82mm or 1.91mm Package	8
Low EMI.....	8
Inverting.....	9
Product Reliability.....	9
Packages	10
Package Technology.....	11
Selector Guide	12
Design and Application Support.....	26
FPGA and Processor Reference Designs	29
Design Tools	30

Search by Function



Step-Down
Page 13

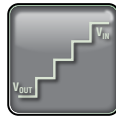

Step-Up
Page 15

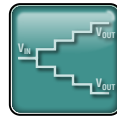

Step-Up & Down
Page 15



Isolated
Page 15



Digital Power System
Management
Page 15

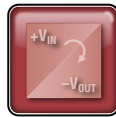

Inverting
Page 16



Battery Charger
Page 16

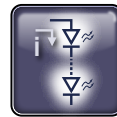

LED Driver
Page 17

Search by Feature

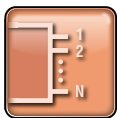

Multiple Output
Page 17

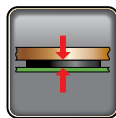

Ultrathin
Page 18



Low V_{IN} ($\leq 3V$)
Page 18

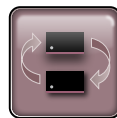

Pin Compatible
Page 19



Low EMI
Page 19



Wide Temperature
Page 20



SnPb BGA
Page 21



Adjustable Loop
Compensation
Page 22

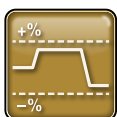

Margining
Page 23



Sequencing & Margining
Page 23



Precision Remote Sense
Page 25

Product Categories

POL Regulators (Step-Down, Step-Up & Down, Isolated, Inverting)

- ▶ Battery Chargers
- ▶ LED Drivers

Benefits

- ▶ Simplify Power Supply Circuit (Design, Verification and Manufacturing)
- ▶ Minimize Solution Size
- ▶ Improve Reliability

μModule power products are system-in-package solutions that integrate high-performance analog ICs, power switches and passive components. μModule Power Products optimally integrating these components, and provide high-performance in a small footprint.

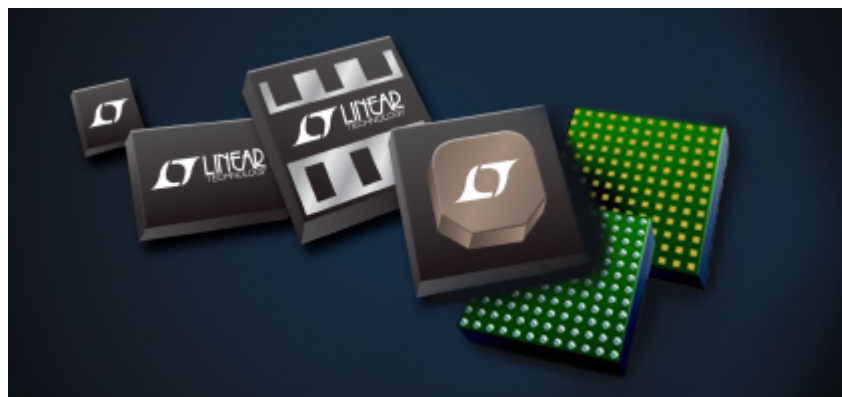
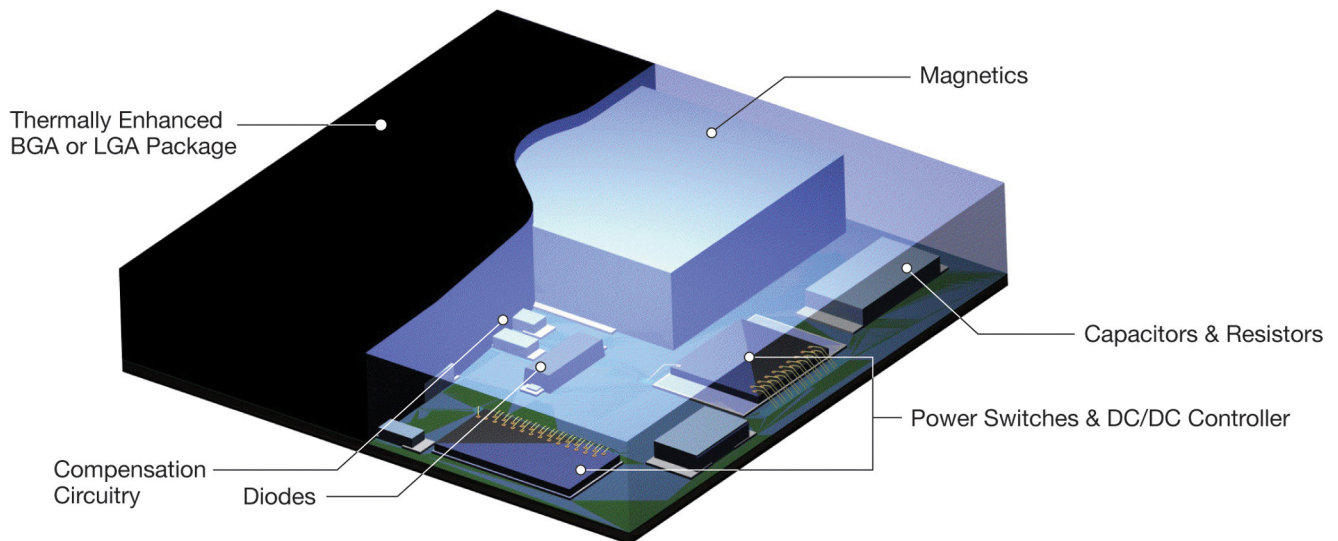

Various Advanced Package Technologies Have Been Introduced to Obtain High-Performance in a Small Package, Including Component on Package (CoP) and Ultrathin

4 Simplify and Minimize Power Supply Circuits

µModule Regulator Switching Regulator Switching Controller

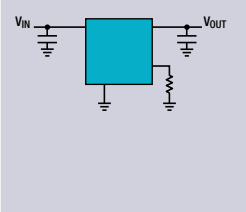
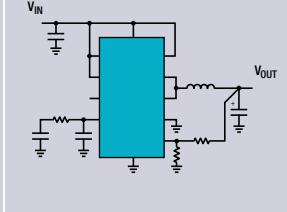
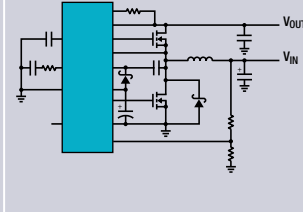
DC/DC Converter Comparison Table			
High Efficiency Region ¹ (V_{OUT} vs. V_{IN})	Wide	Wide	Wide
Component Count	Low	Moderate	High
Output Power	Low to High	Low to Mid	High
Design Effort	Low	Moderate	High
PCB Layout Effort	Low	Moderate	High
Schematic			

¹ Defined as supporting 85% efficiency or greater for this comparison

µModule Solution (LTM4622 Demo Circuit 2249B Dual 2.5A Output)

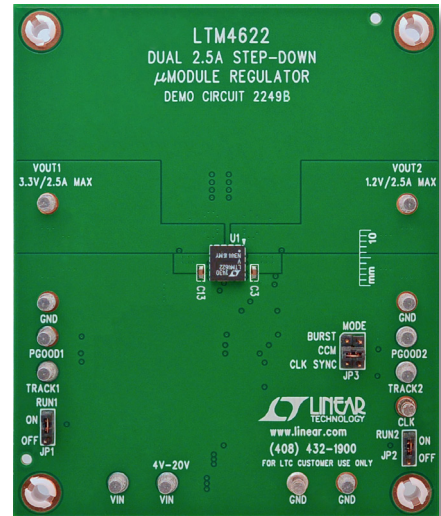
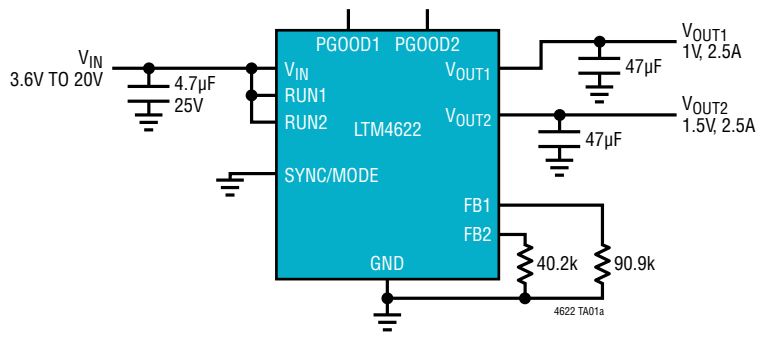

Comparable Switching Regulator Solution (LTC3633 Demo Circuit 1347A Dual 3A Output)

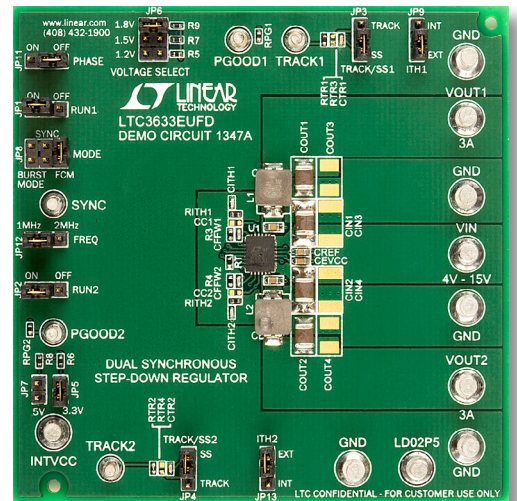
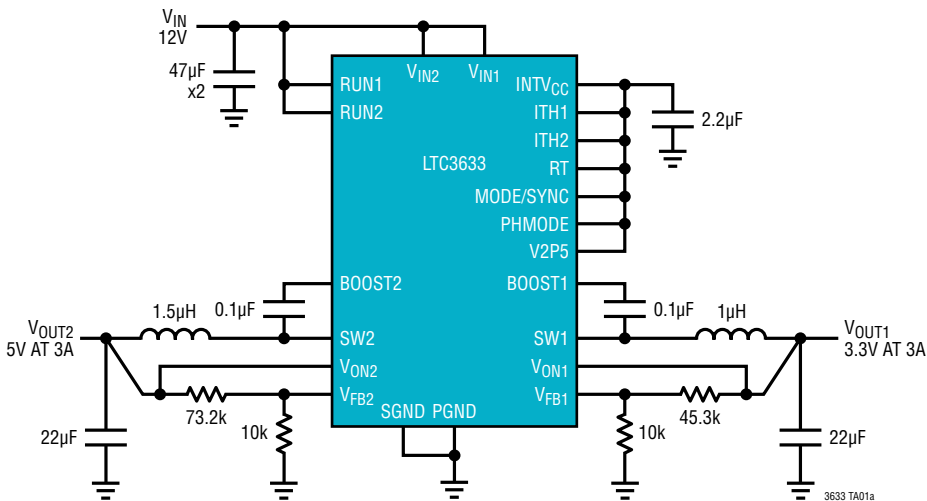

Multiple Outputs

See Page 17 for Selection Table

Example: LTM4644 Quad 4A Step-Down μ Module Regulator 9mm x 15mm Package

► Reduce solution size up to **73%**

LTC3605 x 4 (4A Monolithic Regulator): 900mm²

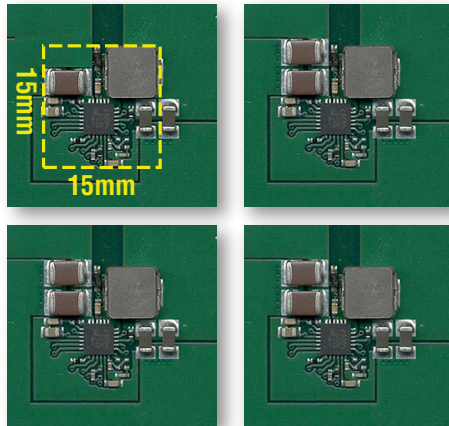

LTM4644 (4A Quad): 240mm²

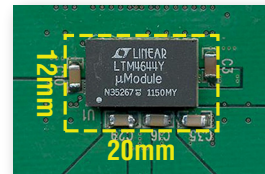

Comparison Between LTM4644 (Quad 4A) and Discrete Solution (LTM3605 x 4pcs). The LTM4644 is 73% Smaller

► Flexible Configuration

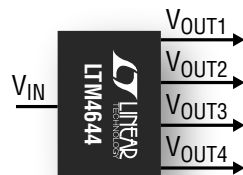

Quad Output
4A x 4

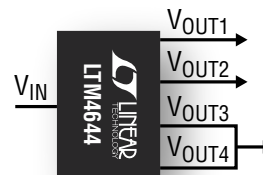

Triple Output
4A + 4A + 8A

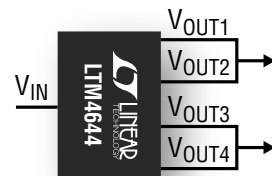

Dual Output
8A x 2

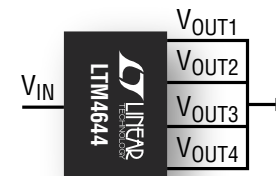

Single Output
16A x 1

LTM4644 (Quad 4A) Can Be Configured as Quad, Triple, Dual or Single Output

6 Adjustable Loop Compensation

See Page 22 for Selection Table

Example: LTM4650-1 Dual 25A or Single 50A Step-Down μ Module Regulator

- ▶ Meet tight voltage accuracy required by latest digital devices (e.g., $1V \pm 3\%$ including transients)
- ▶ Save board space and component cost by reducing the number of output capacitors up to **68%**

LTM4650
(Dual 25A or Single 50A Internal Compensation)
 $C_{OUT} = 38 \times 220\mu F$ Ceramic

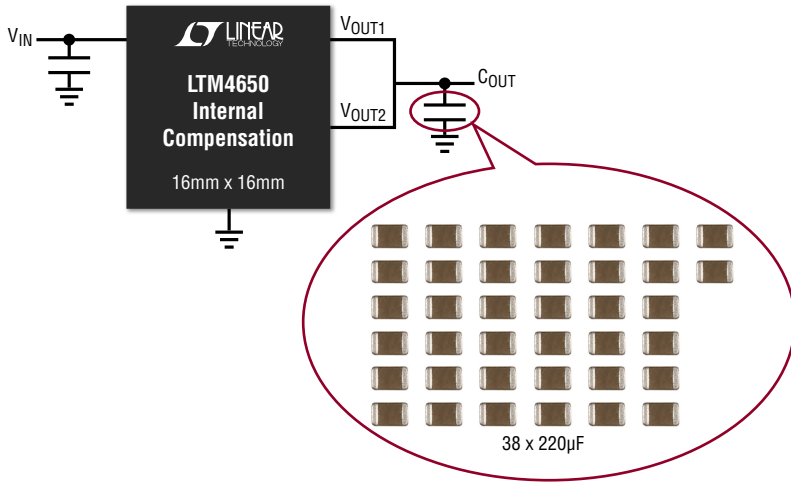

LTM4650-1
(Dual 25A or Single 50A External Compensation)
 $C_{OUT} = 12 \times 220\mu F$ Ceramic
 $R_{TH} = 5.4k\Omega$, $C_{TH} = 3.3nF$

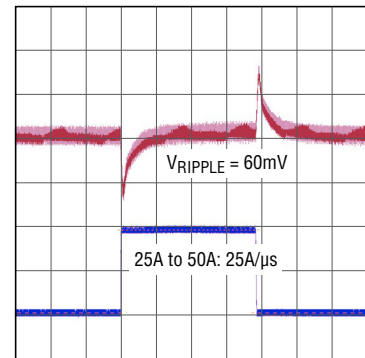
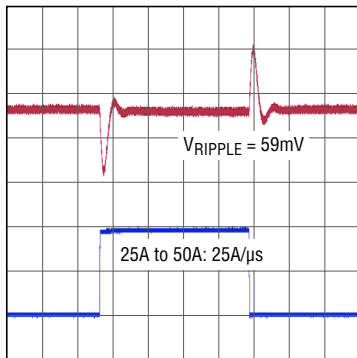
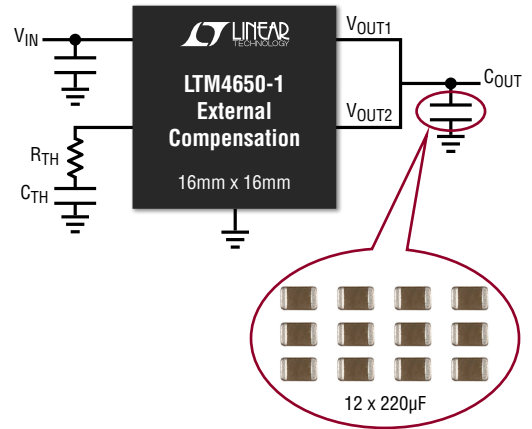

Load Transient Comparison Between LTM4650-1 (External Compensation) and LTM4650 (Internal Compensation).
 $12V_{IN}$ to $1V_{OUT}$. $f_{SW} = 500kHz$. 68% Capacitance Reduction with the LTM4650-1 to meet $1V \pm 30mV$ Under 25A Load Step.

See Page 15 for Selection Table

Function

Control and monitor the switching regulator through a PMBus/SMBus/I²C Bus digital interface. Control and monitor functions include:

- ▶ Output voltage monitoring, sequencing and margining
- ▶ Current monitor
- ▶ Temperature monitor
- ▶ Fault log

Benefits

- ▶ Easy design by LTpowerPlay GUI
- ▶ Increase system reliability
 - Tightly controlled voltage accuracy
 - Remote debugging
 - Fault reporting and logging
 - Fast reaction to faults

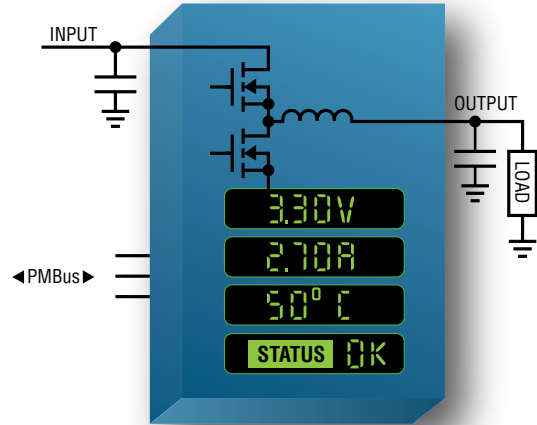

Scalability

Example: 386A Evaluation Board LTM4677 & LTM4650 x 7pcs.

- ▶ Increase output current easily

386A I_{OUT} with PSM Function. LTM4677 (36A) + 7pcs of LTM4650 (7 × 50A). The LTM4677 Controls and Monitors Output Voltage and Monitors Output Current Via a Digital Interface.

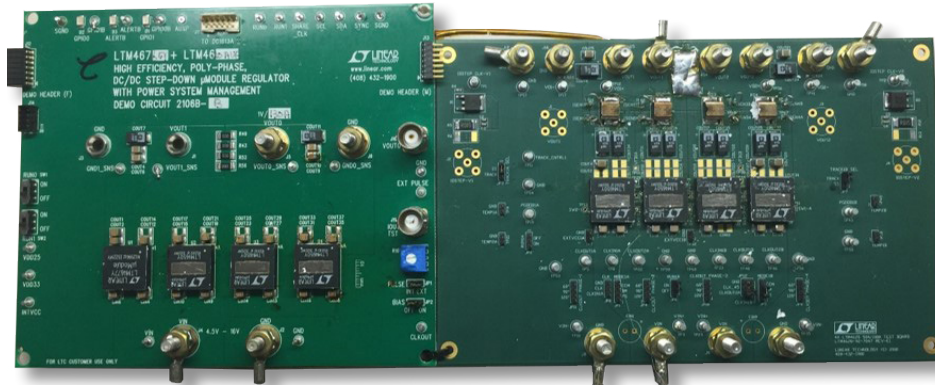

LTM4677 (36A) x 1pcs

LTM4650 (50A) x 7pcs = 350A

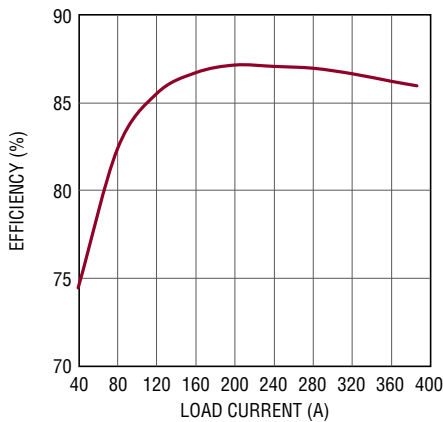

DC2481A-B + DC2455A-C. Efficiency vs Load Current.
 $V_{IN} = 12V, V_{OUT} = 1V, f_{SW} = 500kHz.$

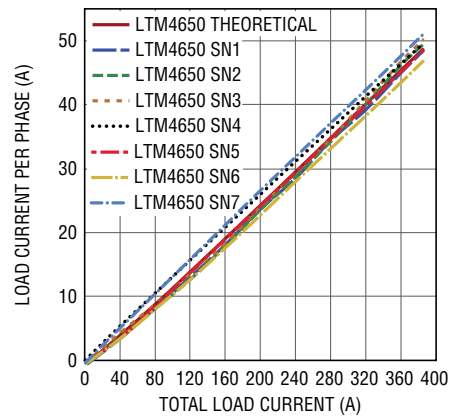

DC2481A-B + DC2455A-C. Current Sharing.

8 Ultrathin 1.82mm or 1.91mm Package Height

See Page 18 for Selection Table

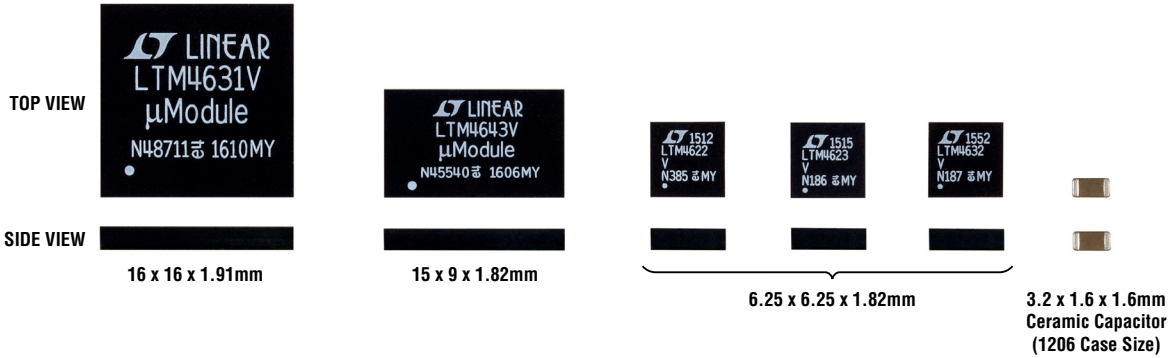

- ▶ Utilize backside of the PC board

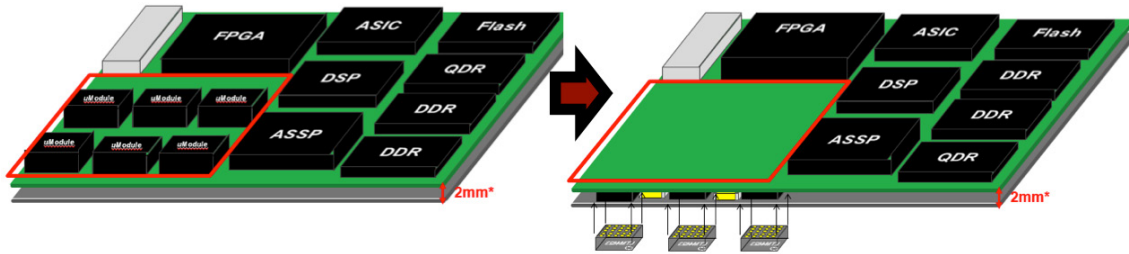

- ▶ Can be placed under the same heat sink with digital devices

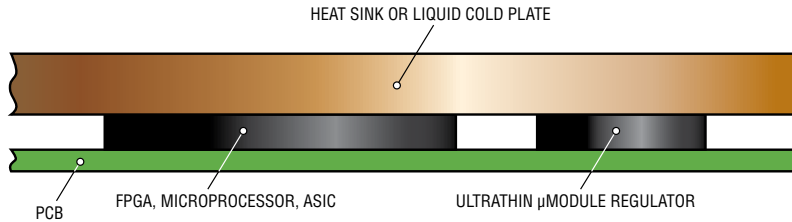

Low EMI

See Page 19 for Selection Table

- ▶ Comply with EMC standard (EN55022 Class B, CISPR22 Class B, CISPR25 Class 5)
- ▶ Minimize design risk and evaluation time

EN55022 Class B Compliant. 3rd Party Certification Online

- [LTM4606](#) - Ultralow EMI 28V_{IN}, 6A DC/DC μModule (Power Module) Regulator
- [LTM4612](#) - 36V_{IN}, 15V_{OUT}, 5A, DC/DC μModule (Power Module) Regulator
- [LTM4613](#) - 36V_{IN}, 15V_{OUT}, 8A, DC/DC μModule (Power Module) Regulator
- [LTM4623](#) - Ultrathin 20V_{IN}, 3A Step-Down DC/DC μModule (Power Module) Regulator
- [LTM4651](#) - 58V, 24W Inverting-Output DC/DC μModule Regulator
- [LTM8020](#) - 200mA, 36V DC/DC μModule (Power Module) Regulator
- [LTM8021](#) - 36V_{IN}, 500mA Step-Down DC/DC μModule (Power Module)
- [LTM8031](#) - Ultralow Noise EMC 36V, 1A DC/DC μModule (Power Module) Regulator
- [LTM8032](#) - EN55022B Compliant 36V, 2A DC/DC μModule (Power Module) Regulator
- [LTM8033](#) - Ultralow Noise EMC 36V_{IN}, 3A DC/DC μModule (Power Module) Regulator

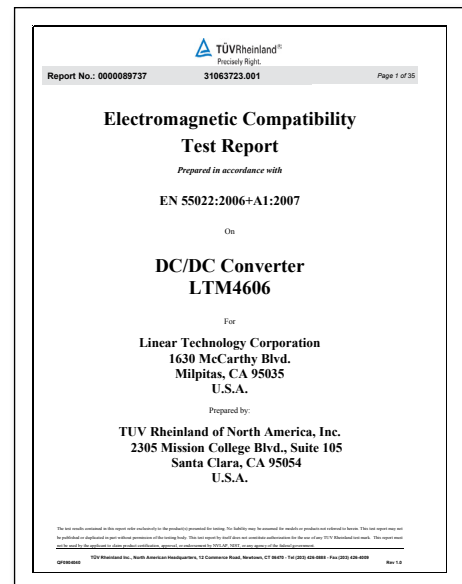

Sample EN55022 Class B Compliant Certification

See Page 16 for Selection Table

Example: LTM4651 58V, 24W Inverting Output μ Module Regulator.

- ▶ Designed and specified as inverting regulator
- ▶ Does not require external components for level-shift circuitry

LTM4651 58V, 25W Inverting Output μ Module Regulator

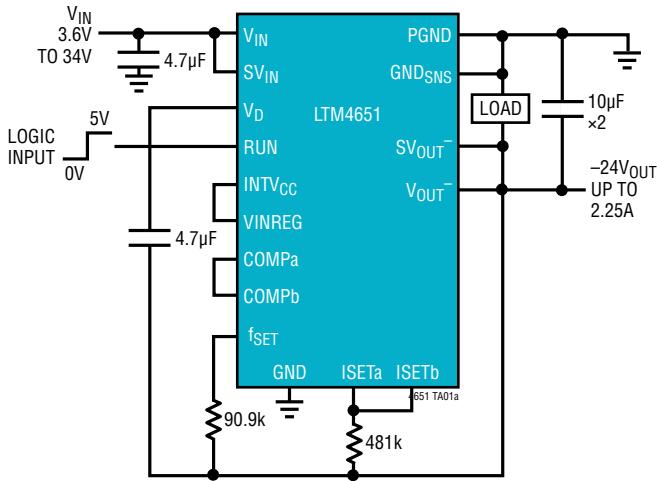

LTM4651 Can Be Driven by Typical Logic Level Signals.
Does Not Require Level-Shift Circuitry

LTM8027 60V, 5A Step-Down μ Module Regulator Configured as an Inverter

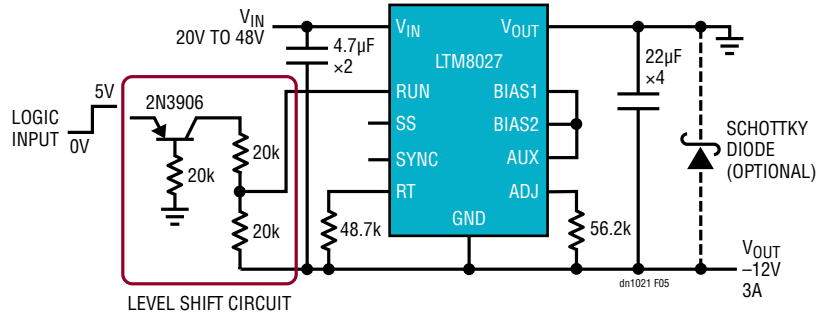

LTM8027 Can Be Easily Configured to Generate Negative Output Voltages. Run Voltage Must Be Level-Shifted.

Product Reliability

	Condition	LTM46xx	LTM80xx	Total	Unit
Operating Life	125°C	5,071	2,645	7,716	K Device Hours
High Accelerated Stress Test	130°C 85%RH	15,082	10,943	26,025	K Device Hours
Temp Cycle	-65°C to 150°C	25,046	16,191	41,237	K Device Cycles
Thermal Shock	-65°C to 150°C	16,439	15,477	31,916	K Device Cycles
Power Cycle	50°C to 100°C	22,175	1,800	23,975	K Device Cycles
High Temperature Bake	150°C	43,605	8,355	51,960	K Device Hours
Board Mount Temp Cycle	-40°C to 125°C	2,118	1,067	3,185	K Device Cycles
Mechanical Shock	JESD22-B104 Condition B, Peak 1500G	165	235	400	pcs
Vibration Variable Frequency	JESD22-B103 Condition A, Peak 20G	228	349	577	pcs

For reliability data visit;

www.linear.com/designtools/packaging/umodule.php

10 Packages



Package Height	Package Type	Part Number Example	Feature
7.07mm	BGA (CoP)	LTM4636	40A



5.74mm	BGA (CoP)	LTM4678	Dual 25A Power System Management
--------	-----------	---------	----------------------------------



5.01mm	BGA	LTM4650, LTM4650-1	Dual 25A
--------	-----	--------------------	----------



5.01mm	BGA	LTM4677	Dual 18A Power System Management
4.41mm	LGA	LTM4630, LTM4630A, LTM4630-1	Dual 18A
		LTM4676, LTM4676A	Dual 13A Power System Management
1.91mm	LGA	LTM4631	Dual 10A Ultrathin



4.92mm	BGA	LTM4627	20A
		LTM8055, LTM8056	Step-Up & Down
3.42mm	BGA	LTM4601	12A
		LTM8001	Five Outputs
4.32mm	LGA	LTM4627	20A
		LTM8027	4A, 60V Input
2.82mm	LGA	LTM4601	12A
		LTM4607	Step-Up & Down



5.01mm	LGA	LTM4620, LTM4620A	Dual 13A
4.41mm	BGA	LTM4620, LTM4620A	Dual 13A



5.01mm	BGA	LTM4633	Triple 10A
		LTM4634	Triple 5A x 2, 4A, High Voltage



4.92mm	BGA	LTM4637	20A
4.32mm	LGA	LTM4637	20A



4.92mm	BGA	LTM8064	58V _{IN} , 6A CvCC
3.57mm	BGA	LTM4675	Dual 5A Power System Management
1.82mm	LGA	LTM4686	Dual 5A Power System Management



Package Height	Package Type	Part Number Example	Feature
5.78mm	BGA (CoP)	LTM4662	Dual 15A



5.01mm	BGA	LTM4646	Dual 10A
4.92mm	BGA	LTM8033	3A, Ultralow Noise
3.42mm	BGA	LTM8054	Step-Up & Down
4.32mm	LGA	LTM8033	3A, Ultralow Noise
2.82mm	LGA	LTM8052	Constant Voltage, Constant Current



5.01mm	BGA	LTM4647	30A
		LTM4644	Quad 4A
4.92mm	BGA	LTM4649	10A
4.32mm	BGA	LTM4618	Dual 8A
3.42mm	BGA	LTM4609	Step Up & Down
		LTM8032	2A, Ultralow Noise
2.82mm	LGA	LTM8031	1A, 36V _{IN} , Low Noise
2.42mm	BGA	LTM8049	Dual SEPIC and/or Inverting
1.82mm	LGA	LTM4643	Quad 3A, Ultrathin



4.92mm	BGA	LTM4642	Dual 4A
		LTM8067, LTM8068	Isolated, UL60950 Recognized
3.42mm	BGA	LTM8023	2A, 36V _{IN}
2.82mm	LGA	LTM8023	2A, 36V _{IN}



4.92mm	BGA	LTM8045	Inverting or SEPIC
3.42mm	BGA	LTM8029	Single 600mA, 36V _{IN}
2.82mm	LGA	LTM8021	Single 500mA, 36V _{IN}



3.32mm	BGA	LTM8053, LTM8003	40V, 3.5A
		LTM8073	60V, 3A



5.01mm	BGA	LTM4625	5A
2.32mm	BGA	LTM8065	2.5A, 40V
2.42mm	BGA	LTM4622	Dual 2.5A, Ultrathin
1.82mm	LGA	LTM4622	Dual 2.5A, Ultrathin



2.22mm	BGA	LTM8065	2A, 40V
--------	-----	---------	---------

Standard BGA and LGA Packages

µModule power products are provided in BGA and LGA packages. The pad assignment of the package is uniform for easy PCB design. Both RoHS compliant and SnPb terminal finishes are available in the BGA package.

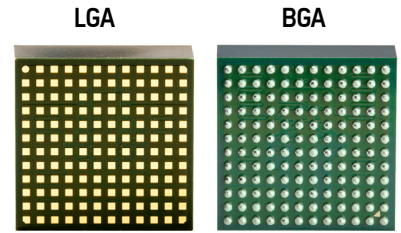

Uniform pad layout: simplify PC board design and assembly

Ultrathin Package

The package height of the ultrathin µModule product family is 1.82mm or 1.91mm (LGA). This thin package allows placement on the backside of the PCB or under a common heat sink with digital devices such as FPGAs, ASICs and processors. These parts are also offered in BGA packages (0.6mm taller than LGA).

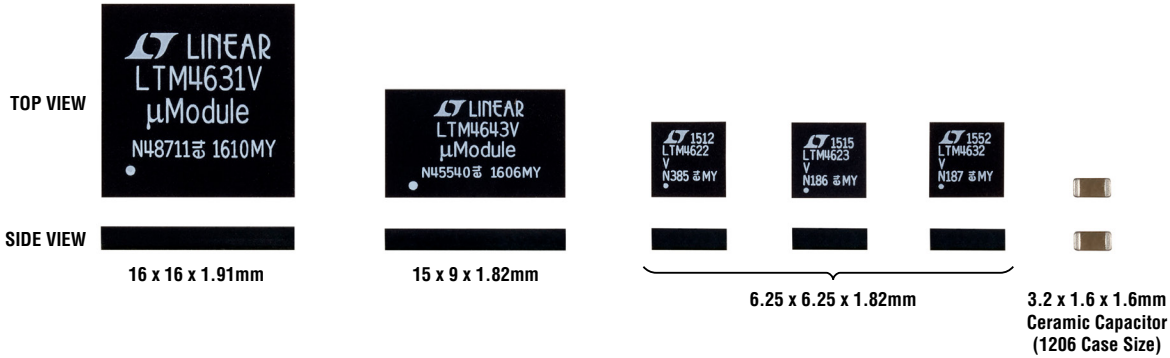

1.82mm or 1.91mm package height: Ideal for mounting on backside of PCB and under heat sink

Integrated Heat Sink

Integrated heat sink technology provides better thermal performance and high power density.

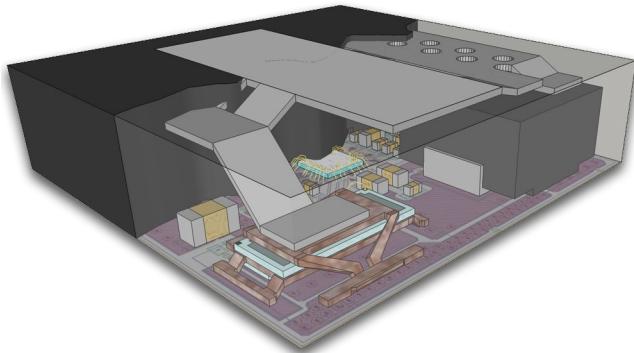

Integrated Heat Sink: For faster and more efficient heat removal from the top of the package





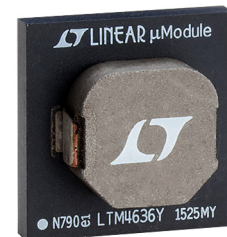
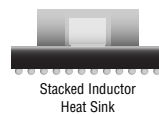
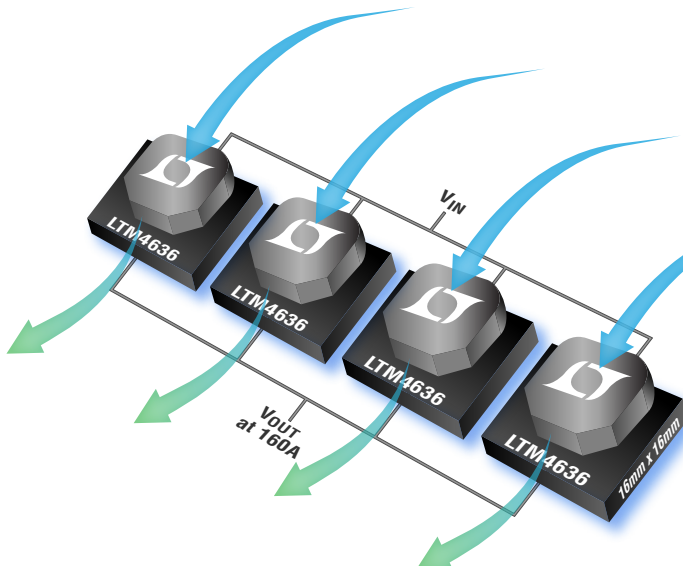















Component on Package (CoP)

The inductor placed on the top of the package acts as a heat sink. Direct air flow across the inductor cools the device very effectively.



Inductor as Heat Sink:
For faster and more efficient heat removal from the top of the package

12 Selector Guide

FEATURE	FUNCTION								
	 Step-Down	 Step-Up	 Step-Up & Down	 Isolated	 Inverting	 Digital Power System Management	 Battery Charger	 LED Driver	
 Pin Compatible	Page 19	–	Page 19	–	–	–	–	–	
 SMPb BGA	Pages 21 & 22	–	Page 21	Page 21	Page 22	–	–	–	
 Voltage Margining	Page 23 & 24	–	–	–	–	–	–	–	
 Output Sequencing	Pages 23 & 24	–	–	–	–	–	–	–	
 Precision Remote Sense	Page 25	–	–	–	–	–	–	–	
 Wide Temperature	Page 20	–	Page 20	Page 20	–	–	–	–	
 Multiple Output	Page 17	–	–	Page 15	–	Page 15	–	–	
 Parallelable	Pages 13 & 14	Page 15	Page 15	–	Page 16	Page 15	Page 16	–	
 Synchronizable	Pages 13 & 14	Page 15	Page 15	–	Page 16	Page 15	–	Page 17	
 Current Limit	Pages 13 & 14	–	–	–	–	–	–	–	
 Low EMI	Page 19	–	–	–	Pages 16 & 19	–	–	–	
 Ultrathin	Page 18	–	–	–	–	–	–	–	



Step-Down

Output Channels	Input Voltage (V)		Output Voltage (V)		Output Current (A)	Sync Range (MHz)	Parallellable** Outputs (Total I _{OUT})	Adjustable Current Limit	Package Dimensions (mm)	Package	Part Number
	Min	Max	Min	Max							
1	4	36	1.2	5	0.2	–	–	–	6.25 × 6.25 × 2.32	LGA	LTM8020
1	3	36	0.8	5	0.5	–	–	–	6.25 × 11.25 × 2.82	LGA	LTM8021
1	4.5	36	1.2	18	0.6	–	–	–	6.25 × 11.25 × 3.42	BGA	LTM8029
1	3.6	36	0.8	10	1	0.25 to 2.0	×2 (2A)	–	9 × 11.25 × 2.82	LGA	LTM8022
1	3.6	36	0.8	10	1	0.25 to 2.0	×2 (2A)	–	9 × 15 × 2.82	LGA	LTM8031
5	6	36	0	24	1	0.2 to 1.0	×2 (10A)	√	15 × 15 × 3.42	BGA	LTM8001
1	3.6	36	0.8	10	2	0.25 to 2.0	×2 (4A)	–	9 × 11.25 × 2.82 9 × 11.25 × 3.42	LGA BGA	LTM8023
1	3.6	36	0.8	10	2	0.25 to 2.0	×2 (4A)	–	9 × 15 × 2.82 9 × 15 × 3.42	LGA BGA	LTM8032
1	3.6	58	0.8	24	2	0.25 to 2.0	×2 (4A)	–	9 × 15 × 4.92	BGA	LTM8050
2	3.6	20	1.5	12	2	0.56 to 4	×2 (8A)	–	6.25 × 6.25 × 1.82 6.25 × 6.25 × 2.42	LGA BGA	LTM4622A
1	3.2	40	0.8	15	2 (Continuous) 2.5 (Peak)	0.2 to 2.2	–	–	4 × 6.25 × 2.22	BGA	LTM8063
2	3.6*	20	0.6	5.5	2.5	0.56 to 4	×2 (10A)	–	6.25 × 6.25 × 1.82 6.25 × 6.25 × 2.42	LGA BGA	LTM4622
1	3.4	40	0.97	18	2.5 (Continuous) 3.5 (Peak)	0.2 to 3	–	–	6.25 × 6.25 × 2.32	BGA	LTM8065
1	3.6	36	0.8	24	3	0.25 to 2.0	×2 (6A)	–	9 × 15 × 4.32 9 × 15 × 4.92	LGA BGA	LTM8025
1	3.6	36	0.8	24	3	0.25 to 2.0	×2 (6A)	–	11.25 × 15 × 4.32 11.25 × 15 × 4.92	LGA BGA	LTM8033
1	4*	20	0.6	5.5	3	0.56 to 4	×2 (6A)	–	6.25 × 6.25 × 1.82 6.25 × 6.25 × 2.42	LGA	LTM4623
1	3.4	60	0.8	15	3 (Continuous) 5 (Peak)	0.2 to 3	× 2 (6A)	–	6.25 × 9 × 3.32	BGA	LTM8073
3	3.6*	15	0.6	2.5	3	0.56 to 4	×2 (12A)	–	6.25 × 6.25 × 1.82 6.25 × 6.25 × 2.42	LGA BGA	LTM4632
4	4*	20	0.6	3.3	3	0.85 to 1.5	×1 (12A)	–	9 × 15 × 1.82 9 × 15 × 2.42	LGA BGA	LTM4643
1	3.4	40	0.97	18	3.5 (Continuous) 6 (Peak)	0.2 to 3	–	–	6.25 × 9 × 3.32	BGA	LTM8003
1	3.4	40	0.97	15	3.5 (Continuous) 6 (Peak)	0.2 to 3	×2 (7A)	–	6.25 × 9 × 3.32	BGA	LTM8053
1	2.375	5.5	0.8	5	4	–	×2 (8A)	–	9 × 15 × 2.32 9 × 15 × 3.42	LGA BGA	LTM4604A
1	4*	14	0.6	5.5	4	–	–	–	6.25 × 6.25 × 5.01	BGA	LTM4624
1	4.5	60	2.5	24	4	0.1 to 0.5	–	–	15 × 15 × 4.32 15 × 15 × 4.92	LGA BGA	LTM8027
2	2.375	5.5	0.8	5	4	–	×1 (8A)	–	15 × 15 × 2.82	LGA	LTM4614
3	2.375	5.5	0.8	5	4, 4, 1.5	–	×1 (8A)	–	15 × 15 × 2.82	LGA	LTM4615
2	4.5	26.5	0.8	5	4	0.25 to 0.78	×1 (8A)	–	15 × 15 × 2.82	LGA	LTM4619
2	4.5*	20	0.6	5.5	4	0.6 to 1.4	×1 (8A)	–	9 × 11.25 × 4.92	BGA	LTM4642
4	4*	14	0.6	5.5	4	0.7 to 1.3	×1 (16A)	–	9 × 15 × 5.01	BGA	LTM4644
1	6	36	0.8	1.8	5	0.2 to 1.0	×2 (10A)	√	15 × 15 × 4.92	BGA	LTM8028
1	6	36	1.2	24	5	0.1 to 1.0	×2 (10A)	√	11.25 × 15 × 2.82 11.25 × 15 × 3.42	LGA	LTM8026
1	5	36	3.3	15	5	0.2 to 1.3	×2 (10A)	–	15 × 15 × 2.82	LGA	LTM4612
1	4*	20	0.6	5.5	5	0.56 to 4	×2 (10A)	–	6.25 × 6.25 × 5.01	BGA	LTM4625
1	6	36	1.2	24	±5	0.1 to 1.0	–	√	11.25 × 15 × 2.82 11.25 × 15 × 3.42	LGA	LTM8052
1	6	36	1.2	24	±5	0.1 to 1.0	–	√	11.25 × 15 × 2.82 11.25 × 15 × 3.42	LGA	LTM8052A
3	4.75	28	0.8	5.5, 13.5	5, 5, 4	0.25 to 0.75	×1 (10A)	–	15 × 15 × 5.01	BGA	LTM4634
1	4.5	20	0.6	5	6	–	–	–	15 × 15 × 2.82	LGA	LTM4602
1	4.5	20	0.6	5	6	0.7 to 1.3	×4 (24A)	–	15 × 15 × 2.82	LGA	LTM4603
1	4.5	26.5	0.8	5	6	0.25 to 0.78	×2 (12A)	–	9 × 15 × 4.32 9 × 15 × 4.92	LGA BGA	LTM4618
1	4.5	28	0.6	5	6	–	–	–	15 × 15 × 2.82	LGA	LTM4602HV
1	4.5	28	0.6	5	6	0.7 to 1.3	×4 (24A)	–	15 × 15 × 2.82	LGA	LTM4603HV
1	4.5	28	0.6	5	6	0.63 to 1.0	×2 (12A)	–	15 × 15 × 2.82 15 × 15 × 3.42	LGA BGA	LTM4606

*Can be reduced with external bias supply.

**Number of devices in parallel tested and verified by Analog Devices, Inc.



Step-Down (Continued)

Output Channels	Input Voltage (V)		Output Voltage (V)		Output Current (A)	Sync Range (MHz)	Paralleleable** Outputs (Total I _{OUT})	Adjustable Current Limit	Package Dimensions (mm)	Package	Part Number
	Min	Max	Min	Max							
1	6	58	1.2	36	6	0.12 to 1.2	×2 (12A)	√	11.9 × 16 × 4.92	BGA	LTM8064
1	2.7	5.5	0.6	5	8	0.75 to 2.25	×4 (32A)	–	9 × 15 × 2.82	LGA	LTM4608A
2	2.7	5.5	0.6	5	8	0.75 to 2.25	×2 (32A)	–	15 × 15 × 2.82 15 × 15 × 3.42	LGA BGA	LTM4616
2	4.5	26.5	0.6	5.5	8	0.4 to 0.78	×2 (32A)	–	15 × 15 × 4.32 15 × 15 × 4.92	LGA BGA	LTM4628
1	5	36	3.3	15	8	0.2 to 1.3	×2 (16A)	–	15 × 15 × 4.32 15 × 15 × 4.92	LGA BGA	LTM4613
2	4.5	17	0.5	5.5	9	0.25 to 1	×4 (72A)	√	16 × 11.9 × 3.51	BGA	LTM4675
1	2.375	5.5	0.6	5	10	0.35 to 0.65	×3 (30A)	–	9 × 15 × 4.92	BGA	LTM4648
1	4.5	16	0.6	3.3	10	0.4 to 0.75	×3 (30A)	–	9 × 15 × 4.92	BGA	LTM4649
1	4.5	20	0.6	5	10	–	–	–	15 × 15 × 2.82	LGA	LTM4600
1	4.5	28	0.6	5	10	–	–	–	15 × 15 × 2.82	LGA	LTM4600HV
1	4.5	36	0.8	34	10	0.2 to 0.4	×4 (40A)	–	15 × 15 × 2.82 15 × 15 × 3.42	LGA BGA	LTM4609
1	4.5	36	0.8	24	10	0.2 to 0.4	×4 (40A)	–	15 × 15 × 2.82	LGA	LTM4607
1	4.5	38	0.6	6	10	0.175 to 0.66	×4 (40A)	–	15 × 15 × 5.01	BGA	LTM4611
3	4.7*	16	0.8	1.8, 5.5	10	0.6 to 0.75	×1 (20A)	–	15 × 15 × 5.01	BGA	LTM4633
2	4.5	15	0.6	1.8	10	0.5 to 0.78	×2 (40A)	–	16 × 16 × 1.91 16 × 16 × 2.51	LGA BGA	LTM4631
2	4.5	20	0.6	5.5	10	0.25 to 1.3	×2 (40A)	–	9 × 15 × 5.01	BGA	LTM4646
2	4.5	17	0.5	2.75	10	0.25 to 1	×4 (80A)	√	11.9 × 16 × 1.82	LGA	LTM4686
1	4.5	20	0.8	16	12	0.2 to 0.4	×4 (48A)	–	15 × 15 × 2.82	LGA	LTM4605
1	4.5	20	0.6	5	12	0.6 to 1.1	×4 (48A)	–	15 × 15 × 2.82 15 × 15 × 3.42	LGA BGA	LTM4601†
1	4.5	20	0.6	5	12	0.6 to 1.1	×4 (48A)	–	15 × 15 × 2.82 15 × 15 × 3.42	LGA BGA	LTM4601-1†
1	4.5	20	0.6	5	12	0.6 to 1.1	×4 (48A)	–	15 × 15 × 2.82 15 × 15 × 3.42	LGA BGA	LTM4601A†‡
1	4.5	20	0.6	5	12	0.6 to 1.1	×4 (48A)	–	15 × 15 × 2.82 15 × 15 × 3.42	LGA BGA	LTM4601A-1†‡
1	4.5	28	0.6	5	12	0.6 to 1.1	×4 (48A)	–	15 × 15 × 2.82 15 × 15 × 3.42	LGA BGA	LTM4601AHV†‡
1	4.5	28	0.6	5	12	0.6 to 1.1	×4 (48A)	–	15 × 15 × 2.82 15 × 15 × 3.42	LGA BGA	LTM4601HV†
2	4.5	16	0.6	2.5	13	0.4 to 0.78	×4 (100A)	–	15 × 15 × 4.41 15 × 15 × 5.01	LGA BGA	LTM4620
2	4.5	16	0.6	5.3	13	0.4 to 0.78	×4 (100A)	–	15 × 15 × 4.41 15 × 15 × 5.01	LGA BGA	LTM4620A
2	4.5	26.5	0.5	5.5	13	0.25 to 1.0	×4 (100A)	√	16 × 16 × 5.01	BGA	LTM4676A
1	1.5	5.5	0.8	5	15	0.36 to 0.71	×4 (60A)	–	15 × 15 × 4.32	LGA	LTM4611
1	4.5	20	0.6	5	15	0.25 to 0.8	×4 (60A)	–	15 × 15 × 4.32 15 × 15 × 4.92	LGA BGA	LTM4627
2	4.5	15	0.6	1.8	18	0.4 to 0.78	×4 (144A)	–	16 × 16 × 4.41 16 × 16 × 5.01	LGA BGA	LTM4630
2	4.5	15	0.6	1.8	18	0.4 to 0.78	×4 (144A)	–	16 × 16 × 5.01	BGA	LTM4630-1
2	4.5	15	0.6	5.3	18	0.4 to 0.78	×4 (144A)	–	16 × 16 × 4.41 16 × 16 × 5.01	LGA BGA	LTM4630A
2	4.5	16	0.5	1.8	18	0.225 to 1.1	×4 (144A)	√	16 × 16 × 5.01	BGA	LTM4677
1	4.5	20	0.6	5.5	20	0.25 to 0.8	×4 (80A)	–	15 × 15 × 4.32 15 × 15 × 4.92	LGA BGA	LTM4637
1	2.375	7	0.6	5.5	20	0.25 to 0.8	×4 (80A)	–	15 × 15 × 4.92	BGA	LTM4639
1	4.7	15	0.6	1.8	25	0.3 to 1	×4 (100A)	–	9 × 15 × 3.51	BGA	LTM4645
2	4.5	15	0.6	1.8	25	0.4 to 0.78	×6 (300A)	–	16 × 16 × 5.01	BGA	LTM4650
2	4.5	15	0.6	1.8	25	0.4 to 0.78	×6 (300A)	–	16 × 16 × 5.01	BGA	LTM4650-1
2	4.5	16	0.6	5.5	25	0.4 to 0.78	×6 (300A)	–	16 × 16 × 5.01	BGA	LTM4650A
2	4.5	16	0.5	3.3	25	0.2 to 1	×4 (200A)	√	16 × 16 × 5.74	BGA	LTM4678
1	4.6	15	0.6	1.8	30	0.4 to 0.8	×4 (120A)	–	9 × 15 × 5.01	BGA	LTM4647
1	4.7	15	0.6	3.3	40	0.25 to 0.8	×6 (240A)	–	16 × 16 × 7.07	BGA	LTM4636
1	4.7	15	0.6	3.3	40	0.25 to 0.8	×6 (240A)	–	16 × 16 × 7.07	BGA	LTM4636-1

*Can be reduced with external bias supply.

**Number of devices in parallel tested and verified by Analog Devices, Inc.

† LTM4601, LTM4601A, LTM4601HV and LTM4601AHV offer precision remote sense (see page 25). Devices ending with “-1” do not.

‡ LTM4601A, LTM4601A-1 and LTM4601AHV have redundant pads for enhanced solder joint strength to the PCB.



Step-Up

Output Channels	Input Voltage (V)		Output Voltage (V)		Switch Current (A)	Sync Range (MHz)	Paralleleable	Package Dimensions (mm)	Package	Part Number
	Min	Max	Min	Max						
1	1.8*	5.5	2.5	15	4	0.5 to 1.5	Yes	6.25 × 6.25 × 2.42	BGA	LTM4661

*0.7V After start-up



Step-Up & Down

Output Channels	Topology	Input Voltage (V)		Output Voltage (V)		Output Current (A)	Sync Range (MHz)	Paralleleable Outputs (Total I _{OUT})*	Inductor	Package Dimensions (mm)	Package	Part Number
		Min	Max	Min	Max							
1	SEPIC	2.8	18	±2.5	±15	Up to 0.7†	0.2 to 2.0	–	Internal	6.25 × 11.25 × 4.92	BGA	LTM8045
		5	36	1.2	36	5.4†	0.2 to 0.7	×2 (10.8A)	Internal	11.25 × 15 × 3.42	BGA	LTM8054
	4-Switch Buck-Boost	5	58	1.2	48	5.4†	0.2 to 0.7	×2 (10.8A)	Internal	15 × 15 × 4.92	BGA	LTM8056
		5	36	1.2	36	8.5†	0.2 to 0.7	×2 (17A)	Internal	15 × 15 × 4.92	BGA	LTM8055
		4.5	36	0.8	24	10†	0.2 to 0.4	×4 (20A)††	External	15 × 15 × 2.82	LGA	LTM4607
		4.5	36	0.8	34	10†	0.2 to 0.4	×4 (16A)††	External	15 × 15 × 2.82 15 × 15 × 3.42	LGA BGA	LTM4609
2	SEPIC	2.6	20	±2.4	±24	Up to 1†	0.2 to 2.5	×2 (2A)	Internal	9 × 15 × 2.42	BGA	LTM8049

†Step-down mode. Output current varies depending on operating mode.

††Step-up mode

*Number of devices in parallel tested and verified by Analog Devices, Inc.



Digital Power System Management

Function	# of Output	Input Voltage (V)		Output Voltage (V)		Output Current (A)	Read Back Accuracy		Turn-On Time (ms)	BGA Package Dimensions (mm)	Part Number
		Min	Max	Min	Max		Voltage	Current			
Step-Down	2	4.5	17	0.5	5.5	Dual: 9	0.5%	2.5%	35	11.9 × 16 × 3.51	LTM4675
	2	4.5	17	0.5	2.75	Dual: 10	0.5%	25%	35	11.9 × 16 × 1.82	LTM4686
	2	4.5	26.5	0.5	5.5	Dual: 13	0.5%	2.5%	35	16 × 16 × 5.01	LTM4676A
	2	4.4	16	0.5	1.8	Dual: 18	0.5%	2.5%	35	16 × 16 × 5.01	LTM4677
	2	4.5	16	0.5	3.3	Dual: 25	0.5%	25%	30	16 × 16 × 5.74	LTM4678



Isolated

Isolation	# of Output	Input Voltage (V)		Output Voltage (V)		Output Ripple	Output Power	UL Recognized	BGA Package Dimensions (mm)	Part Number
		Min	Max	Min	Max					
725VDC	1	3.1	32	2.5	12	20mVRMS	1.5W	–	9 × 11.25 × 4.92	LTM8047
	2	3.1	32	1.2	12	20µVRMS (V _{OUT2})	1.5W Combined	–	9 × 11.25 × 4.92	LTM8048
2kVAC (3kVDC)	1	3.1	31	2.5	12	20mVRMS	1.5W	UL60950	9 × 11.25 × 4.92	LTM8057
	2	3.1	31	1.2	12	20µVRMS (V _{OUT2})	1.5W Combined	UL60950	9 × 11.25 × 4.92	LTM8058
	1	2.8	40	2.5	24	30mVRMS	2.25W	UL60950	9 × 11.25 × 4.92	LTM8067
	2	2.8	40	1.2	18	20µVRMS (V _{OUT2})	2.25W Combined	UL60950	9 × 11.25 × 4.92	LTM8068
	1	3.1	31	1.8	12	20mVRMS	2.5W	UL60950	9 × 15 × 4.92	LTM8046



Inverting

Inverting Isolated and SEPIC										
Topology	Input Voltage (V)		Output Voltage (V)		Total Output Capability	Clock Sync Range (MHz)	UL60950 Recognized	BGA Package Dimensions (mm)	Package Type	Part Number
	Min	Max	Min	Max						
SEPIC	2.8	18	-2.5	-15	Up to 0.7A	0.2 to 2.0	–	6.25 × 11.25 × 4.92	BGA	LTM8045
	2.6	20	-2.4	-24	Up to 1A	0.2 to 2.5	–	9 × 15 × 2.42	BGA	LTM8049
725VDC Isolated Flyback	3.1	32	-2.5	-12	1.5W	–	–	9 × 11.25 × 4.92	BGA	LTM8047
2kV Isolated Flyback	3.1	31	-2.5	-12	1.5W	–	√	9 × 11.25 × 4.92	BGA	LTM8057
	2.8	40	-2.5	-24	2.25W	–	√	9 × 11.25 × 4.92	BGA	LTM8067
	3.1	31	-1.8	-12	2.5W	–	√	9 × 15 × 4.92	BGA	LTM8046
Inverting Switching Regulator										
Topology	Input Voltage (V)		Output Voltage (V)		Total Output Capability	Clock Sync Range (MHz)	EMI Compliant	Package Dimensions (mm)	Package Type	Part Number
	Min	Max	Min	Max						
Switching Regulator	3.6	58	-0.6	-5.5	4A	0.25 to 3	EN55022 Class B	9 × 15 × 5.01	BGA	LTM4651
Buck Converter Configured as Inverting										
Buck Converter	4	36	-1.25	-5	0.2	–	–	6.25 × 6.25 × 2.32	LGA	LTM8020
	3	36	-0.8	-5	0.5	–	–	11.25 × 6.25 × 2.82	LGA	LTM8021
	4.5	36	-1.2	-18	0.6	–	–	11.25 × 6.25 × 3.42	BGA	LTM8029
	3.6	36	-0.8	-10	1	0.25 to 2	–	11.25 × 9 × 2.82	LGA	LTM8022
	3.6	36	-0.8	-10	2	0.25 to 2	–	11.25 × 9 × 2.82 11.25 × 9 × 3.42	LGA BGA	LTM8023
	3.6	58	-0.8	-24	2	0.25 to 2.0	–	9 × 15 × 4.92	BGA	LTM8050
	3.2	40	0.8	-15	2 (Continuous) 2.5 (Peak)	0.2 to 2.2	CISPR 22 Class B	4 × 6.25 × 2.22	BGA	LTM8063
	3.4	40	0.97	-18	2 (Continuous) 3.5 (Peak)	0.2 to 3	CISPR 22 Class B	6.25 × 6.25 × 2.32	BGA	LTM8065
	3.6	36	-0.8	-24	3	0.25 to 2	–	9 × 15 × 4.32 9 × 11.25 × 4.92	LGA BGA	LTM8025
	3.4	60	-0.8	-15	3 (Continuous) 5 (Peak)	0.2 to 3	–	6.25 × 9 × 3.32	BGA	LTM8073
	3.4	40	-0.97	-18	3.5 (Continuous) 6 (Peak)	0.2 to 3	–	6.25 × 9 × 3.32	BGA	LTM8003
	3.4	40	-0.97	-15	3.5 (Continuous) 6 (Peak)	0.2 to 3	–	6.25 × 9 × 3.32	BGA	LTM8053
	4.5	60	-2.5	-24	4	0.1 to 0.5	–	15 × 15 × 4.32 15 × 15 × 4.92	LGA BGA	LTM8027
	6	36	-1.2	-24	5	0.1 to 1	–	11.25 × 15 × 2.82 11.25 × 15 × 3.42	LGA BGA	LTM8026
	6	36	-1.2	-24	5	0.1 to 1	–	11.25 × 15 × 2.82 11.25 × 15 × 3.42	LGA BGA	LTM8052
	6	58	-1.2	-36	6	0.12 to 1.2	–	11.9 × 16 × 4.92	BGA	LTM8064

Note: The parts above represent the simplest μ Module power product solution for inverting regulators. While all μ Module step-down regulators can be reconfigured as an inverter on the PCB, they are subject to three extra design steps as described in Design Note DN1021 at cds.linear.com/docs/en/design-note/dn1021fa.pdf



Battery Chargers

Input Voltage (V)		Output Voltage (V)		Maximum Charge Current (A)	Supported Battery Chemistries	Adjustable Current Limit	MPPT	Auto Recharge	Paralleable Outputs (Total I _{OUT})	LGA Package Dimensions (mm)	Part Number
Min	Max	Min	Max								
4.95	32	4.1	8.4	2	Li-Ion, Li-Polymer	√	–	√	–	9 × 15 × 4.32	LTM8061
4.95	32	3.3	14.4	2	Li-Ion, Li-Polymer, SLA, LiFePO4	–	√	√	×3 (6A)	9 × 15 × 4.32	LTM8062
4.95	32	3.3	18.8	2	Li-Ion, Li-Polymer, SLA, LiFePO4	–	√	√	×3 (6A)	9 × 15 × 4.32	LTM8062A



LED Drivers

Input Voltage (V)		Output Voltage (V)		LED Drive Current (A)	Dimming	Clock Sync Range (MHz)	Open LED Protection	LGA Package Dimensions (mm)	Part Number
Min	Max	Min	Max						
3	30	2	32	1	Analog and PWM	0.3 to 2.5	√	9 × 15 × 2.82	LTM8042
3	30	2	32	0.35	Analog and PWM	0.3 to 2.5	√	9 × 15 × 2.82	LTM8042-1
4	36	2.5	13	1	Analog and PWM	–	√	9 × 15 × 4.32	LTM8040
5	38	1.25	38	1.6	Analog and PWM	–	√	9 × 11.25 × 2.22	LTM8005



Multiple Output

Function	# of Outputs	Input Voltage (V)		Output Voltage (V)		Output Current (A)	Clock Sync Range (MHz)	Parallelable Outputs (Total I _{OUT})**	Package Dimensions (mm)	Package	Part Number	
		Min	Max	Min	Max							
Step-Down	2	3.6	20	1.5	12	Dual: 2A	0.56 to 4	×2 (8A)	6.25 × 6.25 × 1.82 6.25 × 6.25 × 2.42	LGA BGA	LTM4622A	
		3.6*	20	0.5	5.5	Dual: 2.5A	0.56 to 4	×2 (10A)	6.25 × 6.25 × 1.82 6.25 × 6.25 × 2.42	LGA BGA	LTM4622	
		2.375	5.5	0.8	5	Dual: 4A	–	×1 (8A)	15 × 15 × 2.82	LGA	LTM4614	
		4.5	26.5	0.8	5	Dual: 4A	0.25 to 0.78	×1 (8A)	15 × 15 × 2.82	LGA	LTM4619	
		4.5*	20	0.6	5.5	Dual: 4A	0.6 to 1.6	×1 (8A)	9 × 11.25 × 4.92	BGA	LTM4642	
		2.7	5.5	0.6	5	Dual: 8A	0.75 to 2.25	×2 (32A)	15 × 15 × 2.82 15 × 15 × 3.42	LGA BGA	LTM4616	
		4.5	26.5	0.6	5.5	Dual: 8A	0.4 to 0.78	×2 (32A)	15 × 15 × 4.32 15 × 15 × 4.92	LGA BGA	LTM4628	
		4.5	17	0.5	5	Dual: 9A	0.25 to 1.0	×4 (72A)	16 × 11.9 × 3.51	BGA	LTM4675	
		4.5	15	0.6	1.8	Dual: 10A	0.55 to 0.75	×2 (40A)	16 × 16 × 1.91 16 × 16 × 2.51	LGA BGA	LTM4631	
		4.5	17	0.5	2.75	Dual: 10A	0.25 to 1	×4 (80A)	16 × 16 × 1.82	LGA	LTM4686	
		4.5	20	0.6	5.5	Dual: 4A	0.2 to 1.3	×2 (40A)	11.25 × 15 × 5.01	BGA	LTM4646	
		4.5	16	0.6	2.5	Dual: 13A	0.4 to 0.78	×4 (100A)	15 × 15 × 4.41 15 × 15 × 5.01	LGA BGA	LTM4620	
		4.5	16	0.6	5.3	Dual: 13A	0.4 to 0.78	×4 (100A)	15 × 15 × 4.41 15 × 15 × 5.01	LGA BGA	LTM4620A	
		4.5	26.5	0.5	5.5	Dual: 13A	0.25 to 1.0	×4 (100A)	16 × 16 × 5.01	BGA	LTM4676A	
		4.5	20	0.6	5.5	Dual: 15A	0.25 to 1.0	×2 (6A)	11.25 × 15 × 5.74	BGA	LTM4662	
		4.5	15	0.6	1.8	Dual: 18A	0.4 to 0.78	×4 (144A)	16 × 16 × 4.41 16 × 16 × 5.01	LGA BGA	LTM4630	
		4.5	15	0.6	1.8	Dual: 18A	0.4 to 0.78	×4 (144A)	16 × 16 × 5.01	BGA	LTM4630-1	
		4.5	15	0.6	5.3	Dual: 18A	0.4 to 0.78	×4 (144A)	16 × 16 × 4.41	LGA	LTM4630A	
		4.5	16	0.5	1.8	Dual: 18A	0.25 to 1.1	×4 (200A)	16 × 16 × 5.01	BGA	LTM4677	
		4.5	15	0.6	1.8	Dual: 25A	0.4 to 0.78	×6 (300A)	16 × 16 × 5.01	BGA	LTM4650	
		4.5	15	0.6	1.8	Dual: 25A	0.4 to 0.78	×6 (300A)	16 × 16 × 5.01	BGA	LTM4650-1	
		4.5	16	0.6	5.5	Dual: 25A	0.4 to 0.78	×6 (300A)	16 × 16 × 5.01	BGA	LTM4650A	
		4.5	17	0.5	3.3	Dual: 25A	0.2 to 1.3	×4 (200A)	16 × 16 × 5.74	BGA	LTM4678	
			3	3.6*	15	0.6	2.5	Triple: 3A, 3A, 10mA	0.56 to 4	×2 (12A)	6.25 × 6.25 × 1.82 6.25 × 6.25 × 2.42	LGA BGA
2.375	5.5			0.8	5	Triple: 4A, 4A, 1.5A	–	×1 (8A)	15 × 15 × 2.82	LGA	LTM4615	
4.75	28			0.8	5.5, 13.5	Triple: 5A, 5A, 4A	0.25 to 0.75	×1 (10A)	15 × 15 × 5.01	BGA	LTM4634	
4.7*	16			0.8	1.8, 5.5	Triple: 10A	0.6 to 0.75	×1 (20A)	15 × 15 × 5.01	BGA	LTM4633	
4	4*		20	0.6	3.3	Quad: 3A	0.85 to 1.5	×1 (16A)	9 × 15 × 1.82 9 × 15 × 2.42	LGA BGA	LTM4643	
	4*		14	0.6	5.5	Quad: 4A	0.7 to 1.3	×1 (16A)	9 × 15 × 5.01	BGA	LTM4644	
5	6		36	0	24	Five: 1A	0.2 to 1.0	×2 (10A)	15 × 15 × 3.42	BGA	LTM8001	
	Isolated Flyback		2	3.1	32	1.2	12	1.5W Combined	–	–	9 × 11.25 × 4.92	BGA
3.1	21			1.2	12	1.5W Combined	–	–	9 × 11.25 × 4.92	BGA	LTM8058	
2.8	40			1.2	18	2.25W Combined	–	–	9 × 11.25 × 4.92	BGA	LTM8068	

*Can be reduced with external bias supply.

**Number of devices in parallel tested and verified by Analog Devices, Inc.



Low V_{IN} ($\leq 3V$)

Function	# of Output	Input Voltage (V)		Output Voltage (V)		Output Current (A)	Clock Sync Range (MHz)	Package Dimensions (mm)	Package	Part Number
		Min	Max	Min	Max					
Step-Down	1	1.5	5.5	0.8	5	15	0.36 to 0.71	15 × 15 × 4.32	LGA	LTM4611
		2.375*	20	0.5	5.5	3	0.56 to 4	6.25 × 6.25 × 1.82 6.25 × 6.25 × 2.42	LGA BGA	LTM4623
		2.375	5.5	0.8	5	4	–	9 × 15 × 2.32 9 × 15 × 3.42	LGA BGA	LTM4604A
		2.375*	14	0.6	5.5	4	–	6.25 × 6.25 × 5.01	BGA	LTM4624
		2.375*	20	0.6	5.5	5	0.56 to 4	6.25 × 6.25 × 5.01	BGA	LTM4625
		2.375*	7	0.6	5.5	20	0.25 to 0.8	15 × 15 × 4.92	BGA	LTM4639
		2.375	5	0.6	5	10	0.35 to 0.65	9 × 15 × 4.92	BGA	LTM4648
		2.7	5	0.6	5	8	0.75 to 2.25	9 × 15 × 2.82	LGA	LTM4608A
	2	3	36	0.8	5	0.5	–	6.25 × 11.25 × 2.82	LGA	LTM8021
		2.375	5.5	0.8	5	Dual: 4, 4	–	15 × 15 × 2.82	LGA	LTM4614
		2.375*	20	0.6	5.5	Dual: 4, 4	0.6 to 1.4	8 × 11.25 × 4.92	BGA	LTM4642
		2.7	5.5	0.6	5	Dual: 8, 8	0.75 to 2.25	15 × 15 × 2.82 15 × 15 × 3.42	LGA BGA	LTM4616
		3*	20	0.6	5.5	Dual: 2.5, 2.5	0.56 to 4	6.25 × 6.25 × 1.82 6.25 × 6.25 × 2.42	LGA BGA	LTM4622
		2.375*	20	0.6	5.5	Dual: 10, 10	0.25 to 1.3	9 × 15 × 5.01	BGA	LTM4646
		2.375	5.5	0.8	5	Triple: 4, 4, 1.5	–	15 × 15 × 2.82	LGA	LTM4615
		3	3	15	0.6	2.5	Triple: 3, 3, 10mA	0.56 to 4	6.25 × 6.25 × 1.82 6.25 × 6.25 × 2.42	LGA BGA
	4	2.375*	20	0.6	3.3	Quad: 4	0.85 to 1.5	9 × 15 × 1.82 9 × 15 × 2.42	LGA BGA	LTM4643
		2.375*	14	0.6	5.5	Quad: 4	0.7 to 1.3	9 × 15 × 5.01	BGA	LTM4644
Isolated	1	2.8	40	2.5	24	0.45	–	9 × 11.25 × 4.92	BGA	LTM8067
	2	2.8	40	2.5	18	0.45	–	9 × 11.25 × 4.92	BGA	LTM8068
Step-Up & Down	1	2.8	18	±2.5	±15	Up to 0.7	0.2 to 2	6.25 × 11.25 × 4.92	BGA	LTM8045
	2	2.6	20	±2.5	±24	Dual: up to 1A	0.2 to 2.5	9 × 15 × 2.42	BGA	LTM8049
LED Driver	1	3	30	2	32	1	0.3 to 2.5	9 × 15 × 2.82	LGA	LTM8042
		3	30	2	32	0.35	0.3 to 2.5	9 × 15 × 2.82	LGA	LTM8042-1

* Requires external bias

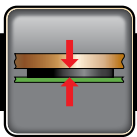

Ultrathin

Function	# of Outputs	Input Voltage (V)		Output Voltage (V)		Output Current (A)	Clock Sync Range (MHz)	Parallelable Outputs (Total I_{OUT})**	Package Dimensions (mm)	Package	Part Number
		Min	Max	Min	Max						
Step-Down	1	4*	20	0.6	5.5	3	0.56 to 4	×2 (6A)	6.25 × 6.25 × 1.82 6.25 × 6.25 × 2.42	LGA BGA	LTM4623
	2	3.6*	20	1.5	12	Dual: 2	0.56 to 4	×2 (8A)	6.25 × 6.25 × 1.82 6.25 × 6.25 × 2.42	LGA BGA	LTM4622A
		3.6*	20	0.6	5.5	Dual: 2.5	0.56 to 4	×2 (10A)	6.25 × 6.25 × 1.82 6.25 × 6.25 × 2.42	LGA BGA	LTM4622
		4.5	15	0.6	1.8	Dual: 10	0.4 to 0.78	×2 (40A)	16 × 16 × 1.91	LGA	LTM4631
	4.5	17	0.5	2.75	Dual: 10	0.25 to 1	×4 (80A)	16 × 16 × 1.82	LGA	LTM4686	
4	4*	20	0.6	3.3	Quad: 3	0.8 to 1.5	×1 (12A)	9 × 15 × 1.82 9 × 15 × 2.42	LGA BGA	LTM4643	
Power for DDR & QDR Memory	3	3.6*	15	0.6	1.8	Dual: 3 (VDDQ, VTT) 10mA (VTTR)	0.7 to 1.3	×2 (12A)	6.25 × 6.25 × 1.82 6.25 × 6.25 × 2.42	LGA BGA	LTM4632

*See data sheet for lower voltage operation

** Number of devices in parallel tested and verified by Analog Devices, Inc.



Function	Input Voltage (V)		Output Voltage (V)		Output Current (A)	EMI Standard	Clock Sync Range (MHz)	Package Dimensions (mm)	Package	Part Number
	Min	Max	Min	Max						
Step-Down	4	36	1.2	5	0.2	EN55022 Class B	–	6.25 × 6.25 × 2.32	LGA	LTM8020
	3	36	0.8	5	0.5	EN55022 Class B	–	6.25 × 11.25 × 2.82	LGA	LTM8021
	3.6	36	0.8	10	1	EN55022 Class B	0.25 to 2.0	9 × 15 × 2.82	LGA	LTM8031
	3.6	36	0.8	10	2	EN55022 Class B	0.25 to 2.0	9 × 15 × 2.82 9 × 15 × 3.42	LGA BGA	LTM8032
	3.2	40	0.8	15	2 (Continuous) 2.5 (Peak)	CISPR 22 Class B	0.2 to 2.2	4 × 6.25 × 2.22	BGA	LTM8063
	3.4	40	0.97	18	2 (Continuous) 3.5 (Peak)	CISPR 22 Class B	0.2 to 3	6.25 × 6.25 × 2.32	BGA	LTM8065
	3.6	36	0.8	24	3	EN55022 Class B	0.25 to 2.0	11.25 × 15 × 4.32 11.25 × 15 × 4.92	LGA BGA	LTM8033
	4*	20	0.6	5.5	3	EN55022 Class B	0.56 to 4	6.25 × 6.25 × 1.82 6.25 × 6.25 × 2.42	LGA BGA	LTM4623
	3.4	60	0.8	15	3 (Continuous) 5 (peak)	CISPR 22 Class B	0.2 to 3	6.25 × 9 × 3.32	BGA	LTM8073
	3.4	40	0.97	18	3.5 (Continuous) 6 (peak)	CISPR 25 Class 5	–	6.25 × 9 × 3.32	BGA	LTM8003
	3.4	40	0.97	15	3.5 (Continuous) 6 (peak)	CISPR 22 Class B	0.2 to 3	6.25 × 9 × 3.32	BGA	LTM8053
	4*	14	0.6	5.5	4	EN55022 Class B	–	6.25 × 6.25 × 5.01	BGA	LTM4624
	3.6	58	–0.5	–26.5	4	EN55022 Class B	0.25 to 3	9 × 15 × 5.01	BGA	LTM4651
	5	36	3.3	15	5	EN55022 Class B	0.18 to 1.3	15 × 15 × 2.82	LGA	LTM4612
	4.5	28	0.6	5	6	EN55022 Class B	0.7 to 1.1	15 × 15 × 2.82 15 × 15 × 3.42	LGA BGA	LTM4606
5	36	3.3	15	8	EN55022 Class B	0.18 to 1.3	15 × 15 × 4.32 15 × 15 × 4.92	LGA BGA	LTM4613	

*Can be reduced with external bias supply

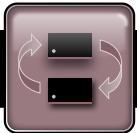

Pin Compatible

Function	Device 1	Device2	Device 3	Device 4
Step-Down	LTM8022 (36V _{IN} , 1A)	LTM8023 (36V _{IN} , 2A)		
	LTM4602 (20V _{IN} , 6A)	LTM4600 (20V _{IN} , 10A)		
	LTM4603 (20V _{IN} , 6A)	LTM4601 (20V _{IN} , 12A)		
	LTM4627 (20V _{IN} , 15A)	LTM4637 (20V _{IN} , 20A)		
	LTM4623 (20V _{IN} , 3A)	LTM4625 (20V _{IN} , 5A)		
	LTM4648 (5.5V _{IN} , 10A)	LTM4649 (16V _{IN} , 10A)		
	LTM4647 (15V _{IN} , 30A)	LTM4645 (15V, 25A)		
Dual Step-Down	LTM4628 (5.5V _{OUT} , 2 × 8A)	LTM4620/LTM4620A (2 × 13A)	LTM4630/LTM4630-1/LTM4630A (2 × 18A)	LTM4650/LTM4650-1 (2 × 25A)
	LTM4643 (4 × 3A)	LTM4644 (4 × 4A)		
Dual Step-Down with PSM	LTM4675 (2 × 9A)	LTM4686 (2 × 10A Ultrathin)		
	LTM4676A (2 × 13A)	LTM4677 (2 × 18A)		
Low EMI Step-Down	LTM8031 (36V _{IN} , 1A)	LTM8032 (36V _{IN} , 2A)		
	LTM4606 (28V _{IN} , 6A)	LTM4612 (36V _{IN} , 5A)		
	LTM8053 (40V _{IN} , 3.5A)	LTM8073 (60V _{IN} , 3A)		
Step-Up and Down	LTM4605 (16V _{OUT} , 5A)	LTM4607 (24V _{OUT} , 5A)	LTM4609 (34V _{OUT} , 4A)	
	LTM8055 (36V _{IN} , 36V _{OUT} , 8.5A)	LTM8056 (58V _{IN} , 48V _{OUT} , 5.4A)		



Wide Temperature Range

Function	# of Outputs	Input Voltage (V)		Output Voltage (V)		Output Capability per Channel	Clock Sync Range (MHz)	EN55022B Certified	Package Dimensions (mm)	Package	Part Number	
		Min	Max	Min	Max							
725V Isolated Flyback	1	3.1	32	2.5	12	1.5W	–	–	9 × 11.25 × 4.92	BGA	LTM8047MP	
	2	3.1	32	1.2	12	1.5W Combined	–	–	9 × 11.25 × 4.92	BGA	LTM8048MP	
2kVAC (3kVDC) Isolated Flyback	1	3.1	31	2.5	12	1.5W	–	–	9 × 11.25 × 4.92	BGA	LTM8057MP	
	2	3.1	31	1.2	12	1.5W Combined	–	–	9 × 11.25 × 4.92	BGA	LTM8058MP	
	1	3.1	31	1.8	12	2.5W	–	–	9 × 15 × 4.92	BGA	LTM8046MP	
Step-Up & Down	1	2.8	18	±2.5	±15	Up to 0.7A	0.2 to 2.0	–	6.25 × 11.25 × 4.92	BGA	LTM8045MP	
		5	36	1.2	36	5.4A†	0.2 to 0.7	–	11.25 × 15 × 3.42	BGA	LTM8054MP	
		5	58	1.2	48	5.4A†	0.2 to 0.7	–	15 × 15 × 4.92	BGA	LTM8056MP	
		5	36	1.2	36	8.5A†	0.2 to 0.7	–	15 × 15 × 4.92	BGA	LTM8055MP	
		4.5	36	0.8	34	4A†	0.2 to 0.4	–	15 × 15 × 2.82 15 × 15 × 3.42	LGA BGA	LTM4609MP	
Step-Down	1	4	36	1.2	5	0.2A	–	√	6.25 × 6.25 × 2.32	LGA	LTM8020MP	
		4.5	36	1.2	18	0.6A	–	–	6.25 × 11.25 × 3.42	BGA	LTM8029MP	
		3.6	36	0.8	10	1A	0.25 to 2.0	–	9 × 11.25 × 2.82	LGA	LTM8022MP	
		3.6	36	0.8	10	1A	0.25 to 2.0	√	9 × 15 × 2.82	LGA	LTM8031MP	
		3.6	36	0.8	10	2A	0.25 to 2.0	–	9 × 11.25 × 2.82 9 × 11.25 × 3.42	LGA BGA	LTM8023MP	
		3.6	36	0.8	10	2A	0.25 to 2.0	√	9 × 15 × 2.82 9 × 15 × 3.4	LGA BGA	LTM8032MP	
		3.6	58	0.8	24	2A	0.25 to 2.0	–	9 × 15 × 4.92	BGA	LTM8050MP	
		3.6	36	0.8	24	3A	0.25 to 2.0	–	9 × 15 × 4.32 9 × 15 × 4.92	LGA BGA	LTM8025MP	
		3.6	36	0.8	24	3A	0.25 to 2.0	√	11.25 × 15 × 4.32 11.25 × 15 × 4.92	LGA BGA	LTM8033MP	
		4.5	60	2.5	24	4A	0.12 to 0.5	–	15 × 15 × 4.32 11.25 × 15 × 4.92	LGA BGA	LTM8027MP	
		6	36	1.2	24	5A	0.1 to 1.0	–	11.25 × 15 × 2.82	LGA	LTM8026MP	
		6	36	0.8	1.8	5A	0.2 to 1.0	–	15 × 15 × 4.92	BGA	LTM8028MP	
		5	36	3.3	15	5A	0.2 to 1.3	√	15 × 15 × 2.82	LGA	LTM4612MP	
		6	36	1.2	24	±5A	0.1 to 1	–	11.25 × 15 × 2.82	LGA	LTM8052MP	
		6	36	1.2	24	±5A	0.1 to 1	–	11.25 × 15 × 2.82	LGA	LTM8052AMP	
		4.5	28	0.6	5	6A	0.63 to 1.0	√	15 × 15 × 2.82 15 × 15 × 3.42	LGA BGA	LTM4606MP	
		2.7	5.5	0.6	5	8A	0.75 to 2.25	–	9 × 15 × 2.82	LGA	LTM4608AMP	
		5	36	3.3	15	8A	0.2 to 1.3	√	15 × 15 × 4.32	LGA	LTM4613MP	
		4.5	28	0.6	5	10A	–	–	15 × 15 × 2.82	LGA	LTM4600HVMP	
		4.5	38	0.6	6	10A	0.175 to 0.66	–	15 × 15 × 5.01	BGA	LTM4641MP	
		4.5	28	0.6	5	12A	0.6 to 1.1	–	15 × 15 × 2.82 15 × 15 × 3.42	LGA BGA	LTM4601AHVMP	
		4.5	20	0.6	5	15A	0.25 to 0.8	–	15 × 15 × 4.32 15 × 15 × 4.92	LGA BGA	LTM4627MP	
		2	2.7	5.5	0.6	5	8A	0.75 to 2.25	–	15 × 15 × 2.82 15 × 15 × 3.42	LGA BGA	LTM4616MP
			4.5	16	0.6	2.5	13A	0.4 to 0.78	–	15 × 15 × 5.01	BGA	LTM4620MP
		3	4.7*	16	0.8	1.8, 5.5	10A	0.6 to 0.75	–	15 × 15 × 5.01	BGA	LTM4633MP
		4	4*	20	0.6	3.3	3A	0.85 to 1.5	–	9 × 15 × 1.82 9 × 15 × 2.42	LGA BGA	LTM4643MP
			4*	14	0.6	5.5	4A	0.7 to 1.3	–	9 × 15 × 5.01	BGA	LTM4644MP
6	6	36	0	24	1A	0.2 to 1.0	–	15 × 15 × 3.42	BGA	LTM8001MP		

*Can be reduced with external bias supply.

†Output current vary depending on operation mode.



SnPb BGA

Function	Input Voltage (V)		Output Voltage (V)		Output Capability per Channel	Isolation Rating	Extended Temp Range	Paralleleable Outputs (Total I _{OUT})**	BGA Package Dimensions (mm)	Part Number
	Min	Max	Min	Max						
Step-Up & Down	2.8	18	±2.5	±15	Up to 0.7A	Non-Isolated	-55°C to 125°C	-	6.25 × 11.25 × 4.92	LTM8045
	4.5	36	0.8	34	4A†	Non-Isolated	-55°C to 125°C	×4 (16A)	15 × 15 × 3.42	LTM4609
	5	36	1.2	36	5.5A	Non-Isolated	-55°C to 125°C	×2 (11A)	11.25 × 15 × 3.42	LTM8054
	5	58	1.2	48	5.4A	Non-Isolated	-55°C to 125°C	×2 (10.8A)	15 × 15 × 4.92	LTM8056
	5	36	1.2	36	8.5A	Non-Isolated	-55°C to 125°C	×2 (17A)	15 × 15 × 4.92	LTM8055
Isolated	3.1	32	2.5	12	1.5W	725VDC	-55°C to 125°C	-	9 × 11.25 × 4.92	LTM8047
	3.1	32	1.2	12	1.5W Combined	725VDC	-55°C to 125°C	-	9 × 11.25 × 4.92	LTM8048
	3.1	31	2.5	12	1.5W	2kVAC (3kVDC)	-55°C to 125°C	-	9 × 11.25 × 4.92	LTM8057
	3.1	31	1.2	12	1.5W Combined	2kVAC (3kVDC)	-55°C to 125°C	-	9 × 11.25 × 4.92	LTM8058
	2.8	40	2.5	24	2.25W	2kVAC (3kVDC)	-	-	9 × 11.25 × 4.92	LTM8067
	2.8	40	2.5	18	2.25W	2kVAC (3kVDC)	-	-	9 × 11.25 × 4.92	LTM8068
	3.1	31	1.8	12	2.5W	2kVAC (3kVDC)	-55°C to 125°C	-	9 × 15 × 4.92	LTM8046
Single Output Step-Down	3.6	36	0.8	10	2A	Non-Isolated	-55°C to 125°C	×2 (4A)	9 × 11.25 × 3.42	LTM8023
	3.6	36	0.8	10	2A	Non-Isolated	-55°C to 125°C	×2 (4A)	9 × 15 × 3.42	LTM8032
	3.6	58	0.8	24	2A	Non-Isolated	-55°C to 125°C	×2 (4A)	9 × 15 × 4.92	LTM8050
	4*	20	0.6	5.5	3A	Non-Isolated	-	×2 (6A)	6.25 × 6.25 × 2.42	LTM4623
	3.6	36	0.8	24	3A	Non-Isolated	-55°C to 125°C	×2 (6A)	9 × 15 × 4.92	LTM8025
	3.6	36	0.8	24	3A	Non-Isolated	-55°C to 125°C	×2 (6A)	11.25 × 15 × 4.92	LTM8033
	3.4	40	0.97	18	3.5A (Continuous) 6A (Peak)	Non-Isolated	-40°C to 150°C	×2 (7A)	6.25 × 9 × 3.32	LTM8003
	2.375	5.5	0.8	5	4A	Non-Isolated	-	×2 (8A)	9 × 15 × 3.42	LTM4604A
	4*	14	0.6	5.5	4A	Non-Isolated	-	-	6.25 × 6.25 × 5.01	LTM4624
	4.5	60	2.5	24	4A	Non-Isolated	-55°C to 125°C	×2 (8A)	15 × 15 × 4.92	LTM8027
	4*	20	0.6	5.5	5A	Non-Isolated	-	×2 (10A)	6.25 × 6.25 × 5.01	LTM4625
	6	36	1.2	24	5A	Non-Isolated	-55°C to 125°C	×2 (10A)	11.25 × 15 × 3.42	LTM8026
	6	36	0.8	1.8	5A	Non-Isolated	-55°C to 125°C	×2 (10A)	15 × 15 × 4.92	LTM8028
	6	36	1.2	24	±5A	Non-Isolated	-55°C to 125°C	×2 (10A)	11.25 × 15 × 3.42	LTM8052
	4.5	28	0.6	5	6A	Non-Isolated	-55°C to 125°C	×2 (12A)	15 × 15 × 3.42	LTM4606
	6	58	1.2	36	6A	Non-Isolated	-	×2 (12A)	11.9 × 16 × 4.92	LTM8064
	2.7	5.5	0.6	5	8A	Non-Isolated	-55°C to 125°C	×2 (16A)	9 × 15 × 3.42	LTM4608A
	5	36	3.3	15	8A	Non-Isolated	-55°C to 125°C	×2 (16A)	15 × 15 × 4.92	LTM4613
	2.375	5.5	0.6	5	10A	Non-Isolated	-	×3 (30A)	9 × 15 × 4.92	LTM4648
	4.5	16	0.6	3.3	10A	Non-Isolated	-	×3 (30A)	9 × 15 × 4.92	LTM4649
	4.5	38	0.6	6	10A	Non-Isolated	-55°C to 125°C	×4 (40A)	15 × 15 × 5.02	LTM4641
	4.5	20	0.6	5	12A	Non-Isolated	-	×4 (48A)	15 × 15 × 3.42	LTM4601†
	4.5	20	0.6	5	12A	Non-Isolated	-	×4 (48A)	15 × 15 × 3.42	LTM4601-1†
	4.5	20	0.6	5	12A	Non-Isolated	-	×4 (48A)	15 × 15 × 3.42	LTM4601A†‡
	4.5	20	0.6	5	12A	Non-Isolated	-	×4 (48A)	15 × 15 × 3.42	LTM4601A-1†‡
	4.5	28	0.6	5	12A	Non-Isolated	-55°C to 125°C	×4 (48A)	15 × 15 × 3.42	LTM4601AHV†‡
	4.5	20	0.6	5	15A	Non-Isolated	-55°C to 125°C	×4 (60A)	15 × 15 × 4.92	LTM4627
	4.5	20	0.6	5.5	20A	Non-Isolated	-	×4 (80A)	15 × 15 × 4.92	LTM4637
	2.375	7	0.6	5.5	20A	Non-Isolated	-	×4 (80A)	15 × 15 × 4.92	LTM4639
	4.7	15	0.6	1.8	25A	Non-Isolated	-	×4 (100A)	9 × 15 × 3.51	LTM4645
4.7	15	0.6	1.8	30A	Non-Isolated	-	×6 (180A)	9 × 15 × 5.01	LTM4647	

*Can be reduced with external bias supply.

** Number of devices in parallel tested and verified by Analog Devices, Inc..

†In Step-up mode. Output current in step-down mode is approximately 2x greater.

‡LTM4601, LTM4601A, LTM4601HV and LTM4601AHV offer precision remote sense (see page 25). Devices ending with “-1” do not.

‡LTM4601A, LTM4601A-1 and LTM4601AHV have redundant pads for enhanced solder joint strength to the PCB.



SnPb BGA (Continued)

Function	Input Voltage (V)		Output Voltage (V)		Output Capability per Channel	Isolation Rating	Extended Temp Range	Paralleleable Outputs (Total I _{OUT})**	BGA Package Dimensions (mm)	Part Number
	Min	Max	Min	Max						
Multiple Output Step-Down	6	36	0	24	Five: 1A	Non-Isolated	-55°C to 125°C	×2 (10A)	15 × 15 × 3.42	LTM8001
	3.6	20	1.5	12	Dual: 2A	Non-Isolated	–	×2 (8A)	6.25 × 6.25 × 2.42	LTM4622A
	3.6*	20	0.6	2.5	Dual: 2.5A	Non-Isolated	–	×2 (10A)	6.25 × 6.25 × 2.42	LTM4622
	3.6	15	0.6	2.5	Triple: 3A, 3A, 10mA	Non-Isolated	–	×2 (12A)	6.25 × 6.25 × 2.42	LTM4632
	4*	20	0.6	3.3	Quad: 3A	Non-Isolated	-55°C to 125°C	×1 (12A)	9 × 15 × 2.42	LTM4643
	4.5*	20	0.6	5.5	Dual: 4A	Non-Isolated	–	×1 (8A)	9 × 11.25 × 4.92	LTM4642
	4*	14	0.6	5.5	Quad: 4A	Non-Isolated	-55°C to 125°C	×1 (16A)	9 × 15 × 5.01	LTM4644
	4.75	28	0.8	5.5, 13.5	Triple: 5A, 5A, 4A	Non-Isolated	–	×1 (10A)	15 × 15 × 5.01	LTM4634
	2.7	5.5	0.6	5	Dual: 8A	Non-Isolated	-55°C to 125°C	×2 (32A)	15 × 15 × 3.42	LTM4616
	4.5	26.5	0.6	5.5	Dual: 8A	Non-Isolated	–	×2 (32A)	15 × 15 × 4.92	LTM4628
	4.5	17	0.5	5.5	Dual: 9A	Non-Isolated	–	×4 (72A)	16 × 11.9 × 3.51	LTM4675
	4.5	15	0.6	1.8	Dual: 10	Non-Isolated	–	×2 (40A)	16 × 16 × 2.51	LTM4631
	4.5	20	0.6	5.5	Dual: 10	Non-Isolated	–	×2 (40A)	9 × 15 × 5.01	LTM4646
	4.7*	16	0.8	1.8, 5.5	Triple: 10A	Non-Isolated	-55°C to 125°C	×1 (20A)	15 × 15 × 5.01	LTM4633
	4.5	16	0.6	2.5	Dual: 13A	Non-Isolated	–	×4 (100A)	15 × 15 × 5.01	LTM4620
	4.5	16	0.6	5.3	Dual: 13A	Non-Isolated	–	×4 (100A)	15 × 15 × 5.01	LTM4620A
	4.5	26.5	0.5	5.5	Dual: 13A	Non-Isolated	–	×4 (100A)	16 × 16 × 5.01	LTM4676A
	4.5	15	0.6	1.8	Dual: 18A	Non-Isolated	–	×4 (144A)	16 × 16 × 5.01	LTM4630
	4.5	15	0.6	1.8	Dual: 18A	Non-Isolated	–	×4 (144A)	16 × 16 × 5.01	LTM4630-1
	4.5	16	0.5	1.8	Dual: 18A	Non-Isolated	–	×4 (144A)	16 × 16 × 5.01	LTM4677
4.5	15	0.6	1.8	Dual: 25A	Non-Isolated	–	×6 (300A)	16 × 16 × 5.01	LTM4650	
4.5	15	0.6	1.8	Dual: 25A	Non-Isolated	–	×6 (300A)	16 × 16 × 5.01	LTM4650-1	
4.5	16	0.6	5.5	Dual: 25A	Non-Isolated	–	×6 (300A)	16 × 16 × 5.01	LTM4650A	
Inverting	3.6	58	-0.5	-24	4A	Non-Isolated	–	×2 (8A)	9 × 15 × 5.01	LTM4651

*Can be reduced with external bias supply.

** Number of devices in parallel tested and verified by Analog Devices, Inc..

†In Step-up mode. Output current in step-down mode is approximately 2x greater.

‡LTM4601, LTM4601A, LTM4601HV and LTM4601AHV offer precision remote sense (see page 25). Devices ending with “-1” do not.

‡LTM4601A, LTM4601A-1 and LTM4601AHV have redundant pads for enhanced solder joint strength to the PCB.



Adjustable Loop Compensation

Function	# of Outputs	Input Voltage (V)		Output Voltage (V)		Output Current (A)	V _{OUT} Accuracy (DC)	V _{OUT} Accuracy (AC)	Clock Sync Range (MHz)	Package Dimensions (mm)	Package	Part Number
		Min	Max	Min	Max							
Step-Down	2	4.5	20	0.6	5.5	Dual: 10A	±1.5%	–	0.25 to 1.3	9 × 15 × 5.01	BGA	LTM4646
		4.5	15	0.6	1.8	Dual: 18A	±0.8%	±3%	0.4 to 0.78	16 × 16 × 5.01	BGA	LTM4630-1A
		4.5	15	0.6	1.8	Dual: 18A	±1.5%	±3%	0.4 to 0.78	16 × 16 × 5.01	BGA	LTM4630-1B
		4.5	15	0.6	1.8	Dual: 25A	±0.8%	±3%	0.4 to 0.78	16 × 16 × 5.01	BGA	LTM4650-1A
		4.5	15	0.6	1.8	Dual: 25A	±1.5%	±3%	0.4 to 0.78	16 × 16 × 5.01	BGA	LTM4650-1B
		4.5	16	0.6	5.5	Dual: 25A	±1%	–	0.4 to 0.78	16 × 16 × 5.01	BGA	LTM4650A-1

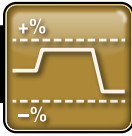

Sequencing & Margining

Function	Input Voltage (V)		Output Voltage (V)		Output Current per Channel (A)	V _{OUT} Margin Up/Down	Output Sequencing	Package Dimensions (mm)	Package	Part Number
	Min	Max	Min	Max						
Step-Down	3.2	40	0.8	15	2 (Continuous) 2.5 (Peak)	–	√	4 × 6.25 × 2.22	BGA	LTM8063
	3.4	40	0.97	18	2.5 (Continuous) 3.5 (Peak)	–	√	6.25 × 6.25 × 2.32	BGA	LTM8065
	4*	20	0.6	5.5	3	–	√	6.25 × 6.25 × 1.82 6.25 × 6.26 × 2.42	LGA BGA	LTM4623
	3.4	60	0.8	24	3 (Continuous) 5 (Peak)	–	√	6.25 × 9 × 3.32	BGA	LTM8073
	3.4	40	0.97	18	3.5 (Continous) 6A (Peak)	–	√	6.25 × 9 × 3.32	BGA	LTM8003
	3.4	40	0.97	15	3.5 (Continus) 6A (Peak)	–	√	6.25 × 9 × 3.32	BGA	LTM8053
	2.375	5.5	0.8	5	4	–	√	9 × 15 × 2.32 9 × 15 × 3.42	LGA BGA	LTM4604A
	4*	14	0.6	5.5	4	–	√	6.25 × 6.25 × 5.01	BGA	LTM4624
	5	36	3.3	15	5	Adjustable	√	15 × 15 × 2.82	LGA	LTM4612
	6	36	0.8	1.8	5	Adjustable	–	15 × 15 × 4.32 15 × 15 × 4.92	LGA BGA	LTM8028
	4*	20	0.6	5.5	5	–	√	6.25 × 6.25 × 5.01	BGA	LTM4625
	4.5	20	0.6	5	6	Adjustable	√	15 × 15 × 2.82	LGA	LTM4603
	4.5	26.5	0.8	5	6	–	√	9 × 15 × 4.32 9 × 15 × 4.92	LGA BGA	LTM4618
	4.5	28	0.6	5	6	Adjustable	√	15 × 15 × 2.82	LGA	LTM4603HV
	4.5	28	0.6	5	6	Adjustable	√	15 × 15 × 2.82 15 × 15 × 3.42	LGA BGA	LTM4606
	2.7	5.5	0.6	5	8	5%, 10%, 15%	√	9 × 15 × 2.82 9 × 15 × 3.42	LGA BGA	LTM4608A
	5	36	3.3	15	8	Adjustable	√	15 × 15 × 4.32 15 × 15 × 4.92	LGA BGA	LTM4613
	4.5	16	0.6	3.3	10	–	√	9 × 15 × 4.92	BGA	LTM4649
	4	38	0.6	6	10	–	√	15 × 15 × 5.01	BGA	LTM4641
	4.5	28	0.6	5	12	Adjustable	√	15 × 15 × 2.82 15 × 15 × 3.42	LGA BGA	LTM4601†
	4.5	20	0.6	5	12	Adjustable	√	15 × 15 × 2.82 15 × 15 × 3.42	LGA BGA	LTM4601-1†
	4.5	20	0.6	5	12	Adjustable	√	15 × 15 × 2.82 15 × 15 × 3.42	LGA BGA	LTM4601A†‡
	4.5	20	0.6	5	12	Adjustable	√	15 × 15 × 2.82 15 × 15 × 3.42	LGA BGA	LTM4601A-1†‡
	4.5	20	0.6	5	12	Adjustable	√	15 × 15 × 2.82 15 × 15 × 3.42	LGA BGA	LTM4601AHV†‡
	4.5	28	0.6	5	12	Adjustable	√	15 × 15 × 2.82 15 × 15 × 3.42	LGA BGA	LTM4601HV†
	1.5	5.5	0.8	5	15	–	√	15 × 15 × 4.32	LGA	LTM4611
	4.5	20	0.6	5	15	–	√	15 × 15 × 4.32 15 × 15 × 4.92	LGA BGA	LTM4627
	4.5	20	0.6	5.5	20	–	√	15 × 15 × 4.32 15 × 15 × 4.92	LGA BGA	LTM4637
	2.375	7	0.6	5.5	20	–	√	15 × 15 × 4.92	BGA	LTM4639
	4.7	15	0.6	1.8	25	–	√	9 × 15 × 3.51	BGA	LTM4645
4.7	15	0.6	1.8	30	–	√	9 × 15 × 5.01	BGA	LTM4647	
4.7	15	0.6	3.3	40	–	√	16 × 16 × 7.07	BGA	LTM4636	

*Can be reduced with external bias supply.
 † LTM4601, LTM4601A, LTM4601HV and LTM4601AHV offer precision remote sense (see page 25). Devices ending with “-1” do not.
 ‡ LTM4601A, LTM4601A-1 and LTM4601AHV have redundant pads for enhanced solder joint strength to the PCB.

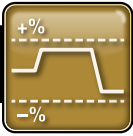

Sequencing & Margining (Continued)

Function	Input Voltage (V)		Output Voltage (V)		Output Current per Channel (A)	V _{OUT} Margin Up/Down	Output Sequencing	Package Dimensions (mm)	Package	Part Number
	Min	Max	Min	Max						
Multiple Output Step-Down	3.6	20	1.5	12	Dual: 2	–	√	6.25 × 6.25 × 1.82 6.25 × 6.25 × 2.42	LGA BGA	LTM4622A
	3.6*	20	0.6	5.5	Dual: 2.5	–	√	6.25 × 6.25 × 1.82 6.25 × 6.25 × 2.42	LGA BGA	LTM4622
	4*	20	0.6	3.3	Quad: 3	–	√	9 × 15 × 1.82 9 × 15 × 2.42	LGA BGA	LTM4643
	2.375	5.5	0.8	5	Dual: 4	–	√	15 × 15 × 2.82	LGA	LTM4614
	4.5	26.5	0.8	5	Dual: 4	–	√	15 × 15 × 2.82	LGA	LTM4619
	4.5*	20	0.6	5.5	Dual: 4	–	√	9 × 11.25 × 4.92	BGA	LTM4642
	2.375	5.5	0.8	5	Triple: 4, 4, 1.5	–	√	15 × 15 × 2.82	LGA	LTM4615
	4*	14	0.6	5.5	Quad: 4	–	√	9 × 15 × 5.01	BGA	LTM4644
	4.75	28	0.8	13.5	Triple: 5, 5, 4	–	√	15 × 15 × 5.01	BGA	LTM4634
	2.7	5.5	0.6	5	Dual: 8	5%, 10%, 15%	√	15 × 15 × 2.82 15 × 15 × 3.42	LGA BGA	LTM4616
	4.5	26.5	0.6	5.5	Dual: 8	–	√	15 × 15 × 4.32 15 × 15 × 4.92	LGA BGA	LTM4628
	4.5	17	0.5	5.5	Dual: 9	Adjustable	√	16 × 11.9 × 3.51	BGA	LTM4675
	4.5	15	0.6	1.8	Dual: 10	–	√	16 × 16 × 1.91 16 × 16 × 2.51	LGA BGA	LTM4631
	4.5	20	0.6	5.5	Dual: 10	–	√	9 × 15 × 5.01	BGA	LTM4646
	4.7*	16	0.8	1.8, 5.5	Triple: 10	–	√	15 × 15 × 5.01	BGA	LTM4633
	4.5	17	0.5	2.75	Dual: 10	Adjustable	√	16 × 16 × 1.82	LGA	LTM4686
	4.5	16	0.6	2.5	Dual: 13	–	√	15 × 15 × 4.41 15 × 15 × 5.01	LGA BGA	LTM4620
	4.5	16	0.6	5.3	Dual: 13	–	√	15 × 15 × 4.41 15 × 15 × 5.01	LGA BGA	LTM4620A
	4.5	26.5	0.5	5.5	Dual: 13	Adjustable	√	16 × 16 × 5.01	BGA	LTM4676A
	4.5	15	0.6	1.8	Dual: 18	–	√	16 × 16 × 4.41 16 × 16 × 5.01	LGA BGA	LTM4630
	4.5	15	0.6	1.8	Dual: 18	–	√	16 × 16 × 5.01	BGA	LTM4630-1
	4.5	15	0.6	5.3	Dual: 18	–	√	16 × 16 × 4.41	LGA	LTM4630A
	4.5	16	0.6	1.8	Dual: 18	Adjustable	√	16 × 16 × 5.01	BGA	LTM4677
	4.5	15	0.6	1.8	Dual: 25	–	√	16 × 16 × 5.01	BGA	LTM4650
	4.5	15	0.6	1.8	Dual: 25	–	√	16 × 16 × 5.01	BGA	LTM4650-1
4.5	16	0.6	5.5	Dual: 25	–	√	16 × 16 × 5.01	BGA	LTM4650A	
4.5	16	0.5	3.3	Dual: 25	Adjustable	√	16 × 16 × 5.74	BGA	LTM4678	

*Can be reduced with external bias supply.

† LTM4601, LTM4601A, LTM4601HV and LTM4601AHV offer precision remote sense (see page 25). Devices ending with “-1” do not.

‡ LTM4601A, LTM4601A-1 and LTM4601AHV have redundant pads for enhanced solder joint strength to the PCB.



Function	# of Outputs	Input Voltage (V)		Output Voltage (V) ¹		Output Current per Current (A)	V _{OUT} Accuracy	Clock Sync Range (MHz)	Package Dimensions (mm)	Package	Part Number
		Min	Max	Min	Max						
Step-Down	1	4.5	20	0.6	3.3	6	±1.5%	0.7 to 1.3	15 × 15 × 2.82	LGA	LTM4603
		4.5	28	0.6	3.3	6	±1.5%	0.7 to 1.3	15 × 15 × 2.82	LGA	LTM4603HV
		4.5	16	0.6	3.3	10	±1.5%	0.3 to 0.8	9 × 15 × 4.92	BGA	LTM4649
		4.5	38	0.6	6	10	±1.5%	–	15 × 15 × 5.01	BGA	LTM4641
		4.5	20	0.6	3.3	12	±1.5%	0.6 to 1.1	15 × 15 × 2.82 15 × 15 × 3.42	LGA BGA	LTM4601
		4.5	20	0.6	3.3	12	±1.5%	0.6 to 1.1	15 × 15 × 2.82 15 × 15 × 3.42	LGA BGA	LTM4601A‡
		4.5	28	0.6	3.3	12	±1.5%	0.6 to 1.1	15 × 15 × 2.82 15 × 15 × 3.42	LGA BGA	LTM4601AHV‡
		4.5	28	0.6	3.3	12	±1.5%	0.6 to 1.1	15 × 15 × 2.82 15 × 15 × 3.42	LGA BGA	LTM4601HV
		1.5	5.5	0.8	3.7	15	±2.0%	0.36 to 0.71	15 × 15 × 4.32	LGA	LTM4611
		4.5	20	0.6	3.3	15	±1.5%	0.4 to 0.8	15 × 15 × 4.32 15 × 15 × 4.92	LGA BGA	LTM4627
		4.5	20	0.6	3.3	20	±1.5%	0.25 to 0.8	15 × 15 × 4.32 15 × 15 × 4.92	LGA BGA	LTM4637
		2.375	7	0.6	5.5	20	±1.5%	0.25 to 0.8	15 × 15 × 4.92	BGA	LTM4639
		4.7	15	0.6	1.8	25	±1.2%	0.3 to 1	9 × 15 × 3.51	BGA	LTM4645
		4.7	15	0.6	1.8	30	±1.2%	0.4 to 0.8	9 × 15 × 5.01	BGA	LTM4647
		4.75	15	0.6	3.3	40	±1.3%	0.25 to 0.8	16 × 16 × 7.12	BGA	LTM4636
		4.75	15	0.6	3.3	40	±1.3%	0.25 to 0.8	16 × 16 × 7.12	BGA	LTM4636-1
		2	4.5	26.5	0.6	3.3	Dual: 8	±1.5%	0.4 to 0.78	15 × 15 × 4.32 15 × 15 × 4.92	LGA BGA
	4.5		17	0.5	5.5	Dual: 9	±0.5%	0.25 to 1.0	16 × 11.9 × 3.51	BGA	LTM4675
	4.5		15	0.6	1.8	Dual: 10	±1.5%	0.55 to 0.75	16 × 16 × 1.91 16 × 16 × 2.51	LGA BGA	LTM4631
	4.5		20	0.6	5.5	Dual: 10	±1.5%	0.25 to 1.3	9 × 15 × 5.01	BGA	LTM4646
	4.5		17	0.5	2.75	Dual: 10	±0.5%	0.25 to 1.3	16 × 16 × 1.82	LGA	LTM4686
	4.5		16	0.6	2.5	Dual: 13	±1.5%	0.4 to 0.78	15 × 15 × 4.41 15 × 15 × 5.01	LGA BGA	LTM4620
	4.5		16	0.6	3.3	Dual: 13	±1.5%	0.4 to 0.78	15 × 15 × 4.41 15 × 15 × 5.01	LGA BGA	LTM4620A
	4.5		16	0.5	5.5	Dual: 13	±0.5%	0.25 to 1.0	16 × 16 × 5.01	BGA	LTM4676A
	4.5		15	0.6	1.8	Dual: 18	±1.5%	0.4 to 0.78	16 × 16 × 4.41 16 × 16 × 5.01	LGA BGA	LTM4630
	4.5		15	0.6	1.8	Dual: 18	±0.8%	0.4 to 0.78	16 × 16 × 5.01	BGA	LTM4630-1A
	4.5		15	0.6	1.8	Dual: 18	±1.5%	0.4 to 0.78	16 × 16 × 5.01	BGA	LTM4630-1B
	4.5	15	0.6	3.3	Dual: 18	±1.5%	0.4 to 0.78	16 × 16 × 4.41	LGA	LTM4630A	
4.5	16	0.5	1.8	Dual: 18	±0.5%	0.225 to 1.1	16 × 16 × 5.01	BGA	LTM4677		
4.5	15	0.6	1.8	Dual: 25	±1.5%	0.4 to 0.78	16 × 16 × 5.01	BGA	LTM4650		
4.5	15	0.6	1.8	Dual: 25	±0.8%	0.4 to 0.78	16 × 16 × 5.01	BGA	LTM4650-1A		
4.5	15	0.6	1.8	Dual: 25	±1.5%	0.4 to 0.78	16 × 16 × 5.01	BGA	LTM4650-1B		
4.5	16	0.6	5.5	Dual: 25	±1%	0.4 to 0.78	16 × 16 × 5.01	BGA	LTM4650A		
4.5	16	0.5	3.3	Dual: 25	±0.5%	0.2 to 1	16 × 16 × 5.74	BGA	LTM4678		

1. When internal remote sense amplifier is in use. See the Step-Down table on page 13 & 14 for maximum output voltage when the remote sense amplifier is not in use.

‡ LTM4601A and LTM4601AHV have redundant pads for enhanced solder joint strength to the PCB.

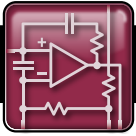

Design and Application Support

Analog Devices provides complete support for μ Module power products including in depth technical information (Application Note and Design Note), design simulation tools, quality and reliability information, packaging information and more.

Application Note (AN) - in depth look at theory, design and applications.

Design Note (DN) - Specific design ideas and circuit tips.

Thermal Performance

- ▶ [AN103](#) - LTM4600 DC/DC μ Module Regulator Thermal Performance
- ▶ [AN110](#) - LTM4601 DC/DC μ Module Regulator Thermal Performance
- ▶ [AN119B](#) - Powering Complex FPGA-Based Systems—Thermal Performance

Electrical Performance

For other design information and applications information, **please refer to the product data sheets** or the following documents:

- ▶ [AN119A](#) - Powering Complex FPGA-Based Systems Using Highly Integrated DC/DC μ Module Regulator Systems
- ▶ [DN385](#) - 10A High Performance Point-of-Load DC/DC μ Module Regulator
- ▶ [DN411](#) - Simple and Compact 4-Output Point-of-Load DC/DC μ Module System
- ▶ [DN430](#) - 8A Low Voltage, Low Profile DC/DC Module Regulator in 9mm \times 15mm Package Weighs Only 1g
- ▶ [DN438](#) - μ Module Buck-Boost Regulators Offer a Simple and Efficient Solution For Wide Input and Output Voltage Range Applications
- ▶ [DN1021](#) - How to Produce Negative Output Voltages from Positive Inputs Using a μ Module Step-Down Regulator
- ▶ [DN530](#) - Increasing Output Voltage and Current Range Using Series - Connected Isolated μ Module Converters
- ▶ [DN551](#) - Ultrathin Triple Output μ Module Regulator for DDR, QDR and QDR-IV SRAM Fits 0.5cm² Area and Backside of PCB
- ▶ [DN569](#) - Cool Running, 144W, 4 \times 40A μ Module POL Regulator
- ▶ [DN1046](#) - 40V Input, 3.5A Silent Switcher μ Module Regulator for Automotive and Industrial Applications

PCB Layout and Assembly

PCB Assembly and Manufacturing Guidelines

[LGA Packages](#): Assembly Considerations for Linear Technology μ Module LGA Packages

[BGA Packages](#): Assembly Considerations for Linear Technology μ Module BGA Packages

Provides a complete guide to:

- ▶ Package Construction
- ▶ PCB Design Guidelines
- ▶ Moisture Sensitivity, Pack, Ship & Bake
- ▶ Board Assembly Process
 - Screen Print
 - Stencil Design
 - Solder Paste, Key Process Parameters
 - Placement
 - Reflow Profile
 - Cleaning
 - Removal and Rework
- ▶ AN117 - DC/DC μ Module Regulator Printed Circuit Board Design Guidelines

CAD Symbols and Footprints

The downloadable zip files contain the schematic symbol and PCB footprint compatible with Mentor Graphics PADS v9.5 or later, and Cadence ORCAD v16.5 or later.

- ▶ [LTM46xx](#) Series
- ▶ [LTM80xx](#) Series

Reliability Data

[Reliability data](#) is available on the web site.

- ▶ [LTM46xx](#) Series
- ▶ [LTM80xx](#) Series

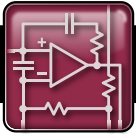

Package Mark Codes

The part number, lot number, date code and final assembly location are marked on the top of the package to facilitate product traceability.

The letter “V” following the part number indicates an LGA package. The letter “Y” indicates a BGA package. The lot number consists of a single letter followed by three to five numbers. The date code consists of four numbers in a YYWW format and is commonly followed by a two letter code indicating the country of final assembly: MY for Malaysia and KR for South Korea. The “e4” or “e1” mark indicates a RoHS compliant package.

For example, the LTM8020 in an LGA package shown is from lot# J447 and was assembled work week 18 of 2009 in Malaysia. The LTM4676A in a BGA package is from lot# 03774 and was assembled work week 14 of 2015 in Malaysia.

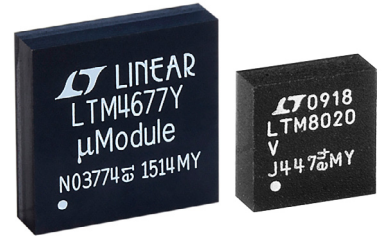

Demonstration Circuits

Demonstration circuits along with associated bill of materials (BoM) and layout Gerber files are available for all products.

Current sharing boards are available for select regulators. Design files are available at: www.linear.com/demo

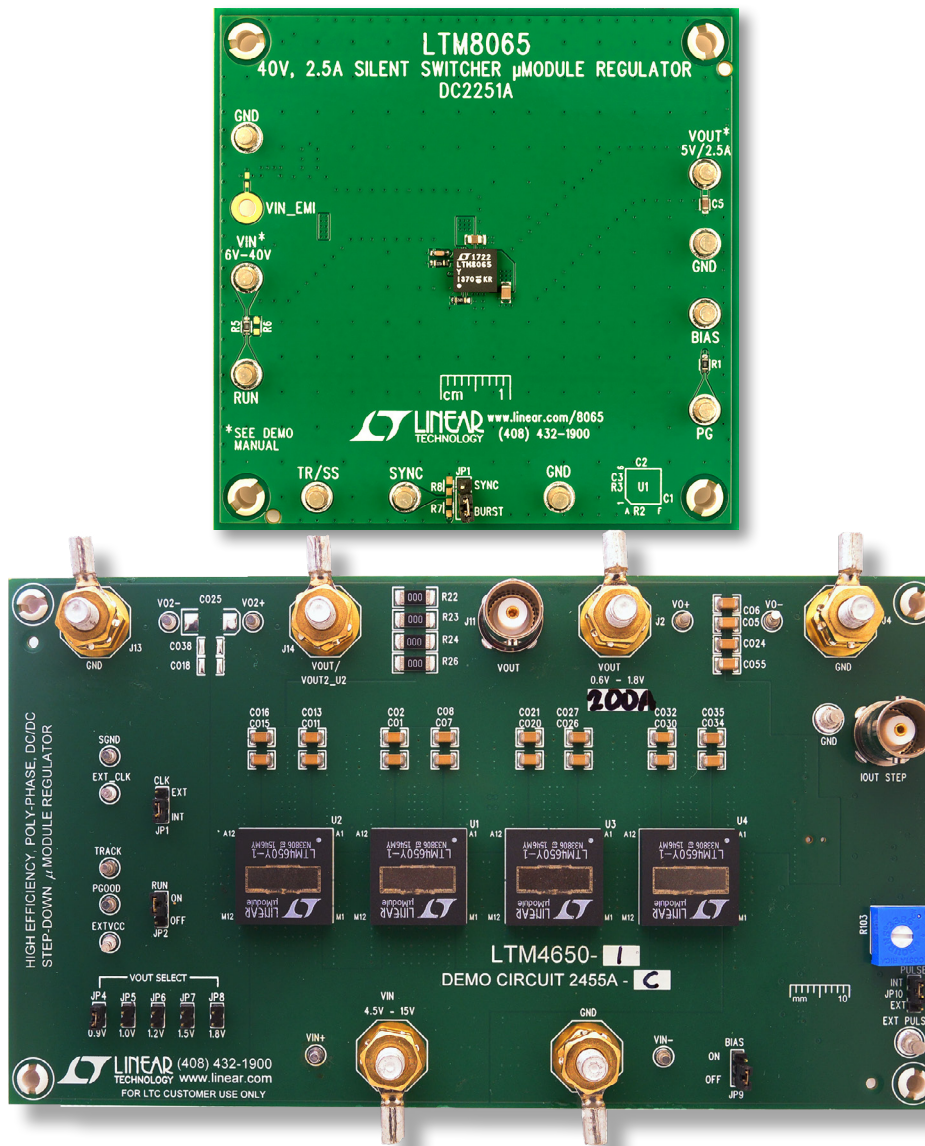

Over 150 unique μmodule demonstration circuit boards

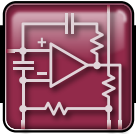

MSL Rating

The Moisture Sensitivity Level (MSL) of μ Module packages is unique to each μ Module device. The MSL of each product is specified in the Order Information section of the data sheet. The MSL is also specified on the shipping box and vacuum sealed bag.

Temperature Grade

μ Module Power Products are offered in E-grade, I-grade, MP-grade or H-grade. Temperature grades are specified in the Order Information section of the product data sheet.

Environmental Compliance

μ Module Power Products in BGA packages with SAC305 solder balls and LGA packages are halogen-free and RoHS compliant. Products are also available in BGA packages with SnPb solder balls. Contact your Analog Devices, Inc. authorized sales representative for details. The materials declaration file for all released products is available at: www.linear.com/umodule. See Order Information section in data sheets.

A sample Order Information table below is from the LTM4650 data sheet. MSL rating, temperature grade and lead finish are described in Order Information section in each data sheet.

ORDER INFORMATION

(<http://www.linear.com/product/LTM4650#orderinfo>)

PART NUMBER	PAD OR BALL FINISH	PART MARKING*		PACKAGE TYPE	MSL RATING	TEMPERATURE RANGE (Note 2)
		DEVICE	FINISH CODE			
LTM4650EY#PBF	SAC305 (RoHS)	LTM4650Y	e1	BGA	3	-40°C to 125°C
LTM4650IY#PBF	SAC305 (RoHS)	LTM4650Y	e1	BGA	3	-40°C to 125°C
LTM4650IY	SnPb (63/37)	LTM4650Y	e0	BGA	3	-40°C to 125°C

Consult Marketing for parts specified with wider operating temperature ranges. *Device temperature grade is indicated by a label on the shipping container. Pad or ball finish code is per IPC/JEDEC J-STD-609.

- Terminal Finish Part Marking: www.linear.com/leadfree
- Recommended LGA and BGA PCB Assembly and Manufacturing Procedures: www.linear.com/umodule/pcbassembly
- LGA and BGA Package and Tray Drawings: www.linear.com/packaging

Shipping Quantity and Tray Information

All μ Module products are shipped in trays with quantities based on package dimensions. For the latest information visit www.linear.com/umodule

Trays for BGA Devices			Trays for LGA Devices		
15mm × 9mm	50-8028	1.54mm - 2.82mm Package Height, 170 parts per tray	4mm × 4mm	50-8020	0.94mm Package Height, 540 parts per tray
11.25mm × 6.25mm	50-8050	4.32mm Package Height, 273 parts per tray	15mm × 15mm	50-8023	2.82mm Package Height, 119 parts per tray
15mm × 11.25mm	50-8052	2.82mm - 3.42mm Package Height, 119 parts per tray	15mm × 9mm	50-8028	2.32mm - 2.82mm Package Height, 170 parts per tray
11.25mm × 15mm	50-8062	4.32mm - 4.92mm Package Height, 119 parts per tray	11.25mm × 6.25mm	50-8036	2.82mm Package Height, 273 parts per tray
9mm × 11.25mm	50-8064	2.72mm Package Height, 210 parts per tray	11.25mm × 11.25mm	50-8038	2.32mm Package Height, 168 parts per tray
9mm × 11.25mm	50-8066	3.42mm - 4.92mm Package Height, 168 parts per tray	6.25mm × 6.25mm	50-8040	2.32mm Package Height, 260 parts per tray
15mm × 15mm	50-8068	4.92mm - 5.02mm Package Height, 119 parts per tray	11.25mm × 9mm	50-8042	2.82mm Package Height, 210 parts per tray
15mm × 15mm	50-8072	2.82mm - 4.92mm Package Height, 119 parts per tray	15mm × 11.25mm	50-8044	2.32mm Package Height, 119 parts per tray
15mm × 9mm	50-8074	3.42mm - 5.01mm Package Height, 170 parts per tray	15mm × 15mm	50-8046	4.32mm - 4.41mm Package Height, 119 parts per tray
11.25mm × 6.25mm	50-8076	4.92mm Package Height, 273 parts per tray	15mm × 9mm	50-8048	4.32mm Package Height, 170 parts per tray
16mm × 16mm	50-8078	5.01mm Package Height, 90 parts per tray	11.25mm × 6.25mm	50-8050	3.42mm - 4.32mm Package Height, 273 parts per tray
6.25mm × 6.25mm	50-8084	5.01mm Package Height, 260 parts per tray	15mm × 11.25mm	50-8052	2.82mm Package Height, 119 parts per tray
6.25mm × 9mm	50-8086	2.91mm Package Height, 260 parts per tray	11.25mm × 15mm	50-8062	4.32mm - 4.92mm Package Height, 119 parts per tray
11.9mm × 16mm	50-8090	3.01mm - 5.01mm Package Height, 112 parts per tray	16mm × 16mm	50-8078	4.41mm Package Height, 90 parts per tray

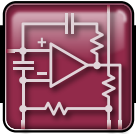

Power Management for FPGAs and Processors

Power management solutions presented on www.linear.com/FPGA and the Power Management Solutions for FPGAs brochure have been assembled and verified by Altera®, Xilinx®, NXP® or third-party development board providers. Each solution is accompanied by a photo of the board, power tree and its Analog Devices, Inc. bill-of-materials.

www.linear.com/FPGA

Tested and Verified Power Management Solution for Altera and Xilinx FPGA Boards

Schematics
Bill-of-Material
Power Circuit Simulation & Design Tools

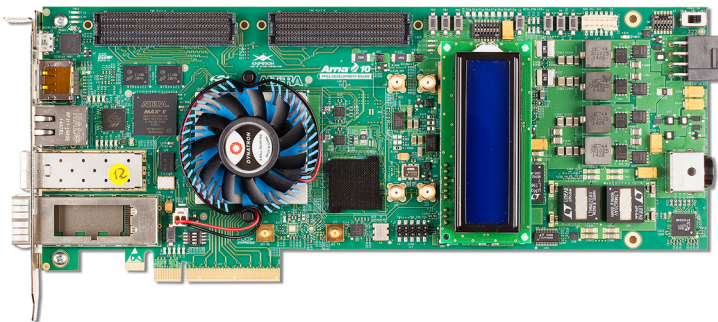

Altera Arria 10 GX FPGA Development Kit

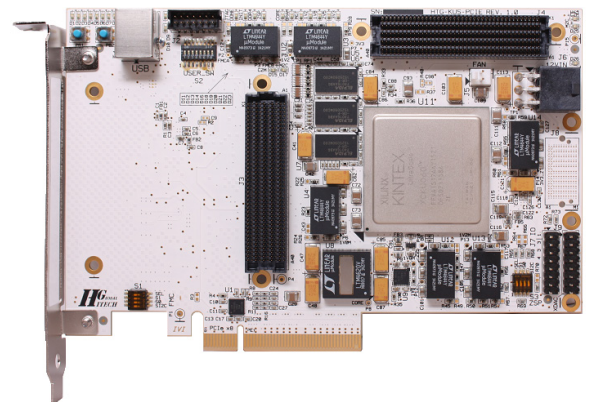

Xilinx Kintex Ultrascale PCI Express Platform
(by HiTech Global)

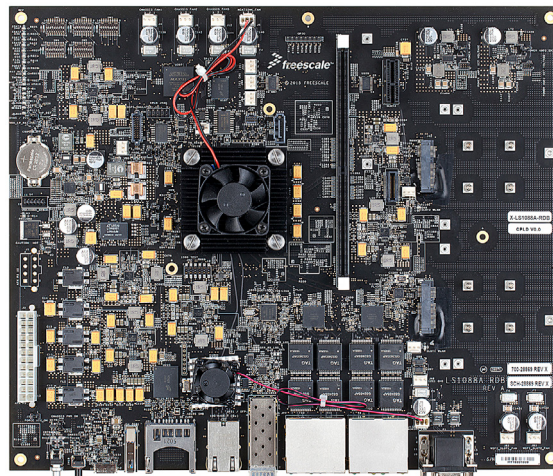

QorIQ LS1088A Reference Design Board

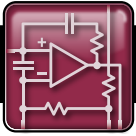

Design Support

Analog Devices, Inc. offers free simulation design tools to shorten your design time and optimize your power supply solution before you build your prototype board.

LTpowerCAD II

LTpowerCAD® is a free download and easy-to-use power supply design tool with a user-friendly graphical user interface (GUI) and powerful design features. It helps power supply designers select a solution for given supply specifications, design power stage components, estimate regulator efficiency and power loss, and optimize supply loop stability and load transient performance. It is a fast offline tool that runs on Windows PCs, and includes a sync-release feature to ensure that your program and its solution libraries are up-to-date. Once a circuit design is completed, it is easily exported to the LTspice simulation platform. Inside the LTpowerCAD toolbox, there is also an [LTpowerPlanner](#) system architecture tool for system-level power management design and optimization.

LTpowerPlanner

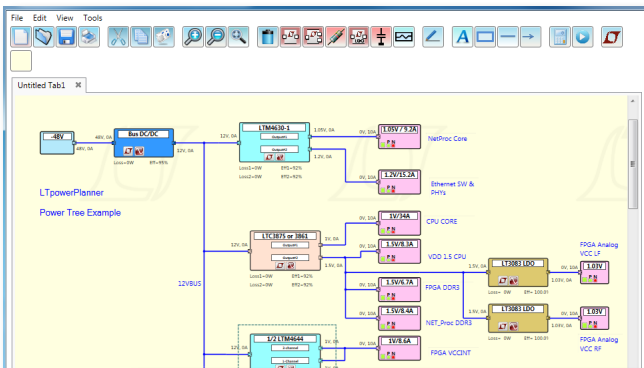

System Architecture and Plan

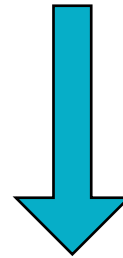

Search and Selection

LTpowerCAD

The interface shows converter specifications (12V input, 1V output, 5A) and optional features like synchronous FET and remote voltage sensing. A table lists various regulator models:

Design Tool	Website	Part Name	Type	Desc.	Topology	Max Vin	Min Vin
LTC	LTC Web	LTM4625	uModule	14VIN, 5A Step-Down DC/DC uModule Regulator	Buck	20	4
LTC	LTC Web	LTM4649	uModule	16V Single 10A Step Down DC/DC uModule Regulator	Buck	16	4.5
LTC	LTC Web	LTM4603-1	uModule	6A Step Down uModule Regulator. Use LTM4618 for new designs.	Buck	20	4.5
LTC	LTC Web	LTM4603	uModule	6A Step uModule Regulator with PLL Output Margining. Use LTM4618 for new designs.	Buck	20	4.5

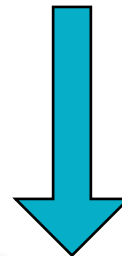

Circuit Parametric Design

The interface shows a detailed circuit diagram for an LTM4602 regulator. It includes input/output specifications, component values (C_{in}, C_{comp}, C_b, C_{ce}), and a table of capacitor parameters:

Part #	C	ESR	ESL	# of Cb
MFR	150 µF	9 mΩ	1.6 nH	1
MFR	330 µF	2 mΩ	1.2 nH	1
MFR	100 µF	2 mΩ	1.2 nH	2

It also displays a table for compensation components:

Parameter	Value
C _{ref}	82 pF
V _{in}	12.65 V
I _o	0.00 A
C _p	0 pF
Each C _{comp}	150 pF

Additional metrics shown include: Inductor peak current = 5.91 A, Actual voltage loop bandwidth = 19.00 kHz, and Actual voltage loop phase margin = 47.48 deg.

Two graphs are provided: Voltage Loop Gain (Magnitude and Phase vs Frequency) and Output Impedance (Magnitude and Phase vs Frequency).

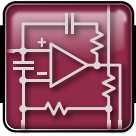

LTspice

LTspice is a free, simple and powerful circuit simulation tool with a library containing Analog Devices, Inc. products, as well as commonly used discrete passive and transistor components.

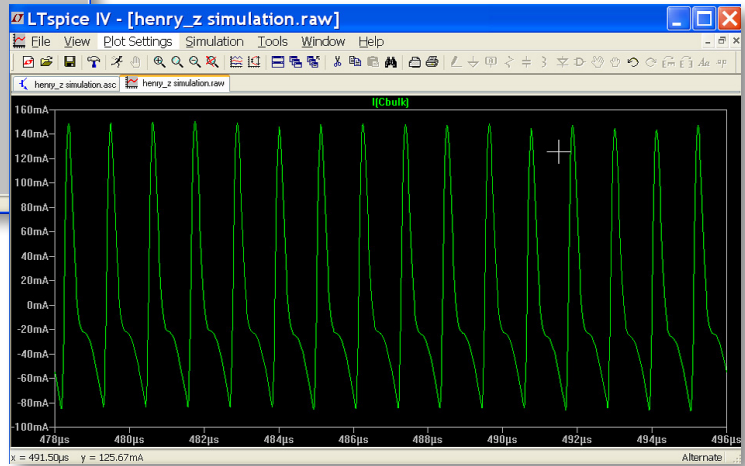
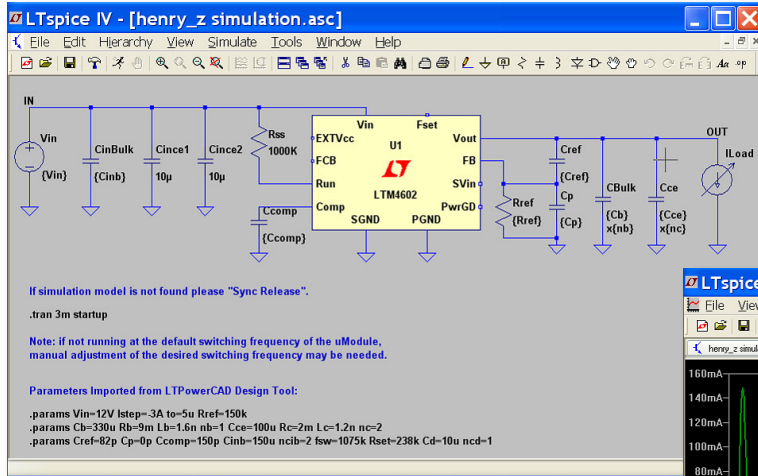

LTpowerPlay

LTpowerPlay® is an intuitive Windows-based development environment used to configure and interrogate power system management (PSM) devices. It can also be used in an offline mode (with no hardware present) in order to build a multichip configuration file that can be saved and reloaded at a later time.

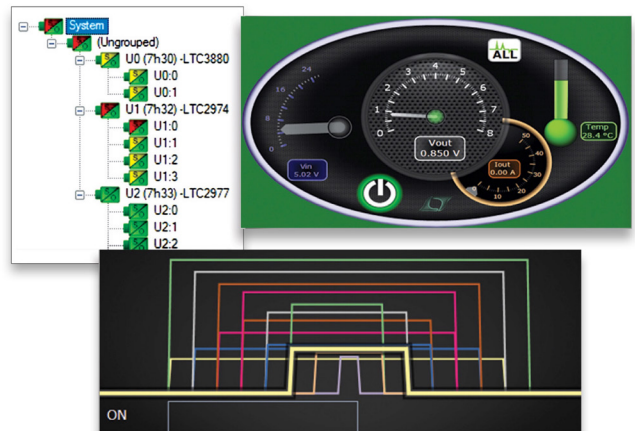
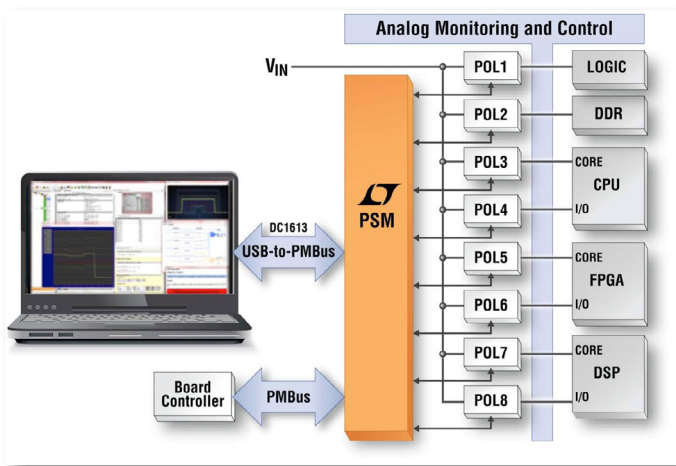

BIG VOLTS SMALL PACKAGE

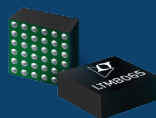

DC/DC Function	Part #	V _{IN} Range	Max V _{IN}	V _{OUT} Range	I _{OUT}	BGA Package Relative Size (mm)	
Step-Down	LTM8065	3.4V to 40V	42V	0.97V to 18V	2.5A (Continuous) 3.5A (Peak)	6.25 x 6.25 x 2.32	■
	LTM8053	3.4V to 40V	42V	0.97V to 15V	3.5A (Continuous) 6A (Peak)	6.25 x 9 x 3.32	■
	LTM8073	3.4V to 60V	65V	0.8V to 15V	3A (Continuous) 5A (Peak)		
Step-Down: Constant Current Constant Voltage	LTM8064	6V to 58V	60V	1.2V to 36V	6A (Sink & Source)	11.9 x 16 x 4.92	■
Step-Down: FMEA Compliant & 150°C Operation	LTM8003	3.4V to 40V	42V	0.97V to 18V	3.5A (Continuous) 6A (Peak)	6.25 x 9 x 3.32	■
Inverting	LTM4651	3.6V to 58V	60V	-0.5V to -26.5V	Up to 4A	9 x 15 x 5.01	■
Buck-Boost (V _{IN} < V _{OUT} or V _{IN} > V _{OUT} or V _{IN} = V _{OUT})	LTM8054	5V to 36V	40V	1.2V to 36V	5.4A	11.25 x 15 x 3.42	■
	LTM8055	5V to 36V	40V	1.2V to 36V	8.5A	15 x 15 x 4.92	■
	LTM8056	5V to 58V	60V	1.2V to 48V	5.4A		

Analog Devices, Inc. Worldwide Headquarters

Analog Devices, Inc.
One Technology Way
P.O. Box 9106
Norwood, MA 02062-9106
U.S.A.
Tel: 781.329.4700
(800.262.5643, U.S.A. only)
Fax: 781.461.3113

Analog Devices, Inc. Europe Headquarters

Analog Devices GmbH
Otli-Aicher-Str. 60-64
80807 München
Germany
Tel: 49.89.76903.0
Fax: 49.89.76903.157

Analog Devices, Inc. Japan Headquarters

Analog Devices, KK
New Pier Takeshiba
South Tower Building
1-16-1 Kaigan, Minato-ku,
Tokyo, 105-6891
Japan
Tel: 813.5402.8200
Fax: 813.5402.1064

Analog Devices, Inc. Asia Pacific Headquarters

Analog Devices
5F, Sandhill Plaza
2290 Zuchongzhi Road
Zhangjiang Hi-Tech Park
Pudong New District
Shanghai, China 201203
Tel: 86.21.2320.8000
Fax: 86.21.2320.8222

©2018 Analog Devices, Inc. All rights reserved. Trademarks and registered trademarks are the property of their respective owners. Ahead of What's Possible is a trademark of Analog Devices. BRμmodulePP/3/18(H)

analog.com and linear.com

