

MAXIM

GSM900及びDCS1800/PCS1900 デュアルバンド、低ノイズアンプ

MAX2651/MAX2652/MAX2653

概要

MAX2651/MAX2652/MAX2653は、GSM900、DCS1800及びPCS1900バンドワイヤレスハンドセット用のシリコンゲルマニウム(SiGe)低ノイズアンプ(LNA)です。MAX2651/MAX2652は2つのLNAから構成されており、一方はGSM900バンド用に、他方はDCS1800/PCS1900バンド用に最適化されています。また、2つのLNA間を切替えるためのバンド選択ピン、及び各LNAの利得を20dB低減して消費電流を低減するための利得ステップ入力を備えています。MAX2652はMAX2651と機能的には同等ですが、低電力シャットダウンモードを備えています。MAX2653はDCS1800及びPCS1900バンド用に最適化された1つのLNAからなっており、シャットダウン機能及び20dB利得ステップを備えています。

MAX2652とMAX2653を組み合わせると、トリプルバンド電話のアプリケーション(GSM、DCS及びPCSバンド)に理想的なソリューションとなります。

MAX2651/MAX2652/MAX2653は、先進技術の高周波SiGeバイポーラプロセスで製造されています。このため、いずれの素子もGSM、DCS及びPCSバンドにおいて低雑音指数、高利得及び高入力3次インターセプトポイント(IP3)性能を備えています。各LNAの出力とV_{CC}の間のプルアップ抵抗により、利得を調整できます。入力及び出力マッチングに必要な外付部品点数が最小限であるため、基板スペースが削減できます。

MAX2651/MAX2652は10ピンµMAX、MAX2653は8ピンµMAXパッケージで提供されています。いずれの素子も+2.7V~+3.3Vの単一電源で動作します。

アプリケーション

GSM900/DCS1800デュアルバンド電話

GSM900/DCS1800/PCS1900トリプルバンド電話

DCS1800又はPCS1900シングルモード電話

IS-136 TDMAデュアルバンド電話

特長

- ◆ 広動作周波数範囲
800MHz~1000MHz(MAX2651/52)
1800MHz~2000MHz(MAX2651/52/53)
- ◆ 優れた低ノイズ性能
GSM受信バンドで1.2dB/1.3dB
(MAX2651/52)
DCS受信バンドで1.8dB/1.8dB/1.7dB
(MAX2651/52/53)
- ◆ 高利得
GSM受信バンドで18dB(MAX2651/52)
DCS受信バンドで18dB/17.5dB/18.5dB
(MAX2651/52/53)
- ◆ 低利得モードで利得が20dB低減
- ◆ 利得は外部調整可能
- ◆ 電源：+2.7V~+3.3V単一
- ◆ 低消費電流
5.4mA~7.0mA(高利得モード)
2.2mA(低利得モード)
- ◆ シャットダウン電流：0.25µA(MAX2652/53)

型番

PART	TEMP. RANGE	PIN-PACKAGE
MAX2651EUB	-40°C to +85°C	10 µMAX
MAX2652EUB	-40°C to +85°C	10 µMAX
MAX2653EUA	-40°C to +85°C	8 µMAX

ピン配置/ファンクションダイアグラム

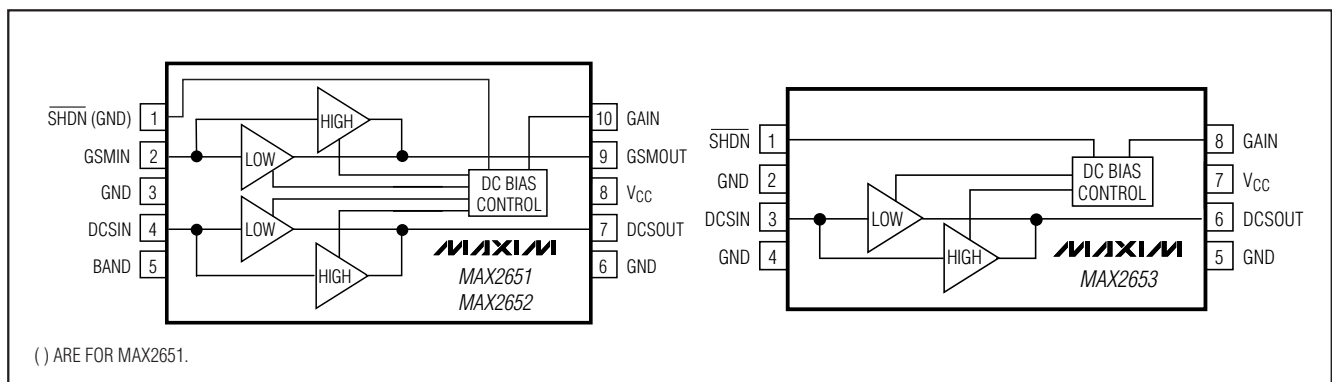

MAXIM

Maxim Integrated Products 1

本データシートに記載された内容はMaxim Integrated Productsの公式な英語版データシートを翻訳したものです。翻訳により生じる相違及び誤りについては責任を負いかねます。正確な内容の把握には英語版データシートをご参照ください。

無料サンプル及び最新版データシートの入手には、マキシムのホームページをご利用ください。http://japan.maxim-ic.com

GSM900及びDCS1800/PCS1900 デュアルバンド、低ノイズアンプ

MAX2651/MAX2652/MAX2653

ABSOLUTE MAXIMUM RATINGS

V_{CC} to GND	-0.3V to +6V	10-Pin μ MAX (derate 5.6mW/°C above +70°C)	444mW
$\overline{\text{SHDN}}$, GAIN, BAND to GND	-0.3V to (V_{CC} + 0.3V)	Operating Temperature Range	-40°C to +85°C
GSMIN, DCSIN	1.0V peak (+10dBm)	Junction Temperature	+150°C
Input Current (all digital inputs)	± 10 mA	Storage Temperature Range	-65°C to +150°C
Continuous Power Dissipation		Lead Temperature (soldering, 10s)	+300°C
8-Pin μ MAX (derate 4.5mW/°C above +70°C)	362mW		

Stresses beyond those listed under "Absolute Maximum Ratings" may cause permanent damage to the device. These are stress ratings only, and functional operation of the device at these or any other conditions beyond those indicated in the operational sections of the specifications is not implied. Exposure to absolute maximum rating conditions for extended periods may affect device reliability.

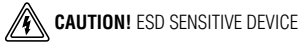

DC ELECTRICAL CHARACTERISTICS—MAX2651

(V_{CC} = +2.7V to +3.3V, BAND = GAIN = V_{CC} , no input signal, all input/output ports terminated in 50 Ω , T_A = -40°C to +85°C, unless otherwise noted. Typical values are at V_{CC} = +3V, T_A = +25°C.) (Note 1)

PARAMETER	SYMBOL	CONDITIONS	MIN	TYP	MAX	UNITS
Input Voltage Range	V_{CC}		2.7		3.3	V
Input Supply Current	I_{CC}	DCS band, high-gain mode (BAND = GAIN = V_{CC})		5.7	8.7	mA
		DCS band, low-gain mode (BAND = V_{CC} , GAIN = GND)		2.2	3.3	
		GSM band, high-gain mode (BAND = GND, GAIN = V_{CC})		5.9	9.6	
		GSM band, low-gain mode (BAND = GND, GAIN = V_{CC})		2.2	3.6	
Input Logic Threshold High	V_{IH}				1.5	V
Input Logic Threshold Low	V_{IL}		0.5			V
Input Logic High Current	I_{IH}	$V_{IN} = V_{CC}$			1.5	μ A
Input Logic Low Current	I_{IL}	$V_{IN} = \text{GND}$	-1.5			μ A

DC ELECTRICAL CHARACTERISTICS—MAX2652

(V_{CC} = +2.7V to +3.3V, BAND = GAIN = V_{CC} , no input signal, all input/output ports terminated in 50 Ω , T_A = -40°C to +85°C, unless otherwise noted. Typical values are at V_{CC} = +3V, T_A = +25°C.) (Note 1)

PARAMETER	SYMBOL	CONDITIONS	MIN	TYP	MAX	UNITS
Input Voltage Range	V_{CC}		2.7		3.3	V
Input Supply Current	I_{CC}	DCS band, high-gain mode (BAND = GAIN = V_{CC})		7.0	11.0	mA
		DCS band, low-gain mode (BAND = V_{CC} , GAIN = GND)		2.3	3.6	
		GSM band, high-gain mode (BAND = GND, GAIN = V_{CC})		7.2	11.0	
		GSM band, low-gain mode (BAND = GND, GAIN = V_{CC})		2.4	3.7	
Shutdown Supply Current		$\overline{\text{SHDN}} = \text{GND}$		0.25		μ A

GSM900及びDCS1800/PCS1900 デュアルバンド、低ノイズアンプ

MAX2651/MAX2652/MAX2653

DC ELECTRICAL CHARACTERISTICS—MAX2653

($V_{CC} = +2.7V$ to $+3.3V$, $\overline{SHDN} = GAIN = V_{CC}$, no input signal, all input/output ports terminated in 50Ω , $T_A = -40^\circ C$ to $+85^\circ C$, unless otherwise noted. Typical values are at $V_{CC} = +3V$, $T_A = +25^\circ C$.) (Note 1)

PARAMETER	SYMBOL	CONDITIONS	MIN	TYP	MAX	UNITS
Input Logic Threshold High	V_{IH}				1.5	V
Input Logic Threshold Low	V_{IL}		0.5			V
Input Logic High Current	I_{IH}	$V_{IN} = V_{CC}$			1.5	μA
Input Logic Low Current	I_{IL}	$V_{IN} = GND$	-1.5			μA
Input Voltage Range	V_{CC}		2.7		3.3	V
Input Supply Current	I_{CC}	DCS band, high-gain mode ($GAIN = V_{CC}$)		5.4	8.5	mA
		DCS band, low-gain mode ($GAIN = GND$)		2.2	3.2	
Shutdown Supply Current	I_{SHDN}	$\overline{SHDN} = GND$		0.25		μA
Input Logic Threshold High	V_{IH}				1.5	V
Input Logic Threshold Low	V_{IL}		0.5			V
Input Logic High Current	I_{IH}	$V_{IN} = V_{CC}$			3	μA
Input Logic Low Current	I_{IL}	$V_{IN} = GND$	-1.5			μA

Note 1: Devices are production tested at $T_A = +25^\circ C$. Minimum and maximum limits are guaranteed by design and characterization.

AC ELECTRICAL CHARACTERISTICS—MAX2651

(MAX2651 EV kit, $f_{IN} = 945MHz$ (GSM band), $f_{IN} = 1850MHz$ (DCS band), $P_{IN} = -30dBm$, input and output matching networks are optimized for the frequency band of interest, all input/output ports terminated in 50Ω , $V_{CC} = +3V$, $T_A = +25^\circ C$, unless otherwise noted.) (Note 2)

PARAMETER	SYMBOL	CONDITIONS	MIN	TYP	MAX	UNITS	
Input Frequency Range (Note 3)	f_{IN}	DCS band ($BAND = V_{CC}$)	1805		1880	MHz	
		GSM band ($BAND = GND$)	925		960		
Power Gain (Note 4)	G	DCS band, high-gain mode ($BAND = GAIN = V_{CC}$)	$T_A = +25^\circ C$	16.5	18	19.5	dB
			$T_A = -40^\circ C$ to $+85^\circ C$	16		20	
		DCS band, low-gain mode ($BAND = V_{CC}$, $GAIN = GND$)	$T_A = +25^\circ C$	-3.5	-2	-0.5	
			$T_A = -40^\circ C$ to $+85^\circ C$	-4		0	
		GSM band, high-gain mode ($BAND = GND$, $GAIN = V_{CC}$)	$T_A = +25^\circ C$	16.5	18	19.5	
			$T_A = -40^\circ C$ to $+85^\circ C$	16		20	
GSM band, low-gain mode ($BAND = GAIN = GND$)	$T_A = +25^\circ C$	-3.5	-2	-0.5			
	$T_A = -40^\circ C$ to $+85^\circ C$	-4		0			
Noise Figure (Note 4)	NF	DCS band, high-gain mode ($BAND = GAIN = V_{CC}$)		1.8	2.05	dB	
		DCS band, low-gain mode ($BAND = V_{CC}$, $GAIN = GND$)		5.5	6.0		
		GSM band, high-gain mode ($BAND = GND$, $GAIN = V_{CC}$)		1.2	1.4		
		GSM band, low-gain mode ($BAND = GAIN = GND$)		5.3	6.7		

GSM900及びDCS1800/PCS1900 デュアルバンド、低ノイズアンプ

MAX2651/MAX2652/MAX2653

AC ELECTRICAL CHARACTERISTICS—MAX2651 (continued)

(MAX2651 EV kit, $f_{IN} = 945\text{MHz}$ (GSM band), $f_{IN} = 1850\text{MHz}$ (DCS band), $P_{IN} = -30\text{dBm}$, input and output matching networks are optimized for the frequency band of interest, all input/output ports terminated in 50Ω , $V_{CC} = +3\text{V}$, $T_A = +25^\circ\text{C}$, unless otherwise noted.) (Note 2)

PARAMETER	SYMBOL	CONDITIONS	MIN	TYP	MAX	UNITS
Input Third-Order Intercept Point	IIP3	(Note 5) DCS band, high-gain mode (BAND = GAIN = V_{CC})	-11.5	-10		dBm
		DCS band, low-gain mode (BAND = V_{CC} , GAIN = GND)	-1.5	0.5		
		(Note 6) GSM band, high-gain mode (BAND = GND, GAIN = V_{CC})	-10.5	-8.5		
		GSM band, low-gain mode (BAND = GND, GAIN = GND)	-2.5	0.5		
Input 1dB Compression Point	IP-1dB	DCS band, high-gain mode (BAND = GAIN = V_{CC})	-20	-18		dBm
		DCS band, low-gain mode (BAND = V_{CC} , GAIN = GND)	-9.5	-8		
		GSM band, high-gain mode (BAND = GND, GAIN = V_{CC})	-20	-18		
		GSM band, low-gain mode (BAND = GND, GAIN = GND)	-10.5	-8.5		
Input Return Loss	$ S_{11} ^2$	DCS band, high-gain mode (BAND = GAIN = V_{CC})		-11	-8.5	dB
		DCS band, low-gain mode (BAND = V_{CC} , GAIN = GND)		-14	-12	
		GSM band, high-gain mode (BAND = GND, GAIN = V_{CC})		-11	-8.5	
		GSM band, low-gain mode (BAND = GAIN = GND)		-20	-15	
Output Return Loss	$ S_{22} ^2$	DCS band, high-gain mode (BAND = GAIN = V_{CC})		-14	-10	dB
		DCS band, low-gain mode (BAND = V_{CC} , GAIN = GND)		-12	-10	
		GSM band, high-gain mode (BAND = GND, GAIN = V_{CC})		-19	-15	
		GSM band, low-gain mode (BAND = GAIN = GND)		-20	-15	
Reverse Isolation	$ S_{12} ^2$	DCS band, high-gain mode (BAND = GAIN = V_{CC})		-32	-29	dB
		DCS band, low-gain mode (BAND = V_{CC} , GAIN = GND)		-20	-18	
		GSM band, high-gain mode (BAND = GND, GAIN = V_{CC})		-39	-35	
		GSM band, low-gain mode (BAND = GAIN = GND)		-22	-20	

GSM900及びDCS1800/PCS1900 デュアルバンド、低ノイズアンプ

MAX2651/MAX2652/MAX2653

AC ELECTRICAL CHARACTERISTICS—MAX2652

(MAX2652 EV kit, $f_{IN} = 945\text{MHz}$ (GSM band), $f_{IN} = 1850\text{MHz}$ (DCS band), $P_{IN} = -30\text{dBm}$, input and output matching networks are optimized for the frequency band of interest, all input/output ports terminated in 50Ω , $V_{CC} = +3\text{V}$, $T_A = +25^\circ\text{C}$, unless otherwise noted.) (Note 2)

PARAMETER	SYMBOL	CONDITIONS		MIN	TYP	MAX	UNITS
Input Frequency Range (Note 3)	f_{IN}	DCS band (BAND = V_{CC})		1805		1880	MHz
		GSM band (BAND = GND)		925		960	
Power Gain (Note 4)	G	DCS band, high-gain mode (BAND = GAIN = V_{CC})	$T_A = +25^\circ\text{C}$	16	17.5	19	dB
			$T_A = -40^\circ\text{C}$ to $+85^\circ\text{C}$	15.5		19.5	
		DCS band, low-gain mode (BAND = V_{CC} , GAIN = GND)	$T_A = +25^\circ\text{C}$	-3.5	-2	-0.5	
			$T_A = -40^\circ\text{C}$ to $+85^\circ\text{C}$	-4		0	
		GSM band, high-gain mode (BAND = GND, GAIN = V_{CC})	$T_A = +25^\circ\text{C}$	16.5	18	19.5	
			$T_A = -40^\circ\text{C}$ to $+85^\circ\text{C}$	16		20	
GSM band, low-gain mode (BAND = GAIN = GND)	$T_A = +25^\circ\text{C}$	-4.0	-2	-0.5			
	$T_A = -40^\circ\text{C}$ to $+85^\circ\text{C}$	-4.5		0			
Noise Figure (Note 4)	NF	DCS band, high-gain mode (BAND = GAIN = V_{CC})			1.8	2.0	dB
		DCS band, low-gain mode (BAND = V_{CC} , GAIN = GND)			5.8	6.3	
		GSM band, high-gain mode (BAND = GND, GAIN = V_{CC})			1.3	1.5	
		GSM band, low-gain mode (BAND = GAIN = GND)			5.5	6.7	
Input Third-Order Intercept Point	IIP3	(Note 5)	DCS band, high-gain mode (BAND = GAIN = V_{CC})	-8.5	-7	dBm	
			DCS band, low-gain mode (BAND = V_{CC} , GAIN = GND)	0	1.5		
		(Note 6)	GSM band, high-gain mode (BAND = GND, GAIN = V_{CC})	-9	-7.5		
			GSM band, low-gain mode (BAND = GND, GAIN = GND)	0.5	2.5		
Input 1dB Compression Point	IP-1dB	DCS band, high-gain mode (BAND = GAIN = V_{CC})		-18	-16.5	dBm	
		DCS band, low-gain mode (BAND = V_{CC} , GAIN = GND)		-10.5	-8		
		GSM band, high-gain mode (BAND = GND, GAIN = V_{CC})		-18	-16.5		
		GSM band, low-gain mode (BAND = GND, GAIN = GND)		-10	-8.5		

GSM900及びDCS1800/PCS1900 デュアルバンド、低ノイズアンプ

MAX2651/MAX2652/MAX2653

AC ELECTRICAL CHARACTERISTICS—MAX2652 (continued)

(MAX2652 EV kit, $f_{IN} = 945\text{MHz}$ (GSM band), $f_{IN} = 1850\text{MHz}$ (DCS band), $P_{IN} = -30\text{dBm}$, input and output matching networks are optimized for the frequency band of interest, all input/output ports terminated in 50Ω , $V_{CC} = +3\text{V}$, $T_A = +25^\circ\text{C}$, unless otherwise noted.) (Note 2)

PARAMETER	SYMBOL	CONDITIONS	MIN	TYP	MAX	UNIT
Input Return Loss	$ S_{11} ^2$	DCS band, high-gain mode (BAND = GAIN = V_{CC})		-12	-9.5	dB
		DCS band, low-gain mode (BAND = V_{CC} , GAIN = GND)		-12	-9.5	
		GSM band, high-gain mode (BAND = GND, GAIN = V_{CC})		-11	-9.5	
		GSM band, low-gain mode (BAND = GAIN = GND)		-20	-15	
Output Return Loss	$ S_{22} ^2$	DCS band, high-gain mode (BAND = GAIN = V_{CC})		-11	-9.5	dB
		DCS band, low-gain mode (BAND = V_{CC} , GAIN = GND)		-17	-13	
		GSM band, high-gain mode (BAND = GND, GAIN = V_{CC})		-12.5	-11	
		GSM band, low-gain mode (BAND = GAIN = GND)		-15	-13	
Reverse Isolation	$ S_{12} ^2$	DCS band, high-gain mode (BAND = GAIN = V_{CC})		-29	-26	dB
		DCS band, low-gain mode (BAND = V_{CC} , GAIN = GND)		-19	-17	
		GSM band, high-gain mode (BAND = GND, GAIN = V_{CC})		-37	-34	
		GSM band, low-gain mode (BAND = GAIN = GND)		-23	-20	

GSM900及びDCS1800/PCS1900 デュアルバンド、低ノイズアンプ

MAX2651/MAX2652/MAX2653

AC ELECTRICAL CHARACTERISTICS—MAX2653

(MAX2653 EV kit, $f_{IN} = 1850\text{MHz}$ (DCS band), $f_{IN} = 1960\text{MHz}$ (PCS band), $P_{IN} = -30\text{dBm}$, input and output matching networks are optimized for the frequency band of interest, all input/output ports terminated in 50Ω , $V_{CC} = +3\text{V}$, $T_A = +25^\circ\text{C}$, unless otherwise noted.) (Note 2)

PARAMETER	SYMBOL	CONDITIONS		MIN	TYP	MAX	UNITS
Input Frequency Range (Note 3)	f_{IN}	BAND = V_{CC}	DCS band	1805		1880	MHz
			PCS band	1930		1990	
Power Gain (Note 4)	G	DCS and PCS band, high-gain mode (BAND = GAIN = V_{CC})	$T_A = +25^\circ\text{C}$	17	18.5	20	dB
			$T_A = -40^\circ\text{C}$ to $+85^\circ\text{C}$	16		20	
		DCS and PCS band, low-gain mode (BAND = V_{CC} , GAIN = GND)	$T_A = +25^\circ\text{C}$	-4	-2.5	-1	
			$T_A = -40^\circ\text{C}$ to $+85^\circ\text{C}$	-4		0	
Noise Figure (Note 4)	NF	High-gain mode (BAND = GAIN = V_{CC})	DCS band		1.7	1.9	dB
			PCS band		1.8	2.05	
		DCS and PCS band, low-gain mode (BAND = V_{CC} , GAIN = GND)			5.3	6.7	
Input Third-Order Intercept Point (Notes 5, 7)	IIP3	DCS and PCS band, high-gain mode (BAND = V_{CC} , GAIN = GND)		-10.5	-8.5		dBm
		DCS and PCS band, low-gain mode (BAND = V_{CC} , GAIN = GND)		-1	+1.5		
Input 1dB Compression Point	IP-1dB	DCS and PCS band, high-gain mode (BAND = GAIN = V_{CC})		-20	-18		dB
		DCS and PCS band, low-gain mode (BAND = V_{CC} , GAIN = GND)		-9	-7		
Input Return Loss	$ S_{11} ^2$	DCS and PCS band, high-gain mode (BAND = GAIN = V_{CC})			-11	-8.5	dB
		DCS and PCS band, low-gain mode (BAND = V_{CC} , GAIN = GND)			-11	-9.5	
Output Return Loss	$ S_{22} ^2$	DCS and PCS band, high-gain mode (BAND = GAIN = V_{CC})			-12	-9.5	dB
		DCS and PCS band, low-gain mode (BAND = V_{CC} , GAIN = GND)			-15	-12	
Reverse Isolation	$ S_{12} ^2$	High-gain mode (BAND = GAIN = V_{CC})	DCS band		-35	-31	dB
			PCS band		-33	-29	
		Low-gain mode (BAND = V_{CC} , GAIN = GND)	DCS band		-21	-18	
			PCS band		-21	-18	

Note 2: Minimum and maximum limits are guaranteed by design and characterization, but not production tested.

Note 3: The part has been fully characterized at the specified frequency range. Operation outside of this range is possible but not guaranteed.

Note 4: Specification excludes circuit board losses.

Note 5: Measured with two tones, $f_{IN1} = 1850\text{MHz}$, $f_{IN2} = 1850.8\text{MHz}$, $P_{IN} = -33\text{dBm}$ for each tone.

Note 6: Measured with two tones, $f_{IN1} = 945\text{MHz}$, $f_{IN2} = 945.8\text{MHz}$, $P_{IN} = -33\text{dBm}$ for each tone.

Note 7: Measured with two tones, $f_{IN1} = 1960\text{MHz}$, $f_{IN2} = 1960.8\text{MHz}$, $P_{IN} = -33\text{dBm}$ for each tone.

GSM900及びDCS1800/PCS1900 デュアルバンド、低ノイズアンプ

MAX2651/MAX2652/MAX2653

標準動作特性

(MAX2651 EV kit, $V_{CC} = +3.0V$, input and output matched with recommended matching networks, $T_A = +25^\circ C$, unless otherwise noted.)

MAX2651 (GSM Band)

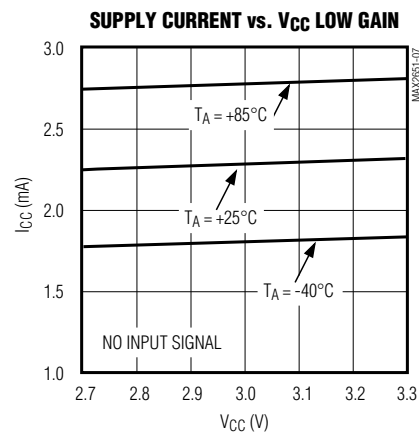
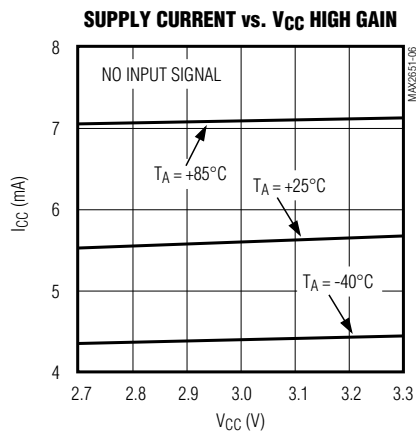
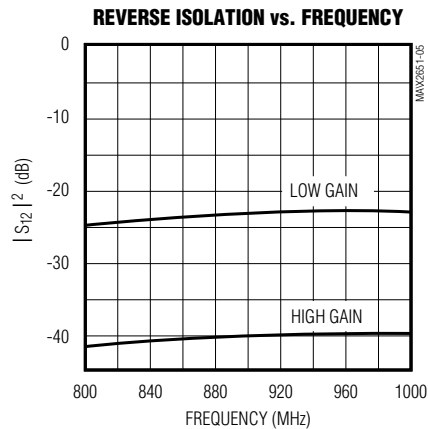
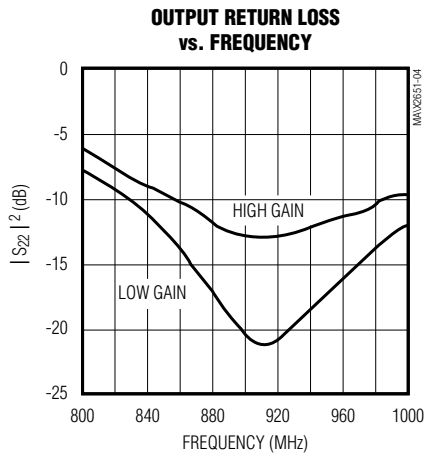
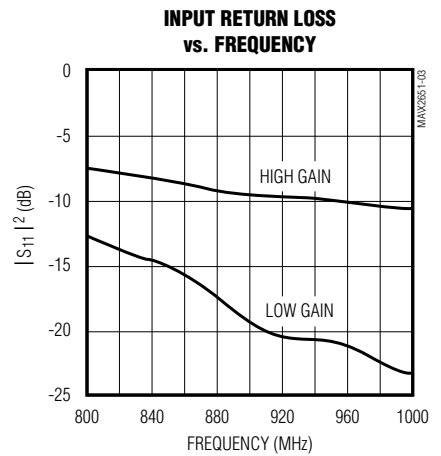
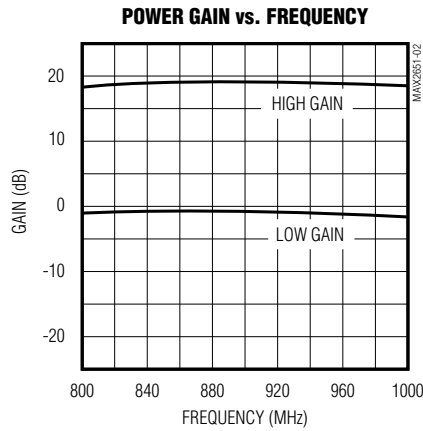
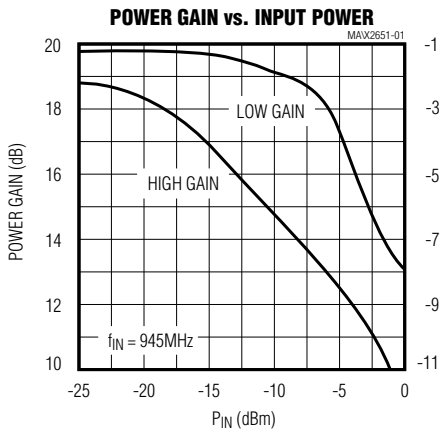

GSM900及びDCS1800/PCS1900 デュアルバンド、低ノイズアンプ

標準動作特性(続き)

(MAX2651 EV kit, $V_{CC} = +3.0V$, input and output matched with recommended matching networks, $T_A = +25^\circ C$, unless otherwise noted.)

MAX2651 (DCS Band)

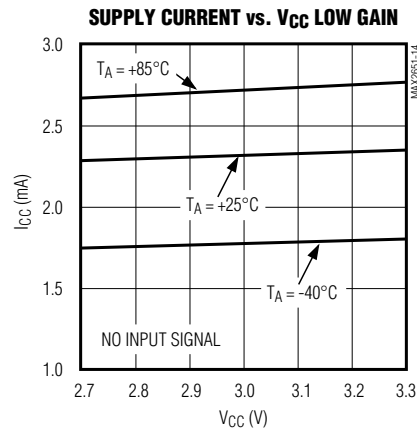
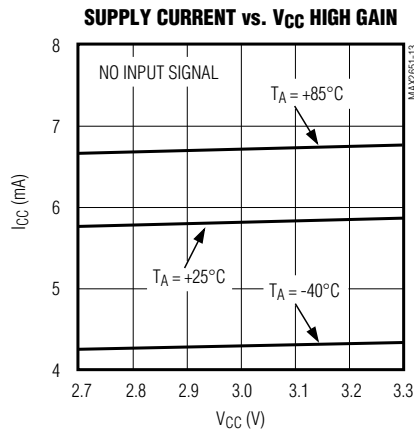
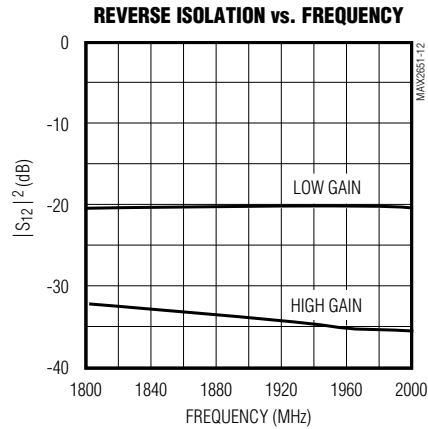
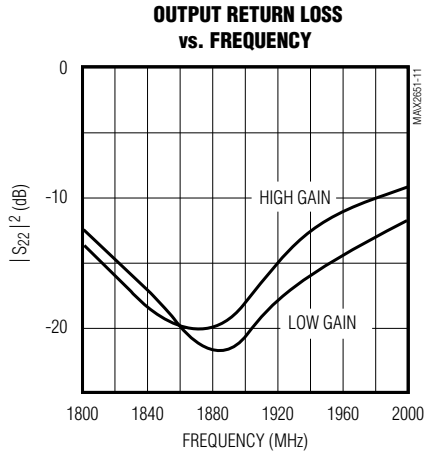
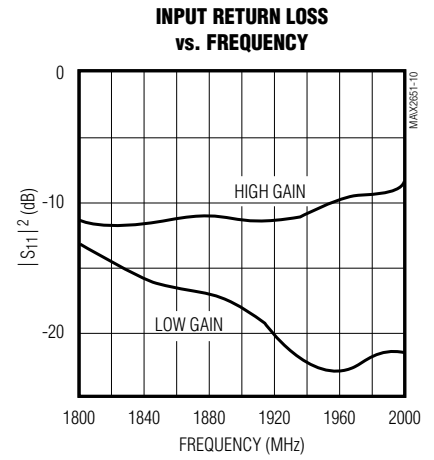
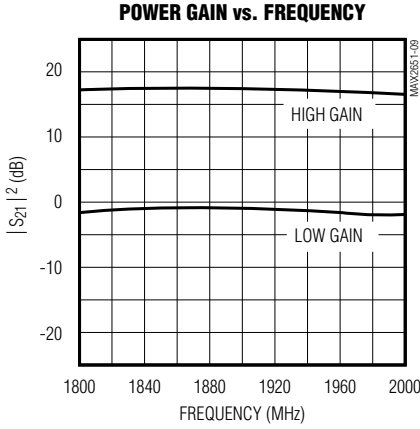
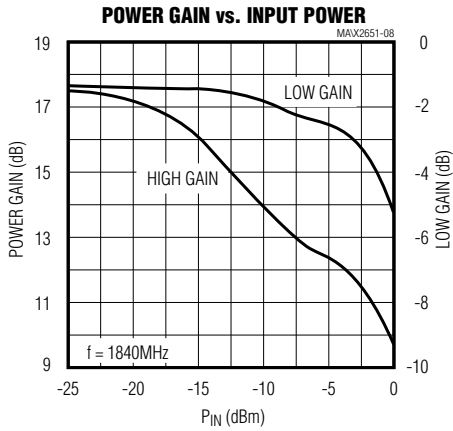

MAX2651/MAX2652/MAX2653

GSM900及びDCS1800/PCS1900 デュアルバンド、低ノイズアンプ

MAX2651/MAX2652/MAX2653

標準動作特性(続き)

(MAX2652 EV kit, $V_{CC} = +3.0V$, input and output matched with recommended matching networks, $T_A = +25^\circ C$, unless otherwise noted.)

MAX2652 (GSM Band)

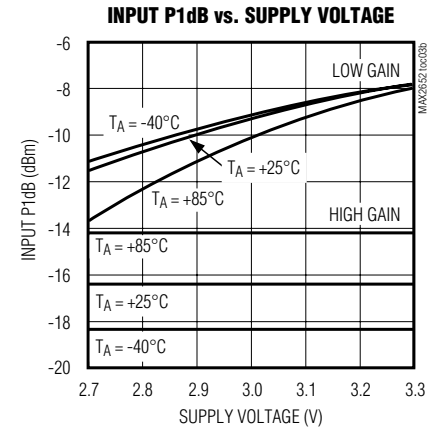
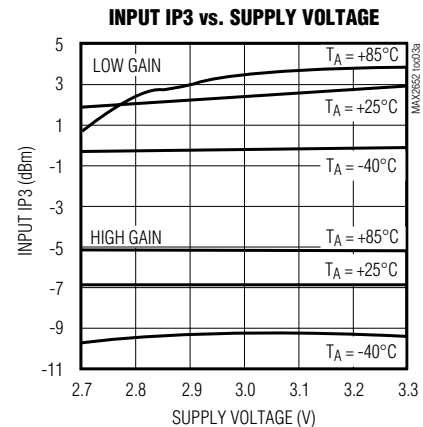
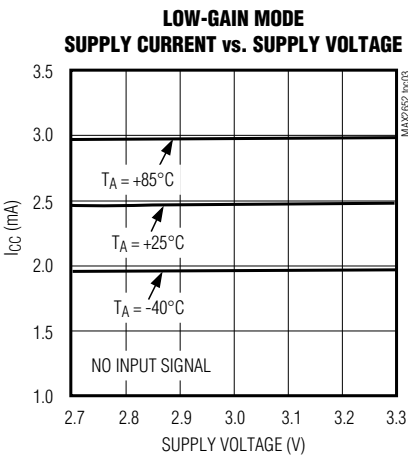
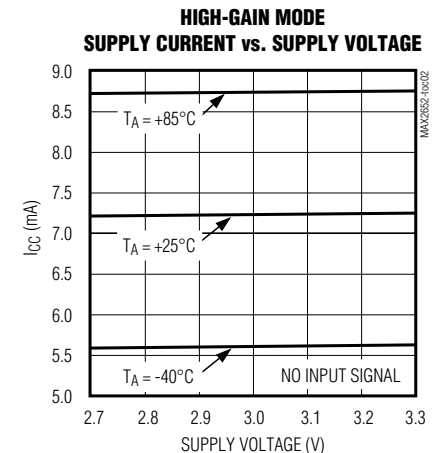
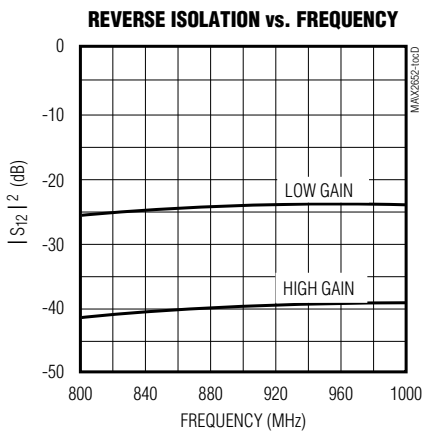
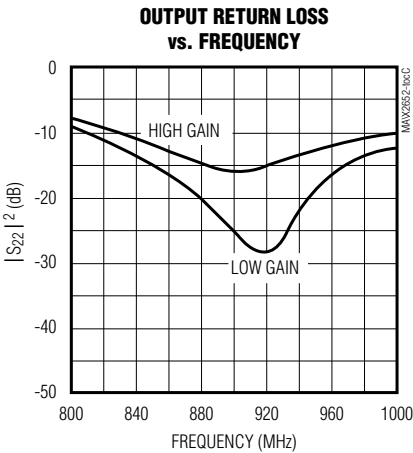
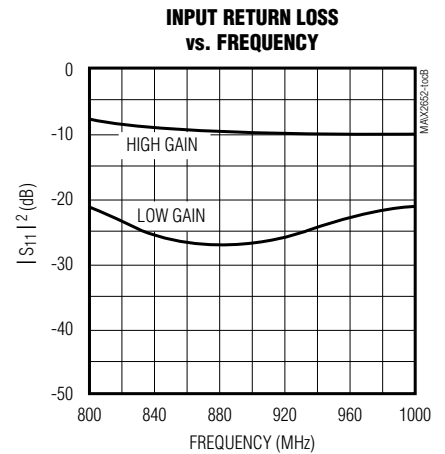
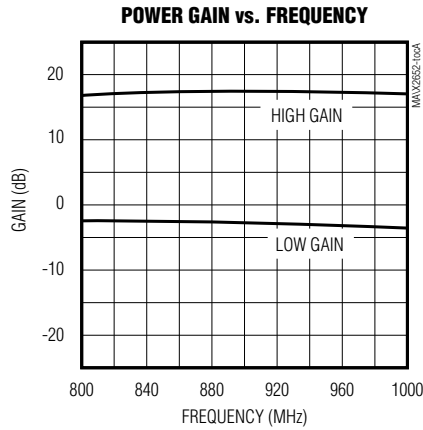
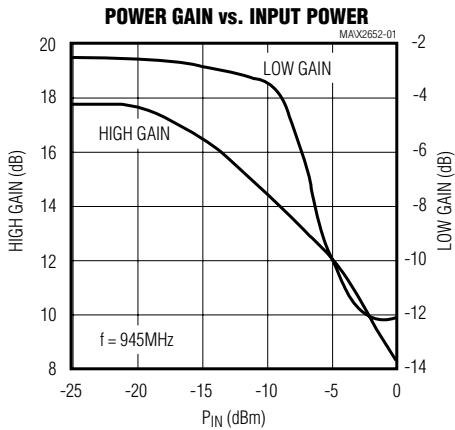

GSM900及びDCS1800/PCS1900 デュアルバンド、低ノイズアンプ

標準動作特性(続き)

(MAX2652 EV kit, $V_{CC} = +3.0V$, input and output matched with recommended matching networks, $T_A = +25^\circ C$, unless otherwise noted.)

MAX2652 (DCS Band)

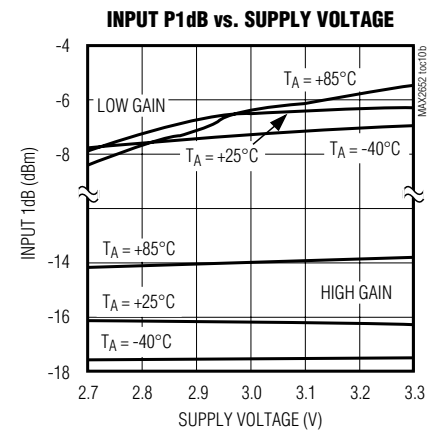
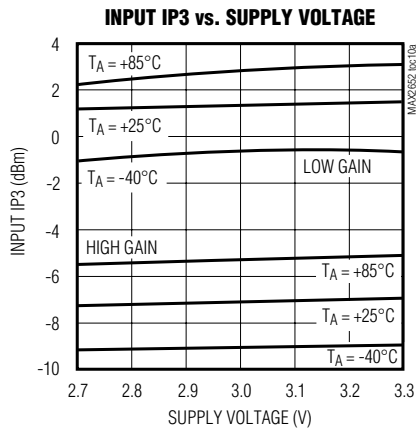
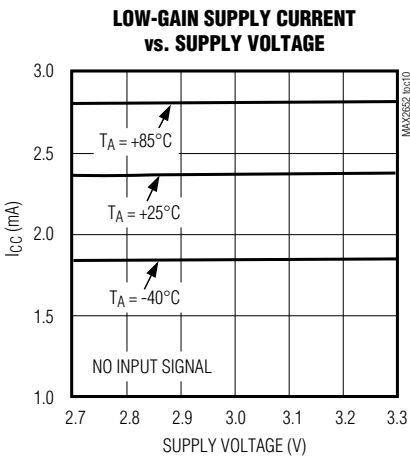
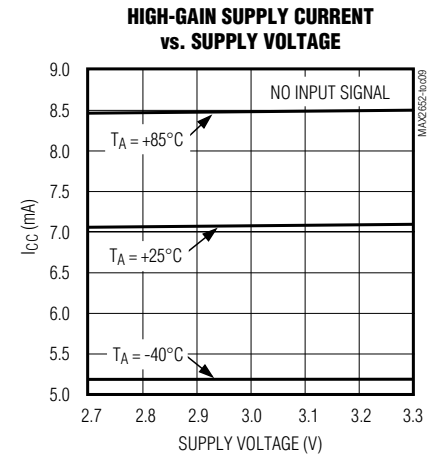
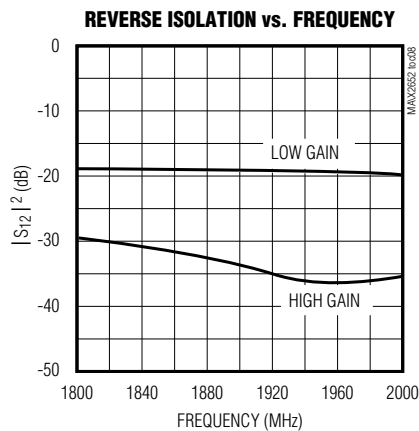
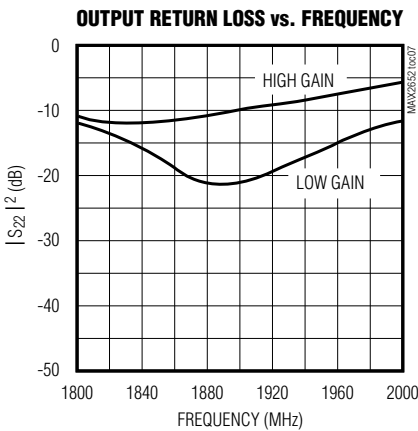
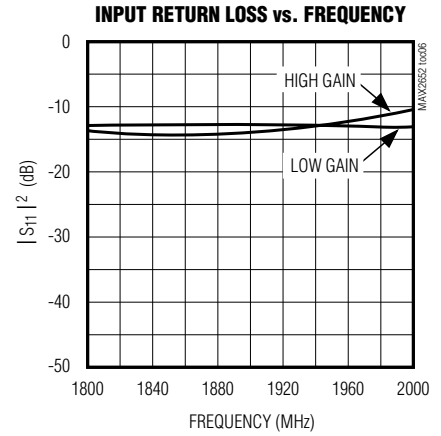
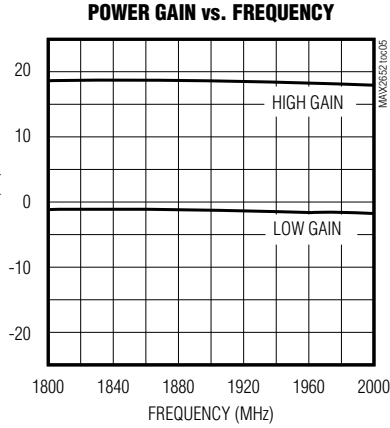
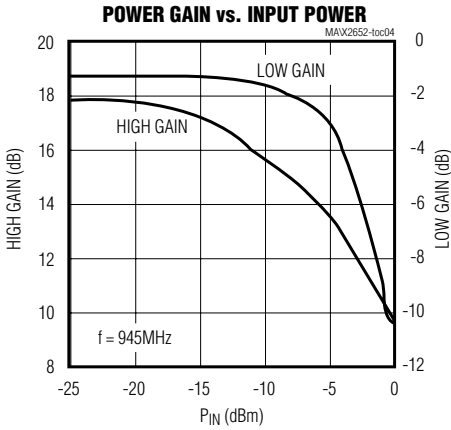

MAX2651/MAX2652/MAX2653

GSM900及びDCS1800/PCS1900 デュアルバンド、低ノイズアンプ

MAX2651/MAX2652/MAX2653

標準動作特性(続き)

(MAX2653 EV kit, $V_{CC} = +3.0V$, input and output matched with recommended matching networks, $T_A = +25^\circ C$, unless otherwise noted.)

MAX2653 (DCS Band)

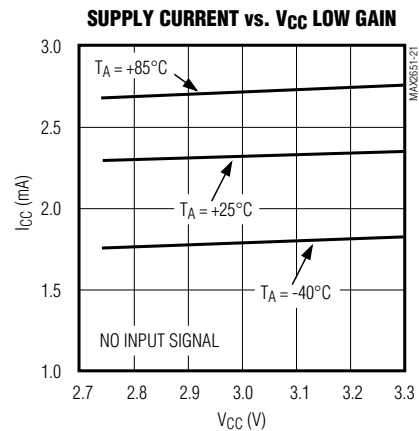
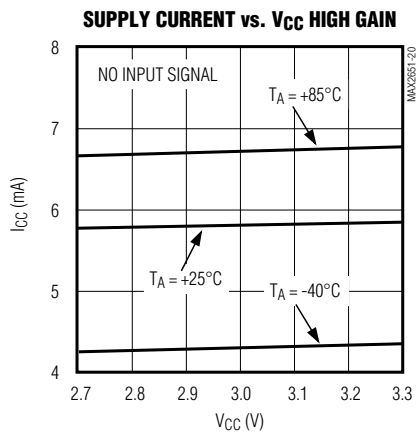
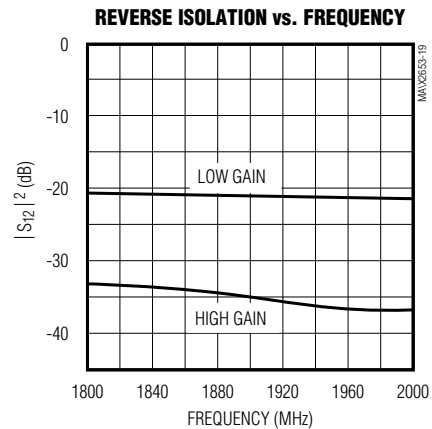
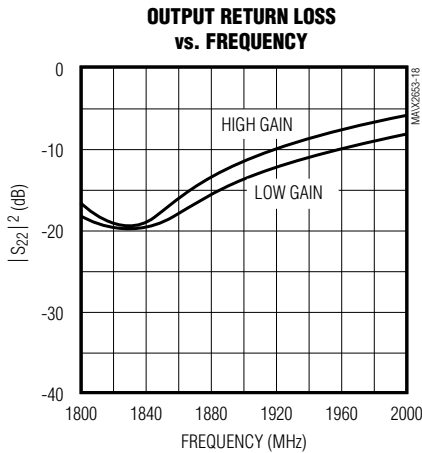
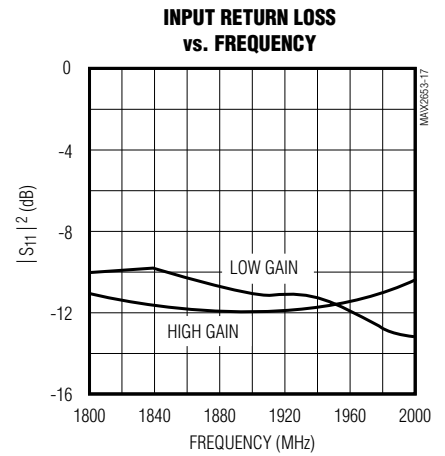
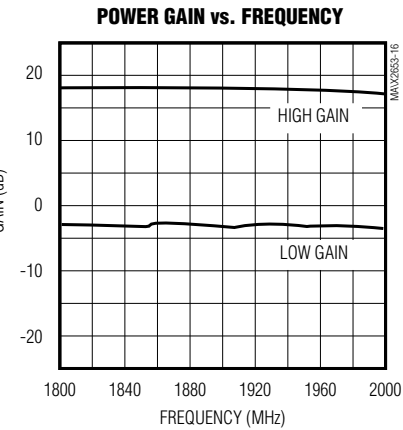
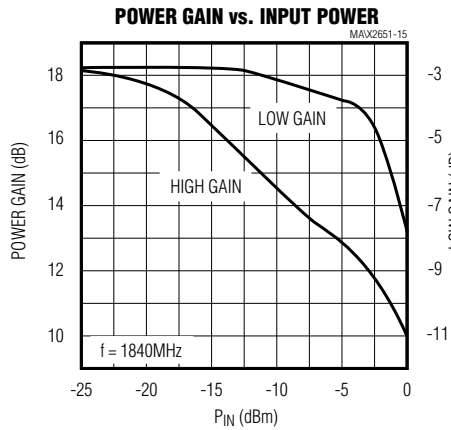

GSM900及びDCS1800/PCS1900 デュアルバンド、低ノイズアンプ

MAX2651/MAX2652/MAX2653

端子説明

端子			名称	機能
MAX2651	MAX2652	MAX2653		
—	1	1	$\overline{\text{SHDN}}$	シャットダウンロジック入力。ローにするとシャットダウンになり、ハイにするか V_{CC} に接続すると通常動作になります。
1, 3, 6	3, 6	2, 4, 5	GND	RFグランド。トレースインダクタンスを最小限に抑えるために、ICのできるだけ近くでグランドプレーンに接続して下さい。
2	2	—	GSMIN	GSMバンドのRF入力
4	4	3	DCSIN	DCS及びPCSバンドのRF入力
5	5	—	BAND	バンド選択ロジック入力。BANDをハイにするとDCS/PCS LNAがイネーブルされ、ローにするとGSM LNAがイネーブルされます。
7	7	6	DCSOUT	DCS及びPCSバンドのRF出力
8	8	7	V_{CC}	電源電圧入力(+2.7V < V_{CC} < +3.3V)
9	9	—	GSMOUT	GSMバンドのRF出力
10	10	8	GAIN	利得選択ロジック入力。GAINをハイにすると高利得動作になり、GAINをローにすると低利得動作になります。



図1. MAX2651の標準アプリケーション回路

GSM900及びDCS1800/PCS1900 デュアルバンド、低ノイズアンプ

MAX2651/MAX2652/MAX2653

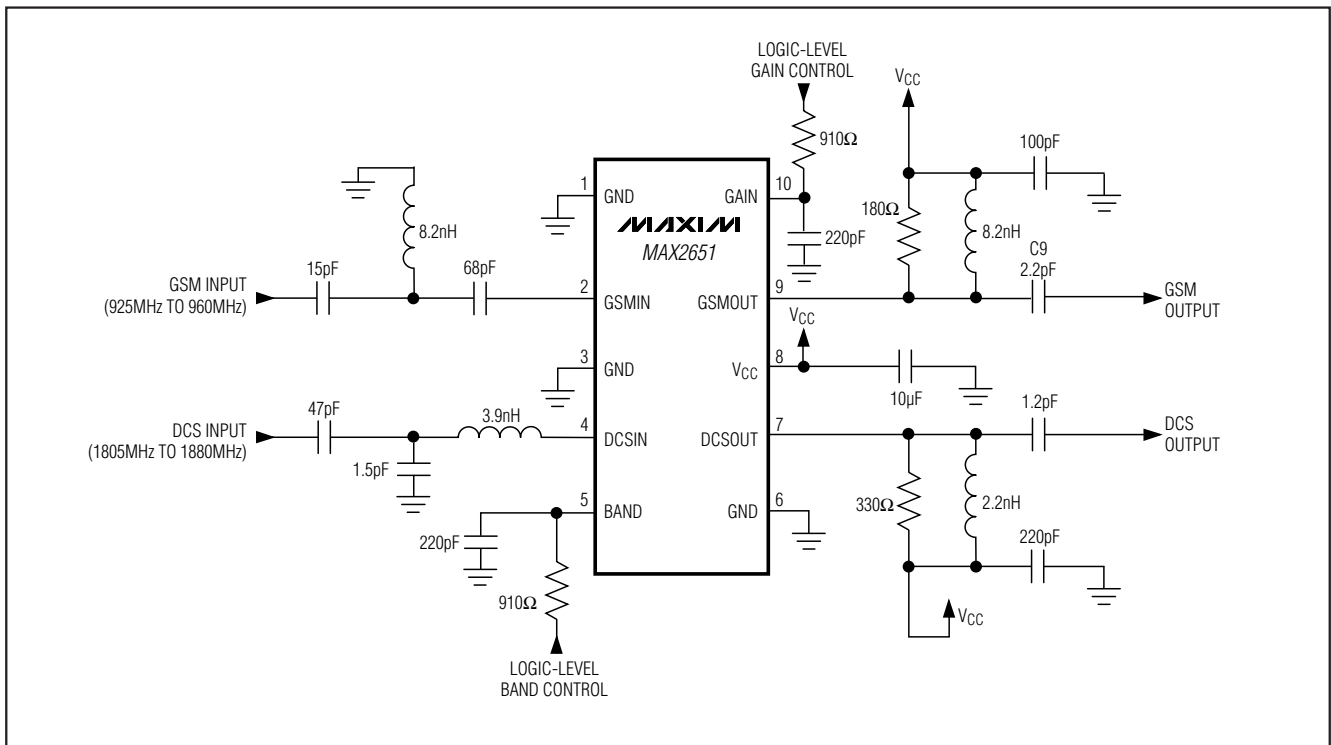

図2. MAX2652の標準アプリケーション回路



図3. MAX2653の標準アプリケーション回路

GSM900及びDCS1800/PCS1900 デュアルバンド、低ノイズアンプ

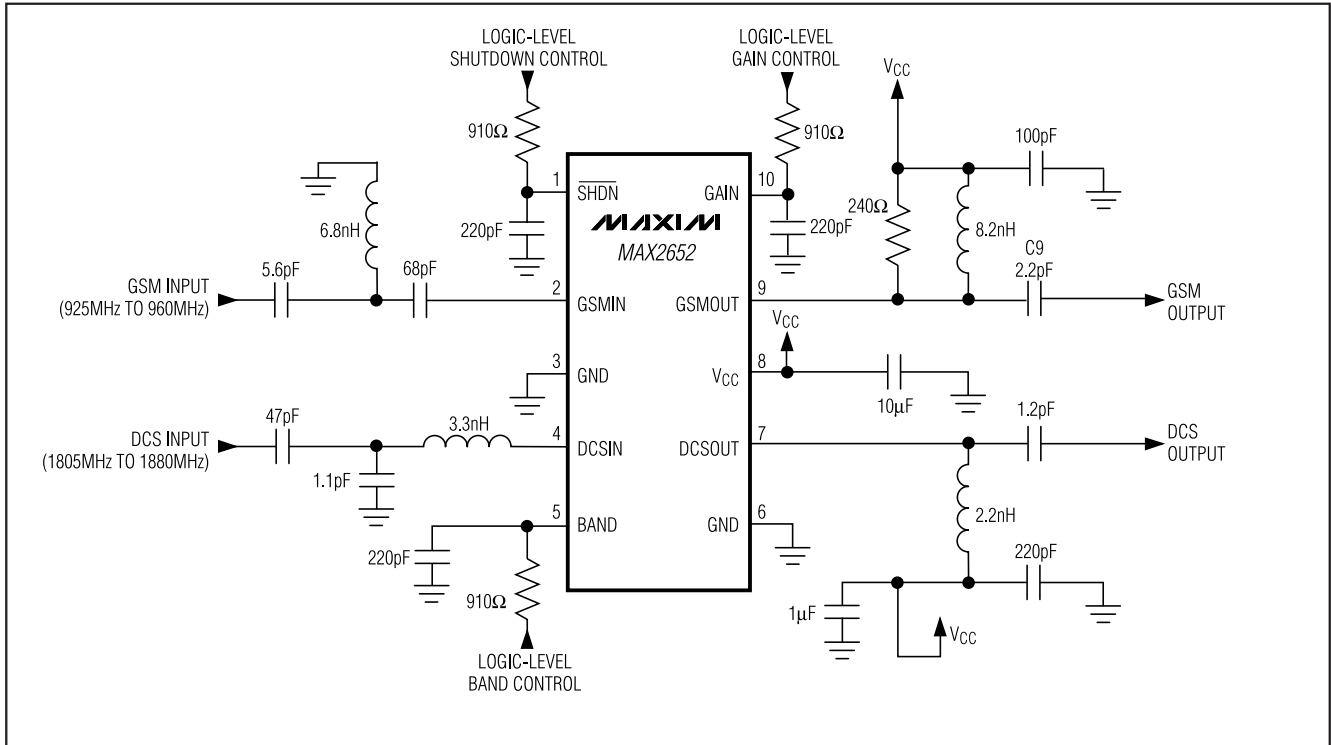
MAX2651/MAX2652/MAX2653

詳細

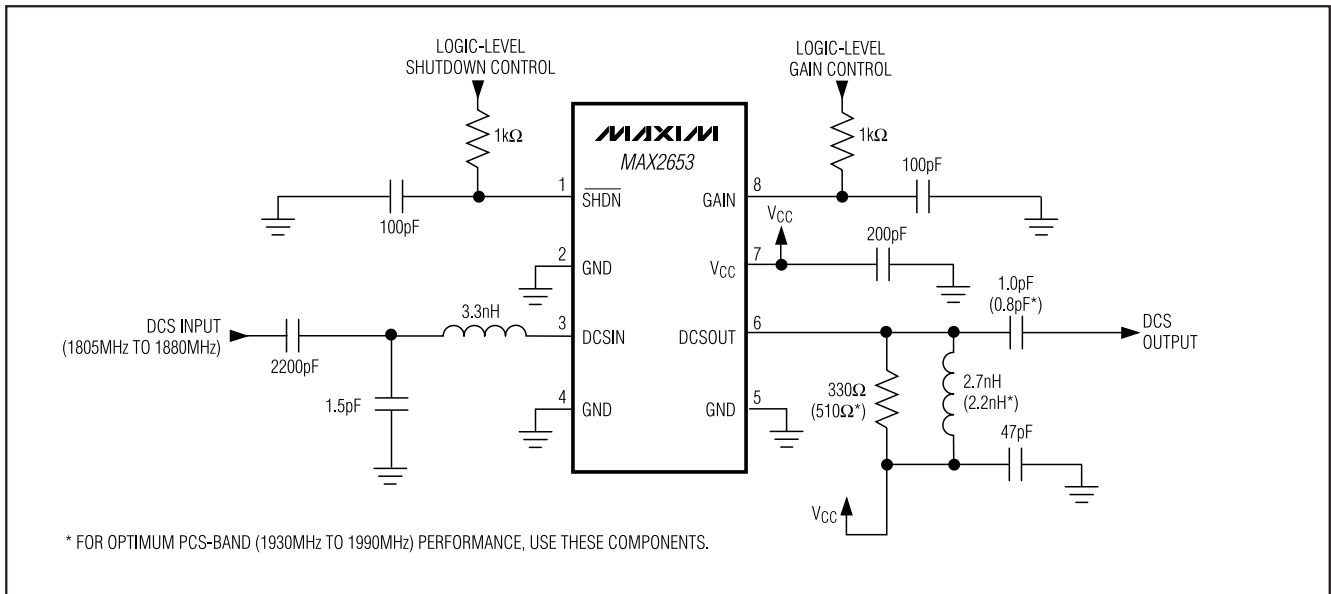
利得選択

MAX2651/MAX2652/MAX2653は、レシーバのダイナミックレンジを最適化するためにLNAのステップ利得を提供しています。GAINがロジックレベルローの場合、アクティブなLNAの利得が約20dB低減され、消費電流が3.5mA減ります。

シャットダウン機能

MAX2652/MAX2653は低電流シャットダウン機能を提供しています。SHDNをローにすると、LNAがパワーダウンして消費電流が0.25 μ Aに減少します。

アプリケーション情報

外付部品

MAX2651/MAX2652/MAX2653を50 Ω システムで動作させるには、入力及び出力の部分でマッチング回路が必要です。図1、2及び3のアプリケーション回路は、各素子のLNAのマッチング回路を示しています。推奨部品定数、メーカ及び部品番号は、MAX2651/MAX2652/MAX2653EVキットデータシートに記載されています。これらの値は、瞬時雑音指数、利得及びリターンロス性能が最高になるように最適化されています。

入力及び出力インピーダンスマッチングネットワークは、レイアウトに依存する寄生パラメータに非常に敏感です。プリント基板の浮遊インダクタンス及び浮遊容量の効果を最小限に抑えるために、全てのマッチング部品を素子のできるだけ近くに配置することが重要です(特に1800MHz及び1900MHzの場合)。

コレクタ負荷抵抗で利得を設定

MAX2651/MAX2652/MAX2653は、外付抵抗で利得を設定できるようにオープンコレクタ出力段を提供しています。コレクタプルアップ抵抗は各LNAの利得を約18dBに設定します。この抵抗を小さくすると利得が小さくなり、この抵抗を大きくすると利得が大きくなります。達成可能な最大の利得は、最大コレクタ電流スイングによって定義されます。LNAの出力インピーダンスは、コレクタ利得設定抵抗の値によって主に決まります。マッチングネットワークは、このインピーダンスを50 Ω にマッチングさせるように同調されています。このため、コレクタ利得設定抵抗を変更してLNA利得を再定義すると、出力マッチングネットワークを再び同調させる必要があります。

レイアウト及び電源バイパス

RF/マイクロ波回路では、プリント基板の適正な設計が重要です。高周波の入力及び出力は、全てインピーダンスが調整されたラインを使用して下さい。GNDピンの適正なグラウンディングが重要です。プリント基板に上面RFグランドが使用される場合は、全てのGNDピンを直接そこに接続して下さい。グランドプレーンが部品面側でない基板の場合は、全てのGNDピンをパッケージの近くのメッキスルーホールでグランドプレーンに接続して下さい。

システム内の各部分間のカップリングを最小限に抑えるために理想的な電源レイアウトは星型構成です。この構成では、大容量のデカップリングコンデンサを中央V_{CC}ノードに配置します。V_{CC}トレースはこのノードから枝分かれし、各々がプリント基板上の個別のV_{CC}ノードに行きます。トレースの各々の末端には、RF周波数で非常に小さなESRを提供する2次バイパスコンデンサが配置されます。これにより、各V_{CC}ピンのところでローカルV_{CC}デカップリングが実現されます。高周波においては、1つの電源ピンから漏れる信号から見て、中央V_{CC}ノードとの間には(V_{CC}トレースインダクタンスによって形成される)比較的大きなインピーダンスがあり、他の電源ピンへはさらに大きなインピーダンスがあります。また、グランドへはバイパスコンデンサを通じて低インピーダンスになっています。

チップ情報

MAX2651 TRANSISTOR COUNT: 272

MAX2652 TRANSISTOR COUNT: 272

MAX2653 TRANSISTOR COUNT: 253

GSM900及びDCS1800/PCS1900 デュアルバンド、低ノイズアンプ

MAX2651/MAX2652/MAX2653

パッケージ

(このデータシートに掲載されているパッケージ仕様は、最新版が反映されているとは限りません。最新のパッケージ情報は、japan.maxim-ic.com/packagesをご参照下さい。)

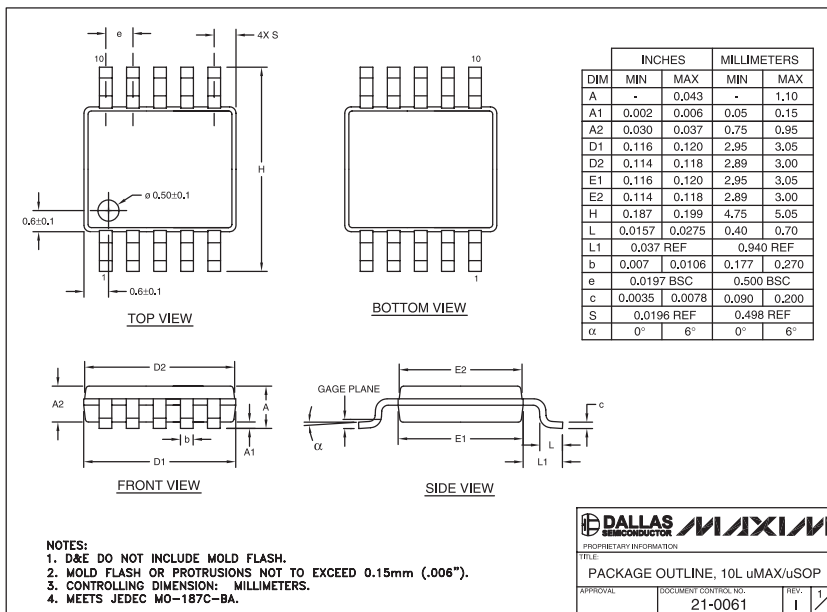
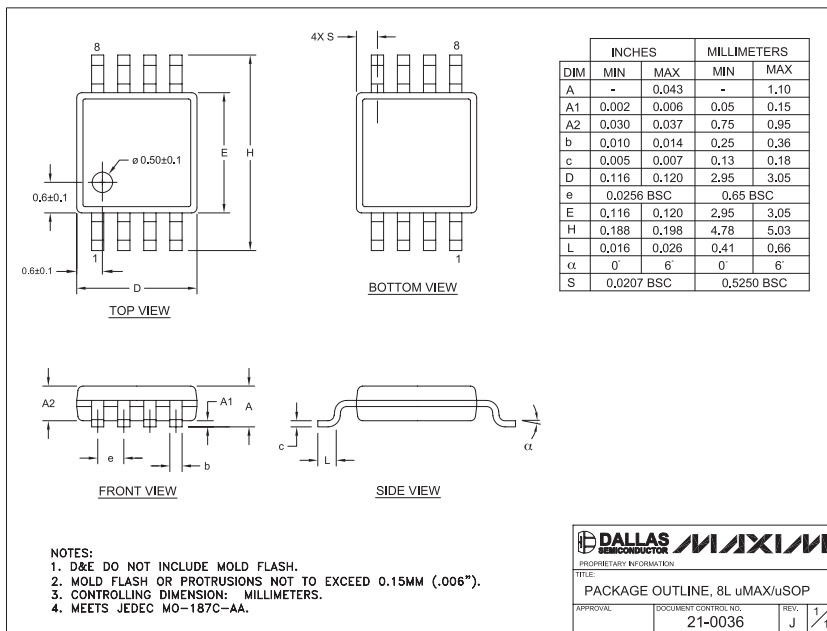

注：これらのデバイスのパッケージにはエクスポーズドパッドはありません。

マキシム・ジャパン株式会社

〒169-0051 東京都新宿区西早稲田3-30-16 (ホリゾン1ビル)
 TEL. (03)3232-6141 FAX. (03)3232-6149

マキシムは完全にマキシム製品に組込まれた回路以外の回路の使用について一切責任を負いかねます。回路特許ライセンスは明言されていません。マキシムは随時予告なく回路及び仕様を変更する権利を留保します。

16 **Maxim Integrated Products, 120 San Gabriel Drive, Sunnyvale, CA 94086 408-737-7600**

© 2003 Maxim Integrated Products, Inc. All rights reserved. **MAXIM** is a registered trademark of Maxim Integrated Products.