

Evaluating the LTC9101-2/LTC9101-2A/LTC9101-2B and LTC9102 48-Channel IEEE 802.3at/bt PSE**GENERAL DESCRIPTION**

The EVAL-LTC9101-2 is a 48-channel IEEE 802.3at/bt compliant power sourcing equipment (PSE). The EVAL-LTC9101-2 includes the DC3159A-C, DC3159A-D, or DC3159A-E daughter card, the DC3017A-B motherboard, and features the [LTC9101-2/LTC9101-2A/LTC9101-2B](#) and [LTC9102](#) chipset.

In the EVAL-LTC9101-2, the daughter card has a single LTC9101-2x digital controller, where X denotes either the LTC9101-2, LTC9101-2A, or the LTC9101-2B. The DC3159A-C has the [LTC9101-2](#), the DC3159A-D daughter card has the [LTC9101-2A](#) and the DC3159A-E has the [LTC9101-2B](#). The digital controller interfaces with four [LTC9102](#) (12-channel) analog controllers for a total of 48 PSE channels.

The LTC9101-2x use a proprietary isolated data interface allowing the LTC9101-2x digital controller to directly connect to the host controller I²C interface and eliminating the need for costly optocouplers and an additional 3.3 V supply.

The EVAL-LTC9101-2 kit connects to up to twenty-four, 802.3af/at/bt PDs directly at each port for 4-pair power evaluation.

This kit version can operate autonomously or with host control over I²C.

The EVAL-LTC9101-2A kit connects to up to forty-eight, 802.3af/at PDs with an ethernet splitter for each two ports for 2-pair power evaluation. This kit version requires host control over I²C.

The EVAL-LTC9101-2B kit connects to up to forty-eight, 802.3af/at/bt PDs with an ethernet splitter for each two ports for 2-pair power evaluation. This kit version can operate autonomously or with host control over I²C.

Indicator LEDs quickly show channel status for the 48 power channels. An optional on-board buck regulator provides 3.3 V from the V_{EE} supply for the digital circuitry. This demonstration manual provides an EVAL-LTC9101-2 overview and quick start procedure.

Design files for this circuit board are available at

<https://www.analog.com/EVAL-LTC9101-2>

All registered trademarks and trademarks are the property of their respective owners.

TABLE OF CONTENTS

General Description.....	1	Isolation.....	8
EVAL-LTC9101-2 Evaluation Board Photo.....	3	PWRMD Settings.....	8
Quick Start Procedure.....	4	Device Configuration.....	8
EVAL-LTC9101-2 Overview.....	7	Digital Connections.....	8
Port Output.....	7	OSS and RESET Push Buttons.....	8
Daughter Card Insertion Precautions.....	7	On Board 3.3 V Supply.....	9
LED Indicators.....	7	Surge Testing.....	9
I ² C Address.....	7	Evaluating the EVAL-LTC9101-2A/EVAL-	
Main V _{EE} PoE Supply.....	8	LTC9101-2B.....	9

REVISION HISTORY**11/2024—Rev. 0 to Rev. A**

Changes to User Guide Title	1
Changes to General Description Section.....	1
Changes to Table 1.....	3
Changes to Quick Start Procedure Section.....	4
Changes to Table 2.....	4
Changes to Figure 4.....	6
Changes to Port Output Section.....	7
Changes to I ² C Address Section.....	7
Changes to Figure 5 Caption.....	7
Change to PWRMD Settings Section.....	8
Changed Evaluating the EVAL-LTC9101-2A Section to Evaluating the EVAL-LTC9101-2A/EVAL-	
LTC9101-2B Section.....	9
Changes to Evaluating the EVAL-LTC9101-2A/EVAL-LTC9101-2B Section.....	9
Changes to Figure 9.....	9

8/2023—Revision 0: Initial Version

EVAL-LTC9101-2 EVALUATION BOARD PHOTO

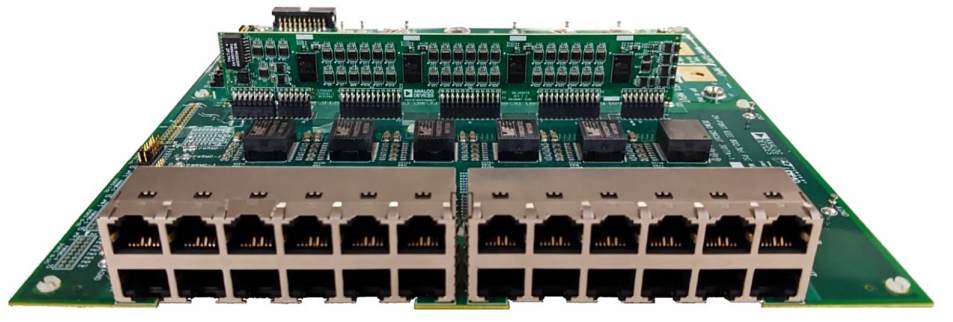

Figure 1. EVAL-LTC9101-2 Evaluation Board Photo

Table 1. EVAL-LTC9101-2 Kit Options

Demo Kit	IEEE Standard	Daughter Card	Mother Board	LTC9101 Version	2-Pair Ports	4-Pair Ports	PSE Management
EVAL-LTC9101-2	802.3bt	DC3159A-C	DC3017A-B	-2	0	24	Host or auto
EVAL-LTC9101-2A	802.3at	DC3159A-D	DC3017A-B	-2A	48	0	Host only
EVAL-LTC9101-2B	802.3bt	DC3159A-E	DC3017A-B	-2B	48	0	Host or auto

QUICK START PROCEDURE

Follow the procedure below and see [Figure 2](#) through [Figure 4](#), and [Table 2](#) through [Table 4](#) for proper equipment setup and default configuration.

NOTE: Step 1 does not apply to the EVAL-LTC9101-2A.

- For autonomous operation with the EVAL-LTC9101-2/EVAL-LTC9101-2B, set the jumper PWRMD-1 (JP1) on the DC3017A-B motherboard to PM1 or PM2 for the EVAL-LTC9101-2B and PM3 through PM7 for the EVAL-LTC9101-2. See [Table 2](#) for all PWRMD-1 options and the [PWRMD Settings](#) section for more information.
- On the DC3017A-B motherboard, set the address switches AD2 and AD3 (SW5) to LO and JP22 (AD1) to LO for the default 0x20 base I²C address.
- On the DC3017A-B motherboard, set the CFG1 (JP20) and CFG1 (JP21) jumpers to HI to set CFG[1:0] logically to 11b to enable all ports. See [Table 3](#) for more configuration options.
- Align pin 1 of the 16-pin male connector P1 on the DC3159A daughter card with pin 1 of the 16-pin female connector J11 on the DC3017A-B motherboard as shown in [Figure 3](#). The six male connectors and six female sockets should match. Keyed pins in J16 and J12 assist with the alignment shown in [Figure 4](#). Carefully push the daughter card straight down until the male and female connectors are flush with each other.
- Connect a supply to the DC3017A-B motherboard with the positive rail to POS INPUT (+) and negative rail to NEG INPUT (-) as shown in [Figure 4](#). Use a power supply capable of sourcing the maximum power for all ports to be tested. Ramp the supply up to within the recommended voltage range specified in [Table 4](#).

NOTE: Banana jacks J8 and J10 should only be used for up to 15 A of supply current. Use the lug nut terminals J7 and J9 for supply currents of up to 50 A; enough for 24 ports at maximum IEEE 802.3bt power.

- Connect the DC590B or other I²C host controller at 14-pin connector (J1) as shown in [Figure 4](#). Host control is required for EVAL-LTC9101-2A.
- Connect IEEE 802.3af, 802.3at, or 802.3bt PDs to the motherboard's RJ45 connectors J3 and J4, as shown in [Figure 4](#).

Table 2. EVAL-LTC9101-2/EVAL-LTC9101-2B PWRMD-1 (JP1) Jumper Settings

PWRMD-1 Jumper Setting	R _{PWRMD} Resistor	Mode	
		EVAL-LTC9101-2	EVAL-LTC9101-2B
PM0	OPEN	HOST ONLY	HOST ONLY
PM1	24.3k	RESERVED	Class 3: 13W
PM2	18.7k	RESERVED	Class 4: 25.5W
PM3	14.3k	Class 4: 25.5W	RESERVED
PM4	11.0k	Class 5: 40W	RESERVED
PM5	8.45k	Class 6: 51W	RESERVED
PM6	6.49k	Class 7: 62W	RESERVED
PM7	1.00k	Class 8: 71.3W	RESERVED

Table 3. EVAL-LTC9101-2 Kit CFG1 and CFG0 Jumper Settings

Jumper		# of Analog Controllers	Number of Channels
CFG1 (JP21)	CFG0 (JP20)		
LO	LO	1	12
LO	HI	2	24
HI	LO	3	36
HI	HI	4	48

Table 4. EVAL-LTC9101-2 Kit Power Supply Voltage per PSE Type

IEEE 802.3 Type, Max Class	Supply Voltage Range
Type 2, up to Class 4	51 V to 57 V
Type 3, up to Class 6	
Type 4, up to Class 8	53 V to 57 V

QUICK START PROCEDURE

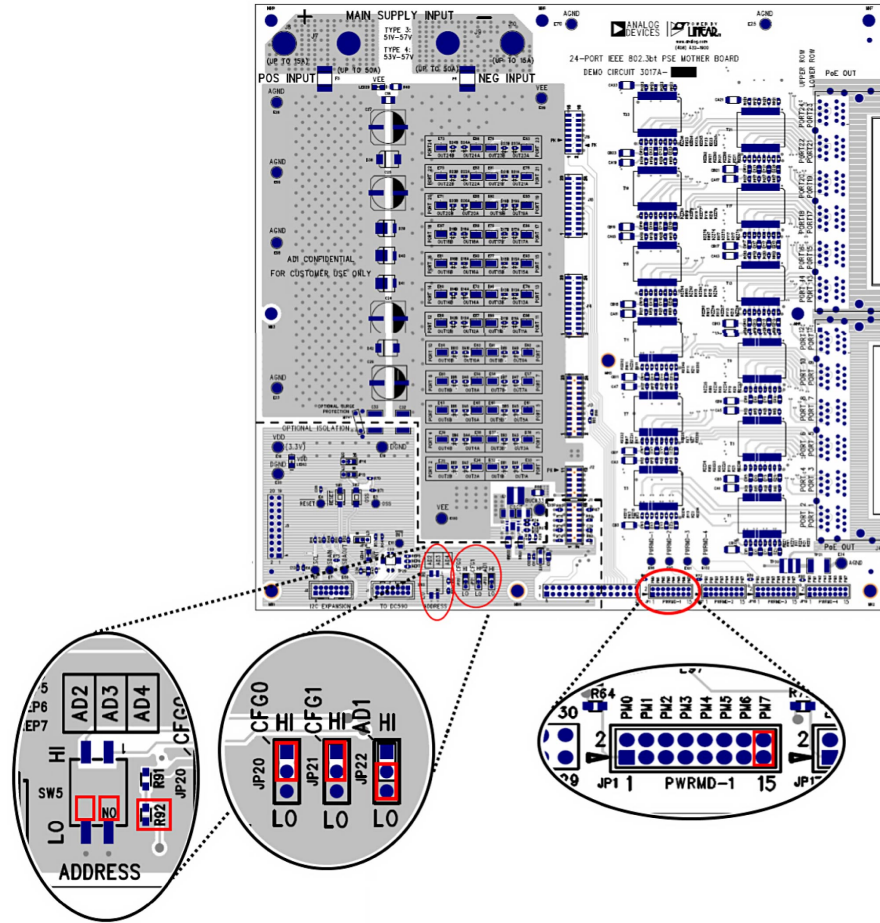

Figure 2. Default Settings for DC3017A-B Motherboard, Jumpers PWRMD0, AD1, CFG0, and CFG1; Switches: AD2 and AD3; Resistor options for AD4

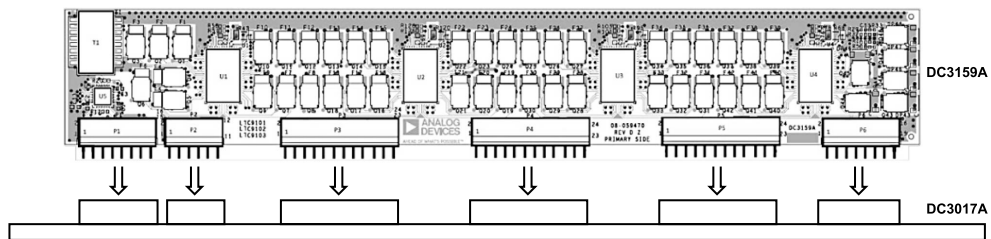

Figure 3. Inserting the DC3159A Daughter Card into J1 through J6 of the DC3017A-B Motherboard

QUICK START PROCEDURE

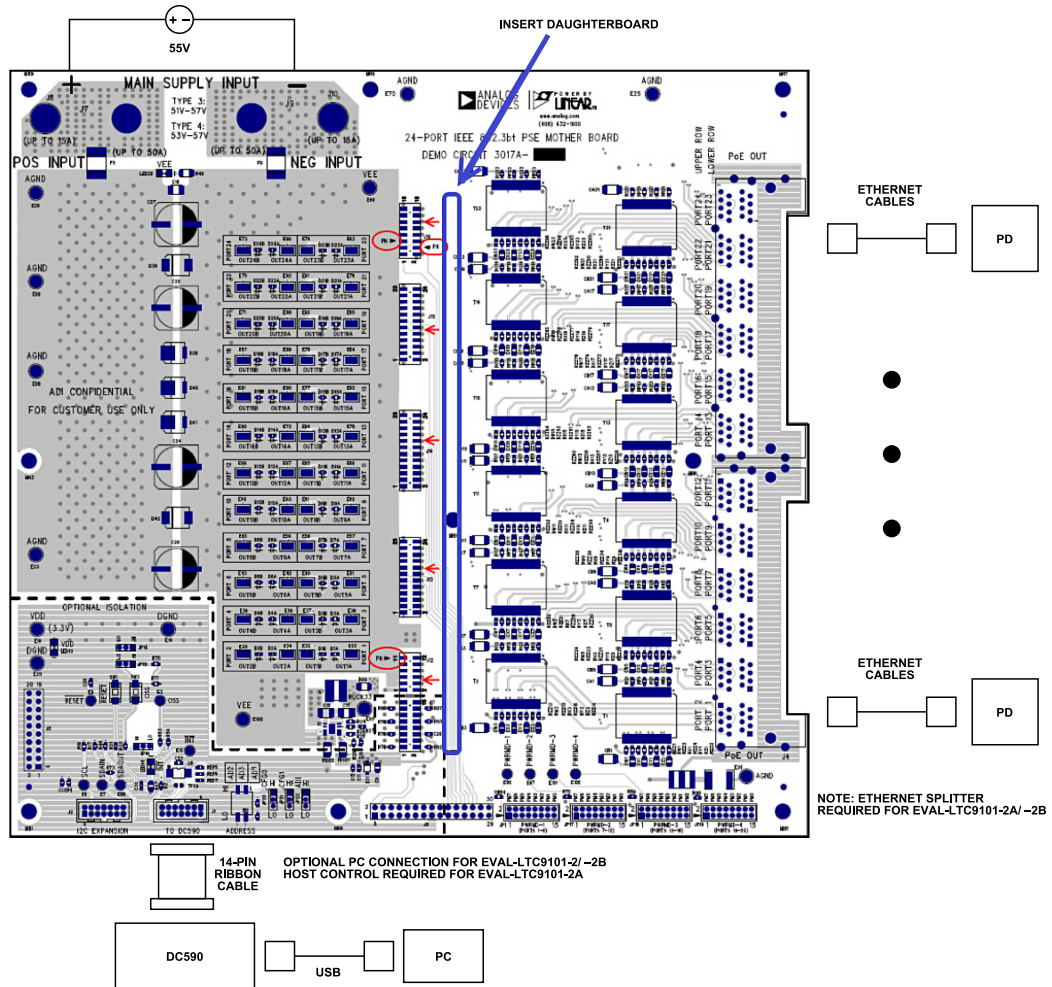

Figure 4. EVAL-LTC9101-2 Kit Connections

EVAL-LTC9101-2 OVERVIEW

The EVAL-LTC9101-2 includes the DC3017A-B, a 24-Port, 4-pair IEEE 802.3at/bt PoE PSE motherboard for a PSE endpoint. This motherboard accepts either the DC3159A-C or DC3159A-D daughter card with up to forty-eight power channels. It contains two, 2x6, RJ45 connectors and twenty-four 1000BASE-T Ethernet transformers rated for IEEE 802.3bt Type 4, Class 8 power levels. The DC3017A-B motherboard also has switches, jumpers, and push buttons for configuring the PSE, with status LEDs and test points.

PORT OUTPUT

The PDs are connected using an ethernet cable (Cat5, Cat5e or better cabling as specified by IEEE 802.3) to any of the ports at the two, 2x6, RJ45 connectors J3 and J4 on the DC3017A-B motherboard. The [LTC9101-2A](#) and [LTC9101-2B](#) deliver power over one power channel as a 2-pair PSE. The [LTC9101-2](#) delivers power over two power channels as a 4-pair PSE. The term “channel” refers to the PSE circuitry assigned to a corresponding pairset. Each port on the DC3017A-B is connected as a 4-pair port driven by two power channels; OUTnA and OUTnB connect to port n (n = port #). OUTnA pairset connects to Alternative A (pairs 1, 2 and 3, 6) and OUTnB pairset connects to Alternative B (pairs 4, 5 and 7, 8). Test points for each channel output, OUT1A through OUT24B are provided.

A 2-pair PSE uses a single power channel per port, connected to either Alternative A or Alternative B. EVAL-LTC9101-2A and EVAL-LTC9101-2B require an ethernet splitter to separate each 4-pair port into two 2-pair ports. See [Evaluating the EVAL-LTC9101-2A/EVAL-LTC9101-2B](#) for more information. See [Figure 5](#) for the port output map of the EVAL-LTC9101-2A and EVAL-LTC9101-2B. Note, while the LTC9101-2B is IEEE 802.3bt compliant it operates as a 2-pair PSE only, and as such it only supports up to Class 4 (25.5W).

The EVAL-LTC9101-2 supports 24, 4-pair ports. See [Figure 6](#) for the port output map of the EVAL-LTC9101-2.

DAUGHTER CARD INSERTION PRECAUTIONS

When inserting or removing the daughter card into the DC3017A-B motherboard, verify all supplies and LEDs are off. Push the card straight down for insertion or pull straight up for removal to avoid bending the connector pins. Follow the instructions in the [Quick Start Procedure](#) for alignment and see [Figure 3](#).

LED INDICATORS

The V_{EE} LED (D29) and V_{DD} LED (LED13) indicate if a voltage is present at the respective supplies. Verify these LEDs are off before inserting or removing the daughter card.

Each port pairset power channel has a respective OUTnM (n = port #, M = port powered pairset; with A = Alternative A and B = Alternative B) LED to indicate if the channel is detecting, classifying, or powered. A blue LED is connected to each OUTnA, while a green LED is connected to each OUTnB. The red INT LED (LED14) indicates if the interrupt line is pulled low by the daughter card.

I²C ADDRESS

The LTC9101-2x primary 7-bit serial bus address is 01A₄A₃A₂A₁0b, with bits A[4:1] set by the pins AD[4:1] respectively. AD1 is set by the AD1 jumper (JP2), AD2 and AD3 are set by the Address switch (SW5), and AD4 is set by resistor stuff options, R91 (HI) and R92 (LO).

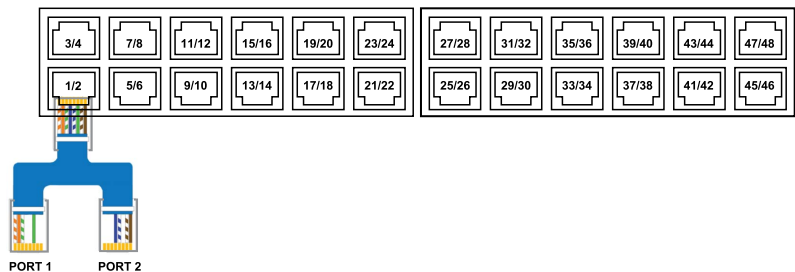

Figure 5. EVAL-LTC9101-2A/EVAL-LTC9101-2B Port Output Map

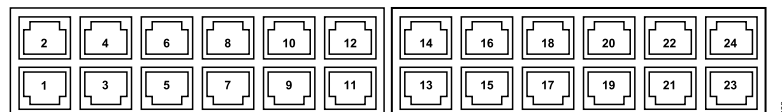

Figure 6. EVAL-LTC9101-2 Port Output Map

EVAL-LTC9101-2 OVERVIEW

MAIN V_{EE} POE SUPPLY

The V_{EE} supply is the main PoE supply connected to the DC3017A motherboard. See the [Quick Start Procedure](#) for proper connection and [Table 4](#) for appropriate supply voltage ranges.

Choose a power supply with a current limit set higher than the maximum allowed output power at each port. Use the appropriate input supply connections per the maximum current expected during testing; banana jacks for up to 15 A or Panduit S4-14R lug nuts for up to 50 A, as seen in [Figure 7](#). The lugs are designed for crimping to 4 AWG welding cable. Use a Thomas & Betts WT115 crimping tool to crimp the S4-14R lugs to 4 AWG welding cable; do not mash or solder the lugs. To avoid damage to the motherboard, do not over tighten the lugs. A torque sufficient to fully compress the split washer (roughly equivalent to 400 in-oz applied to the $\frac{1}{4}$ -28 hex nut) is sufficient to produce good electrical contact.

J8 AND J10 BANANA JACKS FOR UP TO 15A J7 AND J9 LUG NUTS FOR UP TO 50A

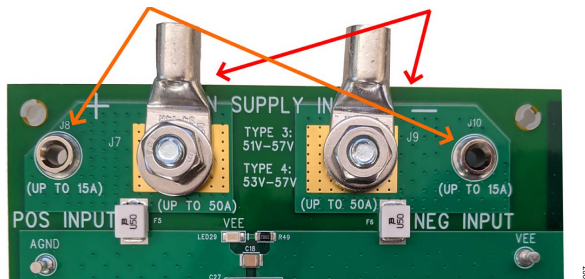

Figure 7. Motherboard Power Supply Connections

ISOLATION

The IEEE 802.3 Ethernet specifications require network segments (including the analog PoE circuitry) to be electrically isolated from the chassis ground. The DC3017A motherboard and DC3159A daughter card layouts and high voltage capacitors provide an isolation barrier between Analog and Digital domains. Transformers provide a galvanic barrier between DGND and AGND on the DC3159A daughter card. By default, this isolation barrier is bridged by resistors on the motherboard to allow for evaluation using a single power supply. Remove RISO1 and RISO2, then provide an external 3.3 V supply between V_{DD} and DGND to evaluate this board as an isolated system.

All RJ45 shields and terminations are connected to chassis ground. AGND and V_{EE} each connect to chassis ground with two pairs of 1 nF, 2 kV capacitors (C6-C9). AGND and V_{EE} also connect to DGND each with 10 nF, 2 kV capacitors (C32-C33). An optional 0 Ω resistor can be installed at RISO3 to tie the chassis ground to DGND. Two series 1206, 5.1 M Ω resistors connect between AGND and DGND for high voltage capacitance discharge. See [Figure 8](#) for connections between Analog and Digital domains, as well as chassis ground on the DC3017A motherboard.

The DC3159A daughter card is laid out with isolation.

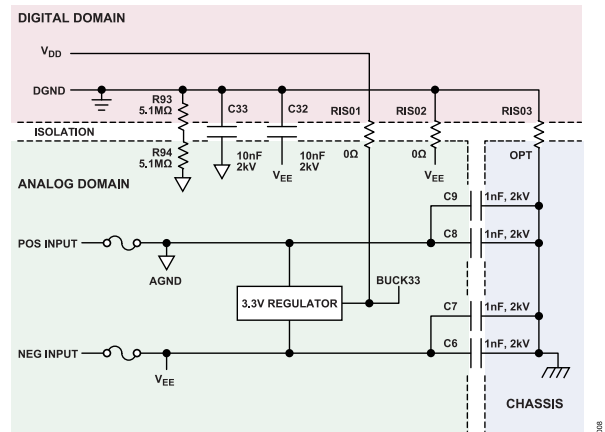

Figure 8. Motherboard Power Supply Connections and Isolation Barriers

PWRMD SETTINGS

The [LTC9101-2/LTC9101-2B/LTC9102](#) operating mode and maximum class while in auto mode depends on the PWRMD0 pin state of the [LTC9102](#) at bus address ID:00b during reset. Reset occurs on a V_{DD} or V_{EE} power cycle, $\overline{\text{RESET}}$ pin is pulled low and released high, or when the global Reset All bit is set. Changing the state of this pin will not change the PSE configuration until a reset occurs. The PWRMD0 pin connects to the R_{PWRMD} resistor using the PWRMD-1 jumper. R_{PWRMD} is used to automatically determine the power allocation per port. See [Table 2](#) for the PWRMD0 and R_{PWRMD} settings. The [LTC9101-2A](#) does not check the PWRMD0 pin state.

DEVICE CONFIGURATION

The CFG0 and CFG1 pins configure the number of analog controllers in the system. Each pin connects to a jumper that pulls either HI for a logical 1, or LO for logical 0. CFG1 and CFG0 set the number of analog controllers in the system. See [Table 3](#) for the CFG[1:0] settings.

DIGITAL CONNECTIONS

The DC590 USB to I²C controller board is connected to the DC3017A-B motherboard at J1 through a 14-pin ribbon cable. The LTC9101-2x I²C address is set by the pins AD4, AD3, AD2, and AD1. See [I²C Address](#) section for more information. SDAOUT and SDAIN can be tied together through a shunt resistor, R73. Turrets on the DC3017A-B motherboard provide test points for SCL, SDAIN, SDAOUT, V_{DD} , DGND, $\overline{\text{INT}}$, OSS, and $\overline{\text{RESET}}$.

OSS AND $\overline{\text{RESET}}$ PUSH BUTTONS

Push button switch SW1, when pressed, pulls the $\overline{\text{RESET}}$ pin of the daughter card logic low. The PSE controller is then held inactive with all ports off. When SW1 is released, $\overline{\text{RESET}}$ is pulled high, and the PSE returns to the reset state.

Push button switch SW2, when pressed pulls the overload supply shutdown input, OSS pin of the daughter card logic low. When

EVAL-LTC9101-2 OVERVIEW

pressed, all ports that have their corresponding mask bit set in the mconfig register of the PSE controller will be shutdown. These ports must then be manually re-enabled via I²C or by resetting the PSE.

ON BOARD 3.3 V SUPPLY

The DC3017A-B motherboard has an on board (non-isolated) 3.3 V/100 mA buck regulator that provides a local 3.3 V, with the net named BUCK33. This on board logic supply is for demonstration purposes only and allows for use of a single supply while evaluating the EVAL-LTC9101-2 kit.

SURGE TESTING

The EVAL-LTC9101-2 kit can be configured with either the Digital domain connected to reference ground plane, or with the Digital domain floating with the Analog domain for different surge test setups. The default EVAL-LTC9101-2 kit configuration has DGND connected to V_{EE} and floating from chassis ground.

EVALUATING THE EVAL-LTC9101-2A/EVAL-LTC9101-2B

The LTC9101-2A/LTC9101-2B/LTC9102 PSE chipset supports only 2-pair operation, but the DC3017A-B motherboard layout is specifi-

cally for 4-pair ports. Each 4-pair port must be physically split into two separate 2-pair ports using an Ethernet splitter such as Tripp Lite's N035-001 or a custom "Y-Cable". One N035-001 is included with the EVAL-LTC9101-2A and EVAL-LTC9101-2B for evaluation purposes.

An Ethernet splitter splits the pairsets from one RJ45 port at the PSE to two separate RJ45 ports that connect to two separate PDs. An Ethernet splitter is required for each RJ45 port on the EVAL-LTC9101-2A/EVAL-LTC9101-2B. Figure 9 shows a "Y-Cable" that connects Alternative A from the EVAL-LTC9101-2A/EVAL-LTC9101-2B (pairs 1, 2 and 3, 6) to the Alternative A of one PD, and connects Alternative B from the EVAL-LTC9101-2A/EVAL-LTC9101-2B (pairs 4, 5 and 7, 8) to Alternative B for the second PD. The odd port is Alternative A, while the even port is Alternative B.

The LTC9101-2A/LTC9102 PSE chipset requires host control over I²C. A DC590 connected to J1 on the motherboard allows for I²C configuration via the users PC. For more information contact [Analog Devices Applications](#).

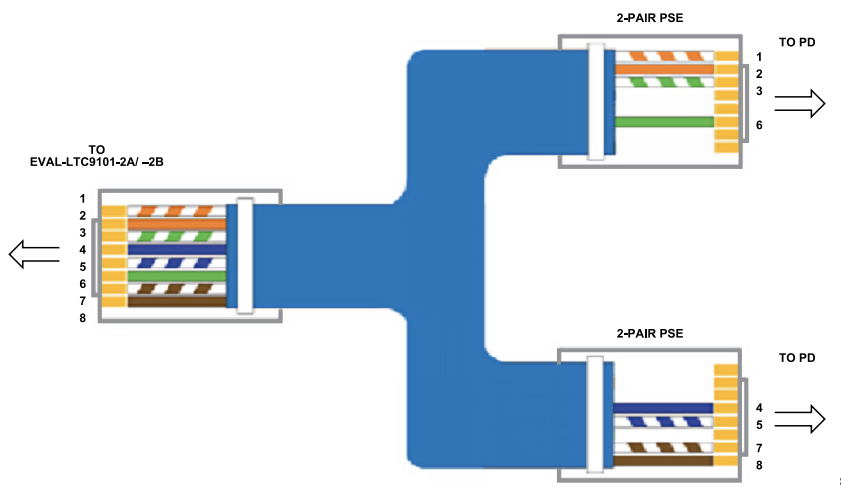

Figure 9. Example Connections and Pin-Out for Ethernet Splitter or "Y-Cable"

NOTES

**ESD Caution**

ESD (electrostatic discharge) sensitive device. Charged devices and circuit boards can discharge without detection. Although this product features patented or proprietary protection circuitry, damage may occur on devices subjected to high energy ESD. Therefore, proper ESD precautions should be taken to avoid performance degradation or loss of functionality.

Legal Terms and Conditions

By using the evaluation board discussed herein (together with any tools, components documentation or support materials, the "Evaluation Board"), you are agreeing to be bound by the terms and conditions set forth below ("Agreement") unless you have purchased the Evaluation Board, in which case the Analog Devices Standard Terms and Conditions of Sale shall govern. Do not use the Evaluation Board until you have read and agreed to the Agreement. Your use of the Evaluation Board shall signify your acceptance of the Agreement. This Agreement is made by and between you ("Customer") and Analog Devices, Inc. ("ADI"), with its principal place of business at Subject to the terms and conditions of the Agreement, ADI hereby grants to Customer a free, limited, personal, temporary, non-exclusive, non-sublicensable, non-transferable license to use the Evaluation Board FOR EVALUATION PURPOSES ONLY. Customer understands and agrees that the Evaluation Board is provided for the sole and exclusive purpose referenced above, and agrees not to use the Evaluation Board for any other purpose. Furthermore, the license granted is expressly made subject to the following additional limitations: Customer shall not (i) rent, lease, display, sell, transfer, assign, sublicense, or distribute the Evaluation Board; and (ii) permit any Third Party to access the Evaluation Board. As used herein, the term "Third Party" includes any entity other than ADI, Customer, their employees, affiliates and in-house consultants. The Evaluation Board is NOT sold to Customer; all rights not expressly granted herein, including ownership of the Evaluation Board, are reserved by ADI. CONFIDENTIALITY. This Agreement and the Evaluation Board shall all be considered the confidential and proprietary information of ADI. Customer may not disclose or transfer any portion of the Evaluation Board to any other party for any reason. Upon discontinuation of use of the Evaluation Board or termination of this Agreement, Customer agrees to promptly return the Evaluation Board to ADI. ADDITIONAL RESTRICTIONS. Customer may not disassemble, decompile or reverse engineer chips on the Evaluation Board. Customer shall inform ADI of any occurred damages or any modifications or alterations it makes to the Evaluation Board, including but not limited to soldering or any other activity that affects the material content of the Evaluation Board. Modifications to the Evaluation Board must comply with applicable law, including but not limited to the RoHS Directive. TERMINATION. ADI may terminate this Agreement at any time upon giving written notice to Customer. Customer agrees to return to ADI the Evaluation Board at that time. LIMITATION OF LIABILITY. THE EVALUATION BOARD PROVIDED HEREUNDER IS PROVIDED "AS IS" AND ADI MAKES NO WARRANTIES OR REPRESENTATIONS OF ANY KIND WITH RESPECT TO IT. ADI SPECIFICALLY DISCLAIMS ANY REPRESENTATIONS, ENDORSEMENTS, GUARANTEES, OR WARRANTIES, EXPRESS OR IMPLIED, RELATED TO THE EVALUATION BOARD INCLUDING, BUT NOT LIMITED TO, THE IMPLIED WARRANTY OF MERCHANTABILITY, TITLE, FITNESS FOR A PARTICULAR PURPOSE OR NON-INFRINGEMENT OF INTELLECTUAL PROPERTY RIGHTS. IN NO EVENT WILL ADI AND ITS LICENSORS BE LIABLE FOR ANY INCIDENTAL, SPECIAL, INDIRECT, OR CONSEQUENTIAL DAMAGES RESULTING FROM CUSTOMER'S POSSESSION OR USE OF THE EVALUATION BOARD, INCLUDING BUT NOT LIMITED TO LOST PROFITS, DELAY COSTS, LABOR COSTS OR LOSS OF GOODWILL. ADI'S TOTAL LIABILITY FROM ANY AND ALL CAUSES SHALL BE LIMITED TO THE AMOUNT OF ONE HUNDRED US DOLLARS (\$100.00). EXPORT. Customer agrees that it will not directly or indirectly export the Evaluation Board to another country, and that it will comply with all applicable United States federal laws and regulations relating to exports. GOVERNING LAW. This Agreement shall be governed by and construed in accordance with the substantive laws of the Commonwealth of Massachusetts (excluding conflict of law rules). Any legal action regarding this Agreement will be heard in the state or federal courts having jurisdiction in Suffolk County, Massachusetts, and Customer hereby submits to the personal jurisdiction and venue of such courts. The United Nations Convention on Contracts for the International Sale of Goods shall not apply to this Agreement and is expressly disclaimed.

