

## Evaluating the ADL8103 High Input Survivability, Low Noise Amplifier, 6 GHz to 12 GHz

### FEATURES

- ▶ 4-layer, Rogers 4350B and Isola 370HR evaluation board
- ▶ End launch, 2.92 mm RF connectors
- ▶ Through calibration path (depopulated)

### EVALUATION KIT CONTENTS

- ▶ ADL8103-EVALZ evaluation board

### EQUIPMENT NEEDED

- ▶ RF signal generator
- ▶ RF spectrum analyzer
- ▶ RF attenuator: 20 dB, 1 W
- ▶ RF coupler: 20 dB (optional)
- ▶ RF power meter and power sensor (optional)
- ▶ RF network analyzer
- ▶ 5 V, 300 mA power supply

### GENERAL DESCRIPTION

The ADL8103-EVALZ consists of a 4-layer printed circuit board (PCB) fabricated from 10 mil thick, Rogers 4350B and Isola 370HR, copper clad, forming a nominal thickness of 62 mils. The RFIN and RFOUT ports on the ADL8103-EVALZ are populated with 2.92 mm, female coaxial connectors, and the corresponding RF traces have a 50  $\Omega$  characteristic impedance. ADL8103-EVALZ is populated with components suitable for use over the entire  $-55^{\circ}\text{C}$  to  $+125^{\circ}\text{C}$  operating temperature range of the [ADL8103](#). To calibrate board trace losses, a through calibration path is provided between the J1 and J2 connectors. J1 and J2 must be populated with RF connectors to use the through calibration path. Refer to [Table 1](#) and [Figure 3](#) for the through calibration path performance.

Access the ADL8103-EVALZ ground path and VDD pin through the surface-mount technology (SMT) test point connectors, GND and VDD. A supplementary test point for VBIAS is included for simple access on the RBIAS pin (see [Figure 5](#) for the test point locations).

The RF traces on the ADL8103-EVALZ are 50  $\Omega$ , grounded, coplanar waveguide. The package ground leads and the exposed pad connect directly to the ground plane. Multiple vias connect the top and bottom ground planes with particular focus on the area directly beneath the ground paddle to provide adequate electrical conduction and thermal conduction.

The power supply decoupling capacitors on the ADL8103-EVALZ represent the configuration used to characterize and qualify the device.

For full details on the ADL8103, see the ADL8103 data sheet, which must be consulted in conjunction with this user guide when using the ADL8103-EVALZ.

### EVALUATION BOARD PHOTOGRAPHS

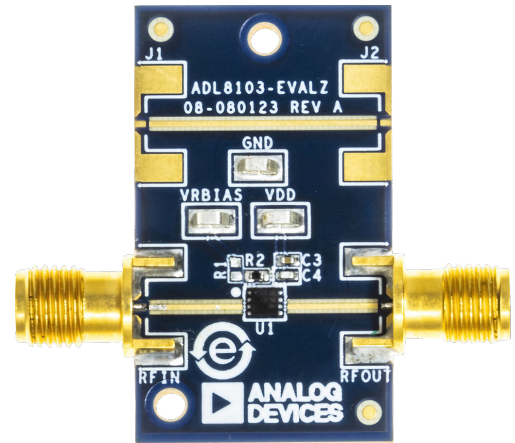

Figure 1. ADL8103-EVALZ Primary Side

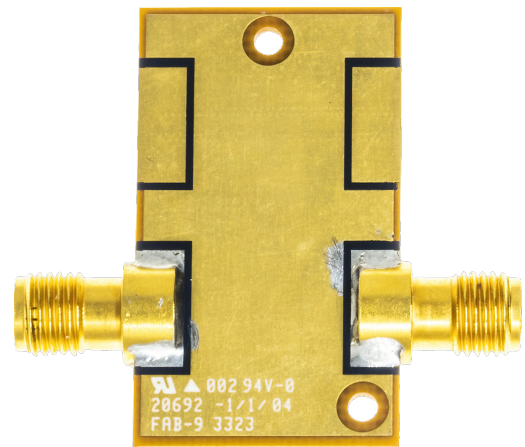

Figure 2. ADL8103-EVALZ Secondary Side

**TABLE OF CONTENTS**

Features.....	1	Operating the ADL8103-EVALZ.....	3
Evaluation Kit Contents.....	1	Recommended Bias Sequencing.....	3
Equipment Needed.....	1	Evaluation Board Schematic and Artwork.....	4
General Description.....	1	Ordering Information.....	5
Evaluation Board Photographs.....	1	Bill of Materials.....	5

**REVISION HISTORY**

**9/2024—Revision 0: Initial Version**

**OPERATING THE ADL8103-EVALZ**

A 5 V, 300 mA power supply is required to provide the bias to ADL8103 when using the ADL8103-EVALZ. Connect the 5 V power supply to the SMT test point, VDD. Connect the ground reference to the GND test point.

Refer to the ADL8103 data sheet for the recommended resistor values to achieve different supply currents. The default value of the external resistor, R2, connected on the ADL8103-EVALZ is 698 Ω, which is the same value used to characterize the ADL8103.

The following bias conditions are recommended to achieve the performance specified in the ADL8103 data sheet: power supply ( $V_{DD}$ ) = 5 V, total supply current ( $I_{DQ}$ ) = 100 mA, and bias resistance ( $R_{BIAS}$ ) = 698 Ω.

**RECOMMENDED BIAS SEQUENCING**

**During Power-Up**

To power up the ADL8103-EVALZ, take the following bias sequencing steps:

1. Connect the VDD power supply.
2. Set the VDD supply to 5 V.
3. Apply the RF input signal.

**During Power-Down**

To power down the ADL8103-EVALZ, take the following bias sequencing steps:

1. Turn off the RF input signal.
2. Set the VDD supply to 0 V.

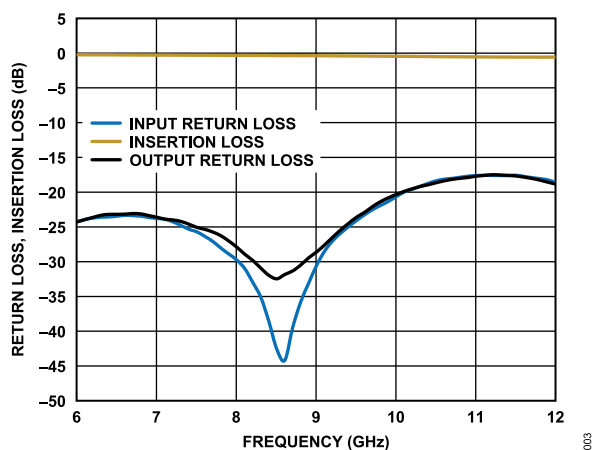

Figure 3. Insertion Loss and Return Loss of the Through Calibration Path

Table 1. Insertion Loss of the Through Calibration Path

Frequency (GHz)	Insertion Loss (dB)
6	-0.24
6.5	-0.27
7	-0.3
7.5	-0.31

Table 1. Insertion Loss of the Through Calibration Path (Continued)

Frequency (GHz)	Insertion Loss (dB)
8	-0.34
8.5	-0.37
9	-0.39
9.5	-0.42
10	-0.48
10.5	-0.52
11	-0.57
11.5	-0.6
12	-0.6

**Test Setup Diagrams**

The following figures show the power and S-parameter test setups, respectively.

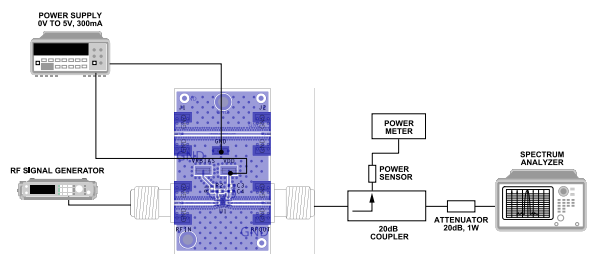

Figure 4. Power Test Equipment Setup

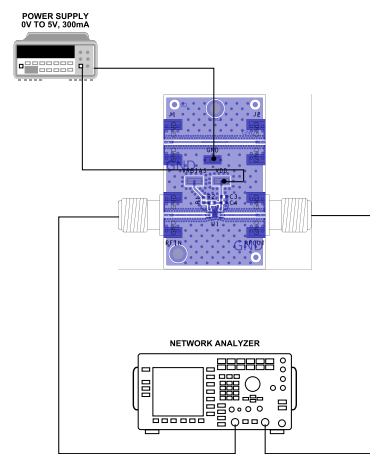

Figure 5. S-Parameter Test Equipment Setup

EVALUATION BOARD SCHEMATIC AND ARTWORK

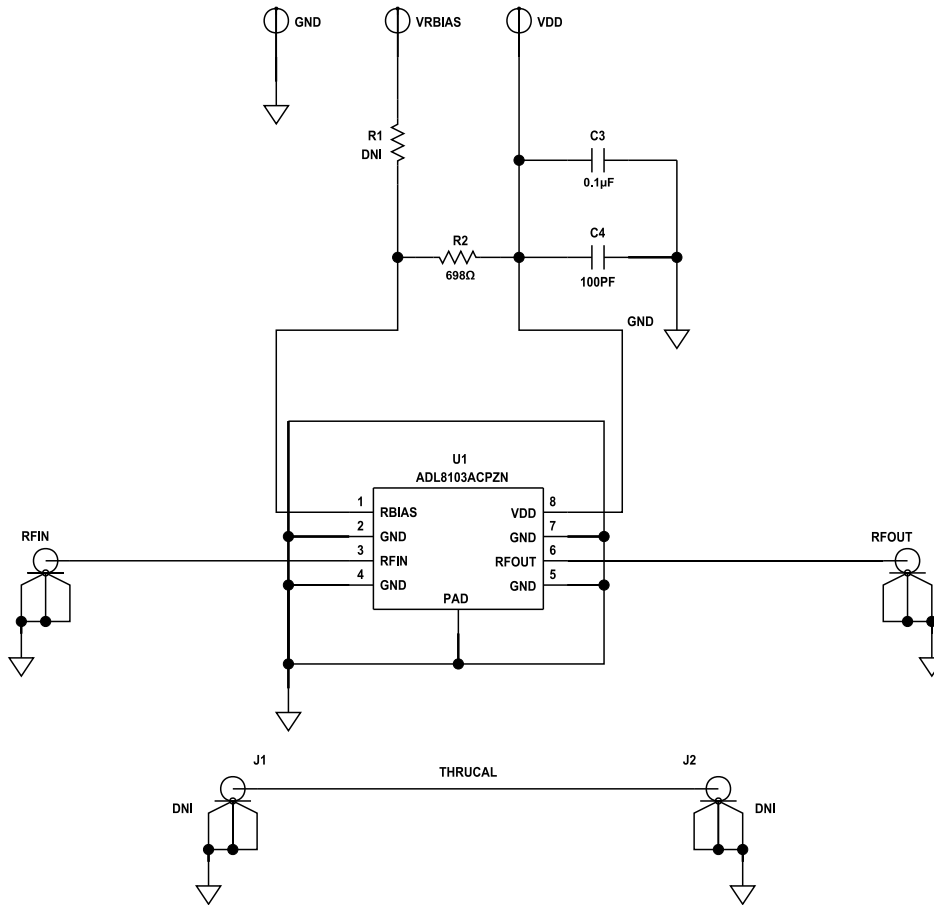

Figure 6. ADL8103-EVALZ Schematic

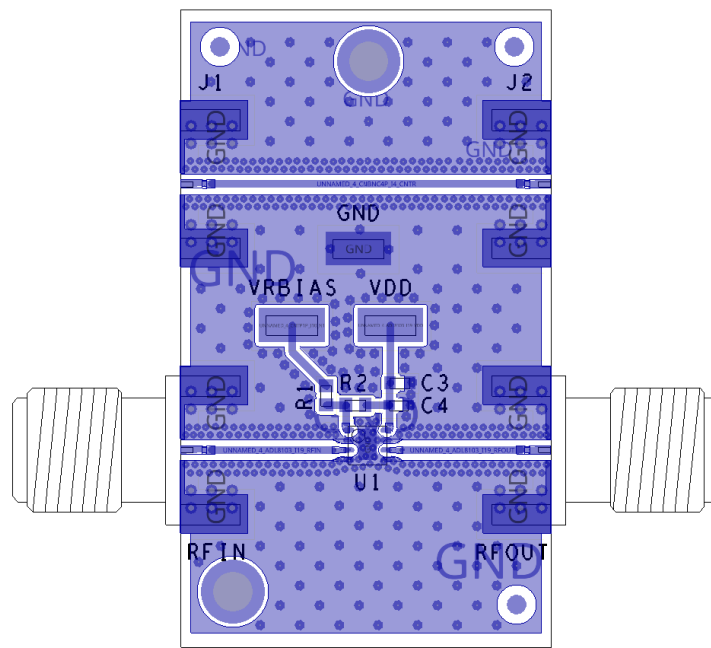

Figure 7. ADL8103-EVALZ Assembly Drawing (J1 and J2 Are Not Installed)

## ORDERING INFORMATION

## BILL OF MATERIALS

Table 2. Bill of Materials

Reference Designator	Description	Manufacturer	Part Number
C3	Capacitor, ceramic, 0.1 $\mu$ F, 16 V, 10%, X7R, 0402	Samsung	CL05B104KO5NNNC
C4	Capacitor, ceramic, 100 pF, 50 V, 5%, COG, 0402, extreme low, effective series resistance (ESR)	KEMET	C0402C101J5GACTU
VDD, GND, VRBIAS	Connectors, SMT test points	Keystone Electronics	5015
RFIN, RFOUT	Connectors, 2.92 mm, jack edge	Winchester Interconnect	25-146-1000-92
J1, J2	Connectors, 2.92 mm, jack edge, (not installed)	Winchester Interconnect	25-146-1000-92
R2	Resistor, 698 $\Omega$ , 0.1%, 1/16 W, 0402, AEC-Q200	Panasonic	ERA-2AEB6980X
R1	Resistor, surface mount device (SMD), 0 $\Omega$ jumper, 1/10 W, 0402, AEC-Q200 (not installed)	Panasonic	ERJ-2GE0R00X
U1	High input survivability, low noise amplifier, 6 GHz to 12 GHz	Analog Devices, Inc.	<a href="#">ADL8103ACPZN</a>

**ESD Caution**

**ESD (electrostatic discharge) sensitive device.** Charged devices and circuit boards can discharge without detection. Although this product features patented or proprietary protection circuitry, damage may occur on devices subjected to high energy ESD. Therefore, proper ESD precautions should be taken to avoid performance degradation or loss of functionality.

**Legal Terms and Conditions**

By using the evaluation board discussed herein (together with any tools, components documentation or support materials, the "Evaluation Board"), you are agreeing to be bound by the terms and conditions set forth below ("Agreement") unless you have purchased the Evaluation Board, in which case the Analog Devices Standard Terms and Conditions of Sale shall govern. Do not use the Evaluation Board until you have read and agreed to the Agreement. Your use of the Evaluation Board shall signify your acceptance of the Agreement. This Agreement is made by and between you ("Customer") and Analog Devices, Inc. ("ADI"), with its principal place of business at Subject to the terms and conditions of the Agreement, ADI hereby grants to Customer a free, limited, personal, temporary, non-exclusive, non-sublicensable, non-transferable license to use the Evaluation Board FOR EVALUATION PURPOSES ONLY. Customer understands and agrees that the Evaluation Board is provided for the sole and exclusive purpose referenced above, and agrees not to use the Evaluation Board for any other purpose. Furthermore, the license granted is expressly made subject to the following additional limitations: Customer shall not (i) rent, lease, display, sell, transfer, assign, sublicense, or distribute the Evaluation Board; and (ii) permit any Third Party to access the Evaluation Board. As used herein, the term "Third Party" includes any entity other than ADI, Customer, their employees, affiliates and in-house consultants. The Evaluation Board is NOT sold to Customer; all rights not expressly granted herein, including ownership of the Evaluation Board, are reserved by ADI. CONFIDENTIALITY. This Agreement and the Evaluation Board shall all be considered the confidential and proprietary information of ADI. Customer may not disclose or transfer any portion of the Evaluation Board to any other party for any reason. Upon discontinuation of use of the Evaluation Board or termination of this Agreement, Customer agrees to promptly return the Evaluation Board to ADI. ADDITIONAL RESTRICTIONS. Customer may not disassemble, decompile or reverse engineer chips on the Evaluation Board. Customer shall inform ADI of any occurred damages or any modifications or alterations it makes to the Evaluation Board, including but not limited to soldering or any other activity that affects the material content of the Evaluation Board. Modifications to the Evaluation Board must comply with applicable law, including but not limited to the RoHS Directive. TERMINATION. ADI may terminate this Agreement at any time upon giving written notice to Customer. Customer agrees to return to ADI the Evaluation Board at that time. LIMITATION OF LIABILITY. THE EVALUATION BOARD PROVIDED HEREUNDER IS PROVIDED "AS IS" AND ADI MAKES NO WARRANTIES OR REPRESENTATIONS OF ANY KIND WITH RESPECT TO IT. ADI SPECIFICALLY DISCLAIMS ANY REPRESENTATIONS, ENDORSEMENTS, GUARANTEES, OR WARRANTIES, EXPRESS OR IMPLIED, RELATED TO THE EVALUATION BOARD INCLUDING, BUT NOT LIMITED TO, THE IMPLIED WARRANTY OF MERCHANTABILITY, TITLE, FITNESS FOR A PARTICULAR PURPOSE OR NON-INFRINGEMENT OF INTELLECTUAL PROPERTY RIGHTS. IN NO EVENT WILL ADI AND ITS LICENSORS BE LIABLE FOR ANY INCIDENTAL, SPECIAL, INDIRECT, OR CONSEQUENTIAL DAMAGES RESULTING FROM CUSTOMER'S POSSESSION OR USE OF THE EVALUATION BOARD, INCLUDING BUT NOT LIMITED TO LOST PROFITS, DELAY COSTS, LABOR COSTS OR LOSS OF GOODWILL. ADI'S TOTAL LIABILITY FROM ANY AND ALL CAUSES SHALL BE LIMITED TO THE AMOUNT OF ONE HUNDRED US DOLLARS (\$100.00). EXPORT. Customer agrees that it will not directly or indirectly export the Evaluation Board to another country, and that it will comply with all applicable United States federal laws and regulations relating to exports. GOVERNING LAW. This Agreement shall be governed by and construed in accordance with the substantive laws of the Commonwealth of Massachusetts (excluding conflict of law rules). Any legal action regarding this Agreement will be heard in the state or federal courts having jurisdiction in Suffolk County, Massachusetts, and Customer hereby submits to the personal jurisdiction and venue of such courts. The United Nations Convention on Contracts for the International Sale of Goods shall not apply to this Agreement and is expressly disclaimed.

