

Evaluation Board for AD8280 Lithium Ion Battery Safety Monitor

FEATURES

- Full featured evaluation board for the AD8280
- Standalone capability
- Isolators on board

GENERAL DESCRIPTION

This user guide describes the evaluation boards for the [AD8280](#), which is a complete back-up monitor for lithium ion battery monitoring, integrating multiple voltages, and temperature input channels. Full details of the part, its specifications and its operating parameters are available in the AD8280 data sheet available from Analog Devices Inc., and should be consulted in conjunction with this user guide when using the evaluation board.

EVALUATION BOARD CONNECTION DIAGRAM

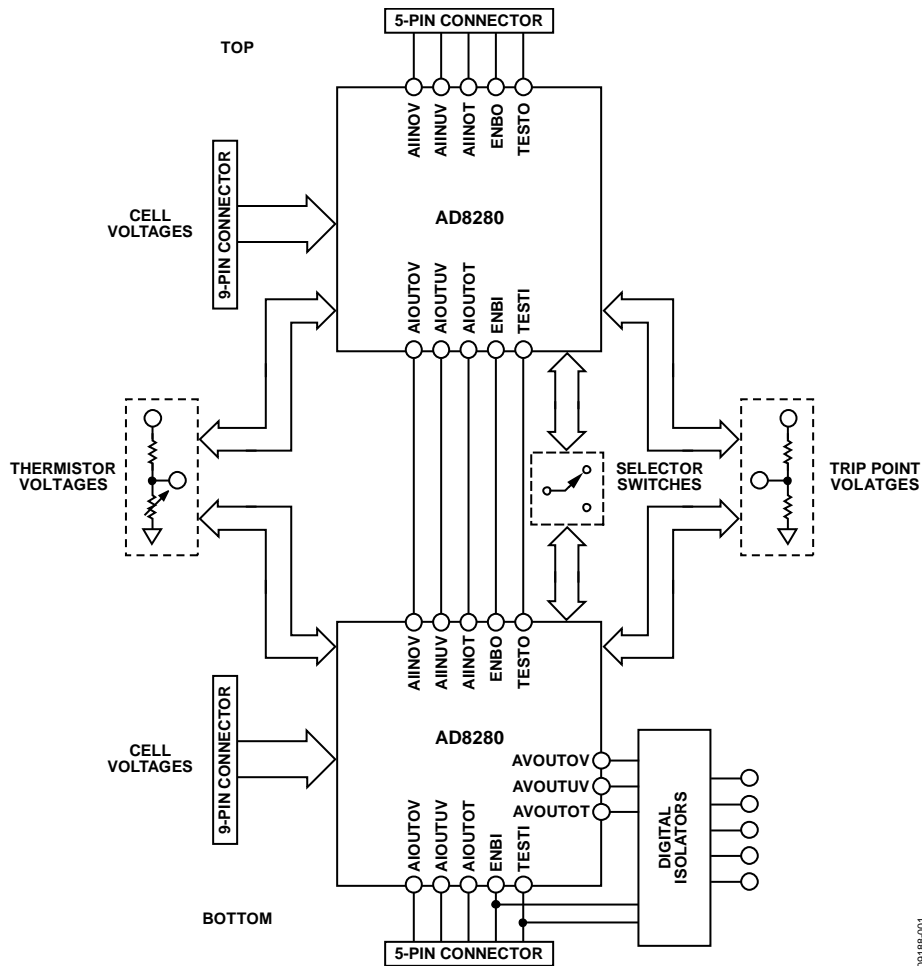

Figure 1.

09168-001

TABLE OF CONTENTS

Features	1	Selector Pin Options	3
General Description	1	Power Supply Connections	3
Evaluation Board Connection Diagram	1	Connecting Multiple Boards.....	3
Revision History	2	Schematics/Layout Drawings/Bill of Materials	3
Evaluation Board Hardware.....	3	Selector Switch Options.....	4
Battery Connections	3	Evaluation Board Schematics and Artwork	5
Thermistor Inputs	3	Ordering Information.....	9
Inputs and Outputs	3	Bill of Materials.....	9

REVISION HISTORY

6/10—Revision 0: Initial Version

EVALUATION BOARD HARDWARE

BATTERY CONNECTIONS

The AD8280 evaluation board contains two daisy-chained AD8280s and the necessary support components. Connector P1 and Connector P2 (9-pin connectors) are used to connect to the 12 battery cells. The six highest potential cells connect to P1 (near the 8280 TOP label in Figure 4) while the six lowest potential cells connect to P2 (near the 8280 BOTTOM label in Figure 4).

Pin 9 and Pin 8 of P1 and Pin 9 and Pin 8 of P2 connect to the highest potential cells of each six-cell stack, respectively. While Pin 1 and Pin 2 of P1 and Pin 1 and Pin 2 of P2 connect to the lowest potential cells of each six cell stack, respectively.

THERMISTOR INPUTS

Thermistor inputs are simulated with resistor dividers on the board (R8/R9, R10/R11, R36/R37, and R38/R39). If the user so chooses, either NTC or PTC thermistors could be substituted for R9, R11, R37, or R39. When doing so, the resistance values of R8, R10, R36, and R38 may need to be adjusted to ensure that the inputs stay within the allowable range of the overtemperature (OT) trip point settings over the temperature range of interest.

INPUTS AND OUTPUTS

The alarm outputs, AVOUTOV, AVOUTUV, and AVOUTOT, are available on the low voltage side of the isolators at the ALRM_OV, ALRM_UV, and ALRM_OT connectors, respectively. Inputs for TESTI and ENBI should be brought in through the TEST_IN and ENBL_IN connectors, respectively, also on the low voltage side of the isolators.

SELECTOR PIN OPTIONS

Refer to Table 1 and Table 2, as well as the AD8280 data sheet, to determine the position of the selector pins for various configurations. One option available that is not described on the data sheet is the ability to power up the thermistor divider with either the REF output or the LDO output at the selector pins labeled TOT and BOT (see Table 2).

POWER SUPPLY CONNECTIONS

Power for the AD8280s is supplied via the battery connections. Power for the high voltage side of the isolators is supplied by the LDO output of the AD8280. The 5 V power for the low voltage side of the isolators must be supplied by the user.

CONNECTING MULTIPLE BOARDS

Multiple boards can be daisy-chained via the P21 and P22 connectors if the user desires to work with more than 12 cells. When connecting multiple boards together, CR10 to CR14 must be added to the appropriate locations adjacent to P22 (see Figure 2).

SCHEMATICS/LAYOUT DRAWINGS/BILL OF MATERIALS

Schematics for the AD8280 evaluation board are shown in Figure 2 and Figure 3.

Layout drawings are shown in Figure 4, Figure 5, and Figure 6.

The bill of materials for the board is shown in Table 6.

SELECTOR SWITCH OPTIONS

Table 1. Programming Selector Pins

Selector Pin ¹	High	Low
xNPTC	Selects positive temperature coefficient thermistor	Selects negative temperature coefficient thermistor
xALRMSEL	Selects three separate alarms	Selects one shared alarm
xDGT2, xDGT1, xDGT0	Refer to Table 5	Refer to Table 5
xSELO, xSEL1	Refer to Table 3	Refer to Table 3
xTOP, xBOT	Refer to Table 4	Refer to Table 4

¹ x = T for top part or B for bottom part.

Table 2. Programming xOT Selector Pins

Selector Pin ¹	LDO	REF
xOT	Select to power the OT trip point divider by the LDO	Select to power the OT trip point divider by the REF

¹ x = T for top part or B for bottom part.

Table 3. SELx Pin Programming

Desired Condition	SELO	SEL1
6 Cells	0	0
5 Cells (VIN5 Shorted)	0	1
4 Cells (VIN4 and VIN5 Shorted)	1	0
3 Cells (VIN3, VIN4, and VIN5 Shorted)	1	1

Table 4. Top/Bottom Part in Daisy-Chain Designation

Desired Condition	TOP ¹	BOT ¹
Middle Potential Part	0	0
Part at Lowest Potential	0	1
Part at Highest Potential	1	0
Single Part (Both Highest and Lowest Potential)	1	1

¹ For TOP and BOT only, Logic 0 is VBOT, and Logic 1 is VTOP.

Table 5. Fault Detection Time Pin Programming

Desired Condition	DGT0	DGT1	DGT2
0.0 sec	0	0	0
0.1 sec	0	0	1
0.8 sec	0	1	0
1.6 sec	0	1	1
3.2 sec	1	0	0
6.4 sec	1	0	1
12.8 sec	1	1	0

EVALUATION BOARD SCHEMATICS AND ARTWORK

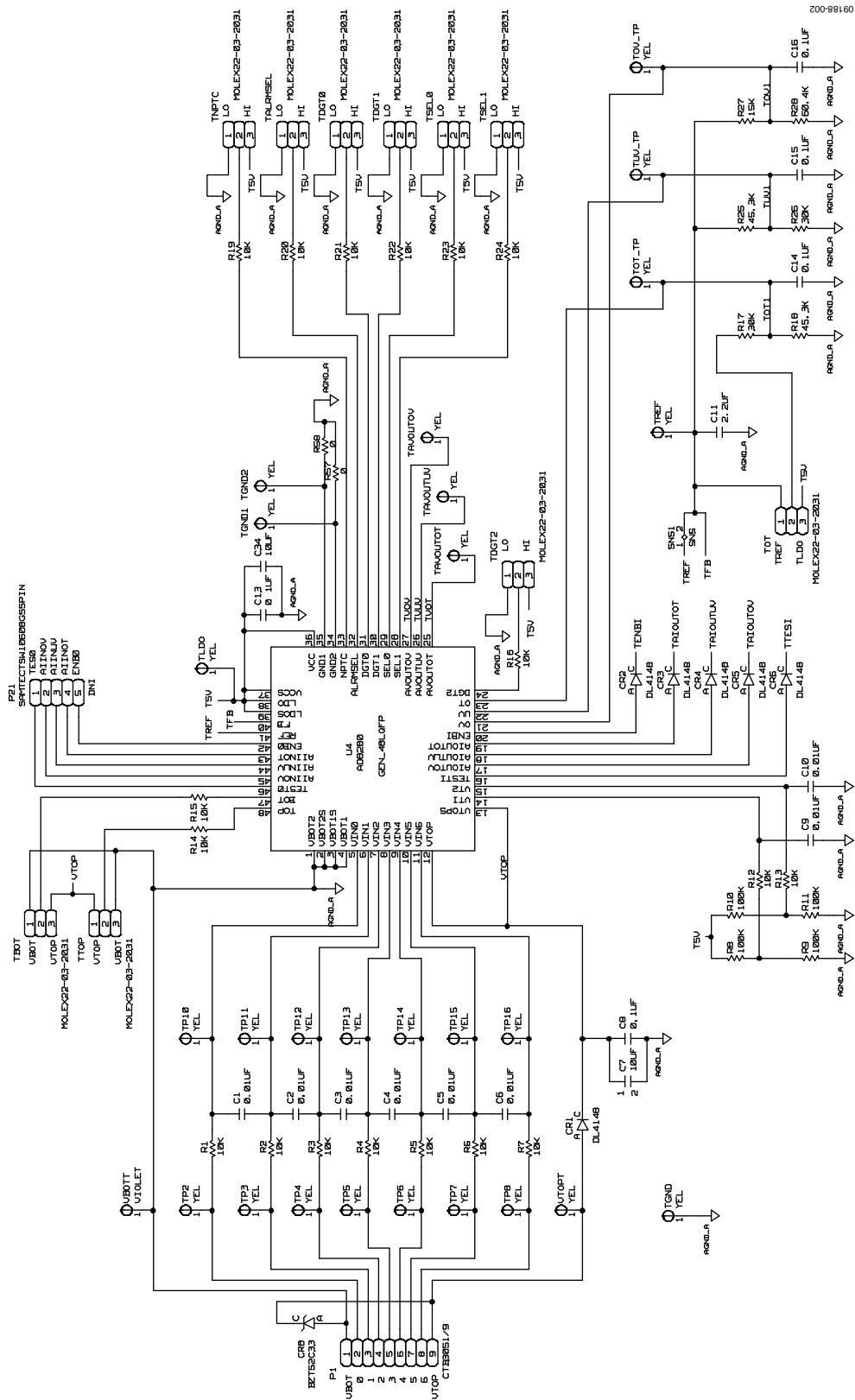

Figure 2. Schematic for U4 Circuit Labeled TOP Device

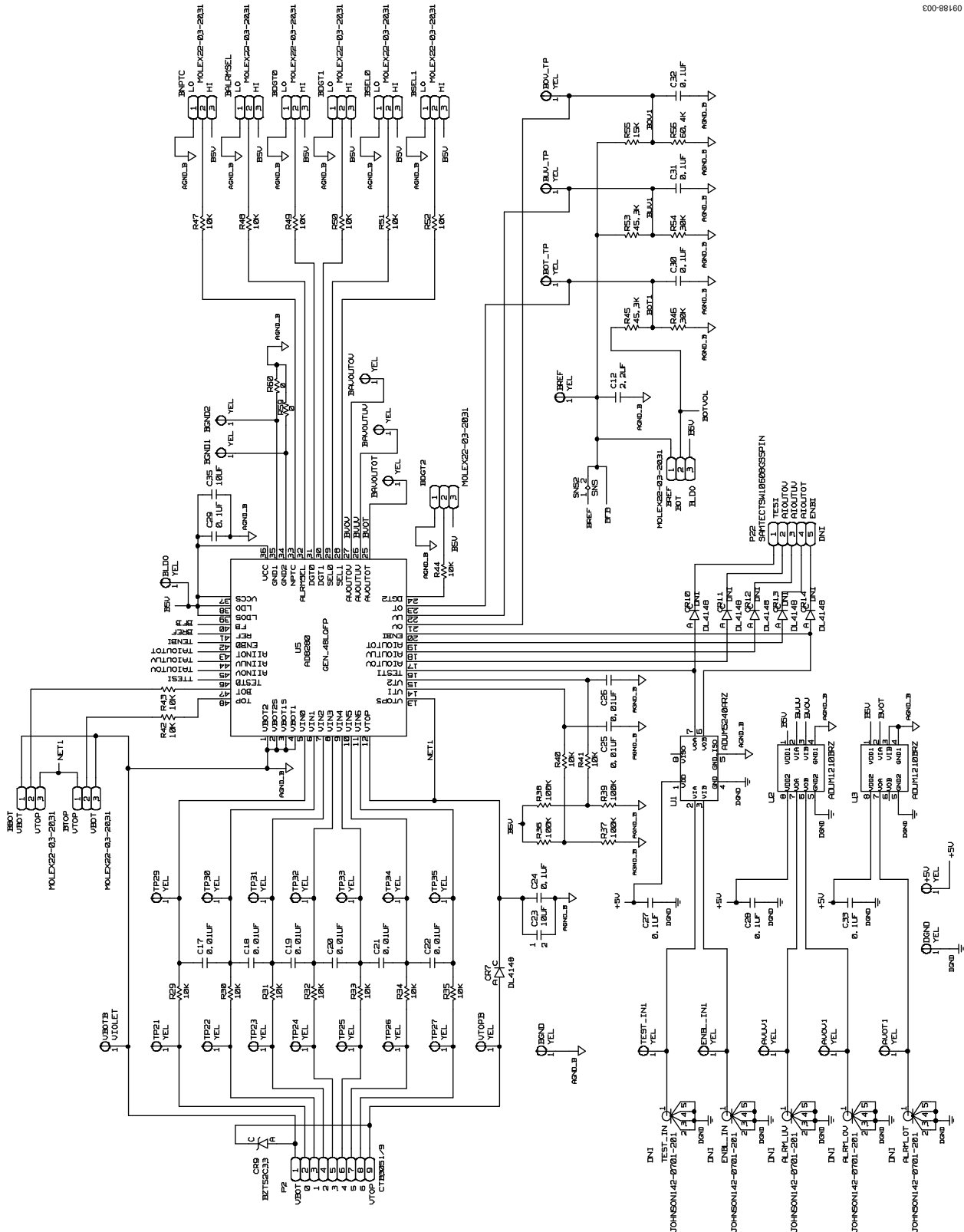

Figure 3. Schematic for U5 Circuit Labeled BOTTOM Device

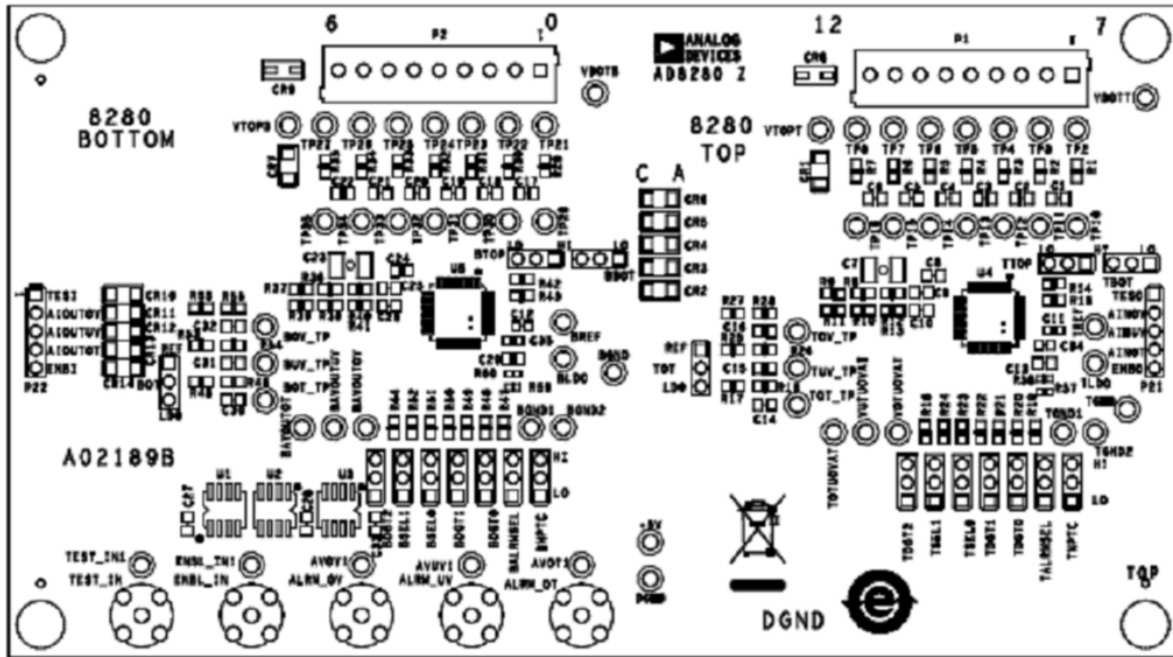

Figure 4. Component Layout of Evaluation Board

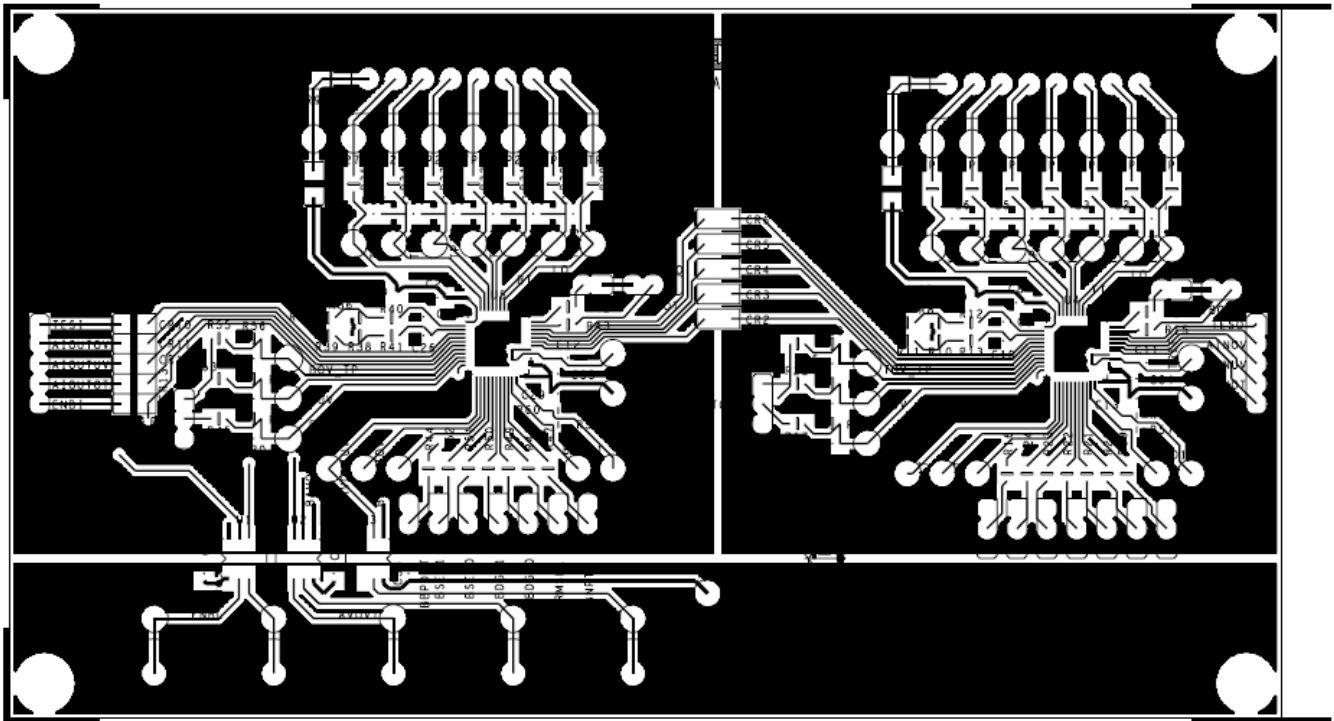

Figure 5. Board Connections—Top Layer of Evaluation Board

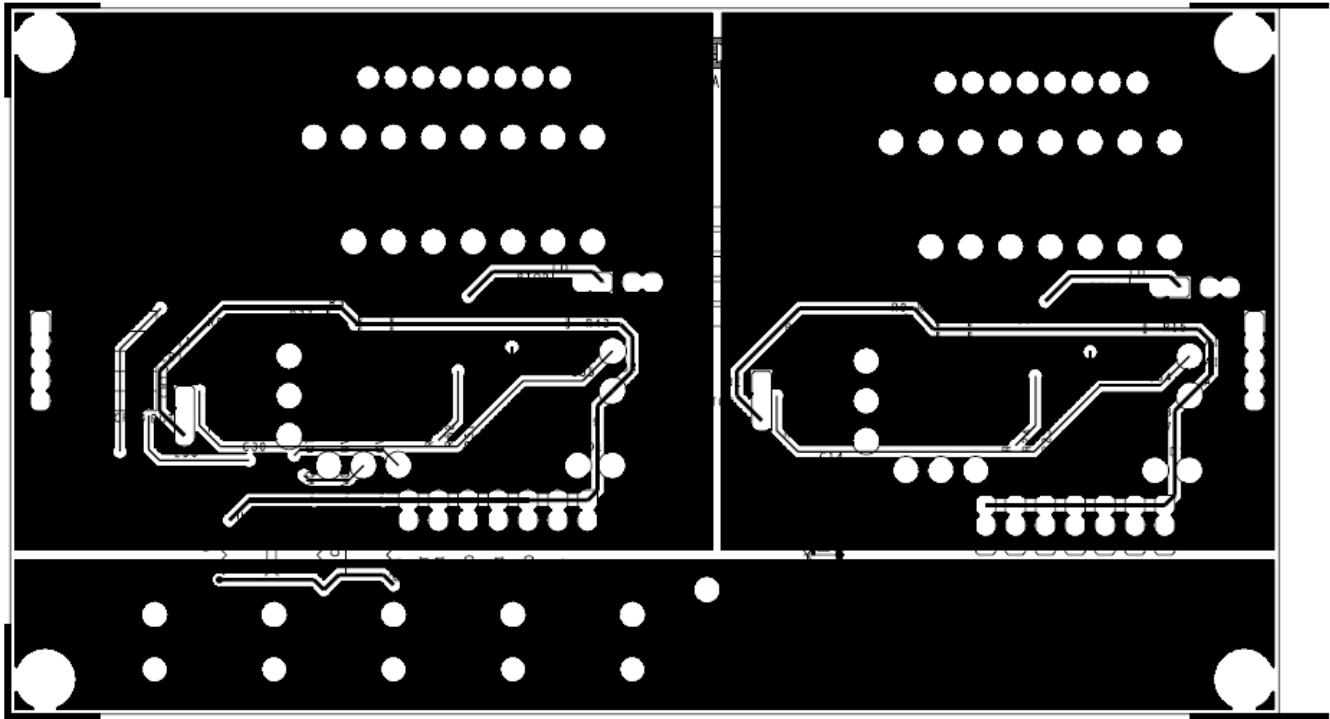

Figure 6. Board Connections—Bottom Layer of Evaluation Board

09185-006

ORDERING INFORMATION**BILL OF MATERIALS**

Table 6.

Qty	Reference Designator	Description	Manufacturer	Manufacturer Product No.
16	C1 to C6, C9, C10, C17 to C22, C25, C26	0.01 μ F ceramic PPS capacitor	Panasonic	ECH-U1C103JB5
2	C11, C12	2.2 μ F, 0603, X5R capacitor	Panasonic	ECJ-1VB0J225K
13	C8, C13 to C16, C24, C27 to C33	0.1 μ F ceramic, X7R capacitor	Panasonic	ECJ-2YB1H104K
2	C7, C23	10 μ F ceramic capacitor	Panasonic	ECJ-5YF1V106Z
2	C34, C35	10 μ F, 0603, X5R capacitor	Panasonic	ECJ-1VB0J106M
7	CR1 to CR7	Diode signal DL4148	Microsemi Corp.	DL4148
2	CR8, CR9	33 V Zener diode	Diodes, Inc.	BZT52C33
2	P1, P2	Connector, PCB 3.5 mm, ultralow profile, screw termination	Camden Electronics, Ltd.	CTB3051/9
36	R1 to R7, R12 to R16, R19 to R24, R29 to R35, R40 to R44, R47 to R52	10 k Ω , precision thick film chip, 0805 resistor	Panasonic	ERJ-6ENF1002V
8	R8 to R11, R36 to R39	100 k Ω , precision thick film chip, 0805 resistor	Panasonic	ERJ-6ENF1003V
4	R17, R26, R46, R54	30 k Ω , film SMD, 0805 resistor	Panasonic	ERA-6YEB30K
4	R18, R25, R45, R53	45.3 k Ω , precision thick film chip, 0805 resistor	Panasonic	ERJ-6ENF4532V
2	R27, R55	15 k Ω , film SMD, 0805 resistor	Panasonic	ERA-6YEB153V
2	R28, R56	60.4 k Ω , precision thick film chip, 0805 resistor	Panasonic	ERJ-6ENF6042V
4	R57 to R60	0 Ω film, SMD, 0402 resistor	Panasonic	ERJ-2GE0R00X
1	U1	IC dual-channel isoPower [®] isolator	Analog Devices, Inc.	ADuM5240ARZ
2	U2, U3	IC dual-channel D isolator	Analog Devices, Inc.	ADuM1210BRZ
2	U4, U5	Lithium ion battery safety monitor	Analog Devices, Inc.	AD8280WASTZ

NOTES

NOTES

NOTES

**ESD Caution**

ESD (electrostatic discharge) sensitive device. Charged devices and circuit boards can discharge without detection. Although this product features patented or proprietary protection circuitry, damage may occur on devices subjected to high energy ESD. Therefore, proper ESD precautions should be taken to avoid performance degradation or loss of functionality.

Legal Terms and Conditions

By using the evaluation board discussed herein (together with any tools, components documentation or support materials, the "Evaluation Board"), you are agreeing to be bound by the terms and conditions set forth below ("Agreement") unless you have purchased the Evaluation Board, in which case the Analog Devices Standard Terms and Conditions of Sale shall govern. Do not use the Evaluation Board until you have read and agreed to the Agreement. Your use of the Evaluation Board shall signify your acceptance of the Agreement. This Agreement is made by and between you ("Customer") and Analog Devices, Inc. ("ADI"), with its principal place of business at One Technology Way, Norwood, MA 02062, USA. Subject to the terms and conditions of the Agreement, ADI hereby grants to Customer a free, limited, personal, temporary, non-exclusive, non-sublicensable, non-transferable license to use the Evaluation Board FOR EVALUATION PURPOSES ONLY. Customer understands and agrees that the Evaluation Board is provided for the sole and exclusive purpose referenced above, and agrees not to use the Evaluation Board for any other purpose. Furthermore, the license granted is expressly made subject to the following additional limitations: Customer shall not (i) rent, lease, display, sell, transfer, assign, sublicense, or distribute the Evaluation Board; and (ii) permit any Third Party to access the Evaluation Board. As used herein, the term "Third Party" includes any entity other than ADI, Customer, their employees, affiliates and in-house consultants. The Evaluation Board is NOT sold to Customer; all rights not expressly granted herein, including ownership of the Evaluation Board, are reserved by ADI. CONFIDENTIALITY. This Agreement and the Evaluation Board shall all be considered the confidential and proprietary information of ADI. Customer may not disclose or transfer any portion of the Evaluation Board to any other party for any reason. Upon discontinuation of use of the Evaluation Board or termination of this Agreement, Customer agrees to promptly return the Evaluation Board to ADI. ADDITIONAL RESTRICTIONS. Customer may not disassemble, decompile or reverse engineer chips on the Evaluation Board. Customer shall inform ADI of any occurred damages or any modifications or alterations it makes to the Evaluation Board, including but not limited to soldering or any other activity that affects the material content of the Evaluation Board. Modifications to the Evaluation Board must comply with applicable law, including but not limited to the RoHS Directive. TERMINATION. ADI may terminate this Agreement at any time upon giving written notice to Customer. Customer agrees to return to ADI the Evaluation Board at that time. LIMITATION OF LIABILITY. THE EVALUATION BOARD PROVIDED HEREUNDER IS PROVIDED "AS IS" AND ADI MAKES NO WARRANTIES OR REPRESENTATIONS OF ANY KIND WITH RESPECT TO IT. ADI SPECIFICALLY DISCLAIMS ANY REPRESENTATIONS, ENDORSEMENTS, GUARANTEES, OR WARRANTIES, EXPRESS OR IMPLIED, RELATED TO THE EVALUATION BOARD INCLUDING, BUT NOT LIMITED TO, THE IMPLIED WARRANTY OF MERCHANTABILITY, TITLE, FITNESS FOR A PARTICULAR PURPOSE OR NON-INFRINGEMENT OF INTELLECTUAL PROPERTY RIGHTS. IN NO EVENT WILL ADI AND ITS LICENSORS BE LIABLE FOR ANY INCIDENTAL, SPECIAL, INDIRECT, OR CONSEQUENTIAL DAMAGES RESULTING FROM CUSTOMER'S POSSESSION OR USE OF THE EVALUATION BOARD, INCLUDING BUT NOT LIMITED TO LOST PROFITS, DELAY COSTS, LABOR COSTS OR LOSS OF GOODWILL. ADI'S TOTAL LIABILITY FROM ANY AND ALL CAUSES SHALL BE LIMITED TO THE AMOUNT OF ONE HUNDRED US DOLLARS (\$100.00). EXPORT. Customer agrees that it will not directly or indirectly export the Evaluation Board to another country, and that it will comply with all applicable United States federal laws and regulations relating to exports. GOVERNING LAW. This Agreement shall be governed by and construed in accordance with the substantive laws of the Commonwealth of Massachusetts (excluding conflict of law rules). Any legal action regarding this Agreement will be heard in the state or federal courts having jurisdiction in Suffolk County, Massachusetts, and Customer hereby submits to the personal jurisdiction and venue of such courts. The United Nations Convention on Contracts for the International Sale of Goods shall not apply to this Agreement and is expressly disclaimed.