

Evaluating Universal Precision High-Voltage Op Amps in SOIC Packages

FEATURES

Footprint for 8-pin SOIC with bottom thermal pad
Locations for passive filter components

GENERAL DESCRIPTION

The **EVALPRAHVOPAMP-1RZ** is an evaluation board that accommodates single op amps in SOIC packages. It provides the user with multiple choices and extensive flexibility for different applications circuits and configurations. This board is not intended to be used with high frequency components or high speed amplifiers; however, it provides the user with many combinations for various circuit types such as active filters, differential amplifiers, and external frequency compensation circuits. A few examples of application circuits are shown in this user guide.

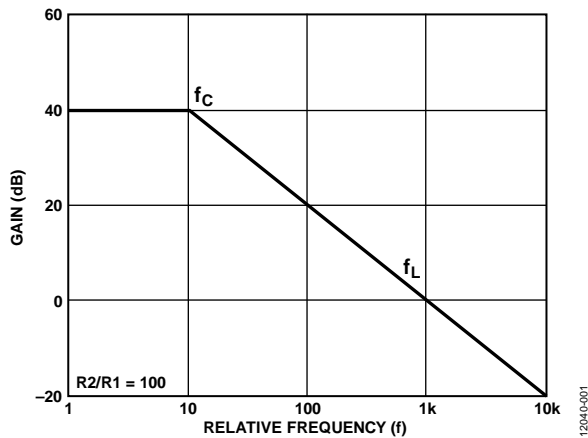
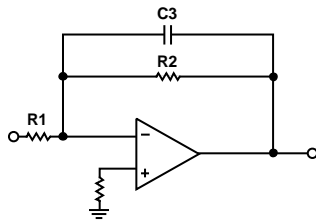

Figure 1. Simple Low-Pass Filter

LOW-PASS FILTER

Figure 1 is a typical representation of a first-order low-pass filter. This circuit has a 6 dB per octave roll-off after a closed loop -3 dB point defined by f_c . Gain below this frequency is defined as the magnitude of R_2 to R_1 . The circuit can be considered an ac integrator for frequencies well above f_c ; however, the time domain response is that of a single RC, rather than an integral.

$$f_c = 1/(2\pi \times R_2 \times C_3); -3 \text{ dB frequency}$$

$$f_L = 1/(2\pi \times R_1 \times C_3); \text{ unity gain frequency}$$

$$A_{CL} = -(R_2/R_1); \text{ closed loop gain}$$

Choose R_4 equal to the parallel combination between R_2 and R_1 in order to minimize errors due to bias currents.

DIFFERENCE AMPLIFIER AND PERFORMANCE OPTIMIZATION

Figure 2 shows an op amp configured as a difference amplifier. The difference amplifier is the complement of the summing amplifier, and allows the subtraction of two voltages or the cancellation of a signal common to both inputs. The circuit shown in

Figure 2 is useful as a computational amplifier in making a differential-to-single-ended conversion or in rejecting a common-mode signal. The output voltage V_{OUT} is comprised of two separate components:

1. A component V_{OUT1} due to V_{IN1} acting alone (V_{IN2} short-circuited to ground).
2. A component V_{OUT2} due to V_{IN2} acting alone (V_{IN1} short-circuited to ground).

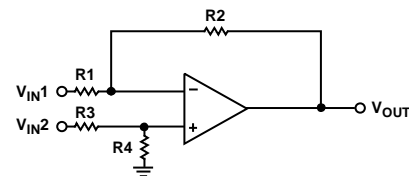

Figure 2. Difference Amplifier

The algebraic sum of these two components must be equal to V_{OUT} . By applying the principles expressed in the output voltage V_{OUT} components, and by letting $R_3 = R_1$ and $R_4 = R_2$, then:

$$V_{OUT1} = V_{IN1} R_2/R_1$$

$$V_{OUT2} = -V_{IN2} R_2/R_1$$

$$V_{OUT} = V_{OUT1} + V_{OUT2} = (V_{IN1} - V_{IN2}) R_2/R_1$$

Difference amplifiers are commonly used in high-accuracy circuits to improve the common-mode rejection ratio (CMRR).

For this type of application, CMRR depends upon how tightly matched resistors are used. Poorly matched resistors result in a low value of CMRR.

To see how this works, consider a hypothetical source of error for resistor R7 (1 - error). Using the superposition principle and letting R4 = R2 and R7 = R6, the output voltage is as follows:

$$V_{OUT} = \left\{ \frac{\left[\frac{R2}{R1} \left(1 - \frac{R1 + 2R2}{R1 + R2} \right) \times \frac{error}{2} \right]}{VD + \left(\frac{R2}{R1 + R2} \times error \right)} \right\}$$

$$V_{DD} = V_{IN2} - V_{IN1}$$

From this equation, A_{CM} and A_{DM} can be defined as follows:

$$A_{CM} = R2 / (R2 - R1) \times error$$

$$A_{DM} = R2 / R1 \times \{ 1 - [(R1 + 2R2 / R1 + R2) \times error / 2] \}$$

These equations demonstrate that when there is no error in the resistor values, the $A_{CM} = 0$ and the amplifier responds only to the differential voltage applied to its inputs. Under these conditions, the CMRR of the circuit is highly dependent on the CMRR of the amplifier selected for this job.

As mentioned above, errors introduced by resistor mismatch can be a big drawback of discrete differential amplifiers, but there are different ways to optimize this circuit configuration:

1. The differential gain is directly related to the ratio R2/R1. Therefore, one way to optimize the performance of this circuit is to place the amplifier in a high gain configuration. When larger values for resistors R2 and R4 and smaller values for resistors R1 and R3 are selected, the higher the gain, the higher the CMRR. For example, when R2 = R4 = 10 kΩ, and R1 = R3 = 1 kΩ, and error = 0.1%, CMRR improves to greater than 80 dB. For high gain configuration, select amplifiers with very low I_{BIAS} and very high gain (such as the [ADA4661-2](#), [ADA4610-2](#), and [AD8667](#)) to reduce errors.
2. Select resistors that have much tighter tolerance and accuracy. The more closely they are matched, the better the CMRR. For example, if a CMRR of 90 dB is needed, match resistors to approximately 0.02%.

CURRENT-TO-VOLTAGE CONVERTER

Current can be measured in two ways with an operational amplifier. Current can be converted to a voltage with a resistor and then amplified, or injected directly into a summing node.

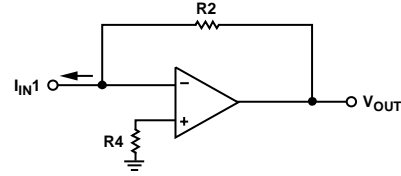

Figure 3. Current-to-Voltage Converter

Figure 3 is a typical representation of a current-to-voltage transducer. The input current is fed directly into the summing node and the amplifier output voltage changes to exactly the same current from the summing node through R2. The scale factor of this circuit is R2 volts per amp. The only conversion error in this circuit is I_{BIAS} , which is summed algebraically with I_{IN1} .

EXTERNAL COMPENSATION TECHNIQUES

Series Resistor Compensation

The use of external compensation networks is required to optimize certain applications. Figure 4 is a typical representation of a series resistor compensation for stabilizing an op amp driving capacitive load. The stabilizing effect of the series resistor isolates the op amp output and the feedback network from the capacitive load. The required amount of series resistance depends on the part used, but values of 5 Ω to 50 Ω are usually sufficient to prevent local resonance. The disadvantages of this technique are a reduction in gain accuracy and extra distortion when driving nonlinear loads.

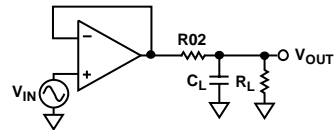

Figure 4. Series Resistor Compensation

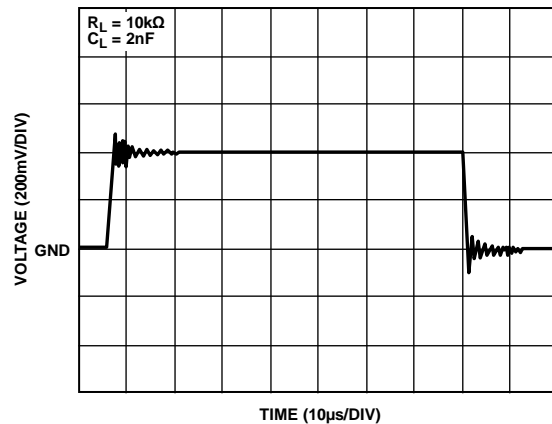

Figure 5. Capacitive Load Drive Without Resistor

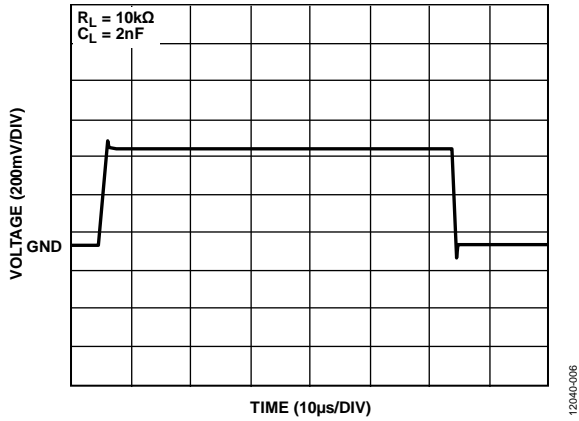

Figure 6. Capacitive Load Drive with Resistor

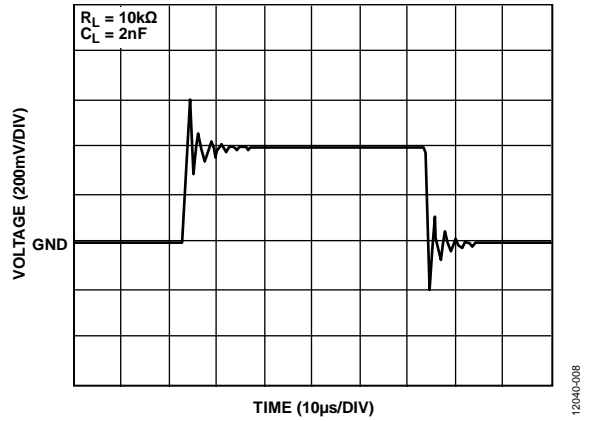

Figure 8. Capacitive Load Drive Without Snubber

Snubber Network

Another way to stabilize an op amp driving a capacitive load is with the use of a snubber, as shown in Figure 7. This method presents the significant advantage of not reducing the output swing because there is no isolation resistor in the signal path. Also, the use of the snubber does not degrade the gain accuracy or cause extra distortion when driving a nonlinear load. The exact R_s and C_s combinations can be determined experimentally.

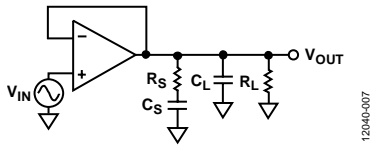

Figure 7. Snubber Network

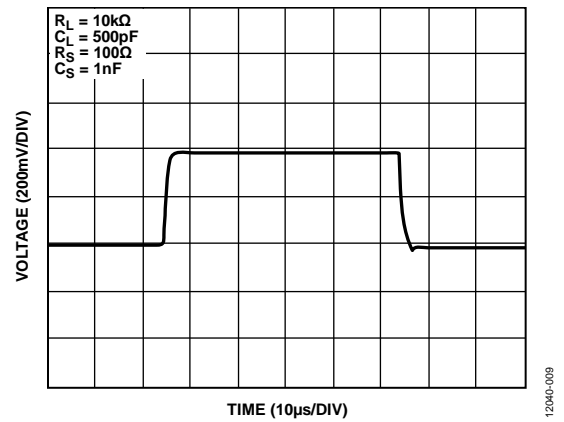

Figure 9. Capacitive Load Drive with Snubber

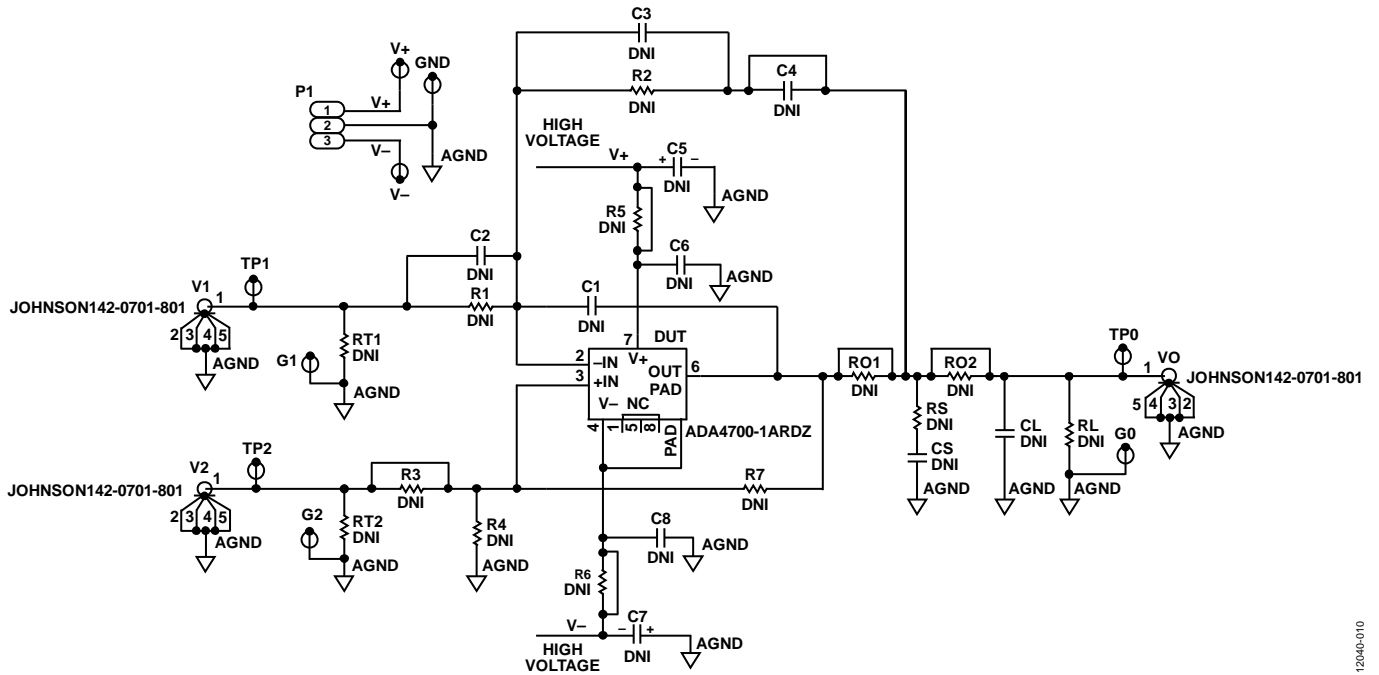

Figure 10. EVALPRAHVOPAMP-1RZ Electrical Schematic

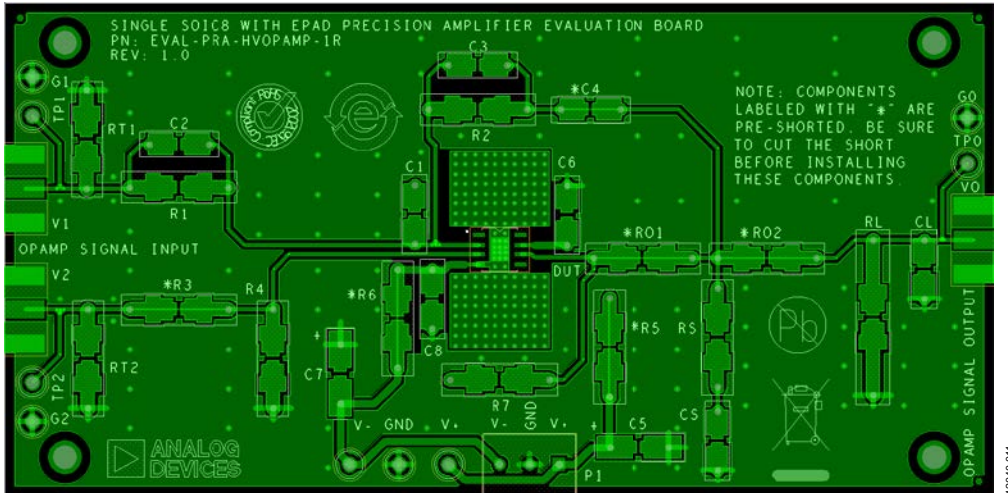

Figure 11. EVALPRAHVOPAMP-1RZ Board Layout Patterns

REVISION HISTORY

5/14—Rev. 0 to Rev. A

- Changes to Figure 1 and Figure 2..... 1
- Changes to Figure 3..... 2
- Changes to Figure 7 and Figure 10..... 3

2/14—Revision 0: Initial Version



ESD Caution

ESD (electrostatic discharge) sensitive device. Charged devices and circuit boards can discharge without detection. Although this product features patented or proprietary protection circuitry, damage may occur on devices subjected to high energy ESD. Therefore, proper ESD precautions should be taken to avoid performance degradation or loss of functionality.

Legal Terms and Conditions

By using the evaluation board discussed herein (together with any tools, components documentation or support materials, the "Evaluation Board"), you are agreeing to be bound by the terms and conditions set forth below ("Agreement") unless you have purchased the Evaluation Board, in which case the Analog Devices Standard Terms and Conditions of Sale shall govern. Do not use the Evaluation Board until you have read and agreed to the Agreement. Your use of the Evaluation Board shall signify your acceptance of the Agreement. This Agreement is made by and between you ("Customer") and Analog Devices, Inc. ("ADI"), with its principal place of business at One Technology Way, Norwood, MA 02062, USA. Subject to the terms and conditions of the Agreement, ADI hereby grants to Customer a free, limited, personal, temporary, non-exclusive, non-sublicensable, non-transferable license to use the Evaluation Board FOR EVALUATION PURPOSES ONLY. Customer understands and agrees that the Evaluation Board is provided for the sole and exclusive purpose referenced above, and agrees not to use the Evaluation Board for any other purpose. Furthermore, the license granted is expressly made subject to the following additional limitations: Customer shall not (i) rent, lease, display, sell, transfer, assign, sublicense, or distribute the Evaluation Board; and (ii) permit any Third Party to access the Evaluation Board. As used herein, the term "Third Party" includes any entity other than ADI, Customer, their employees, affiliates and in-house consultants. The Evaluation Board is NOT sold to Customer; all rights not expressly granted herein, including ownership of the Evaluation Board, are reserved by ADI. CONFIDENTIALITY. This Agreement and the Evaluation Board shall all be considered the confidential and proprietary information of ADI. Customer may not disclose or transfer any portion of the Evaluation Board to any other party for any reason. Upon discontinuation of use of the Evaluation Board or termination of this Agreement, Customer agrees to promptly return the Evaluation Board to ADI. ADDITIONAL RESTRICTIONS. Customer may not disassemble, decompile or reverse engineer chips on the Evaluation Board. Customer shall inform ADI of any occurred damages or any modifications or alterations it makes to the Evaluation Board, including but not limited to soldering or any other activity that affects the material content of the Evaluation Board. Modifications to the Evaluation Board must comply with applicable law, including but not limited to the RoHS Directive. TERMINATION. ADI may terminate this Agreement at any time upon giving written notice to Customer. Customer agrees to return to ADI the Evaluation Board at that time. LIMITATION OF LIABILITY. THE EVALUATION BOARD PROVIDED HEREUNDER IS PROVIDED "AS IS" AND ADI MAKES NO WARRANTIES OR REPRESENTATIONS OF ANY KIND WITH RESPECT TO IT. ADI SPECIFICALLY DISCLAIMS ANY REPRESENTATIONS, ENDORSEMENTS, GUARANTEES, OR WARRANTIES, EXPRESS OR IMPLIED, RELATED TO THE EVALUATION BOARD INCLUDING, BUT NOT LIMITED TO, THE IMPLIED WARRANTY OF MERCHANTABILITY, TITLE, FITNESS FOR A PARTICULAR PURPOSE OR NON-INFRINGEMENT OF INTELLECTUAL PROPERTY RIGHTS. IN NO EVENT WILL ADI AND ITS LICENSORS BE LIABLE FOR ANY INCIDENTAL, SPECIAL, INDIRECT, OR CONSEQUENTIAL DAMAGES RESULTING FROM CUSTOMER'S POSSESSION OR USE OF THE EVALUATION BOARD, INCLUDING BUT NOT LIMITED TO LOST PROFITS, DELAY COSTS, LABOR COSTS OR LOSS OF GOODWILL. ADI'S TOTAL LIABILITY FROM ANY AND ALL CAUSES SHALL BE LIMITED TO THE AMOUNT OF ONE HUNDRED US DOLLARS (\$100.00). EXPORT. Customer agrees that it will not directly or indirectly export the Evaluation Board to another country, and that it will comply with all applicable United States federal laws and regulations relating to exports. GOVERNING LAW. This Agreement shall be governed by and construed in accordance with the substantive laws of the Commonwealth of Massachusetts (excluding conflict of law rules). Any legal action regarding this Agreement will be heard in the state or federal courts having jurisdiction in Suffolk County, Massachusetts, and Customer hereby submits to the personal jurisdiction and venue of such courts. The United Nations Convention on Contracts for the International Sale of Goods shall not apply to this Agreement and is expressly disclaimed.

