

Evaluation Board for Programmable Single-Scan Waveform Generator

FEATURES

- Full-featured evaluation board for the [AD5932](#)
- USB cable for PC connection
- Can be powered entirely from USB port
- Various linking options
- PC software for control of [AD5932](#)
- On-board patchwork area

EVALUATION BOARD DESCRIPTION

The [EVAL-AD5932EBZ](#) is a full-featured evaluation board for the [AD5932](#) programmable single-scan waveform generator. The evaluation board interfaces to the USB port of a PC. It is possible to power the entire board using the USB port. Software is available with the [EVAL-AD5932EBZ](#), allowing users to easily program the [AD5932](#).

The [AD5932](#) evaluation board includes a 50 MHz oscillator that provides the MCLK for the [AD5932](#). The user can remove this oscillator, if required, and drive the [AD5932](#) with a different clock oscillator or an external clock source via a SMB connector.

AD5932 DEVICE DESCRIPTION

The [AD5932](#) is a waveform generator that allows the user to generate synthesized analog or digital frequency-stepped waveforms. Because frequency profiles are preprogrammed, continuous write cycles are eliminated, which frees up valuable DSP/microcontroller resources. Waveforms start from a known phase and increment phase continuously, allowing phase shifts to be easily determined. The device can be operated with clock frequencies of up to 50 MHz.

Complete specifications for the [AD5932](#) are available in the [AD5932](#) data sheet, available from Analog Devices, Inc., which should be consulted in conjunction with this user guide when using the evaluation board.

EVALUATION BOARD PHOTOGRAPH



Figure 1.

12024-001

TABLE OF CONTENTS

Features	1	Evaluation Board Software.....	4
Evaluation Board Description.....	1	Installing the Software	4
AD5932 Device Description	1	Using the Software	4
Evaluation Board Photograph.....	1	Evaluation Board Schematics and Artwork.....	6
Revision History	2	Ordering Information.....	9
Hardware Description.....	3	Bill of Materials.....	9
Power Supplies	3		
Link Options	3		

REVISION HISTORY

3/15—Rev. 0 to Rev. A

Reorganized Layout.....	Universal
Changes to Evaluation Board Description Section and Figure 1	1
Changes to Table 1	3
Changes to Evaluation Board Software Section, Figure 2, and Figure 3	4
Changes to Figure 4 to Figure 6.....	5

3/06—Revision 0: Initial Version

HARDWARE DESCRIPTION

POWER SUPPLIES

The [AD5932](#) has two analog power supply inputs: AVDD (analog VDD) and AGND (analog GND). There are also two digital supplies on the device: DVDD (digital VDD) and DGND (digital GND). Both of these supplies are independent of each other and can be powered from 2.3 V to 5.5 V.

As well as supplying the digital supply for the [AD5932](#), DVDD provides the supply for the 50 MHz oscillator and the [ADG774](#) quad 2:1 multiplexer.

There are two options available to power the [EVAL-AD5932EBZ](#) evaluation board:

- The USB port of a computer
- An external power supply

The default option for powering the board is from the USB port (LK1 and LK8 are in Position B). Alternatively, 2-pin terminal blocks are available for use with an external power supply.

The 5 V from the USB port is regulated to 3.3 V, which provides power for the CY7C68013 USB controller and related USB circuitry. The USB port also provides the GND connections for the evaluation board.

When LK1 is in Position B, DVDD is supplied with 3.3 V from the regulator. When LK8 is in Position B, AVDD is powered from DVDD through the L1 ferrite bead (600 Ω at 100 MHz). When LK1 and LK8 are in Position A, the terminal blocks provide power to the board.

To operate the device at a different supply than up to 3.3 V, use the terminal blocks. To abide by the maximum ratings of the [AD5932](#), use the [EVAL-AD5932EBZ](#) as a standalone board if operating at a voltage of less than 3 V. Therefore, SCLK, SDATA, FSYNC, CTRL, INTERRUPT, and STANDBY must be externally supplied by the user.

DGND and AGND are connected under the [AD5932](#). Therefore, it is recommended not to connect AGND and DGND elsewhere in the system. AVDD and DVDD are decoupled to the relevant ground plane using a 10 μ F tantalum capacitor and a 0.1 μ F ceramic capacitor at their source and again at the [AD5932](#).

LINK OPTIONS

Set the link options on the evaluation board for the required operating setup before using the board. The functions of these links are described in Table 1.

Table 1. Link Options

Link No.	Function Description	Default
LK1	This link selects the power supply source for the digital circuitry (DVDD). Position A selects J2 as the digital circuitry power supply source. Position B selects the 3.3 V from the ADP3303 regulator that is powered from the USB port as the digital circuitry power supply source.	Position B
LK2	This link controls whether the serial interface of the AD5932 is driven from a PC or used in standalone mode. Position A connects the FSYNC, SCLK, and SDATA pins to the USB controller (controlled from the software). Position B connects the FSYNC, SCLK, and SDATA pins to their respective SMBs (J3, J4, and J5).	Position A
LK3	This link selects the MCLK source. Position A selects SMB J13 (labeled MCLK). Position B selects the on-board oscillator (50 MHz provided).	Position B
LK4	This link selects whether the CTRL signal is being driven by software or externally through an SMB. Position A connects the CTRL pin to SMB J6 (labeled CTRL). Position B connects the CTRL pin to the USB controller for software control.	Position B
LK5	This link selects whether the INTERRUPT signal is being driven by software or externally through an SMB. Position A connects the INTERRUPT pin to SMB J7 (labeled INTERRUPT). Position B connects the INTERRUPT pin to the USB controller for software control.	Position B
LK6	This link selects whether the STANDBY signal is being driven by software or externally through an SMB. Position A connects the STANDBY pin to the STANDBY SMB J8 (labeled STANDBY). Position B connects the STANDBY pin to the USB controller for software control.	Position B
LK7	Insert this link to connect the CAP/2.5 V pin to DVDD if operating DVDD at <2.5 V.	Removed
LK8	This link selects the power supply source for the analog circuitry (AVDD). Position A selects J14 as the analog circuitry supply source. Position B connects AVDD to DVDD through a ferrite bead, L1 (600 Ω at 100 MHz) and a 1.6 Ω resistor (R16).	Position B

EVALUATION BOARD SOFTWARE

The AD5932 evaluation kit is available from the Analog Devices website at www.analog.com. The AD5932 evaluation software is included in the evaluation kit on a CD, and is also available for download at the [EVAL-AD5932EBZ](#) product page.

Install the evaluation software before connecting the evaluation board to the USB port of the PC to ensure that the evaluation board is correctly recognized when connected to the PC.

The evaluation software is compatible with Windows® XP (32-bit), Windows Vista, and Windows 7 (32-bit and 64-bit).

INSTALLING THE SOFTWARE

To install the evaluation software, take the following steps:

1. From the [EVAL-AD5932EBZ](#) product page, download the AD5932 evaluation software .zip file. The evaluation software is also included in the AD5932 evaluation kit on a CD.
2. Open the folder and double-click the **setup.exe** file to start the installation procedure.
3. When prompted, select the destination directory for the AD5932 program and the National Instruments products. By default, the files are saved to **C:\Program Files\Analog Devices\AD5932**.
4. When the directory has been selected, the installation procedure copies the files into the relevant directories on the hard drive. The installation program creates a program group named **Analog Devices** with the subgroup **AD5932** in the **Start** menu of the taskbar.
5. Double-click the **AD5932** icon to start the program. The evaluation board is then automatically detected.

USING THE SOFTWARE

To launch the software, click **Start > All Programs > Analog Devices > AD5932 > AD5932 Evaluation Software**. The AD5932 evaluation software is launched as a LabView GUI (see Figure 2).



Figure 2. LabView GUI for AD5932

The upper half of the window provides the different control register options for determining the output and operation mode of the device. More details on all of these options can be found in the [AD5932](#) data sheet.

After completing the control register write section, enter the frequency of MCLK in Hertz (Hz). This value is then used to calculate all frequency and time values throughout the software.

Next, enter the values for the numeric registers: the start frequency (f_{START}), frequency increments (Δf), and number of increments (N_{INCR}).

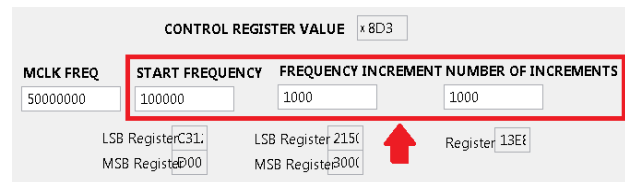

Figure 3. Frequency Output

The values of the start frequency and the increment frequency are entered in Hertz (Hz).

The increment frequency determines the duration of the DAC output signal for each individual frequency of the frequency scan. The AD5932 offers the user two choices:

- The duration is a multiple of cycles of the output frequency (f_{OUT})
- The duration is a multiple of MCLK cycles (MCLK)

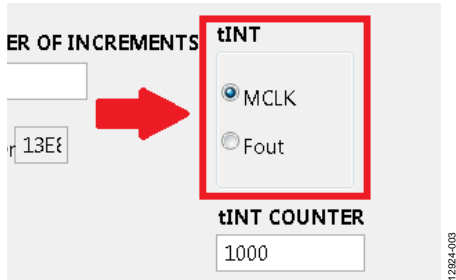

Figure 4. DAC Output Determination Options

The SYNCSEL and MSB outputs are also available from the EVAL-AD5932EBZ evaluation board. The user can select whether to create a pulse at the end of sweep (EOS) or at the end of each frequency increment using the SYNCSEL FUNCTION, as shown in Figure 5.

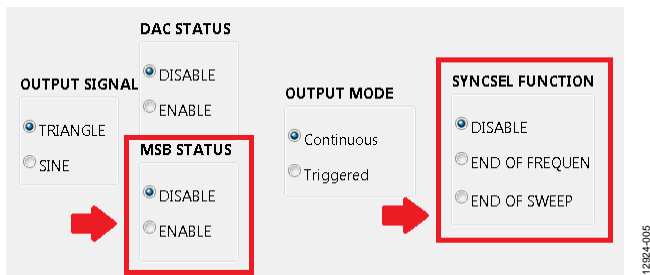

Figure 5. Pin Configuration

Finally, the PROGRAM button (see Figure 6) writes this information to the AD5932 registers. To start the frequency sweep, click CONTROL. The STANDBY pin allows sections of the AD5932 that are not in use to be powered down to minimize power consumption. The INTERRUPT pin allows the user to interrupt during a frequency scan.

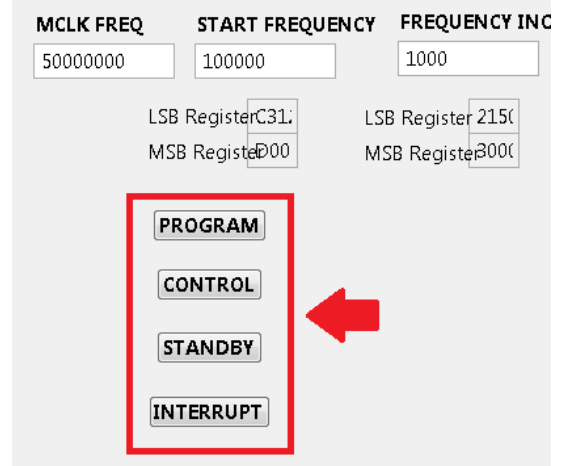

Figure 6. Control Pins

EVALUATION BOARD SCHEMATICS AND ARTWORK

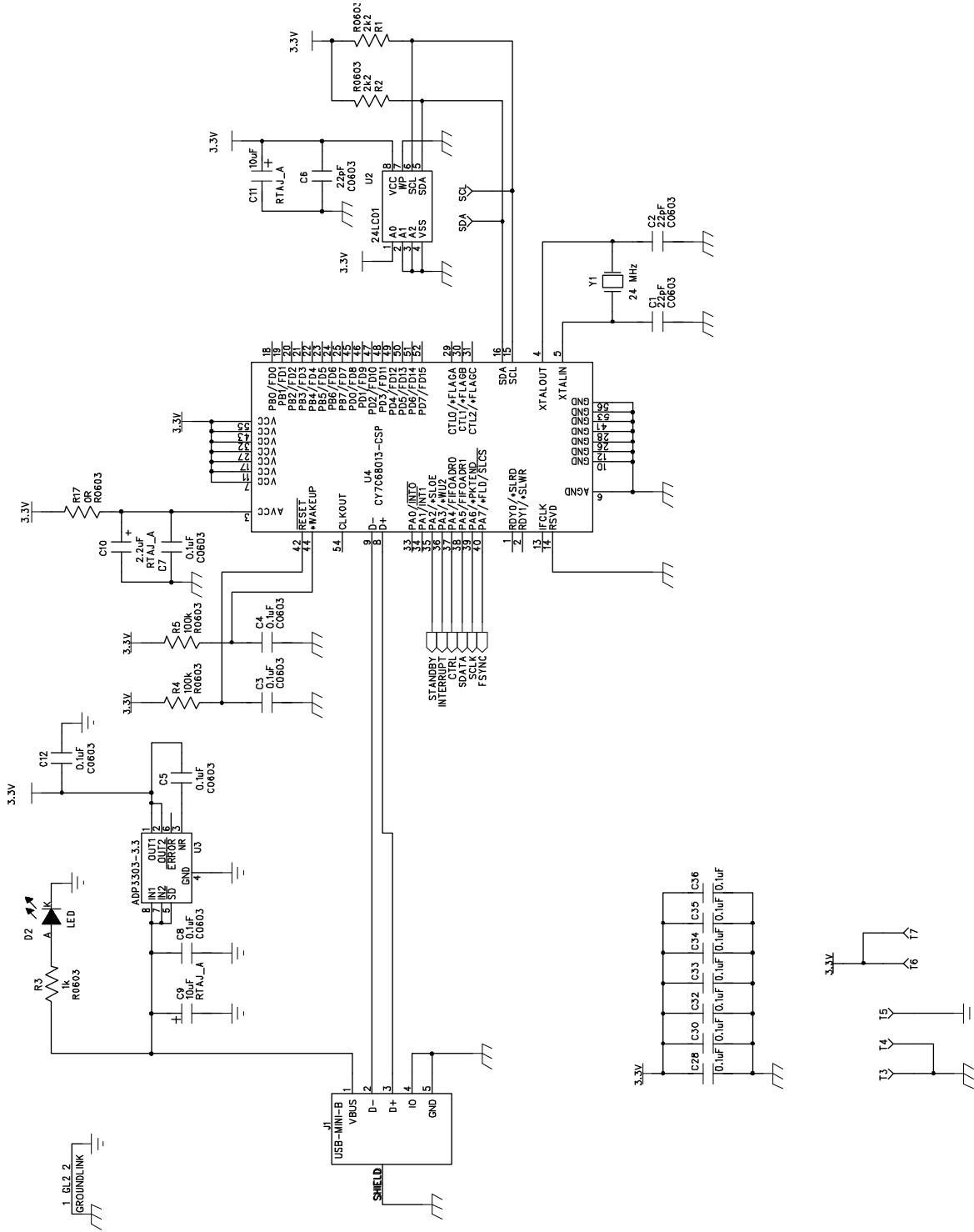

Figure 7. EVAL-AD5932EBZ Schematic, Page 1 of 2

12924-007

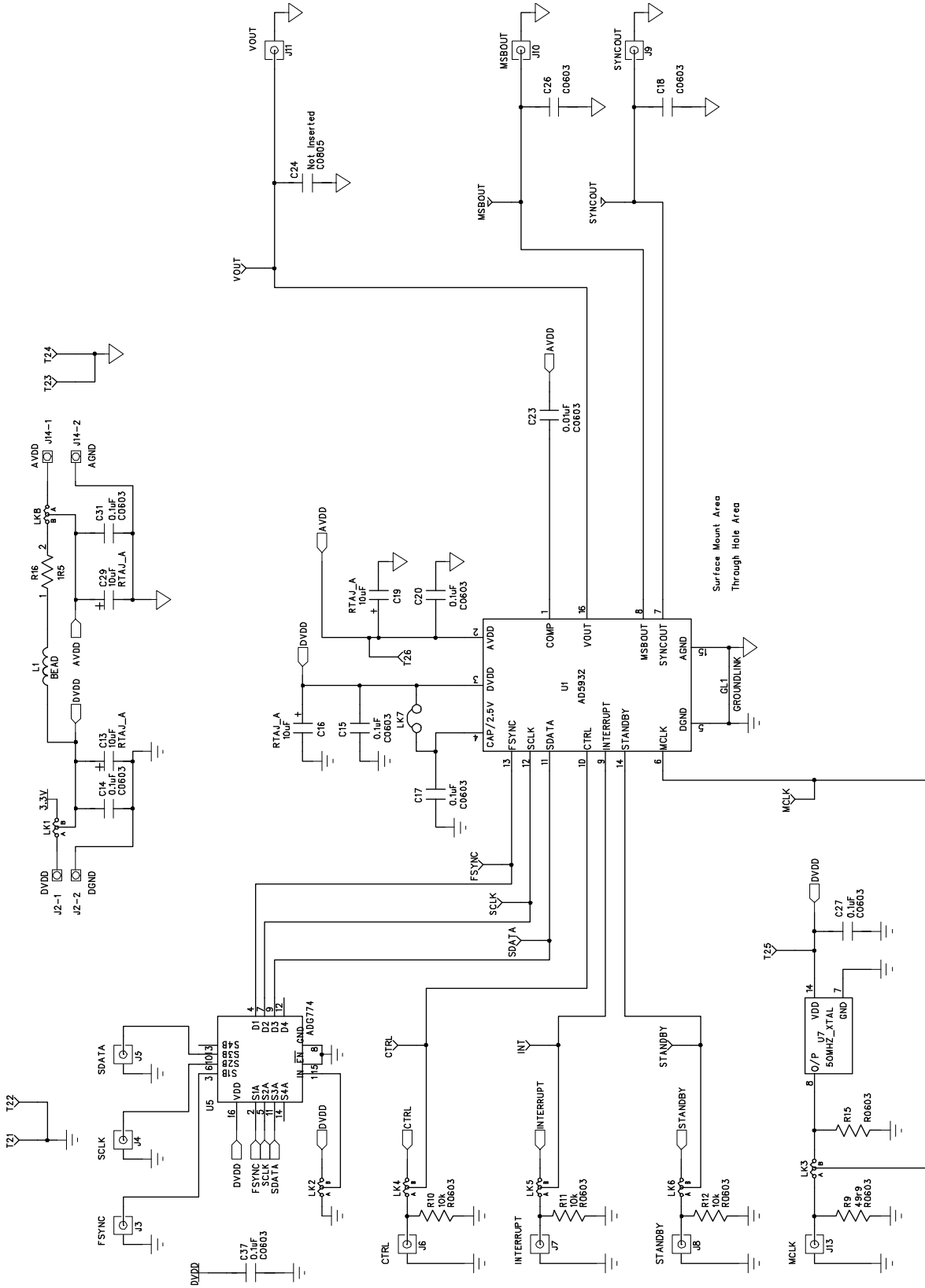

Figure 8. EVAL-AD5932EBZ Schematic, Page 2 of 2

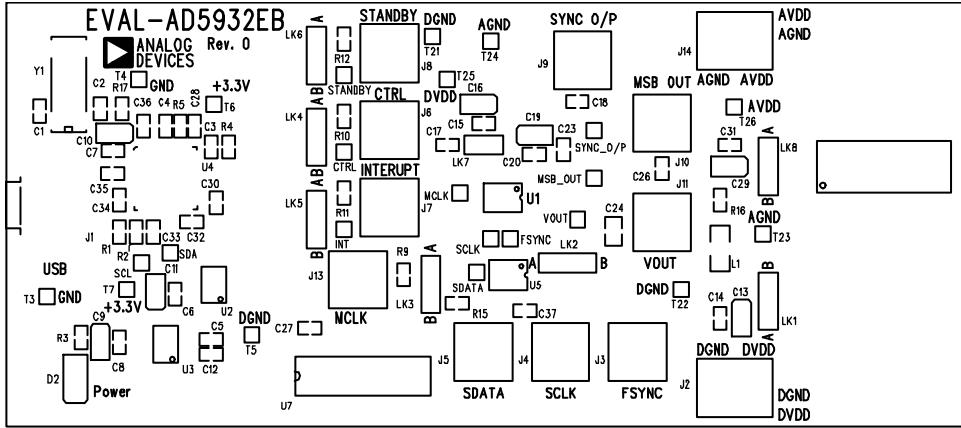

Figure 9. EVAL-AD5932EBZ Silkscreen Artwork

12924-009

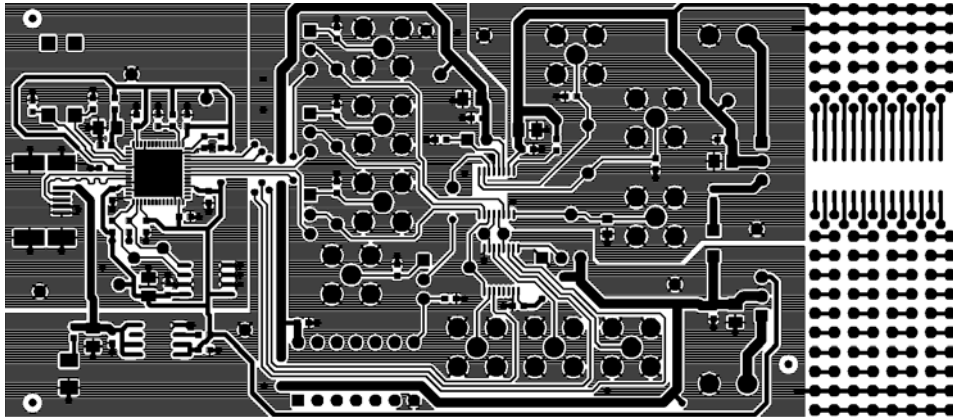

Figure 10. EVAL-AD5932EBZ Component Side Artwork

12924-010

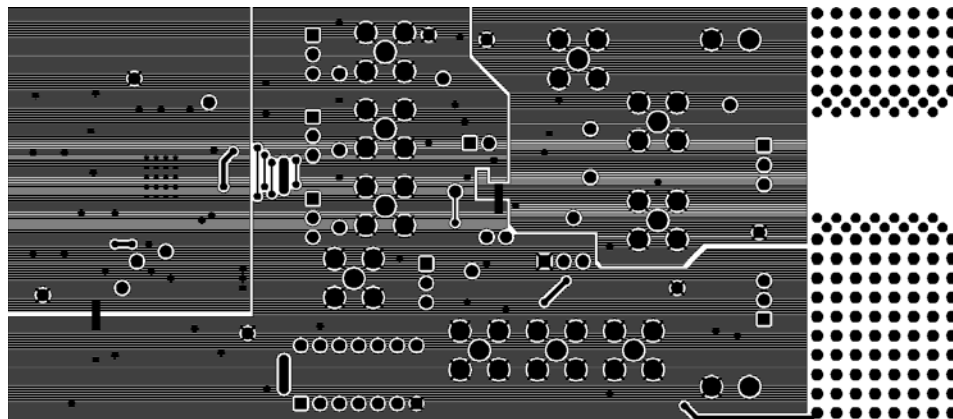

Figure 11. EVAL-AD5932EBZ Solder Side Artwork

12924-011

ORDERING INFORMATION

BILL OF MATERIALS

Table 2.

Item	Qty	Reference	Description	Supplier/Part No.
1	3	C1, C2, C6	22 pF, 0603 ceramic capacitor	FEC 722-005
2	1	C10	2.2 μF, 0805 ceramic capacitor	Digikey 445-1588-1-ND
3	2	C18, C26	0603 capacitor	Not Inserted
4	1	C24	0805 capacitor	Not Inserted
5	1	C23	0.01 μF, 0603, ceramic capacitor	FEC 722-066
6	20	C3 to C5, C7, C8, C12, C14, C15, C17, C20, C27, C28, C30 to C37	0.1 μF, 0603, ceramic capacitor	FEC 499-675
7	6	C9, C11, C13, C16, C19, C29	10 μF, TAJA, tantalum capacitor	FEC 331-3888
8	1	D2	Green LED	FEC 515-620
9	1	J1	USB mini-B connector (USB-OTG)	FEC 476-8309
10	2	J2, J14	2-pin terminal block (5 mm pitch)	FEC 151-785
11	10	J3 to J11, J13	Subminiature BNC connector (SMB)	FEC 310-682
12	1	L1	Ferrite bead (600 Ω at 100 MHz)	FEC 581-094
13	7	LK1 to LK6, LK8	3-pin SIL header (with shorting block)	FEC 512-047 and 150-411
14	1	LK7	2-pin SIL header (with shorting block)	FEC 511-705 and 150-411
15	2	R1, R2	2.2 kΩ, 0603 resistor	FEC 911-276
16	3	R10 to R12	10 kΩ, 0603 resistor	FEC 911-355
17	1	R15	0603, resistor	Not Inserted
18	1	R16	1.5 Ω, 0603 resistor	FEC 758-267
19	1	R17	0 Ω short	FEC 772-227
20	1	R3	1 kΩ, 0603 resistor	FEC 911-239
21	2	R4, R5	100 kΩ, 0603 resistor	FEC 911-471
22	1	R9	50 Ω, 0603 resistor	FEC 422-1825
23	26	T1 to T26	Test point	FEC 240-333
24	1	U1	AD5932	AD5932
25	1	U2	IC, serial EEPROM, 64k, 2.5 V, 8-SOIC	Digikey 24LC64-I/SN-ND
26	1	U3	Precision voltage regulator	ADP3303AR-3.3
27	1	U4	CY7C68013-CSP USB microcontroller	Embassy CY7C68013-56LFC
28	1	U5	Quad SPDT switch/2:1 mux	ADG774BRQ
29	1	U7	50 MHz, CMOS/TTL, crystal (and 14-pin DIP)	FEC 788-480/97103
30	1	Y1	24 MHz, CM309S, SMD, crystal	FEC 569-872

NOTES

**ESD Caution**

ESD (electrostatic discharge) sensitive device. Charged devices and circuit boards can discharge without detection. Although this product features patented or proprietary protection circuitry, damage may occur on devices subjected to high energy ESD. Therefore, proper ESD precautions should be taken to avoid performance degradation or loss of functionality.

Legal Terms and Conditions

By using the evaluation board discussed herein (together with any tools, components documentation or support materials, the "Evaluation Board"), you are agreeing to be bound by the terms and conditions set forth below ("Agreement") unless you have purchased the Evaluation Board, in which case the Analog Devices Standard Terms and Conditions of Sale shall govern. Do not use the Evaluation Board until you have read and agreed to the Agreement. Your use of the Evaluation Board shall signify your acceptance of the Agreement. This Agreement is made by and between you ("Customer") and Analog Devices, Inc. ("ADI"), with its principal place of business at One Technology Way, Norwood, MA 02062, USA. Subject to the terms and conditions of the Agreement, ADI hereby grants to Customer a free, limited, personal, temporary, non-exclusive, non-sublicensable, non-transferable license to use the Evaluation Board FOR EVALUATION PURPOSES ONLY. Customer understands and agrees that the Evaluation Board is provided for the sole and exclusive purpose referenced above, and agrees not to use the Evaluation Board for any other purpose. Furthermore, the license granted is expressly made subject to the following additional limitations: Customer shall not (i) rent, lease, display, sell, transfer, assign, sublicense, or distribute the Evaluation Board; and (ii) permit any Third Party to access the Evaluation Board. As used herein, the term "Third Party" includes any entity other than ADI, Customer, their employees, affiliates and in-house consultants. The Evaluation Board is NOT sold to Customer; all rights not expressly granted herein, including ownership of the Evaluation Board, are reserved by ADI. CONFIDENTIALITY. This Agreement and the Evaluation Board shall all be considered the confidential and proprietary information of ADI. Customer may not disclose or transfer any portion of the Evaluation Board to any other party for any reason. Upon discontinuation of use of the Evaluation Board or termination of this Agreement, Customer agrees to promptly return the Evaluation Board to ADI. ADDITIONAL RESTRICTIONS. Customer may not disassemble, decompile or reverse engineer chips on the Evaluation Board. Customer shall inform ADI of any occurred damages or any modifications or alterations it makes to the Evaluation Board, including but not limited to soldering or any other activity that affects the material content of the Evaluation Board. Modifications to the Evaluation Board must comply with applicable law, including but not limited to the RoHS Directive. TERMINATION. ADI may terminate this Agreement at any time upon giving written notice to Customer. Customer agrees to return to ADI the Evaluation Board at that time. LIMITATION OF LIABILITY. THE EVALUATION BOARD PROVIDED HEREUNDER IS PROVIDED "AS IS" AND ADI MAKES NO WARRANTIES OR REPRESENTATIONS OF ANY KIND WITH RESPECT TO IT. ADI SPECIFICALLY DISCLAIMS ANY REPRESENTATIONS, ENDORSEMENTS, GUARANTEES, OR WARRANTIES, EXPRESS OR IMPLIED, RELATED TO THE EVALUATION BOARD INCLUDING, BUT NOT LIMITED TO, THE IMPLIED WARRANTY OF MERCHANTABILITY, TITLE, FITNESS FOR A PARTICULAR PURPOSE OR NON-INFRINGEMENT OF INTELLECTUAL PROPERTY RIGHTS. IN NO EVENT WILL ADI AND ITS LICENSORS BE LIABLE FOR ANY INCIDENTAL, SPECIAL, INDIRECT, OR CONSEQUENTIAL DAMAGES RESULTING FROM CUSTOMER'S POSSESSION OR USE OF THE EVALUATION BOARD, INCLUDING BUT NOT LIMITED TO LOST PROFITS, DELAY COSTS, LABOR COSTS OR LOSS OF GOODWILL. ADI'S TOTAL LIABILITY FROM ANY AND ALL CAUSES SHALL BE LIMITED TO THE AMOUNT OF ONE HUNDRED US DOLLARS (\$100.00). EXPORT. Customer agrees that it will not directly or indirectly export the Evaluation Board to another country, and that it will comply with all applicable United States federal laws and regulations relating to exports. GOVERNING LAW. This Agreement shall be governed by and construed in accordance with the substantive laws of the Commonwealth of Massachusetts (excluding conflict of law rules). Any legal action regarding this Agreement will be heard in the state or federal courts having jurisdiction in Suffolk County, Massachusetts, and Customer hereby submits to the personal jurisdiction and venue of such courts. The United Nations Convention on Contracts for the International Sale of Goods shall not apply to this Agreement and is expressly disclaimed.