

Evaluation Board for the **AD5679R** 16-Bit, 16-Channel, Voltage Output DAC

FEATURES

Full featured evaluation board for the **AD5679R**
 Various link options
 PC control in conjunction with the Analog Devices, Inc., SDP board

EVALUATION KIT CONTENTS

EVAL-AD5679RSDZ
 USB cable

HARDWARE REQUIRED

EVAL-SDP-CB1Z (SDP-B) board, must be purchased separately

SOFTWARE REQUIRED

Analysis | Control | Evaluation software, available for download from the EVAL-AD5679RSDZ product page

GENERAL DESCRIPTION

This user guide details the operation of the EVAL-AD5679RSDZ for the **AD5679R** 16-bit, 16-channel, voltage output, digital-to-analog converter (DAC).

The EVAL-AD5679RSDZ allows users to quickly prototype **AD5679R** circuits and reduce design time. The **AD5679R**

operates from a single 2.7 V to 5.5 V supply range. The **AD5679R** incorporates an internal 2.5 V reference to give an output voltage of 2.5 V or 5 V. The EVAL-AD5679RSDZ also incorporates additional voltage references.

The EVAL-AD5679RSDZ interfaces to the USB port of a PC via a system demonstration platform (**SDP-B**) board. The Analysis | Control | Evaluation (**ACE**) software is available for download from the EVAL-AD5679RSDZ product page to use with the evaluation board to allow the user to program the **AD5679R**. A peripheral module interface (PMOD) connection is also available to allow the connection of microcontrollers to the evaluation board without the **SDP-B** board. When a microcontroller is used through the PMOD connection, the **SDP-B** board must be disconnected, and the user is unable to operate the **ACE** software.

The EVAL-AD5679RSDZ is compatible with any Analog Devices, Inc., **SDP-B** board, which can be purchased separately. A typical connection between the EVAL-AD5679RSDZ and the **SDP-B** controller board is shown in Figure 1.

For full details, see the **AD5679R** data sheet, which must be used in conjunction with this user guide when using the EVAL-AD5679RSDZ.

EVALUATION BOARD PHOTOGRAPH

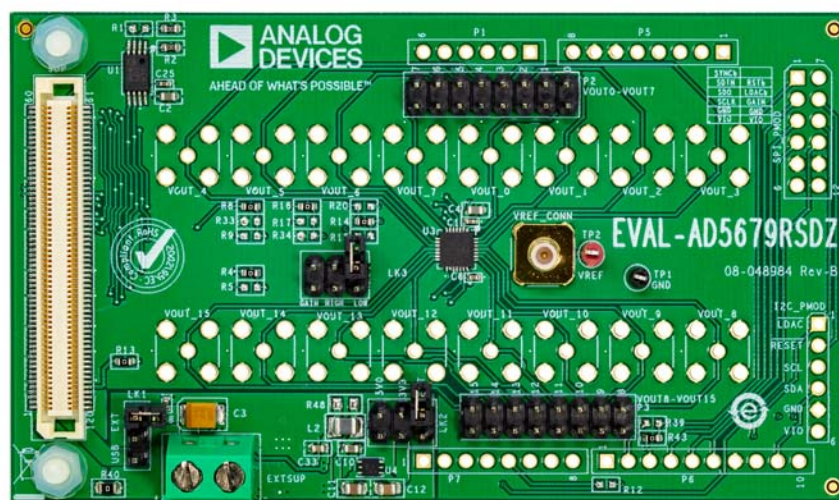

Figure 1. EVAL-AD5679RSDZ

TABLE OF CONTENTS

Features	1	Functional Block Diagram and Description.....	4
Evaluation Kit Contents.....	1	Memory Map	5
Hardware Required	1	Evaluation Board Hardware.....	6
Software Required	1	Power Supplies.....	6
General Description	1	Link Options	6
Evaluation Board Photograph.....	1	On-Board Connectors	6
Revision History	2	Evaluation Board Schematics and Artwork.....	7
Evaluation Board Software Quick Start Procedures	3	Ordering Information.....	12
Installing the Software	3	Bill of Materials.....	12
Initial Setup	3		

REVISION HISTORY

8/2019—Revision 0: Initial Version

EVALUATION BOARD SOFTWARE QUICK START PROCEDURES

INSTALLING THE SOFTWARE

The EVAL-AD5679RSDZ uses the ACE evaluation software, which allows the evaluation and control of multiple evaluation systems.

The ACE installer installs the necessary SDP-B drivers and the Microsoft® .NET Framework 4 by default. The ACE software is available for download from the EVAL-AD5679RSDZ product page and must be installed before connecting the SDP-B board to the USB port of the PC to ensure that the SDP-B board is recognized connected to the PC. For full instructions on how to install and use this software, see the ACE software page on the Analog Devices website.

After the installation is finished, the EVAL-AD5679RSDZ plug-in appears when the ACE software is opened.

INITIAL SETUP

To set up the evaluation board, take the following steps:

1. Connect the evaluation board to the SDP-B board, and then connect the USB cable between the SDP-B board and the PC.
2. Run the ACE application. The EVAL-AD5679RSDZ plug-ins appear in the attached hardware section of the Start tab.
3. Double-click the board plug-in to open the board view seen in Figure 2.
4. Double-click the AD5679R chip to access the chip block diagram. This view provides a basic representation of the functionality of the board. The main functions of the board are labeled in Figure 3.

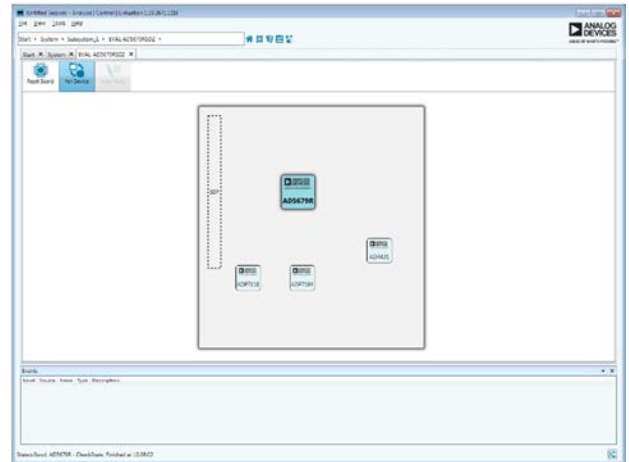

Figure 2. Board View of the EVAL-AD5679RSDZ

17275-002

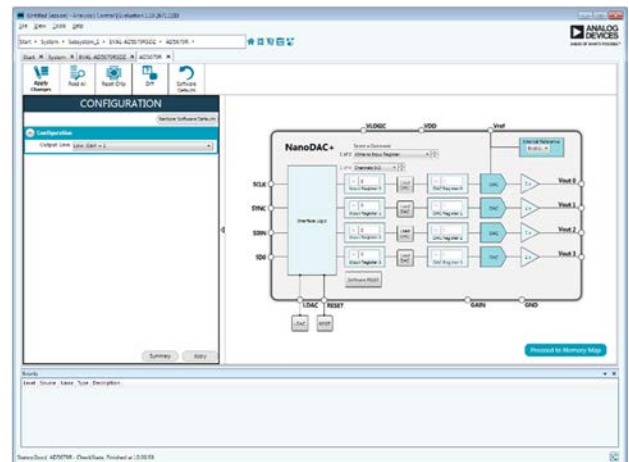

Figure 3. Chip Block Diagram of the AD5679R

17275-003

FUNCTIONAL BLOCK DIAGRAM AND DESCRIPTION

The EVAL-AD5679RSDZ software is organized to appear similarly to the functional block diagram shown in the [AD5679R](#) data sheet, which simplifies correlating the functions on the EVAL-AD5679RSDZ with the description in the [AD5679R](#) data sheet.

For a full description of each block, register, and its settings, see the [AD5679R](#) data sheet.

Some of the blocks and their functions are described in this section as they pertain to the evaluation board. The full screen block diagram is shown in Figure 4. Table 1 describes the functionality of each block.

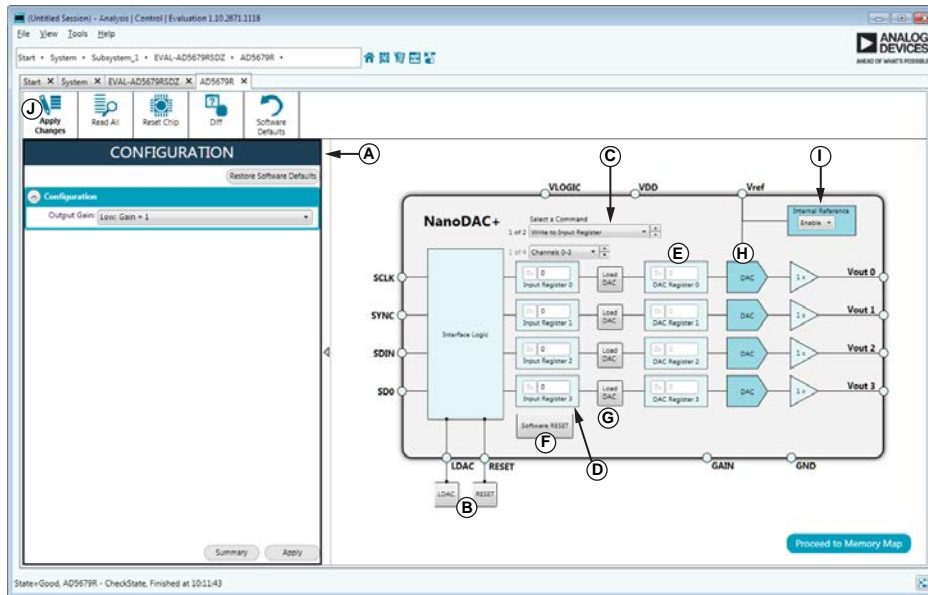

Figure 4. AD5679R Block Diagram with Labels

Table 1. Block Diagram Functions (See Figure 4)

Label	Button/Function Name	Function
A	CONFIGURATION wizard	Used to set the initial configuration for the board. Select the reference gain case from the Output Gain dropdown menu. A gain of 1 is the default. After setting up the initial configuration, click Apply to apply the values. These settings can be modified at any stage while evaluating the board.
B	LDAC and RESET (GPIO buttons)	Act as external GPIO pulses to the LDAC pin and RESET pin. The LDAC button pushes data from both input registers (Label D) to the DAC registers (Label E). The RESET button clears all data from input registers and DAC registers. These buttons are live and there is no need to click Apply Changes (Label J).
C	Select a Command	Command option dropdown menu selects how the data being transferred to the device affects the input registers and DAC registers. After a data value is entered in an input register (Label D), this menu determines if the data is transferred to the input register only, or to the channel input register (Label D) and the channel DAC register (Label E).
D	Input Register 0 through Input Register 3	16-bit data word to be transferred to the device. Click Apply Changes (Label J) to transfer this 16-bit data word to the device.
E	DAC Register 0 through DAC Register 3	Displays the value that is currently present in the DAC register on the device. Update the DAC registers by selecting the appropriate command option or by toggling LDAC (Label B).
F	Software RESET	Returns the evaluation board and software to default values. This button is live. Therefore, there is no need to click Apply Changes .
G	Load DAC	Users can individually control which channel loads the values from the input registers to the DAC register.
H	DAC	DAC configuration options provide access to individual channel configuration options such as power-down options and hardware LDAC mask enable and disable settings.
I	Internal Reference	Select Enable from this setting to enable the on-chip reference for the evaluation board. If Disable is selected, an external reference must be applied. This control is only available on the AD5679R .
J	Apply Changes	Applies all modified values to the device. Note that if an evaluation board is not connected, values entered in the input registers are not transferred to the DAC registers.

MEMORY MAP

All registers are fully accessible from the **AD5679R Memory Map** tab, shown in Figure 5. This tab allows registers to be edited at bit level. The bits shaded in dark gray are read-only bits and cannot be accessed from the **ACE** software. All other bits are toggled.

Clicking the **Apply Changes** button transfers data to the device. All changes made in the memory map tab correspond to the block diagram. For example, if the internal register bit is enabled, it displays as enabled on the block diagram. Any bits or registers that are shown in bold in the memory map tab are modified values that have not been transferred to the evaluation board (see Figure 6). Click **Apply Changes** to transfer the data to the evaluation board.

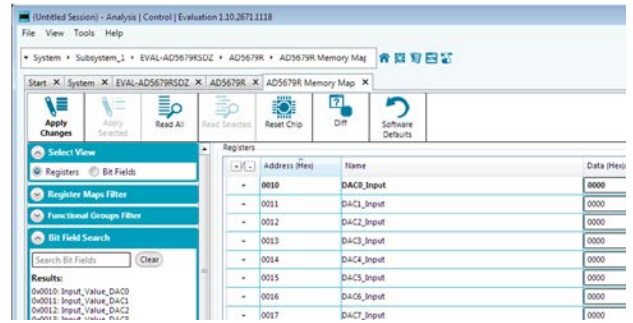

Figure 5. AD5679R Memory Map Tab



Figure 6. AD5679R Memory Map with Unapplied Changes in the DAC0_Input Register

EVALUATION BOARD HARDWARE

POWER SUPPLIES

The EVAL-AD5679RSDZ provides on-board 3.3 V and 5 V regulators powered through the USB supply or from an external source. If a different supply is required or if the evaluation board is controlled through the PMOD connector, an external supply must be provided by the external supply voltage (EXTSUP) connector. See Table 2 for more details.

Every supply is decoupled to ground with 10 μ F tantalum and 0.1 μ F ceramic capacitors.

Table 2. Power Supply Connectors

Connector Label	External Voltage Supplies Description
EXTSUP, Pin 1	External analog power supply from 2.7 V to 5.5 V.
EXTSUP, Pin 2	Analog ground.
VREF_CONN	External voltage reference.

Table 3. Link Functions

Link	Description
LK1	This link selects the primary analog voltage source for the 3.3 V output and 5 V output for LK2. There are two options, as follows: The USB option selects the USB supply from Pin 5 of the 120-pin connector of the SDP-B board. The EXT option selects an EXTSUP connector. Voltage applied to EXTSUP must be between 2.7 V to 5.5 V.
LK2	This link selects the DAC analog voltage source. There are three options, as follows: The 5V0 option selects the on-board 5 V source from the LTC3536 . The 3V3 option selects the on-board 3.3 V source from the ADM7160 . The EXT option selects an EXTSUP connector. Voltage applied to EXTSUP must be between 2.7 V to 5.5 V.
LK3	This link selects the gain setting for the DAC. There are three options, as follows: The gain option allows the ACE plugin to control the gain setting of the device. The high option selects gain = 2. The low option selects gain = 1.

ON-BOARD CONNECTORS

Table 4 shows the connectors on EVAL-AD5679RSDZ.

Table 4. On-Board Connectors

Connector	Function
EXTSUP	External analog power supply from 2.7 V to 5.5 V.
VREF_CONN	External voltage reference.
P2	DAC outputs from V_{OUT0} to V_{OUT7} .
P3	DAC outputs from V_{OUT8} to V_{OUT15} .

EVALUATION BOARD SCHEMATICS AND ARTWORK

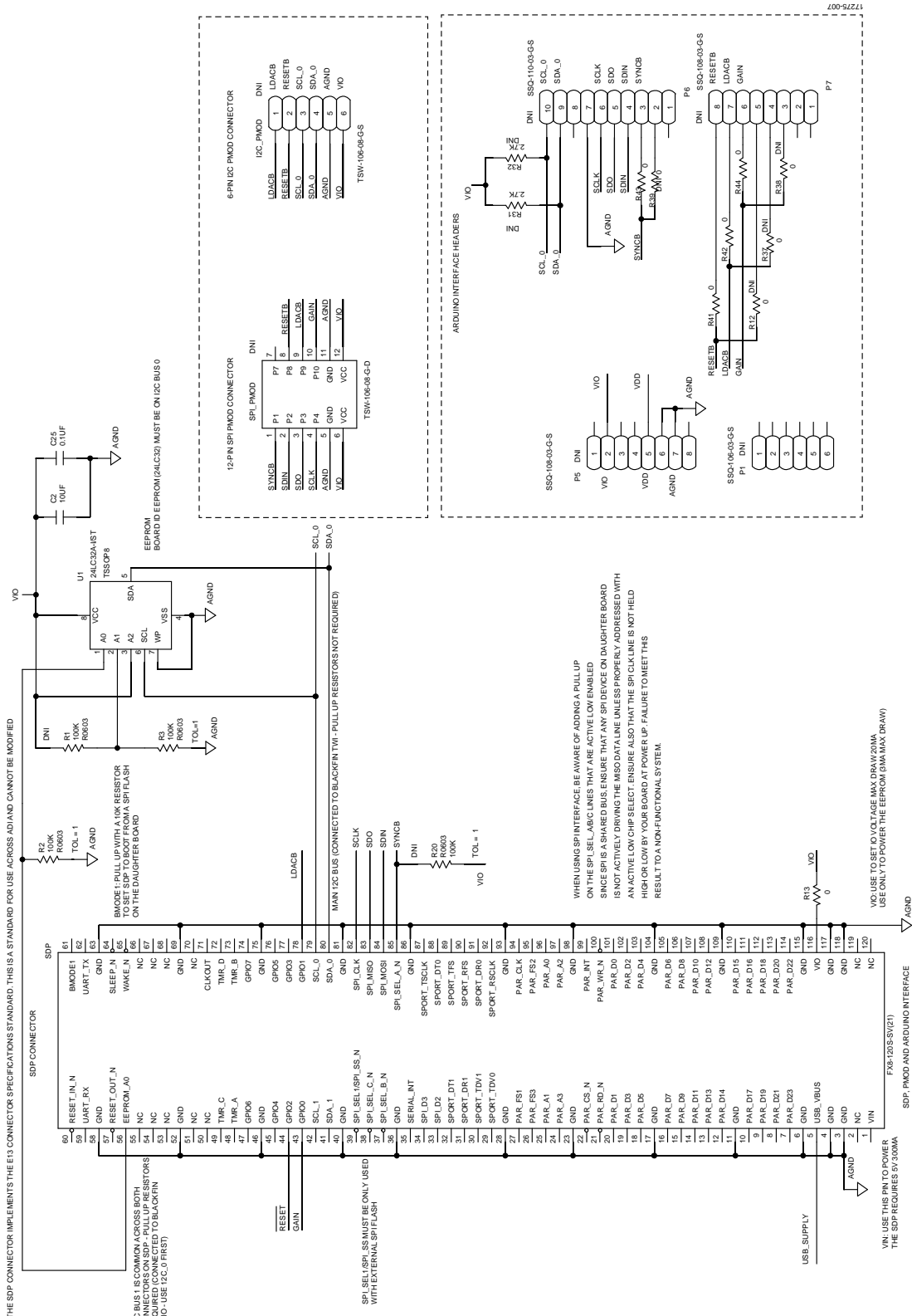

Figure 7. EVAL-AD5679RSDZ Schematic, SDP, Arduino®-Compatible, PMOD Connectors

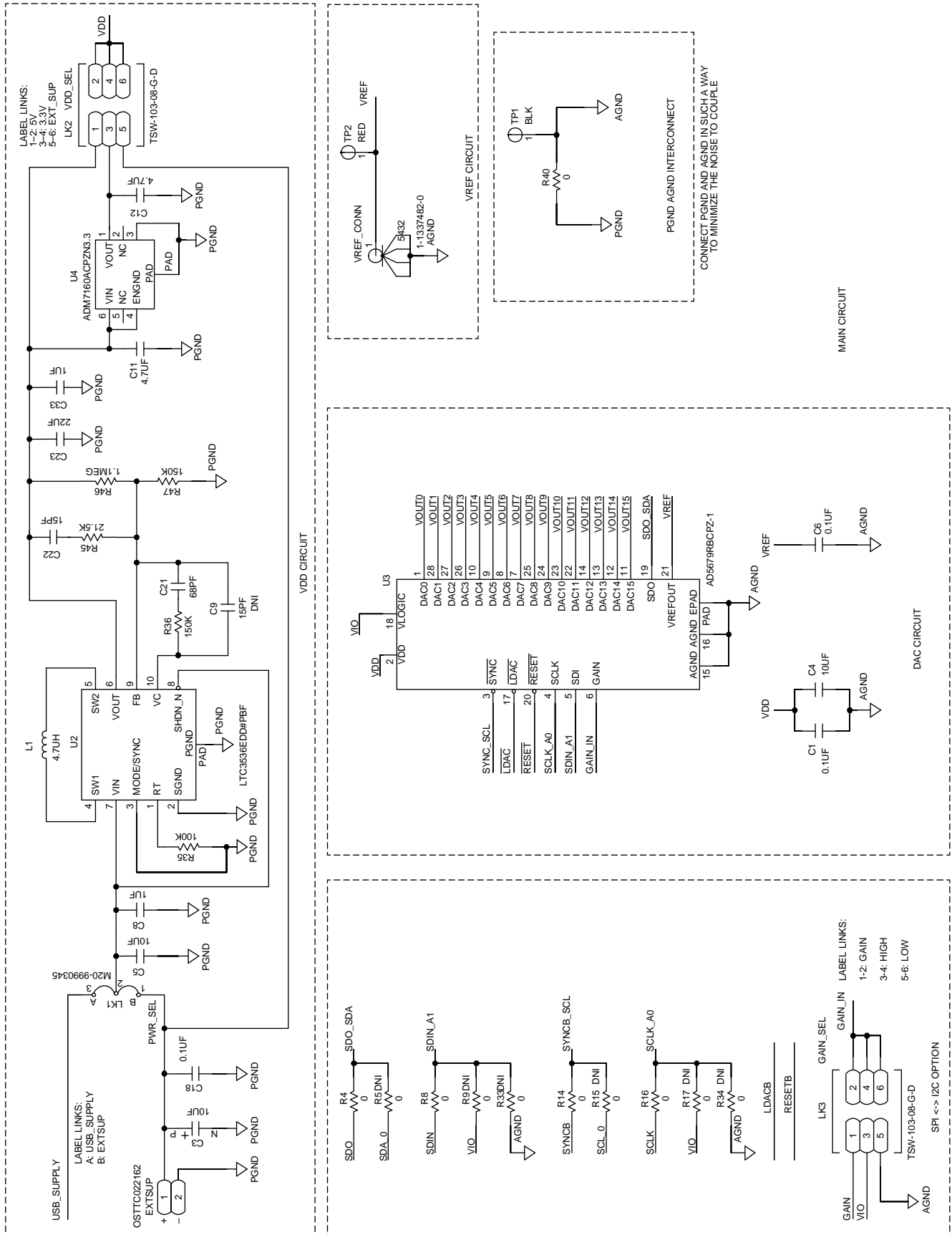

Figure 8. EVAL-AD5679RSDZ Schematic, Main Circuit
Rev. 0 | Page 8 of 13

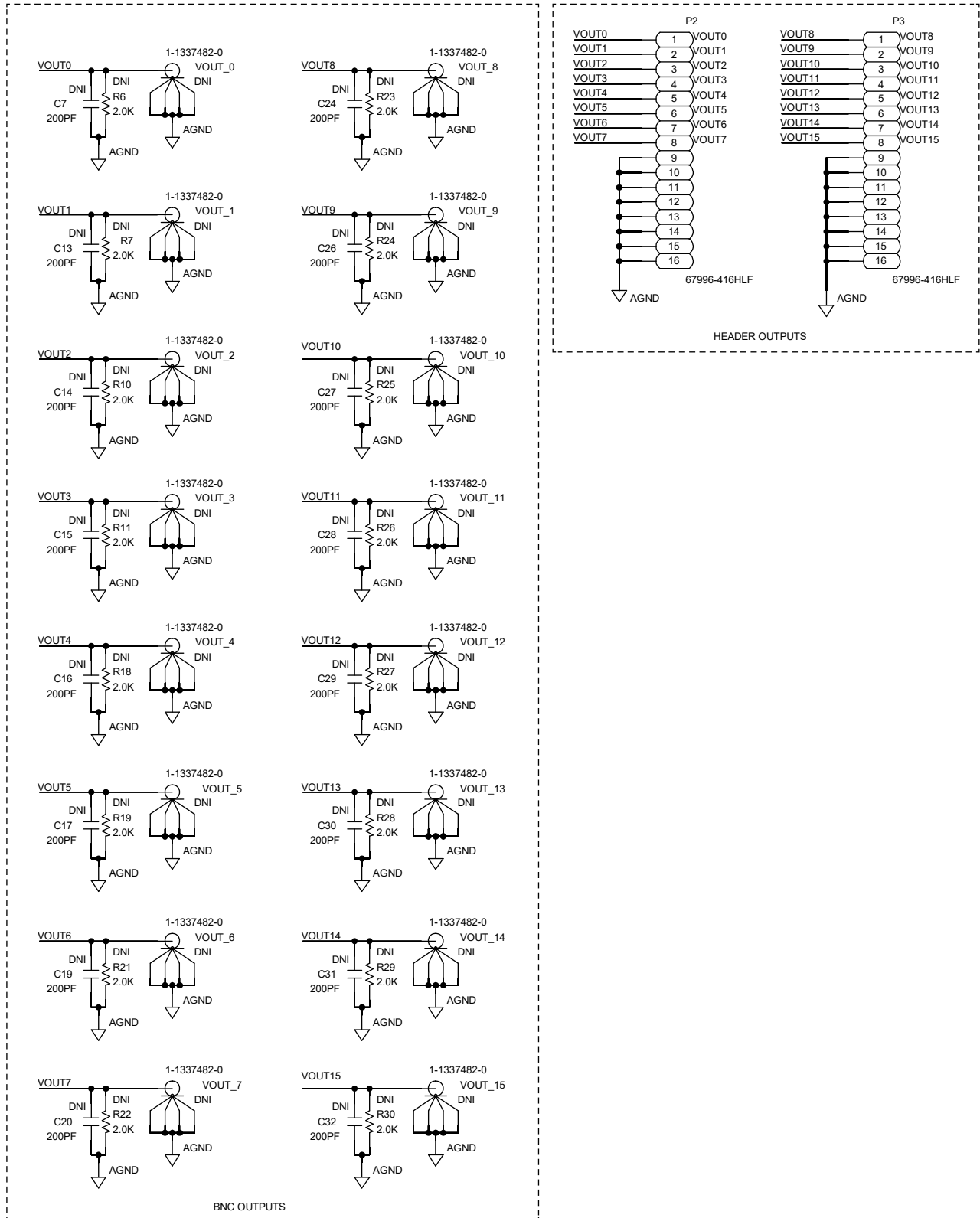

Figure 9. EVAL-AD5679RSDZ Schematic, Output Connectors

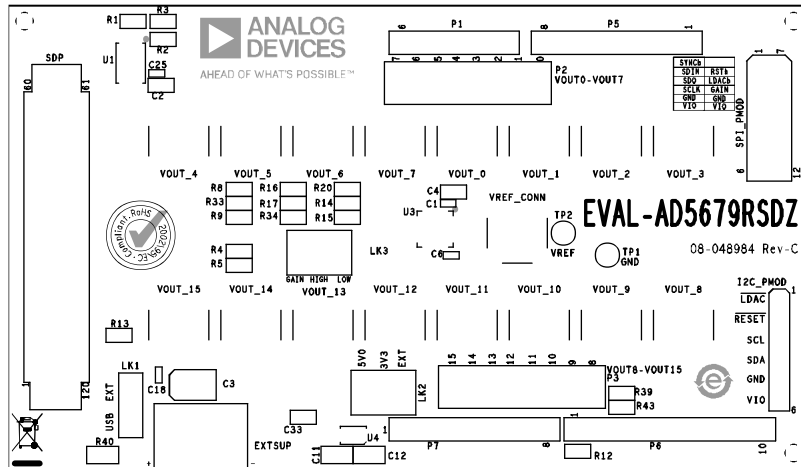

Figure 10. EVAL-AD5679RSDZ Top Side Component Placement

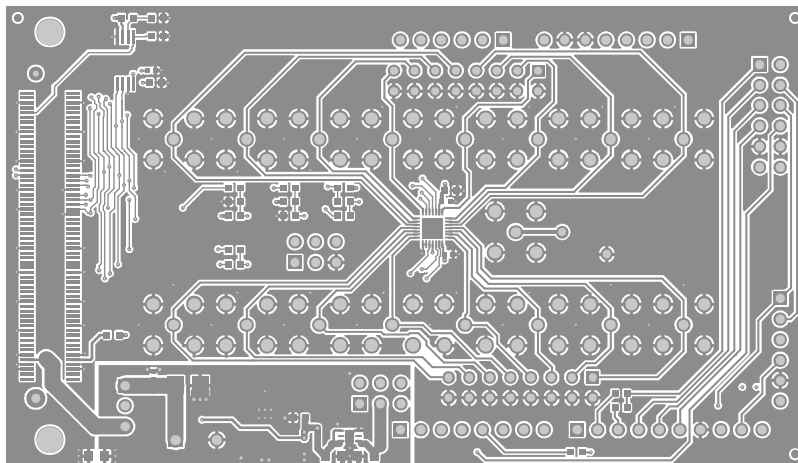

Figure 11. EVAL-AD5679RSDZ Top Side Routing

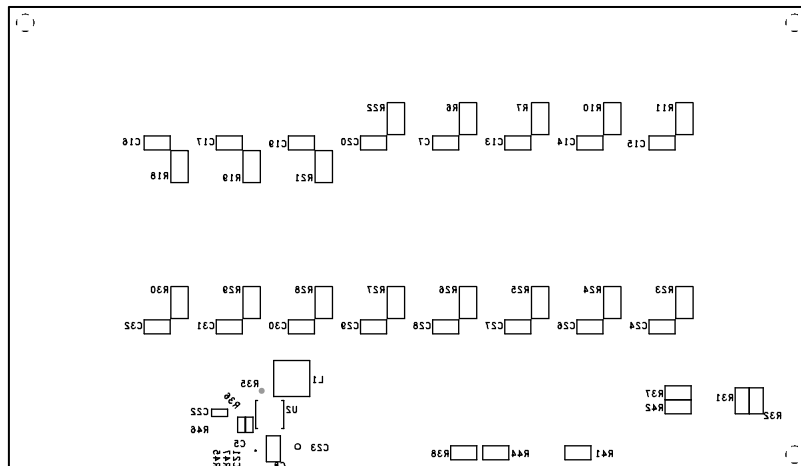

Figure 12. EVAL-AD5679RSDZ Bottom Side Component Placement

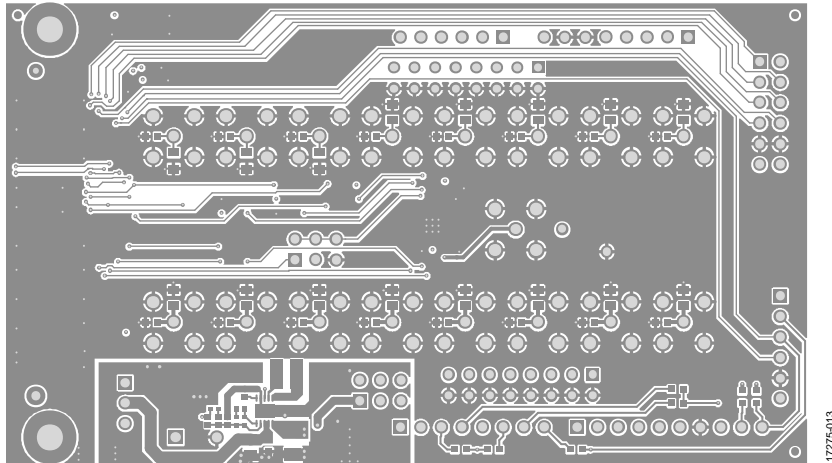

Figure 13. EVAL-AD5679RSDZ Bottom Side Routing

ORDERING INFORMATION

BILL OF MATERIALS

Table 5.

Qty	Reference Designator	Description	Supplier/Part Number ^{1, 2}
4	C1, C6, C18, C25	Ceramic capacitors, 0.1 μ F, 16 V, X7R, 0402	GRM155R71C104KA88D
2	C11, C12	Ceramic capacitors, 4.7 μ F, 10 V, X7R, 0805	C2012X7R1A475M085AC
2	C2, C4	Ceramic capacitors, 10 μ F, 10 V, X5R, 0603	GRM188R61A106KE69D
1	C21	Ceramic capacitor, 68 pF, 50 V, NP0, 0402	GCM1555C1H680JA16D
1	C22	Ceramic capacitor, 15 pF, 50 V, COG, 0402	CGA2B2C0G1H150J050BA
1	C23	Ceramic capacitor, 22 μ F, 25 V, X5R, 1206	CL31A226KAHNNNE
1	C3	Tantalum capacitor, 10 μ F, 16 V, 1411	TAJB106K016RNJ
2	C8, C33	Ceramic capacitors, 1 μ F, 10 V, X7R, 0603	CL10B105KP8NNNC
1	C5	Ceramic capacitor, 10 μ F, 25 V, X5R, 0805	GRM21BR61E106KA73L
1	EXTSUP	Terminal block, 5.08 mm pitch	OSTTC022162
1	L1	Inductor, 4.7 μ H, 5 A, 57.4 m Ω direct current resistance (DCR)	XFL4020-472MEB
1	LK1	3-pin male header, 2.54 mm pitch	M20-9990345
2	LK2, LK3	6-pin male headers, 2.54 mm pitch	TSW-103-08-G-D
2	P2, P3	16-pin male headers, 2.54 mm pitch	67996-416HLF
1	R13	Resistor, SMD, 0 Ω , 1%, 1/10 W, 0603, thick film	CRCW0603000ZRT1
8	R4, R8, R14, R16, R41, R42, R43, R44	Resistors, SMD, 0 Ω , 1/16 W, 0603, thick film	MC0603WG00000T5E-TC
2	R2, R3	Resistors, SMD, 100 k Ω , 5%, 1/10 W, 0603, thick film	RC0603JR-07100KL
1	R35	Resistor, SMD, 100 k Ω , 1%, 1/5 W, 0402, thick film	ERJ-PA2F1003X
2	R36, R47	Resistors, SMD, 150 k Ω , 1%, 1/10 W, 0402, thick film	ERJ-2RK1503X
1	R40	Resistor, SMD, 0 Ω , 1/10 W, 0805, thick film	MC 0.1W 0805 0R
1	R45	Resistor, SMD, 21.5 k Ω , 1%, 1/10 W, 0402, thick film	ERJ-2RK2152X
1	R46	Resistor, SMD, 1.1 M Ω , 1%, 1/16 W, 0402, thick film	AC0402FR-071M1L
1	SDP	SDP connector	FX8-120S-SV(21)
1	TP1	Test point, black	20-2137
1	TP2	Test point, red	20-313137
1	VREF_CONN	SubMiniature version B (SMB) connector	1-1337482-0
1	U1	32 k Ω , I ² C electronically erasable programmable read-only memory (EEPROM)	24LC32A-I/ST
1	U2	1 A low noise, buck-boost dc-to-dc converter	LTC3536EDD#PBF
1	U3	16-Channel, 16-Bit, <i>nano</i> DAC+	AD5679RBCPZ-1
1	U4	Ultralow noise, 200 mA linear regulator	ADM7160ACPZN3.3-R7

¹ FEC refers to Farnell Electronic Component Distributors.² Generic indicates that any device with the specified value, size, and rating can be used.

NOTES

I²C refers to a communications protocol originally developed by Philips Semiconductors (now NXP Semiconductors).



ESD Caution

ESD (electrostatic discharge) sensitive device. Charged devices and circuit boards can discharge without detection. Although this product features patented or proprietary protection circuitry, damage may occur on devices subjected to high energy ESD. Therefore, proper ESD precautions should be taken to avoid performance degradation or loss of functionality.

Legal Terms and Conditions

By using the evaluation board discussed herein (together with any tools, components documentation or support materials, the "Evaluation Board"), you are agreeing to be bound by the terms and conditions set forth below ("Agreement") unless you have purchased the Evaluation Board, in which case the Analog Devices Standard Terms and Conditions of Sale shall govern. Do not use the Evaluation Board until you have read and agreed to the Agreement. Your use of the Evaluation Board shall signify your acceptance of the Agreement. This Agreement is made by and between you ("Customer") and Analog Devices, Inc. ("ADI"), with its principal place of business at One Technology Way, Norwood, MA 02062, USA. Subject to the terms and conditions of the Agreement, ADI hereby grants to Customer a free, limited, personal, temporary, non-exclusive, non-sublicensable, non-transferable license to use the Evaluation Board FOR EVALUATION PURPOSES ONLY. Customer understands and agrees that the Evaluation Board is provided for the sole and exclusive purpose referenced above, and agrees not to use the Evaluation Board for any other purpose. Furthermore, the license granted is expressly made subject to the following additional limitations: Customer shall not (i) rent, lease, display, sell, transfer, assign, sublicense, or distribute the Evaluation Board; and (ii) permit any Third Party to access the Evaluation Board. As used herein, the term "Third Party" includes any entity other than ADI, Customer, their employees, affiliates and in-house consultants. The Evaluation Board is NOT sold to Customer; all rights not expressly granted herein, including ownership of the Evaluation Board, are reserved by ADI. CONFIDENTIALITY. This Agreement and the Evaluation Board shall all be considered the confidential and proprietary information of ADI. Customer may not disclose or transfer any portion of the Evaluation Board to any other party for any reason. Upon discontinuation of use of the Evaluation Board or termination of this Agreement, Customer agrees to promptly return the Evaluation Board to ADI. ADDITIONAL RESTRICTIONS. Customer may not disassemble, decompile or reverse engineer chips on the Evaluation Board. Customer shall inform ADI of any occurred damages or any modifications or alterations it makes to the Evaluation Board, including but not limited to soldering or any other activity that affects the material content of the Evaluation Board. Modifications to the Evaluation Board must comply with applicable law, including but not limited to the RoHS Directive. TERMINATION. ADI may terminate this Agreement at any time upon giving written notice to Customer. Customer agrees to return to ADI the Evaluation Board at that time. LIMITATION OF LIABILITY. THE EVALUATION BOARD PROVIDED HEREUNDER IS PROVIDED "AS IS" AND ADI MAKES NO WARRANTIES OR REPRESENTATIONS OF ANY KIND WITH RESPECT TO IT. ADI SPECIFICALLY DISCLAIMS ANY REPRESENTATIONS, ENDORSEMENTS, GUARANTEES, OR WARRANTIES, EXPRESS OR IMPLIED, RELATED TO THE EVALUATION BOARD INCLUDING, BUT NOT LIMITED TO, THE IMPLIED WARRANTY OF MERCHANTABILITY, TITLE, FITNESS FOR A PARTICULAR PURPOSE OR NON-INFRINGEMENT OF INTELLECTUAL PROPERTY RIGHTS. IN NO EVENT WILL ADI AND ITS LICENSORS BE LIABLE FOR ANY INCIDENTAL, SPECIAL, INDIRECT, OR CONSEQUENTIAL DAMAGES RESULTING FROM CUSTOMER'S POSSESSION OR USE OF THE EVALUATION BOARD, INCLUDING BUT NOT LIMITED TO LOST PROFITS, DELAY COSTS, LABOR COSTS OR LOSS OF GOODWILL. ADI'S TOTAL LIABILITY FROM ANY AND ALL CAUSES SHALL BE LIMITED TO THE AMOUNT OF ONE HUNDRED US DOLLARS (\$100.00). EXPORT. Customer agrees that it will not directly or indirectly export the Evaluation Board to another country, and that it will comply with all applicable United States federal laws and regulations relating to exports. GOVERNING LAW. This Agreement shall be governed by and construed in accordance with the substantive laws of the Commonwealth of Massachusetts (excluding conflict of law rules). Any legal action regarding this Agreement will be heard in the state or federal courts having jurisdiction in Suffolk County, Massachusetts, and Customer hereby submits to the personal jurisdiction and venue of such courts. The United Nations Convention on Contracts for the International Sale of Goods shall not apply to this Agreement and is expressly disclaimed.

©2019 Analog Devices, Inc. All rights reserved. Trademarks and registered trademarks are the property of their respective owners.
UG17275-0-8/19(0)



www.analog.com