

## LTC3861EUHE High Current, Dual Output Synchronous Buck Converter

### DESCRIPTION

Demonstration circuit 1822B is a dual output synchronous buck converter featuring the [LTC®3861EUHE](#). The board provides two outputs of 1.5V/25A and 1.2V/25A from an input voltage of 7V to 14V at a switching frequency of 500kHz. The power stage consists of a 6mm × 6mm DrMOS and a 13mm × 13mm iron powder type inductor. An on-board 5V LT®3470 buck regulator provides the 5V bias for the LTC3861 and the DrMOS.

The demo board uses a high density, two sided drop-in layout. The power components, excluding the bulk output and input capacitors, fit within a 1.5" × 1.2" area on the top layer. The control circuit fits in a 1.1" × 1.0" area on the bottom layer. The package style for the LTC3861EUHE is a 36-lead 5mm × 6mm QFN.

All registered trademarks and trademarks are the property of their respective owners.

The main features of the board are:

- Remote sensing for each output, where the divider is placed before a high input impedance differential amplifier.
- CLKIN and CLKOUT pins.
- Optional resistors to tie the two outputs together.
- Connector and header to tie two or more boards together for up to 12-phase operation.
- Optional footprint for an LTC4449 gate driver and discrete MOSFETs.
- Optional footprint for a dual phase Delta power block.

[Design files for this circuit board are available.](#)

### PERFORMANCE SUMMARY (T<sub>A</sub> = 25°C), no airflow

PARAMETER	CONDITION	VALUE
Minimum Input Voltage		7V
Maximum Input Voltage		14V
Output Voltage V <sub>OUT1</sub>	I <sub>OUT1</sub> = 0A to 25A, V <sub>IN</sub> = 7V to 14V	1.5V ±2%
Output Voltage V <sub>OUT2</sub>	I <sub>OUT2</sub> = 0A to 25A, V <sub>IN</sub> = 7V to 14V	1.2V ±2%
V <sub>OUT1</sub> Maximum Output Current, I <sub>OUT1</sub>	V <sub>IN</sub> = 7V to 14V, V <sub>OUT1</sub> = 1.5V	25A
V <sub>OUT2</sub> Maximum Output Current, I <sub>OUT2</sub>	V <sub>IN</sub> = 7V to 14V, V <sub>OUT2</sub> = 1.2V	25A
Nominal Switching Frequency		500kHz
Efficiency (See Figure 2 and Figure 3)	V <sub>OUT1</sub> = 1.5V, I <sub>OUT1</sub> = 25A, V <sub>IN</sub> = 12V	91.6% Typical
	V <sub>OUT2</sub> = 1.2V, I <sub>OUT2</sub> = 25A, V <sub>IN</sub> = 12V	90.7% Typical

Note: The DC1828B demo circuit and manual replaces the DC1828A. The demo board was modified slightly.

# DEMO MANUAL DC1822B

## QUICK START PROCEDURE

Demonstration circuit 1822B is easy to set up to evaluate the performance of the LTC3861EUHE. Please refer to Figure 1 for proper measurement equipment setup and follow the procedure below.

1. With power off, connect the input supply, load and meters, as shown in Figure 1. Preset the load to 0A and  $V_{IN}$  supply to be 0V. Place jumpers in the following positions:

<b>JP1</b>	<b>RUN1</b>	<b>ON</b>
<b>JP2</b>	<b>RUN2</b>	<b>ON</b>
<b>JP3</b>	<b>INT BIAS</b>	<b>ON</b>

2. Adjust the input voltage to be between 7V to 14V.  $V_{OUT1}$  should be  $1.5V \pm 2\%$ .  $V_{OUT2}$  should be  $1.2V \pm 2\%$ .

3. Next, apply 25A load to each output and re-measure  $V_{OUT}$ .

4. Once the DC regulation is confirmed, observe the output voltage ripple, load step response, efficiency and other parameters.

NOTE 1. Use the BNC connectors labeled  $V_{OUT1}$  or  $V_{OUT2}$  to measure the output voltage ripple.

NOTE 2. Do not apply the load from the  $V_{OS1+}$  turret to the  $V_{OS1-}$  turret or from the  $V_{OS2+}$  turret to the  $V_{OS2-}$  turret. These are connected to the sense traces for the output voltage. Heavy load currents applied across these turrets may damage these traces.

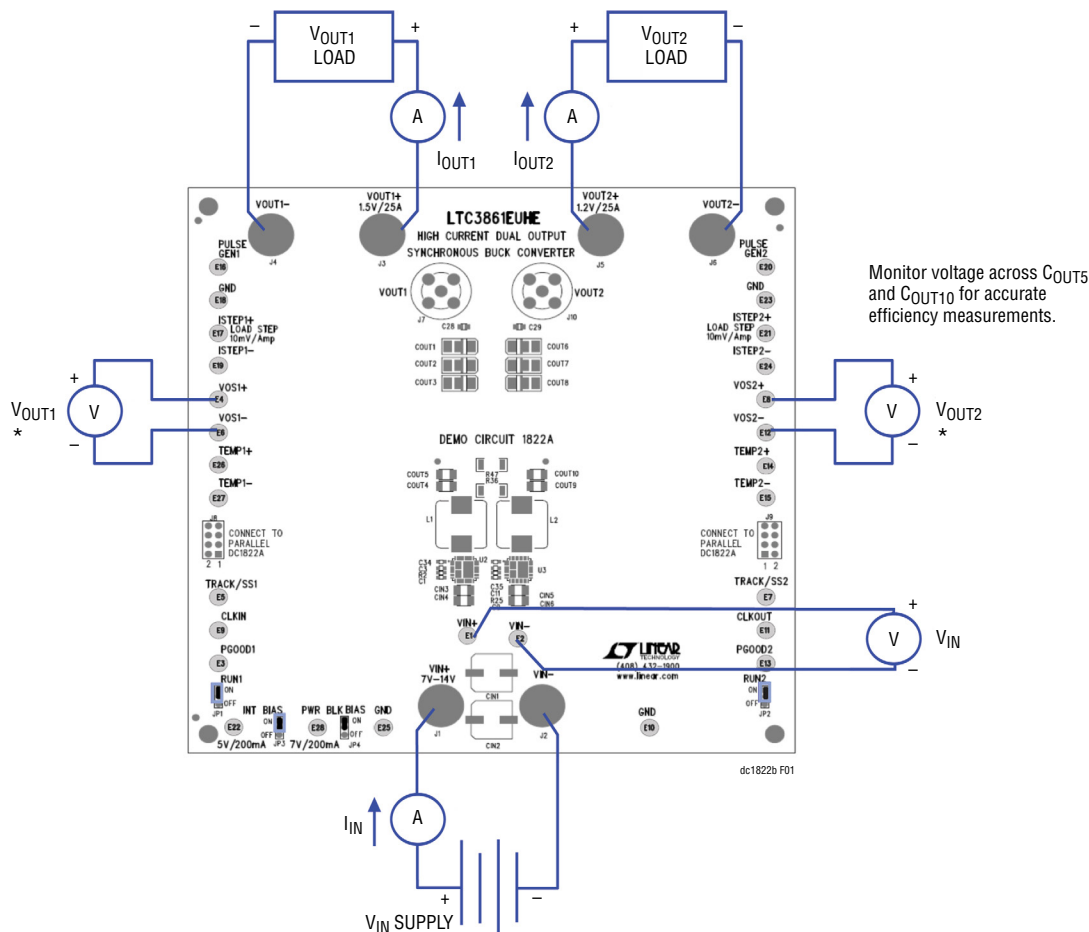
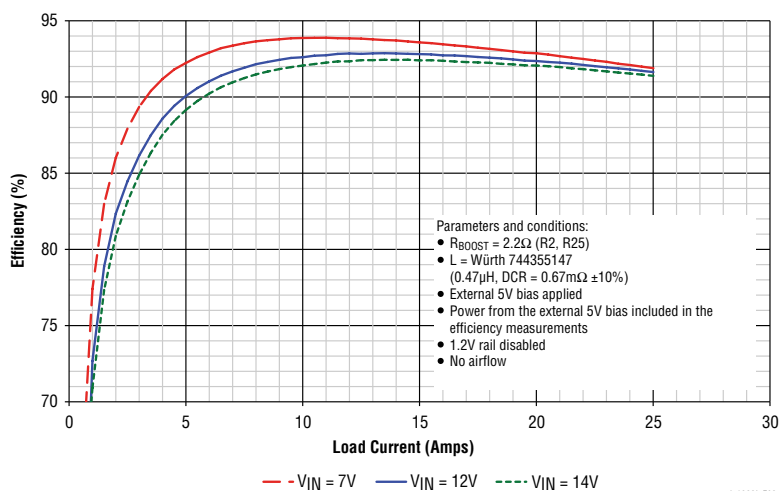


Figure 1. Proper Measurement Equipment Setup

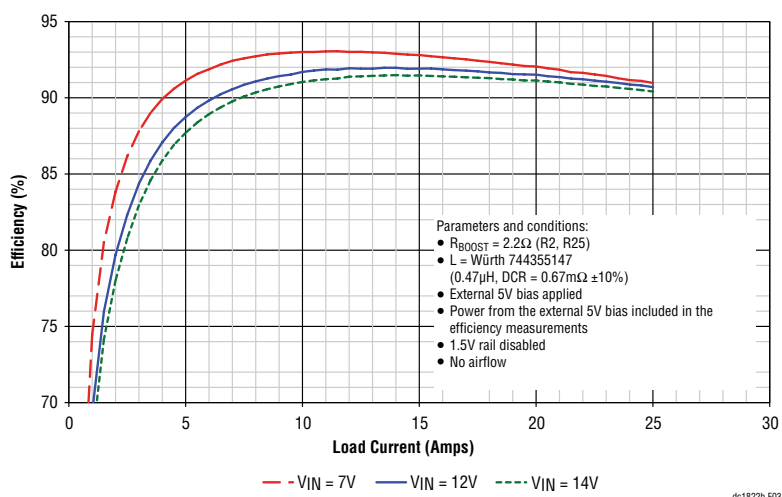
## QUICK START PROCEDURE

### DYNAMIC LOAD CIRCUIT (OPTIONAL)

1. Preset the amplitude of a pulse generator to 0.0V and the duty cycle to 5% or less.
2. Connect the scope to the VOUT BNC connectors for the rail under test with a coax cable. To monitor the load step current, connect the scope probe across the ISTEP± turrets for that rail.
3. Connect the output of the pulse generator to the PULSE GEN turret for the rail under test and connect the return to one of the GND turrets.
4. With the converter running, slowly increase the amplitude of the pulse generator output to provide the desired load step pulse height. The scaling for the load step signal is 10mV/Amp. See Figure 4 and Figure 5 for transient response curves with a 50% load change.

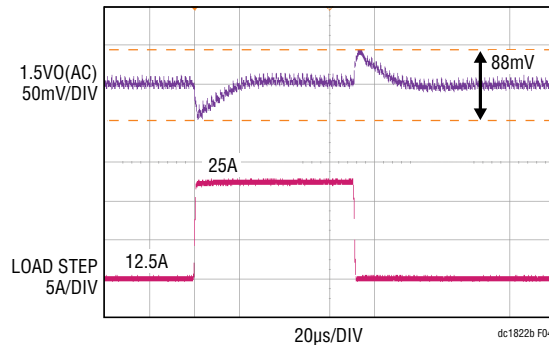


**Figure 2. Efficiency Curves for the 1.5V Rail of the DC1822B.**  
 $f_{sw} = 500\text{kHz}$  with the FDMF6820A DrMOS

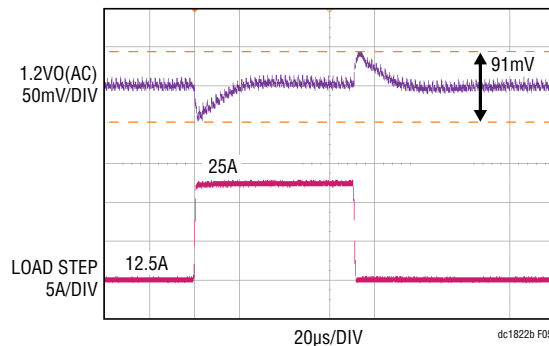


**Figure 3. Efficiency Curves for the 1.2V Rail of the DC1822B.**  
 $f_{sw} = 500\text{kHz}$  with the FDMF6820A DrMOS

## QUICK START PROCEDURE



**Figure 4. Load Step Response of the DC1822B 1.5V Rail at  $V_{IN} = 12V$ .  
 $C_{OUT} = 3 \times$  Sanyo 2R5TPE330M9 ||  $2 \times 100\mu F$  X5R 6.3V 1210,  $L = 0.47\mu H$ ,  
 $f_{SW} = 500kHz$**



**Figure 5. Load Step Response of the DC1822B 1.2V Rail at  $V_{IN} = 12V$ .  
 $C_{OUT} = 3 \times$  Sanyo 2R5TPE330M9 ||  $2 \times 100\mu F$  X5R 6.3V 1210,  $L = 0.47\mu H$ ,  
 $f_{SW} = 500kHz$**

### SINGLE OUTPUT/DUAL PHASE OPERATION

A single output/dual phase converter may be preferred for higher output current applications. The optional components required to tie the phases together are found on the bottom of the schematic shown in Figure 8. To tie the two outputs together, make the following modifications:

1. Stuff  $0\Omega$  at R36 and R47 to tie the two outputs together.
2. Select one rail to be the master.
  - If VOUT1 is the master, then stuff  $0\Omega$  at R51 to disable the error amplifier for phase 2. Also stuff  $0\Omega$  at R52.
  - If VOUT2 is the master, then stuff  $0\Omega$  at R49 to disable the error amplifier for phase 1. Also stuff  $0\Omega$  at R50.
3. Remove the  $0\Omega$  jumper at R13 and stuff a  $100pF$  capacitor at C14 for the IAVG signal.

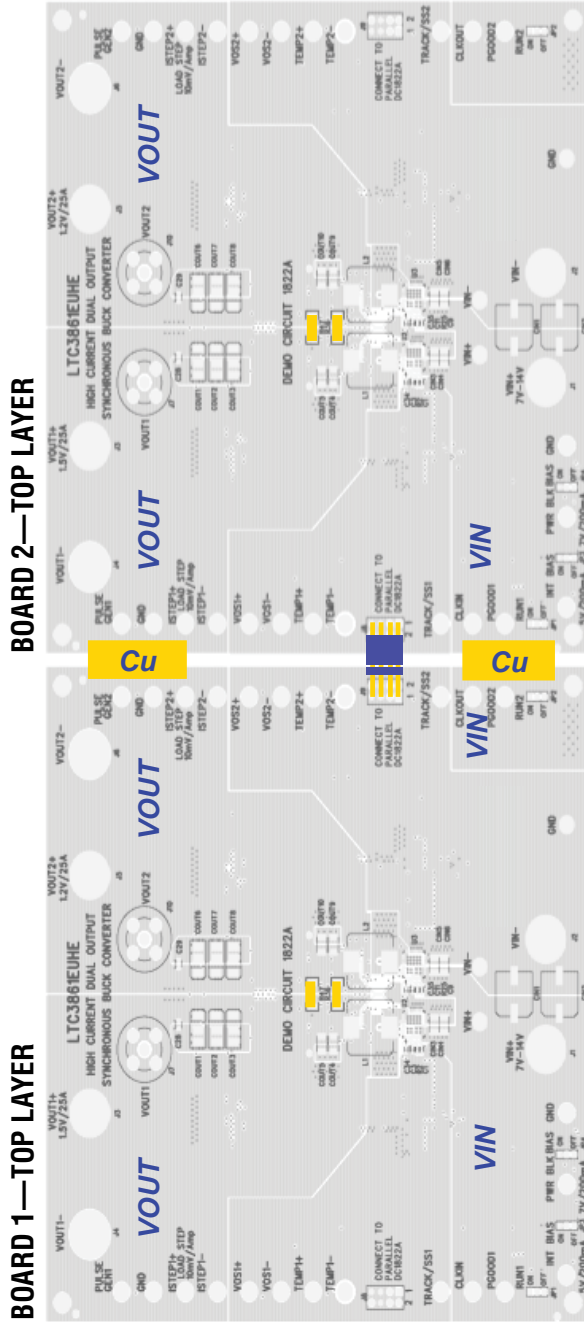
4. Stuff  $0\Omega$  at R53, R48 and R54 to tie the COMP, TRK/SS and RUN pins together.

5. Remove the redundant compensation components.

### PARALLELING BOARDS

The DC1822B demo boards can be tied together to form a converter with up to 12 phases. To tie the boards together, place the boards side-by-side and then connect the boards by connecting J8 of one board to J9 of the other. This will connect the IAVG, COMP, TRK/SS and signal ground signals together. Next, use copper strips to tie the VOUT planes, the VIN planes and GND planes of the two adjacent boards together. The board has exposed copper along the edges of the board for this purpose. Figure 6 shows how to set up a 4-phase converter and Figure 7 shows how to set up a 3-phase plus single phase converter.

QUICK START PROCEDURE



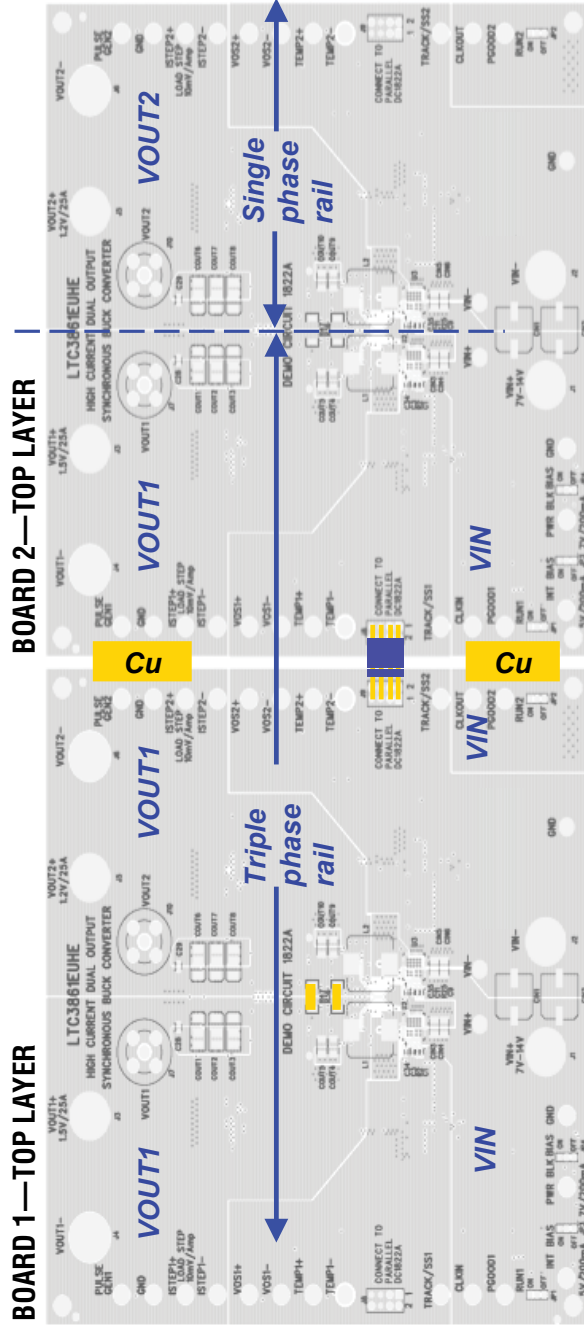
Note: Tie GND shapes together on the bottom layer by using the exposed copper along the edge of the board.

BOARD #1	VOUT1 TO VOUT2 R36 & R47	0.0mΩ	ILIM1 TO VCC R50	NS	ILIM1 R R17	STUFF	ILIM2 TO VCC R52	0Ω	ILIM2 R R24	NS	FB1 TO VCC R49	0Ω	FB2 TO VCC R51	0Ω	TRK/SS1 TO TRK/SS2 R48	0Ω	COMP1 TO COMP2 R53	0Ω	RUN1 TO RUN2 R54	0Ω	PHASE MODE SETTING R41	NS	IAVG PIN R13	100pF
BOARD #2		0.0mΩ	NS <td>STUFF</td> <td>ILIM1 R R17</td> <td>STUFF</td> <td>ILIM2 TO VCC R52</td> <td>0Ω</td> <td>ILIM2 R R24</td> <td>NS</td> <td>FB1 TO VCC R49</td> <td>0Ω</td> <td>FB2 TO VCC R51</td> <td>0Ω</td> <td>TRK/SS1 TO TRK/SS2 R48</td> <td>0Ω</td> <td>COMP1 TO COMP2 R53</td> <td>0Ω</td> <td>RUN1 TO RUN2 R54</td> <td>0Ω</td> <td>PHASE MODE SETTING R42</td> <td>NS</td> <td>IAVG PIN R13</td> <td>100pF</td>	STUFF	ILIM1 R R17	STUFF	ILIM2 TO VCC R52	0Ω	ILIM2 R R24	NS	FB1 TO VCC R49	0Ω	FB2 TO VCC R51	0Ω	TRK/SS1 TO TRK/SS2 R48	0Ω	COMP1 TO COMP2 R53	0Ω	RUN1 TO RUN2 R54	0Ω	PHASE MODE SETTING R42	NS	IAVG PIN R13	100pF

dc1822a R06

Figure 6. Setup of a 4-Phase Converter; Phase 1 of Board 1 is the Master

## QUICK START PROCEDURE



Note: Tie GND shapes together on the bottom layer by using the exposed copper along the edge of the board.

	VOUT1 TO VOUT2 R36 & R47	ILIM1 TO VCC R50	ILIM1 R R17	ILIM2 TO VCC R52	ILIM2 R R24	FB1 TO VCC R49	FB2 TO VCC R51	TRK/SS1 TO TRK/SS2 R48	COMP1 TO COMP2 R53	RUN1 TO RUN2 R54	PHASE MODE SETTING R41	I AVG PIN R13
BOARD #1	0.0mΩ	NS	STUFF	0Ω	NS	NS	0Ω	0Ω	0Ω	0Ω	NS	C14
BOARD #2	NS	NS	STUFF	NS	STUFF	0Ω	NS	NS	NS	NS	0Ω	NS

Figure 7. Setup of a 3-Phase Plus Single Phase Converter; Phase 1 of Board 1 is the Master of the 3-Phase Rail

dc1822a-r07

## PARTS LIST

ITEM	QTY	REFERENCE	PART DESCRIPTION	MANUFACTURER/PART NUMBER
<b>DC1822B Required Circuit Components</b>				
1	4	C1, C7, C8, C9	CAP, 0.22 $\mu$ F, 10%, 25V, X7R, 0603	AVX 06033C224KAT2A
2	2	C1-1, C1-2	CAP, 1500pF, 10%, 50V, GOG, 0603	MURATA,GRM1885C1H152JA01D
3	2	C2-1, C2-2	CAP, 100pF, 5%, 25V, NPO, 0603	AVX 06033A101JAT2A
4	2	C28, C29	CAP, 10 $\mu$ F, 20%, 6.3V, X5R, 0805	AVX 08056D106MAT2A
5	4	C3, C11, C34, C35	CAP, 2.2 $\mu$ F, 10%, 16V, X7R, 0603	MURATA GRM188R61C225KE15D
6	2	C3-1, C3-2	CAP, 3300pF, 10%, 50V X7R, 0603	AVX 06035C332KAT2A
7	1	C6	CAP, 1 $\mu$ F, 20%, 25V, X5R, 0603	AVX 06033D105MAT2A
8	1	CIN2	CAP, 180 $\mu$ F, 20%, 16V, OSCON	SANYO 16SVP180MX
9	4	CIN3, CIN4, CIN5, CIN6	CAP, 22 $\mu$ F, 20%, 16V, X5R, 1210	AVX 1210YD226MAT2A
10	6	COU1-COU3, COU6-COU8	CAP, 330 $\mu$ F, 20%, 2.5V POSCAP 7343	SANYO 2R5TPE330M9
11	4	COU4, COU5, COU9, COU10	CAP, 100 $\mu$ F, 20%, 6.3V, X5R, 1210	AVX 12106D107MAT2A
12	2	L1,L2	IND, 0.47 $\mu$ H, 20%	WURTH 744355147
13	2	R1, R45	RES, 18.2k, 1%, 1/10W, 0603	VISHAY CRCW060318K2FKEA
14	4	R11, R18, R39, R43	RES, 10 $\Omega$ , 1%, 1/10W, 0603	VISHAY CRCW060310R0FKEA
15	2	R17, R24	RES, 53.6k, 1%, 1/10W, 0603	VISHAY CRCW060353K6FKEA
16	2	R2, R25	RES, 2.2 $\Omega$ , 1%, 1/16W, 0603	VISHAY CRCW06032R20FKEA
17	2	R20, R38	RES, 2.87k, 1%, 1/10W, 0603	VISHAY CRCW06032K87FKEA
18	1	R2-1	RES, 9.76k, 1%, 1/16W, 0603	VISHAY CRCW06039K76FKEA
19	1	R2-2	RES, 9.31k, 1%, 1/16W, 0603	VISHAY CRCW06039K31FKEA
20	3	R3, R16, R26	RES, 1 $\Omega$ , 1%, 1/10W, 0603	YAGEO RC0603FR-071RL
21	2	R3-1, R3-2	RES, 280 $\Omega$ , 1%, 1/10W, 0603	VISHAY CRCW0603280R0FKEA
22	1	R37	RES, 34k, 1%, 1/10W, 0603	VISHAY CRCW060334K0FKEA
23	2	R8, R44	RES, 100k, 1%, 1/10W, 0603	VISHAY CRCW0603100KFKEA
24	9	R9, R12, R13, R19, R21-R23, R32, R73	RES, 0 $\Omega$ , JUMPER, 0603	VISHAY CRCW06030000Z0EA
25	11	RB-1, RB-2, RT-2, R1-1, R1-2, R4-R6, R29, R30, R46	RES, 10k, 1%, 1/10W, 0603	VISHAY CRCW060310K0FKEA
26	1	RT-1	RES, 15k, 1%, 1/10W, 0603	YAGEO RC0603FR-0715KL
27	1	U1	I.C., LTC3861EUHE	ANALOG DEVICES LTC3861EUHE#PBF
28	2	U2, U3	MOSFET, DrMOS, DC-DC, 3.3V, PWM	FAIRCHILD FDMF6820A
<b>Additional Circuit Components</b>				
1	1	C17	CAP, 0.22 $\mu$ F, 10%, 25V, X7R, 0603	AVX 06033C224KAT2A
2	1	C18	CAP, 1 $\mu$ F, 20%, 25V, X5R, 0603	AVX 06033D105MAT2A
3	1	C19	CAP, 22 $\mu$ F, 20%, 16V, X5R, 1210	AVX 1210YD226MAT2A
4	2	C2, C4, C5, C10, C12-C16, C20, C22-C25, C27, C30-C33	CAP, 0603	OPT
5	1	C21	CAP, 22pF, 10%, 25V, NPO, 0603	AVX 06033A220KAT2A
6	1	C26	CAP, 1 $\mu$ F, 20%, 25V, X5R, 0603	AVX 06033D105MAT2A
7	0	CIN1	CAP, SVP, F8	OPT
8	0	CIN7-CIN14, COU11-COU17	CAP, 1210	OPT
9	0	COU15-COU17, COU22-COU24	CAP, 7343	OPT
10	0	D1	DIODE, BAV170, SOT23	OPT

# DEMO MANUAL DC1822B

## PARTS LIST

ITEM	QTY	REFERENCE	PART DESCRIPTION	MANUFACTURER/PART NUMBER
11	0	D2, D3	CMDSH-3	OPT
12	1	L3	IND, 33 $\mu$ H, -53DLC	TOKO A914BYW-330M=P3
13	0	L4	INDUCTOR, -53LDC	OPT
14	0	PB1	DC/DC Converters, D12S1R845A	OPT
15	2	Q1, Q2	MOSFET, 30V N-CHANNEL, DPAK	VISHAY SUD50N03-12P-E3
16	0	Q3, Q4, Q7, Q8	BSC050NE2LS	OPT
17	0	Q5, Q6, Q9, Q10	BSC010NE2LS	OPT
18	0	R10, R14, R15, R27, R28, R31, R33-R35, R41, R42, R47-R55, R62, R64-R67, R69, R71, R72, R74-R81	RES, 0603	OPT
19	2	R56, R58	RES, 10k, 1%, 1/10W, 0603	VISHAY CRCW060310K0FKEA
20	2	R57, R60	RES, 0.010 $\Omega$ , 1%, 1W, 2010	IRC LRC-LRF2010LF-01-R010-F
21	1	R59	RES, 0 $\Omega$ , JUMPER, 1206	VISHAY CRCW12060000Z0EA
22	1	R61	RES, 604k, 1%, 1/16W, 0603	VISHAY CRCW0603604KFKEA
23	1	R63	RES, 200k, 1%, 1/16W, 0603	VISHAY CRCW0603200KFKEA
24	1	U4	BUCK REGULATOR, LT3470ETS8	ANALOG DEVICES LT3470ETS8
25	0	U5	BUCK REGULATOR, LT3470ETS8	OPT
26	0	U8, U9	N-CHANNEL MOSFET DRIVER, LTC4449	OPT

### Hardware

1	27	E1-E27	TESTPOINT, TURRET, 0.095"	MILL-MAX 2501-2-00-80-00-00-07-0
2	6	J1-J6	STUD, TEST PIN	PEM KFH-032-10
3	12	J1-J6	NUT, BRASS PL #10-32	ANY #10-32M/S
4	6	J1-J6	RING, LUG #10	KEYSTONE 8205
5	6	J1-J6	WASHER, TIN, PLATED BRASS	ANY
6	2	J7, J10	CON, BNC, 5 PINS	CONNEX 112404
7	1	J8	HEADER, DOBL ROW, RT ANGLE, 2x4, 8 PIN	MILL-MAX 802-10-008-20-001000
8	1	J9	SOCKET, DBL ROW, RT ANGLE, 2x4, 8 PIN	MILL-MAX 803-43-008-20-001000
9	4	JP1, JP2, JP3, JP4	HEADER, 3 PIN, 0.079" SINGLE ROW	SAMTEC TMM-103-02-L-S
10	4	MTGS AT 4 CORNERS	STAND-OFF, NYLON 0.5"	KEYSTONE 8833 (SNAP-ON)
11	4	XJP1, XJP2, XJP3, XJP4	SHUNT, 0.079" CENTER	SAMTEC 2SN-BK-G



SCHEMATIC DIAGRAM

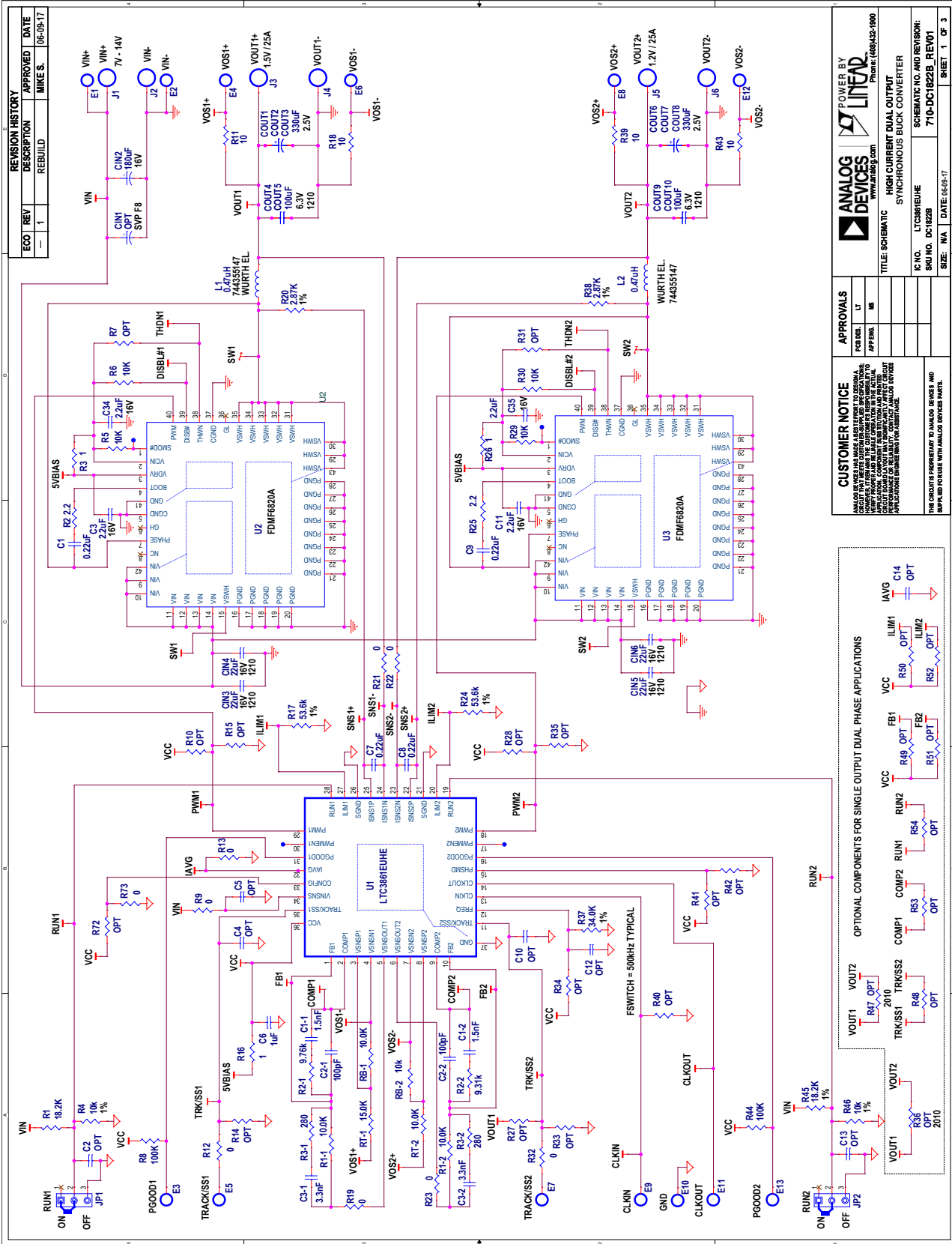


Figure 8. DC1822B Demo Circuit Schematic



## SCHEMATIC DIAGRAM

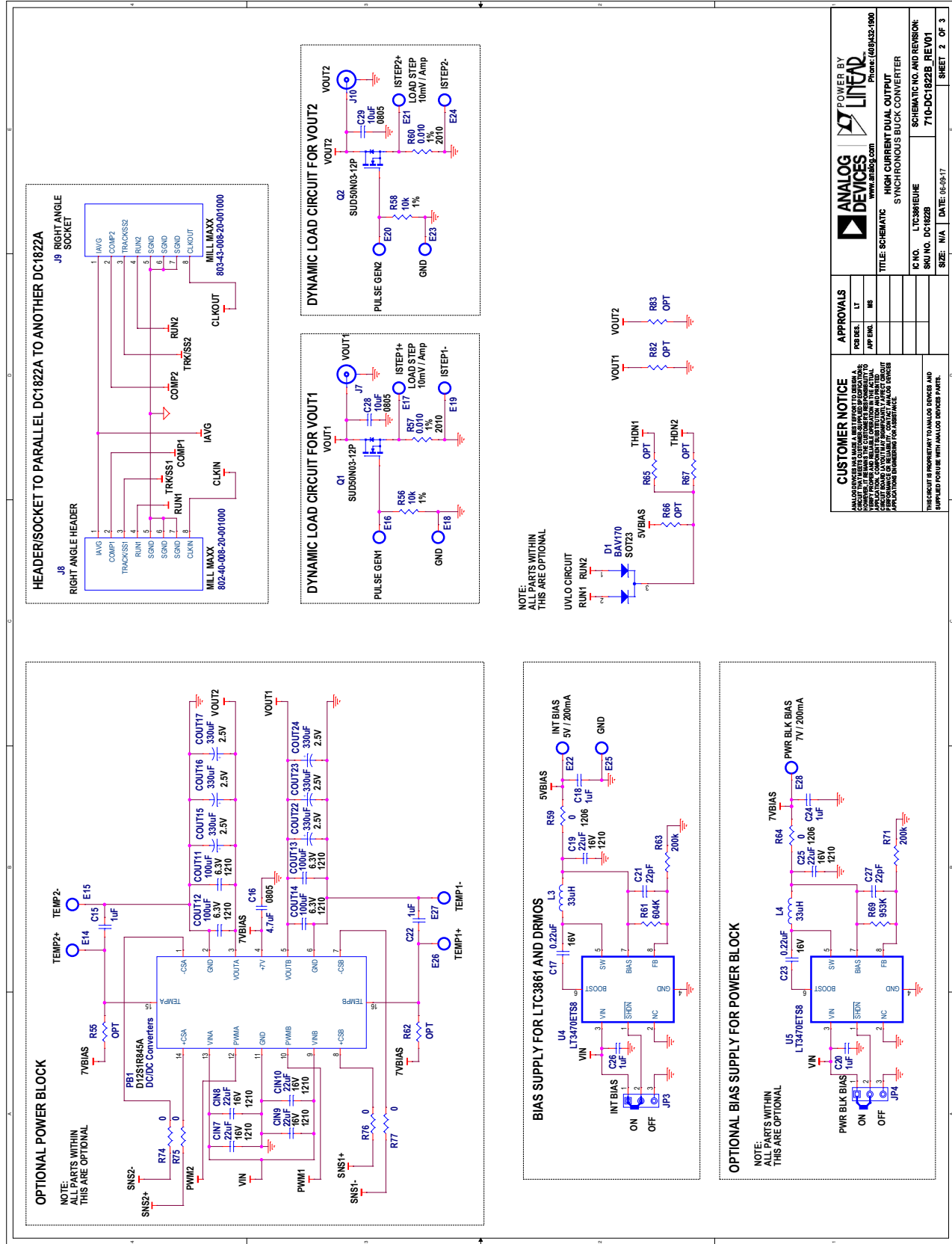
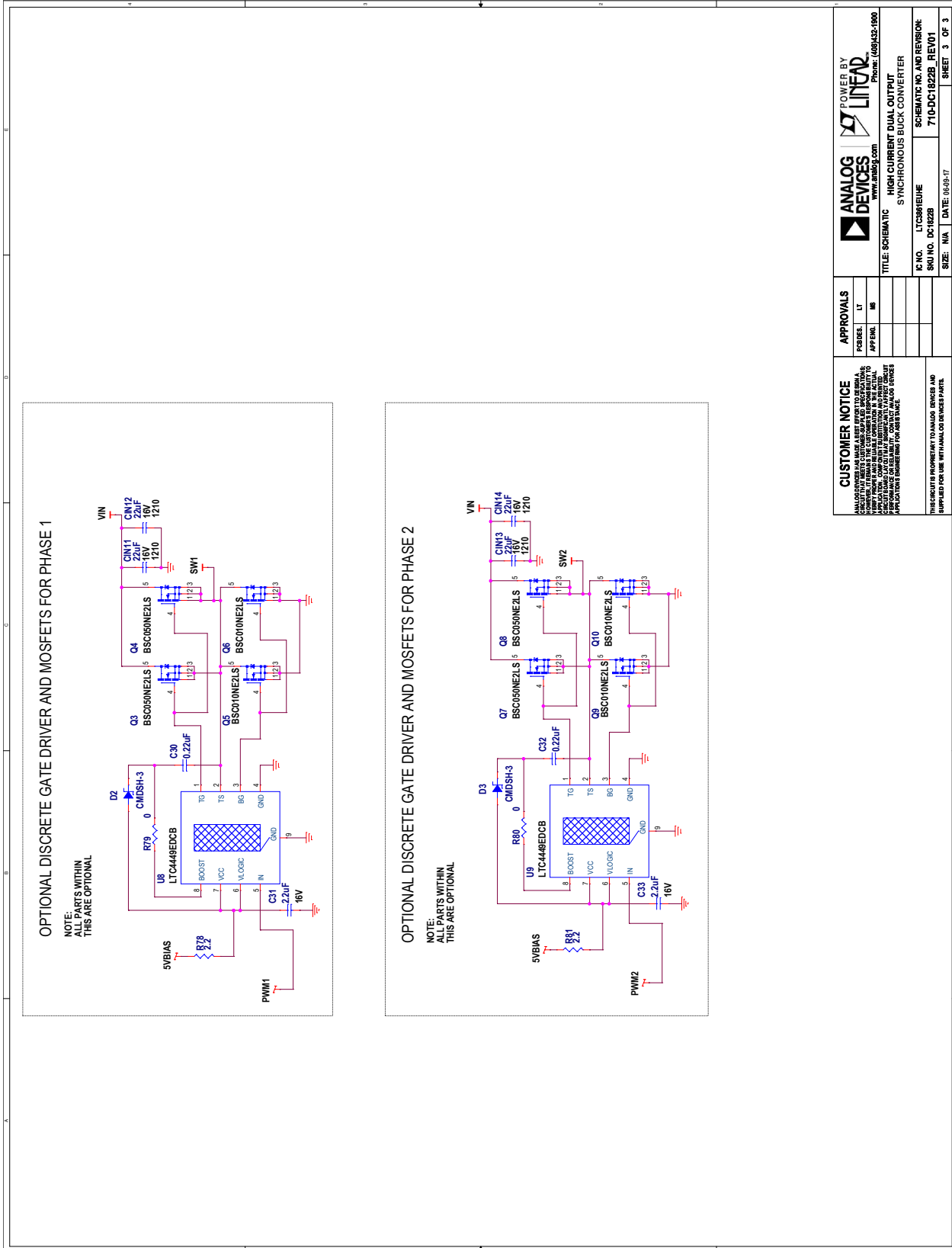


Figure 9. DC1822B Demo Circuit Schematic

TITLE: SCHEMATIC HIGH CURRENT DUAL OUTPUT SYNCHRONOUS BUCK CONVERTER		IC NO. LTC3861EHE SCHEMATIC NO. AND REVISION: 710-DC1822B REV11	
PCB DES. LT		DATE: 06-06-17	
APP ENG. MS		SIZE: 1/4A	
SHEET 2 OF 3		SOURCE: 009432-1000	

**CUSTOMER NOTICE**  
 ANALOG DEVICES AND LINEAR ARE NOT RESPONSIBLE FOR DESIGN OR OPERATION OF THE CUSTOMER'S SYSTEMS. THE CUSTOMER IS RESPONSIBLE FOR THE PROPER DESIGN AND OPERATION OF THEIR SYSTEMS. ANALOG DEVICES AND LINEAR ARE NOT RESPONSIBLE FOR ANY DAMAGE TO THE CUSTOMER'S SYSTEMS OR TO THE CUSTOMER'S PERSONNEL OR PROPERTY. ANALOG DEVICES AND LINEAR WILL NOT BE RESPONSIBLE FOR ANY DAMAGE TO THE CUSTOMER'S SYSTEMS OR TO THE CUSTOMER'S PERSONNEL OR PROPERTY. ANALOG DEVICES AND LINEAR WILL NOT BE RESPONSIBLE FOR ANY DAMAGE TO THE CUSTOMER'S SYSTEMS OR TO THE CUSTOMER'S PERSONNEL OR PROPERTY.

SCHEMATIC DIAGRAM



<b>CUSTOMER NOTICE</b> <small>ANALOG DEVICES AND ITS REPRESENTATIVES ASSUME NO LIABILITY FOR THE USE OF ANY INFORMATION CONTAINED HEREIN IN CONNECTION WITH ANY PRODUCTS. THE INFORMATION CONTAINED HEREIN IS PROVIDED AS IS WITHOUT WARRANTY OF ANY KIND, INCLUDING THE IMPLIED WARRANTIES OF MERCHANTABILITY AND FITNESS FOR A PARTICULAR PURPOSE. CONSULT AN ANALOG DEVICES APPLICATIONS ENGINEER FOR ASSISTANCE.</small>		<b>APPROVALS</b> DESIGNED BY: LI APPR'D BY: MB
<b>POWER BY</b> <b>LINEAR</b> <small>www.analog.com Phone: (603) 552-1900</small>		TITLE: SCHEMATIC HIGH CURRENT DUAL OUTPUT SYNCHRONOUS BUCK CONVERTER
IC NO.: LTC3891EUNE SKU NO.: DC1822B	SCHEMATIC NO. AND REVISION: 710-DC1822B_REV01	DATE: 05-09-17 SHEET: 3 OF 3

Figure 10. DC1822B Demo Circuit Schematic



## ESD Caution

**ESD (electrostatic discharge) sensitive device.** Charged devices and circuit boards can discharge without detection. Although this product features patented or proprietary protection circuitry, damage may occur on devices subjected to high energy ESD. Therefore, proper ESD precautions should be taken to avoid performance degradation or loss of functionality.

## Legal Terms and Conditions

By using the evaluation board discussed herein (together with any tools, components documentation or support materials, the "Evaluation Board"), you are agreeing to be bound by the terms and conditions set forth below ("Agreement") unless you have purchased the Evaluation Board, in which case the Analog Devices Standard Terms and Conditions of Sale shall govern. Do not use the Evaluation Board until you have read and agreed to the Agreement. Your use of the Evaluation Board shall signify your acceptance of the Agreement. This Agreement is made by and between you ("Customer") and Analog Devices, Inc. ("ADI"), with its principal place of business at One Technology Way, Norwood, MA 02062, USA. Subject to the terms and conditions of the Agreement, ADI hereby grants to Customer a free, limited, personal, temporary, non-exclusive, non-sublicensable, non-transferable license to use the Evaluation Board FOR EVALUATION PURPOSES ONLY. Customer understands and agrees that the Evaluation Board is provided for the sole and exclusive purpose referenced above, and agrees not to use the Evaluation Board for any other purpose. Furthermore, the license granted is expressly made subject to the following additional limitations: Customer shall not (i) rent, lease, display, sell, transfer, assign, sublicense, or distribute the Evaluation Board; and (ii) permit any Third Party to access the Evaluation Board. As used herein, the term "Third Party" includes any entity other than ADI, Customer, their employees, affiliates and in-house consultants. The Evaluation Board is NOT sold to Customer; all rights not expressly granted herein, including ownership of the Evaluation Board, are reserved by ADI. CONFIDENTIALITY. This Agreement and the Evaluation Board shall all be considered the confidential and proprietary information of ADI. Customer may not disclose or transfer any portion of the Evaluation Board to any other party for any reason. Upon discontinuation of use of the Evaluation Board or termination of this Agreement, Customer agrees to promptly return the Evaluation Board to ADI. ADDITIONAL RESTRICTIONS. Customer may not disassemble, decompile or reverse engineer chips on the Evaluation Board. Customer shall inform ADI of any occurred damages or any modifications or alterations it makes to the Evaluation Board, including but not limited to soldering or any other activity that affects the material content of the Evaluation Board. Modifications to the Evaluation Board must comply with applicable law, including but not limited to the RoHS Directive. TERMINATION. ADI may terminate this Agreement at any time upon giving written notice to Customer. Customer agrees to return to ADI the Evaluation Board at that time. LIMITATION OF LIABILITY. THE EVALUATION BOARD PROVIDED HEREUNDER IS PROVIDED "AS IS" AND ADI MAKES NO WARRANTIES OR REPRESENTATIONS OF ANY KIND WITH RESPECT TO IT. ADI SPECIFICALLY DISCLAIMS ANY REPRESENTATIONS, ENDORSEMENTS, GUARANTEES, OR WARRANTIES, EXPRESS OR IMPLIED, RELATED TO THE EVALUATION BOARD INCLUDING, BUT NOT LIMITED TO, THE IMPLIED WARRANTY OF MERCHANTABILITY, TITLE, FITNESS FOR A PARTICULAR PURPOSE OR NON-INFRINGEMENT OF INTELLECTUAL PROPERTY RIGHTS. IN NO EVENT WILL ADI AND ITS LICENSORS BE LIABLE FOR ANY INCIDENTAL, SPECIAL, INDIRECT, OR CONSEQUENTIAL DAMAGES RESULTING FROM CUSTOMER'S POSSESSION OR USE OF THE EVALUATION BOARD, INCLUDING BUT NOT LIMITED TO LOST PROFITS, DELAY COSTS, LABOR COSTS OR LOSS OF GOODWILL. ADI'S TOTAL LIABILITY FROM ANY AND ALL CAUSES SHALL BE LIMITED TO THE AMOUNT OF ONE HUNDRED US DOLLARS (\$100.00). EXPORT. Customer agrees that it will not directly or indirectly export the Evaluation Board to another country, and that it will comply with all applicable United States federal laws and regulations relating to exports. GOVERNING LAW. This Agreement shall be governed by and construed in accordance with the substantive laws of the Commonwealth of Massachusetts (excluding conflict of law rules). Any legal action regarding this Agreement will be heard in the state or federal courts having jurisdiction in Suffolk County, Massachusetts, and Customer hereby submits to the personal jurisdiction and venue of such courts. The United Nations Convention on Contracts for the International Sale of Goods shall not apply to this Agreement and is expressly disclaimed.