

RELIABILITY REPORT
FOR
MAX3486ExxA
PLASTIC ENCAPSULATED DEVICES

June 4, 2002

MAXIM INTEGRATED PRODUCTS

120 SAN GABRIEL DR.
SUNNYVALE, CA 94086

Written by



Jim Pedicord
Quality Assurance
Reliability Lab Manager

Reviewed by



Bryan J. Preeshl
Quality Assurance
Executive Director

Conclusion

The MAX3486E successfully meets the quality and reliability standards required of all Maxim products. In addition, Maxim's continuous reliability monitoring program ensures that all outgoing product will continue to meet Maxim's quality and reliability standards.

Table of Contents

I.Device Description	V.Quality Assurance Information
II.Manufacturing Information	VI.Reliability Evaluation
III.Packaging Information	
IV.Die InformationAttachments

I. Device Description

A. General

The MAX3486E is a $\pm 15\text{kV}$ ESD-protected, +3.3V, low-power transceivers for RS-485 and RS-422 communications. The device contains one driver and one receiver. The partially slew-rate-limited MAX3486E transmits up to 2.5Mbps.

The device features enhanced electrostatic discharge (ESD) protection. All transmitter outputs and receiver inputs are protected to $\pm 15\text{kV}$ using IEC 1000-4-2 Air-Gap Discharge, $\pm 8\text{kV}$ using IEC 1000-4-2 Contact Discharge, and $\pm 15\text{kV}$ using the Human Body Model.

Drivers are short-circuit current limited and are protected against excessive power dissipation by thermal shutdown circuitry that places the driver outputs into a high-impedance state. The receiver input has a fail-safe feature that guarantees a logic-high output if both inputs are open circuit.

The MAX3486E is designed for half-duplex communication.

B. Absolute Maximum Ratings

<u>Item</u>	<u>Rating</u>
Supply Voltage (V_{CC})	7V
Control Input Voltage (/RE, DE)	-0.3V to 7V
Driver Input Voltage (DI)	-0.3V to 7V
Driver Output Voltage (A, B, Y, Z)	-7.5V to 12.5V
Receiver Input Voltage (A, B)	-7.5V to 12.5V
Receiver Output Voltage (RO)	-0.3V to ($V_{CC} + 0.3\text{V}$)
Storage Temp.	-65°C to +160°C
Lead Temp. (10 sec.)	+300°C
Power Dissipation	471mW
Derates above +70°C	5.88mW/°C
Continuous Power Dissipation (+70°C)	
8-Pin DIP	727mW
8-Pin NSO	471mW
Derates above +70°C	
8-Pin DIP	9.09mW/°C
8-Pin NSO	5.88mW/°C

II. Manufacturing Information

A. Description/Function:	3.3V-Powered, +/-15KV ESD-Protected 2.5Mbps and Slew-Rate-Limited True RS-485/RS-422 Transceiver
B. Process:	SG3 (Standard 3 micron silicon gate CMOS)
C. Number of Device Transistors:	761
D. Fabrication Location:	California or Oregon, USA
E. Assembly Location:	Philippines, Malaysia, or Korea
F. Date of Initial Production:	April, 1999

III. Packaging Information

A. Package Type:	8 Lead PDIP	8 Lead NSO
B. Lead Frame:	Copper	Copper
C. Lead Finish:	Solder Plate	Solder Plate
D. Die Attach:	Silver-filled Epoxy	Silver-filled Epoxy
E. Bondwire:	Gold (1.3 mil dia.)	Gold (1.3 mil dia.)
F. Mold Material:	Epoxy with silica filler	Epoxy with silica filler
G. Assembly Diagram:	Buildsheet # 05-1901-0083	Buildsheet #05-1901-0084
H. Flammability Rating:	Class UL94-V0	Class UL94-V0
I. Classification of Moisture Sensitivity per JEDEC standard JESD22-A112:	Level 1	Level 1

IV. Die Information

A. Dimensions:	86 x 146 mils
B. Passivation:	Si ₃ N ₄ /SiO ₂ (Silicon nitride/ Silicon dioxide)
C. Interconnect:	Aluminum/Si (Si = 1%)
D. Backside Metallization:	None
E. Minimum Metal Width:	3 microns (as drawn)
F. Minimum Metal Spacing:	3 microns (as drawn)
G. Bondpad Dimensions:	5 mil. Sq.
H. Isolation Dielectric:	SiO ₂
I. Die Separation Method:	Wafer Saw

V. Quality Assurance Information

- A. Quality Assurance Contacts: Jim Pedicord (Reliability Lab Manager)
Bryan Preeshl (Executive Director of QA)
Kenneth Huening (Vice President)
- B. Outgoing Inspection Level: 0.1% for all electrical parameters guaranteed by the Datasheet.
0.1% For all Visual Defects.
- C. Observed Outgoing Defect Rate: < 50 ppm
- D. Sampling Plan: Mil-Std-105D

VI. Reliability Evaluation

A. Accelerated Life Test

The results of the 135°C biased (static) life test are shown in **Table 1**. Using these results, the Failure Rate (λ) is calculated as follows:

$$\lambda = \frac{1}{\text{MTTF}} = \frac{1.83}{192 \times 4389 \times 960 \times 2} \quad (\text{Chi square value for MTTF upper limit})$$

↓
Temperature Acceleration factor assuming an activation energy of 0.8eV

$$\lambda = 1.13 \times 10^{-9} \quad \lambda = 1.13 \text{ F.I.T. (60\% confidence level @ 25°C)}$$

This low failure rate represents data collected from Maxim's reliability qualification and monitor programs. Maxim also performs weekly Burn-In on samples from production to assure reliability of its processes. The reliability required for lots which receive a burn-in qualification is 59 F.I.T. at a 60% confidence level, which equates to 3 failures in an 80 piece sample. Maxim performs failure analysis on rejects from lots exceeding this level. The attached Burn-In Schematic (Spec. # 06-5082) shows the static circuit used for this test. Maxim also performs 1000 hour life test monitors quarterly for each process. This data is published in the Product Reliability Report (**RR-1M**).

B. Moisture Resistance Tests

Maxim evaluates pressure pot stress from every assembly process during qualification of each new design. Pressure Pot testing must pass a 20% LTPD for acceptance. Additionally, industry standard 85°C/85%RH or HAST tests are performed quarterly per device/package family.

C. E.S.D. and Latch-Up Testing

The RS17-4 die type has been found to have all pins able to withstand a transient pulse of $\pm 1500\text{V}$, per Mil-Std-883 Method 3015 (reference attached ESD Test Circuit). Latch-Up testing has shown that this device withstands a current of $\pm 250\text{mA}$.

Table 1
Reliability Evaluation Test Results

MAX3486ExxA

TEST ITEM	TEST CONDITION	FAILURE IDENTIFICATION	PACKAGE	SAMPLE SIZE	NUMBER OF FAILURES
Static Life Test (Note 1)					
	Ta = 135°C Biased Time = 192 hrs.	DC Parameters & functionality		960	0
Moisture Testing (Note 2)					
Pressure Pot	Ta = 121°C P = 15 psi. RH= 100% Time = 168hrs.	DC Parameters & functionality		100	0
85/85	Ta = 85°C RH = 85% Biased Time = 1000hrs.	DC Parameters & functionality		77	0
Mechanical Stress (Note 2)					
Temperature Cycle	-65°C/150°C 1000 Cycles Method 1010	DC Parameters		77	0

Note 1: Life Test Data may represent plastic DIP qualification lots.

Note 2: Generic package/process data.

Attachment #1

TABLE II. Pin combination to be tested. 1/ 2/

	Terminal A (Each pin individually connected to terminal A with the other floating)	Terminal B (The common combination of all like-named pins connected to terminal B)
1.	All pins except V_{PS1} <u>3/</u>	All V_{PS1} pins
2.	All input and output pins	All other input-output pins

1/ Table II is restated in narrative form in 3.4 below.

2/ No connects are not to be tested.

3/ Repeat pin combination I for each named Power supply and for ground

(e.g., where V_{PS1} is V_{DD} , V_{CC} , V_{SS} , V_{BB} , GND, $+V_S$, $-V_S$, V_{REF} , etc).

3.4 Pin combinations to be tested.

- a. Each pin individually connected to terminal A with respect to the device ground pin(s) connected to terminal B. All pins except the one being tested and the ground pin(s) shall be open.
- b. Each pin individually connected to terminal A with respect to each different set of a combination of all named power supply pins (e.g., V_{SS1} , or V_{SS2} or V_{SS3} or V_{CC1} , or V_{CC2}) connected to terminal B. All pins except the one being tested and the power supply pin or set of pins shall be open.
- c. Each input and each output individually connected to terminal A with respect to a combination of all the other input and output pins connected to terminal B. All pins except the input or output pin being tested and the combination of all the other input and output pins shall be open.

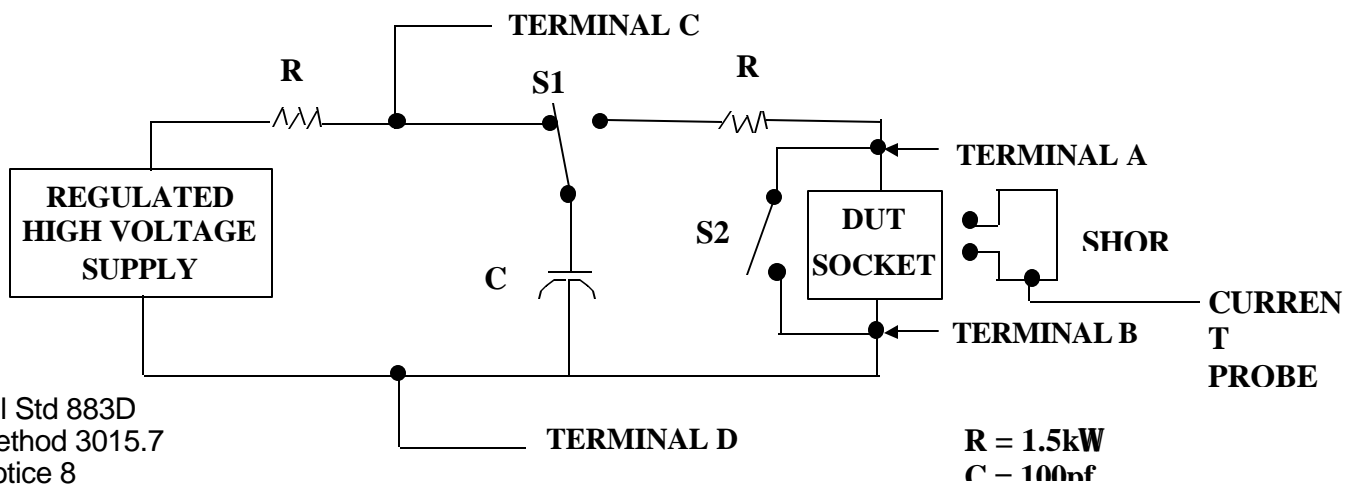

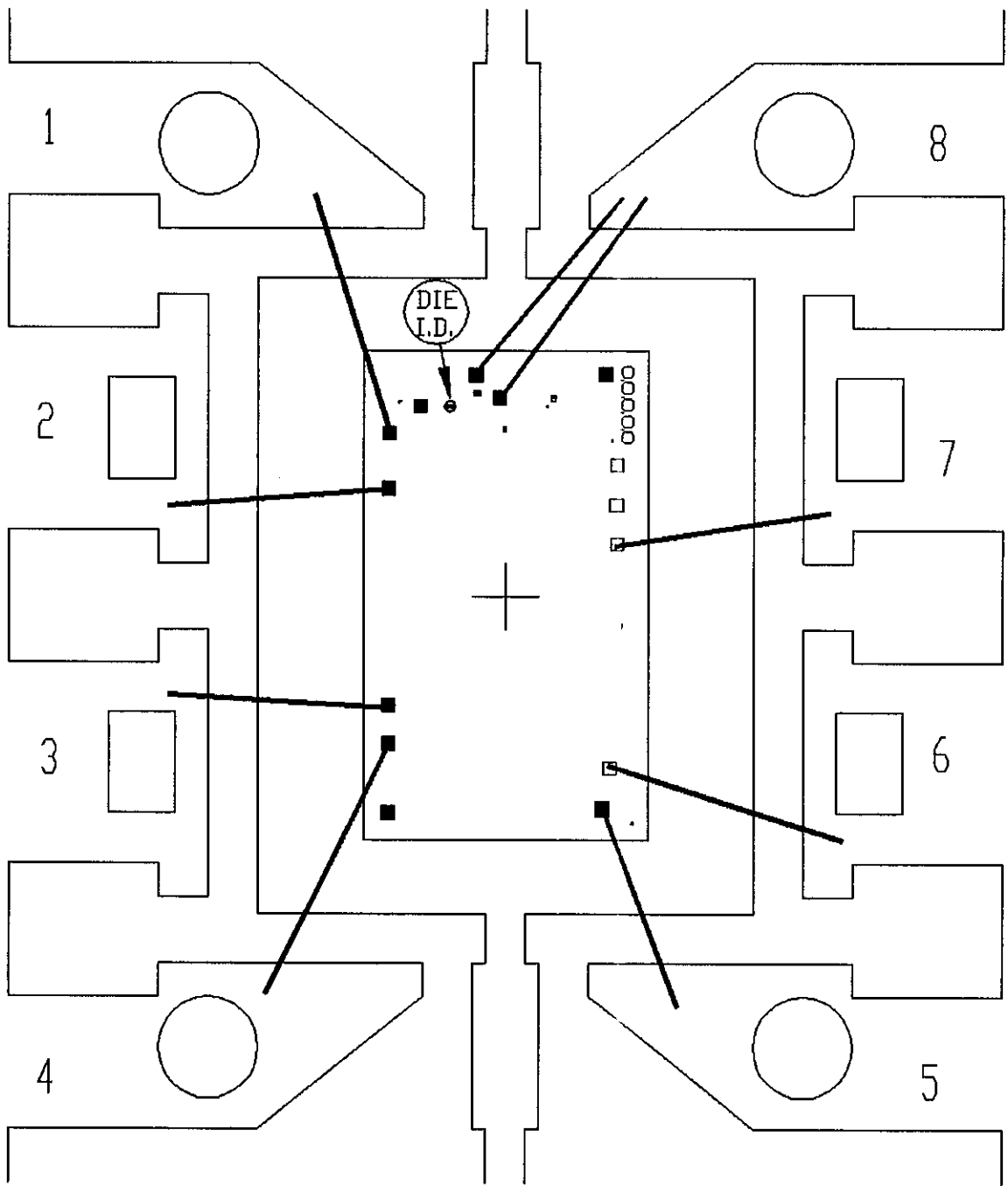

PKG.CODE: P8-3

CAV./PAD SIZE:
150 X 190

PKG.
DESIGN

APPROVALS

DATE

MAXIM

BUILDSHEET NUMBER:
05-1901-0083

REV.:
A

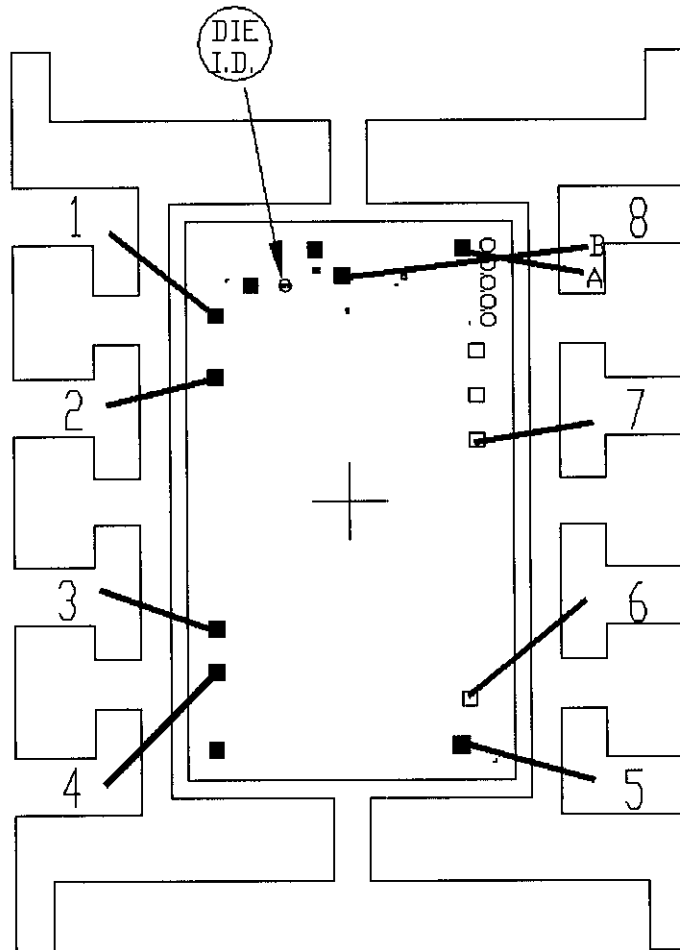

NOTE:

A. BOND A FIRST; B SECOND.

B. A & B CAN TOUCH.

PKG.CODE: S8-5		APPROVALS	DATE	MAXIM	
CAV./PAD SIZE: 95 X 155	PKG. DESIGN			BUILDSHEET NUMBER: 05-1901-0084	REV.: A

ONCE PER BOARD

ONCE PER DEVICE

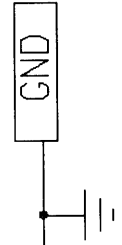
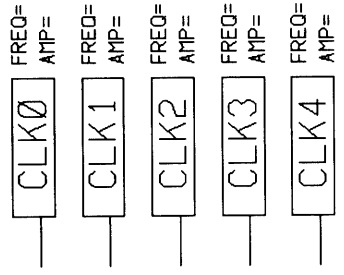
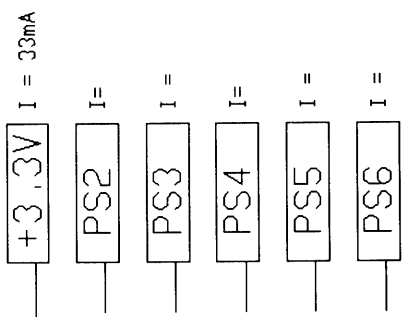
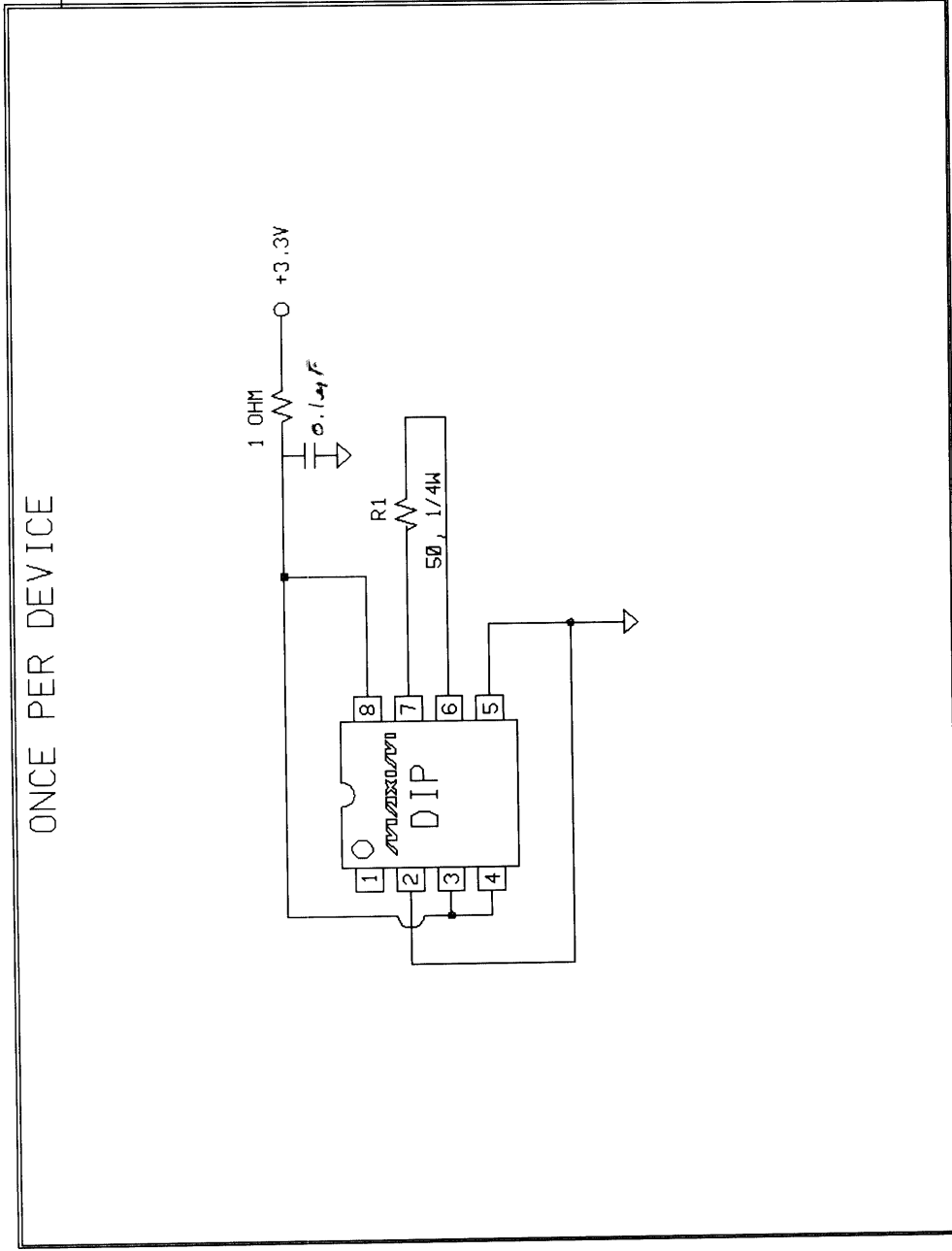

-STEADY STATE LIFE TEST IS PER MIL-STD-883 METHOD 1005.
 -BURN-IN IS PER MIL-STD-883 METHOD 1015, COND. B

MAXIM BURN-IN SCHEMATIC

SPEC. NO. 06-5082 REV: A

NOTES:

1. TEMPERATURE: 125C OR EQUIVALENT
2. TIME: 160 HOURS MIN. OR EQUIVALENT
3. ALL COMPONENTS AND MATERIAL MUST STAND 150C CONTINUOUS
4. APPROVED FOR EX1 COMMERCIAL EX1 HR/883

DEVICE TYPE(S):

MAX3483/3485/3486

DATE: 10/26/94

DRAWN BY: