

## SSM2402/SSM2412

### FEATURES

- “Clickless” Bilateral Audio Switching
- Guaranteed “Break-Before-Make” Switching
- Low Distortion: 0.003% typ
- Low Noise: 1 nV/√Hz
- Superb OFF-Isolation: 120 dB typ
- Low ON-Resistance: 60 Ω typ
- Wide Signal Range:  $V_S = \pm 18\text{ V}$ ; 10 V rms
- Wide Power Supply Range:  $\pm 20\text{ V}$  max
- Available in Dice Form

### GENERAL DESCRIPTION

The SSM2402/SSM2412 are dual analog switches designed specifically for high performance audio applications. Distortion and noise are negligible over the full audio operating range of 20 Hz to 20 kHz at signal levels of up to 10 V rms. The SSM2402/SSM2412 offer a monolithic integrated alternative to expensive and noisy relays or complex discrete JFET circuits. Unlike conventional general-purpose CMOS switches, the SSM2402/SSM2412 provide superb fidelity without audio “clicks” during switching. Conventional TTL or CMOS logic can be used to control the switch state. No external pull-up resistors are needed. A “T” configuration provides superb OFF-isolation and true bilateral operation. The analog inputs and outputs are protected against overload and overvoltage.

An important feature is the guaranteed “break-before-make” for *all* units, even IC-to-IC. In large systems with multiple switching channels, all separate switching units must open before any switch goes into the ON-state. With the SSM2402/SSM2412, you can be certain that multiple circuits will all break-before-make.

The SSM2402/SSM2412 represent a significant step forward in audio switching technology. Distortion and switching noise are significantly reduced in the new SSM2402/SSM2412 bipolar-JFET switches relative to CMOS switching technology. Based on a new circuit topology that optimizes audio performance, the SSM2402/SSM2412 make use of a proprietary bipolar-JFET process with thin-film resistor network capability. Nitride capacitors, which are very area efficient, are used for the proprietary ramp generator that controls the switch resistance transition. Very wide bandwidth amplifiers control the gate-to-source voltage over the full audio operating range for each switch. The ON-resistance remains constant with changes in signal amplitude and frequency, thus distortion is very low, less than 0.01% max.

The SSM2402 is the first analog switch truly optimized for high-performance audio applications. For broadcasting and other switching applications which require a faster switching time, we recommend the SSM2412—a dual analog switch with one-third of the switching time of the SSM2402.

### REV. A

Information furnished by Analog Devices is believed to be accurate and reliable. However, no responsibility is assumed by Analog Devices for its use, nor for any infringements of patents or other rights of third parties which may result from its use. No license is granted by implication or otherwise under any patent or patent rights of Analog Devices.

### FUNCTIONAL BLOCK DIAGRAM

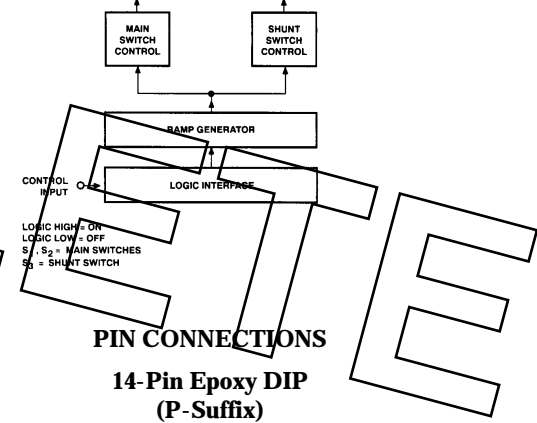
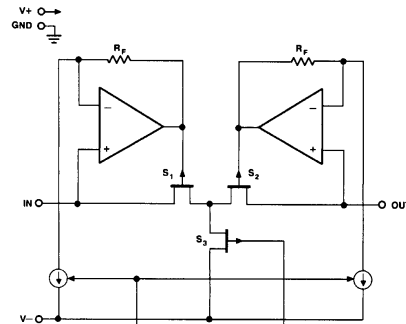

### PIN CONNECTIONS

14-Pin Epoxy DIP  
(P-Suffix)

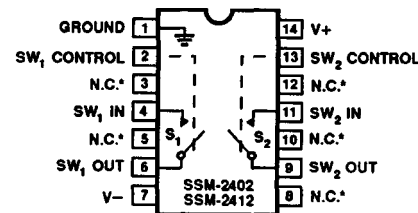

16-Pin SOL  
(S-Suffix)

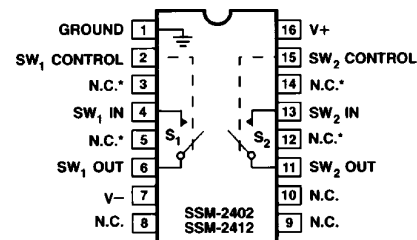

\* GUARD PINS FOR INPUT/OUTPUT ISOLATION  
(GROUND FOR BEST PERFORMANCE)

# SSM2402/SSM2412–SPECIFICATIONS

## ELECTRICAL CHARACTERISTICS (@ $V_S = \pm 18\text{ V}$ , $R_L = \text{OPEN}$ , and $-40^\circ\text{C} \leq T_A \leq +85^\circ\text{C}$ unless otherwise noted.

All specifications, tables, graphs, and application data apply to both the SSM2402 and SSM2412, unless otherwise noted.)

Parameter	Symbol	Conditions	SSM2402/SSM2412			Units
			Min	Typ	Max	
POSITIVE SUPPLY CURRENT	$+I_{SY}$	$V_{IL} = 0.8\text{ V}, 2.0\text{ V}^1$	6.0	7.5		mA
NEGATIVE SUPPLY CURRENT	$-I_{SY}$	$V_{IL} = 0.8\text{ V}, 2.0\text{ V}^1$	4.8	6.0		mA
GROUND CURRENT	$I_{GND}$	$V_{IL} = 0.8\text{ V}, 2.0\text{ V}^1$	0.6	1.5		mA
DIGITAL INPUT HIGH	$V_{INH}$	$T_A = \text{Full Temperature Range}$	20			V
DIGITAL INPUT LOW	$V_{INL}$	$T_A = \text{Full Temperature Range}$		0.8		V
LOGIC INPUT CURRENT	$I_{LOGIC}$	$V_{IN} = 0\text{ V to }15\text{ V}^2$	1.0	5.0		$\mu\text{A}$
ANALOG VOLTAGE RANGE <sup>3</sup>	$V_{ANALOG}$		-14.2		+14.2	V
ANALOG CURRENT RANGE <sup>3</sup>	$I_{ANALOG}$		-10		+10	mA
OVERVOLTAGE INPUT CURRENT		$V_{IN} = \pm V_{SUPPLY}$		$\pm 40$		mA
SWITCH ON RESISTANCE	$R_{ON}$	$-14.2\text{ V} \leq V_A \leq +14.2\text{ V}$ $I_A = \pm 10\text{ mA}, V_{IL} = 2.0\text{ V}$ $T_A = +25^\circ\text{C}$ $T_A = \text{Full Temperature Range}$ Tempco ( $\Delta R_{ON}/\Delta T$ )	60	85	115	$\Omega$ $\Omega$ $\Omega/^\circ\text{C}$
$R_{ON}$ MATCH	$R_{ON}$ MATCH	$-14.2\text{ V} \leq V_A \leq +14.2\text{ V}$ $I_A = \pm 10\text{ mA}, V_{IL} = 2.0\text{ V}$	1	5		%
SWITCH ON LEAKAGE CURRENT	$I_{S(ON)}$	$V_{IL} = 2.0\text{ V}$ $-14.2\text{ V} \leq V_A \leq +14.2\text{ V}$ $V_A = 0\text{ V}$	0.05	1.0	10.0	$\mu\text{A}$ nA
SWITCH OFF LEAKAGE CURRENT	$I_{S(OFF)}$	$V_{IL} = 0.8\text{ V}$ $-14.2\text{ V} \leq V_A \leq +14.2\text{ V}$ $V_A = 0\text{ V}$	0.05	1.0	10.0	$\mu\text{A}$ nA
TURN-ON TIME <sup>4</sup>	$t_{ON}$	$V_A = +10\text{ V}, R_L = 2\text{ k}\Omega$ $T_A = +25^\circ\text{C}$ , See Test Circuit	SSM2402 SSM2412	10.0 3.5		ms
TURN-OFF TIME <sup>5</sup>	$t_{OFF}$	$V_A = +10\text{ V}, R_L = 2\text{ k}\Omega$ $T_A = +25^\circ\text{C}$ , See Test Circuit	SSM2402 SSM2412	4.0 1.5		ms
BREAK-BEFORE-MAKE TIME DELAY <sup>6</sup>	$t_{OFF} - t_{ON}$	$T_A = +25^\circ\text{C}$	SSM2402 SSM2412	6.0 2.0		ms
CHARGE INJECTION	Q	$T_A = +25^\circ\text{C}$	SSM2402 SSM2412	50 150		pC
ON-STATE INPUT CAPACITANCE	$CS_{(ON)}$	$V_A = 1\text{ V rms}$ $f = 5\text{ kHz}, T_A = +25^\circ\text{C}$		12		pF
OFF-STATE INPUT CAPACITANCE	$CS_{(OFF)}$	$V_A = 1\text{ V rms}$ $f = 5\text{ kHz}, T_A = +25^\circ\text{C}$		4		pF
OFF ISOLATION	$I_{SO(OFF)}$	$V_A = 10\text{ V rms}, 20\text{ Hz to }20\text{ kHz}$ $T_A = +25^\circ\text{C}$ , See Test Circuit		120		dB
CHANNEL-TO-CHANNEL CROSSTALK	$C_T$	$V_A = 10\text{ V rms}, 20\text{ Hz to }20\text{ kHz}$ $T_A = +25^\circ\text{C}$		96		dB
TOTAL HARMONIC DISTORTION <sup>7</sup>	THD	$0\text{ V to }10\text{ V rms}, 20\text{ Hz to }20\text{ kHz}$ $T_A = +25^\circ\text{C}, R_L = 5\text{ k}\Omega$		0.003	0.01	%
SPECTRAL NOISE DENSITY	$e_n$	$20\text{ Hz to }20\text{ kHz}, T_A = +25^\circ\text{C}$		1		$\text{nV}/\sqrt{\text{Hz}}$
WIDEBAND NOISE DENSITY	$e_n$ p-p	$20\text{ Hz to }20\text{ kHz}, T_A = +25^\circ\text{C}$		0.2		$\mu\text{V p-p}$

### NOTES

<sup>1</sup> $V_{IL}$  is the Logic Control Input.

<sup>2</sup>Current tested at  $V_{IN} = 0\text{ V}$ . This is the worst case condition.

<sup>3</sup>Guaranteed by  $R_{ON}$  test condition.

<sup>4</sup>Turn-ON time is measured from the time the logic input reaches the 50% point to the time the output reaches 50% of the final value.

<sup>5</sup>Turn-OFF time is measured from the time the logic input reaches the 50% point to the time the output reaches 50% of the initial value.

<sup>6</sup>Switch is guaranteed by design to provide break-before-make operation.

<sup>7</sup>THD guaranteed by design and dynamic  $R_{ON}$  testing.

Specifications subject to change without notice.

# SSM2402/SSM2412

## ABSOLUTE MAXIMUM RATINGS

Operating Temperature Range .....  $-40^{\circ}\text{C}$  to  $+85^{\circ}\text{C}$   
 Operating Supply Voltage Range .....  $\pm 20\text{ V}$   
 Analog Input Voltage Range  
     Continuous .....  $V^- + 3.5\text{ V} \leq V_A \leq V^+ - 3.5\text{ V}$   
 Maximum Current Through Switch .....  $20\text{ mA}$   
 Logic Input Voltage Range .....  $V^+$  Supply to  $-2\text{ V}$   
 $V^+$  Supply to Ground .....  $+36\text{ V}$   
 $V^-$  Supply to Ground .....  $-20\text{ V}$   
 $V_A$  to  $V^-$  Supply .....  $+36\text{ V}$

Package Type	$\theta_{JA}^*$	$\theta_{JC}$	Units
14-Pin Plastic DIP (P)	76	33	$^{\circ}\text{C/W}$
16-Pin SOL (S)	92	27	$^{\circ}\text{C/W}$

\* $\theta_{JA}$  is specified for worst case mounting conditions, i.e.,  $\theta_{JA}$  is specified for device in socket for P-DIP packages;  $\theta_{JA}$  is specified for device soldered to printed circuit board for SOL package.

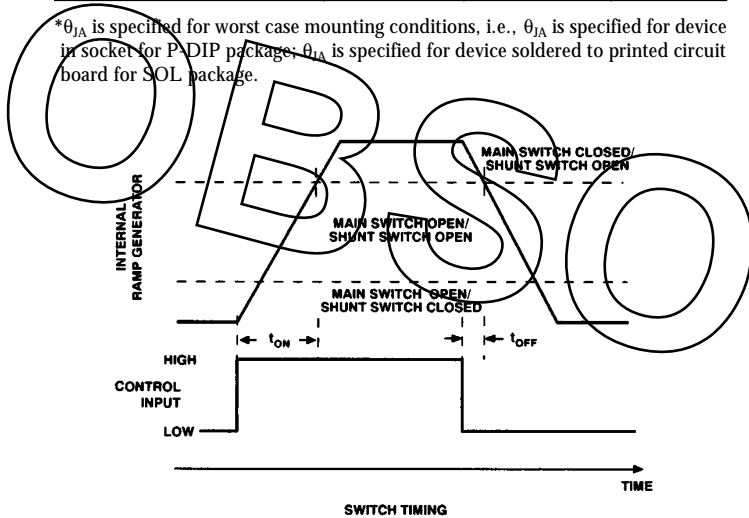

Timing Diagram

## ORDERING GUIDE

Model	Temperature Range	Package Description
SSM2402P	$-40^{\circ}\text{C}$ to $+85^{\circ}\text{C}$	14-Pin Plastic DIP
SSM2402S	$-40^{\circ}\text{C}$ to $+85^{\circ}\text{C}$	16-Pin SOL
SSM2412P	$-40^{\circ}\text{C}$ to $+85^{\circ}\text{C}$	14-Pin Plastic DIP
SSM2412S	$-40^{\circ}\text{C}$ to $+85^{\circ}\text{C}$	16-Pin SOL

## DICE CHARACTERISTICS

Die Size  $0.105 \times 0.097$  Inch, 10,185 sq. mils  
 ( $2.667 \times 2.464$  mm, 6.57 sq. mm)

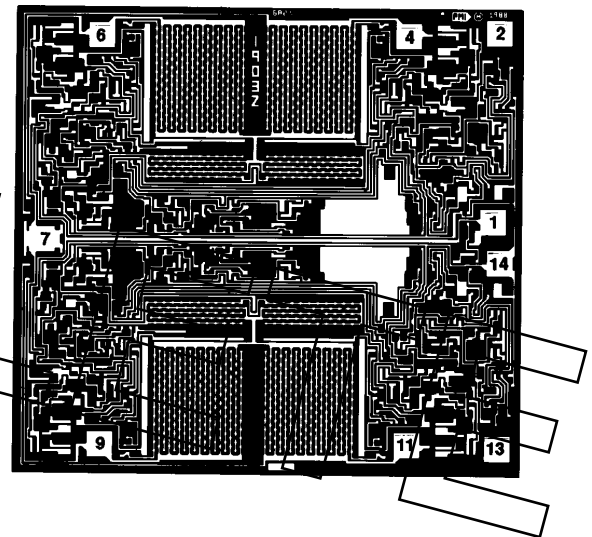

## WAFER TEST LIMITS

Parameter	Symbol	Conditions <sup>1</sup>	Limit	Units
POSITIVE SUPPLY CURRENT	$+I_{SY}$	$V_{IL} = 0.8\text{ V}$	7.5	mA max
NEGATIVE SUPPLY CURRENT	$-I_{SY}$	$V_{IL} = 0.8\text{ V}$	6.0	mA max
GROUND CURRENT	$I_{GND}$	$V_{IL} = 0.8\text{ V}$	1.5	mA max
LOGIC INPUT CURRENT	$I_{LOGIC}$	$V_{IN} = 0\text{ V}^2$	5.0	$\mu\text{A}$ max
SWITCH ON RESISTANCE	$R_{ON}$	$-14.2\text{ V} \leq V_A \leq +14.2\text{ V}$ $I_A = \pm 10\text{ mA}$ , $V_{IL} = 2.0\text{ V}$	85	$\Omega$ max
$R_{ON}$ MATCH BETWEEN SWITCHES	$R_{ON}$ MATCH	$-14.2\text{ V} \leq V_A \leq +14.2\text{ V}$ $I_A = \pm 10\text{ mA}$ , $V_{IL} = 2.0\text{ V}$	5	% max
SWITCH ON LEAKAGE CURRENT	$I_{S(ON)}$	$-14.2\text{ V} \leq V_A \leq +14.2\text{ V}$ , $V_{IL} = 2.0\text{ V}$	1.0	$\mu\text{A}$ max
SWITCH OFF LEAKAGE CURRENT	$I_{S(OFF)}$	$-14.2\text{ V} \leq V_A \leq +14.2\text{ V}$ , $V_{IL} = 0.8\text{ V}$	1.0	$\mu\text{A}$ max

### NOTES

<sup>1</sup> $V_{IL}$  = Logic Control Input;  $V_A$  = Applied Analog Input Voltage;  $I_A$  = Applied Analog Input Current.

<sup>2</sup>Worst Case Condition.

Electrical tests are performed at wafer probe to the limits shown. Due to variations in assembly methods and normal yield loss, yield after packaging is not guaranteed for standard product dice. Consult factory to negotiate specifications based on dice lot qualifications through sample lot assembly and testing.

# SSM2402/SSM2412—Typical Performance Characteristics

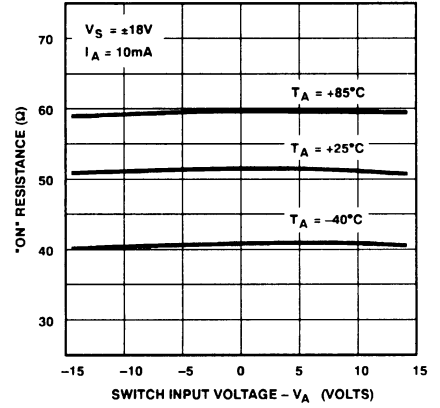
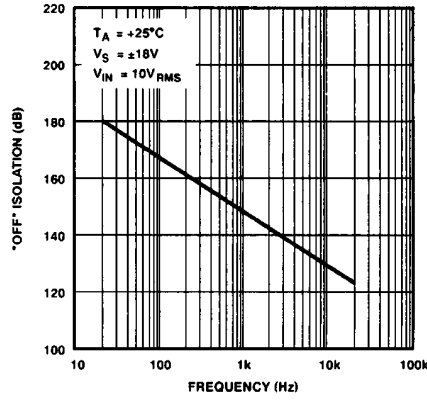
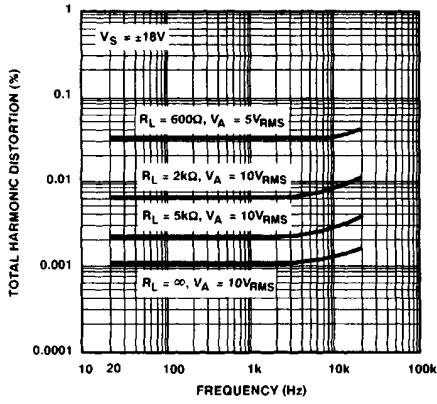

Total Harmonic Distortion vs. Frequency

"OFF" Isolation vs. Frequency

"ON" Resistance vs. Analog Voltage

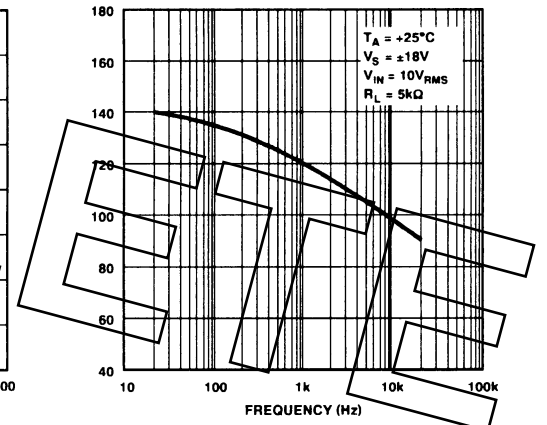
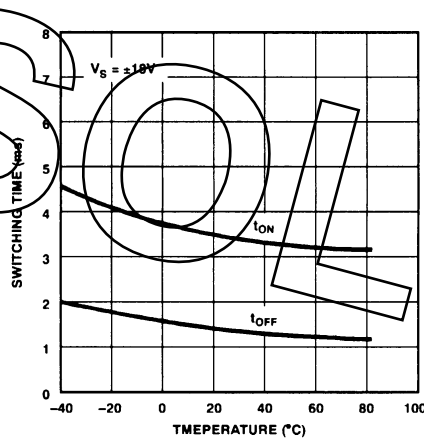
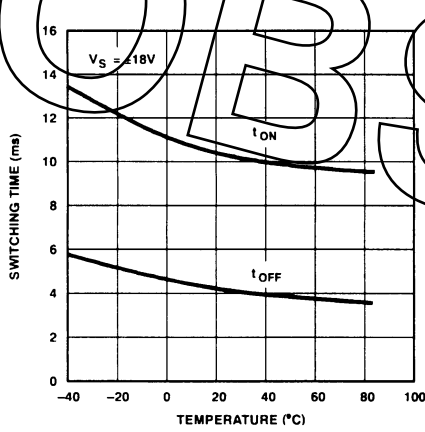

SSM2402 Switching Time vs. Temperature

SSM2412 Switching Time vs. Temperature

Channel Separation vs. Frequency

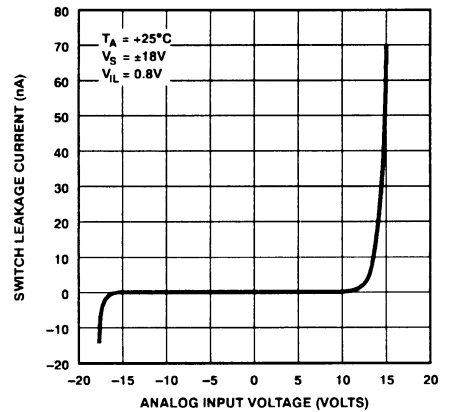
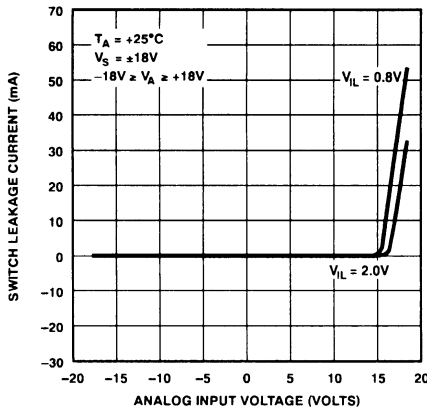
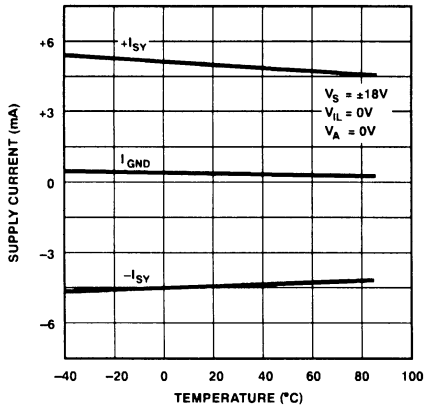

Supply Current vs. Temperature

Overvoltage Characteristics

Leakage Current vs. Analog Voltage

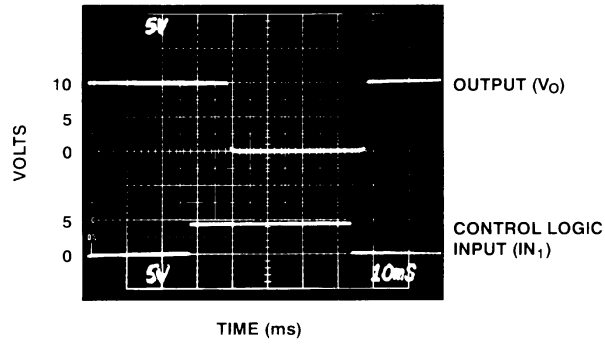

SSM2402  $T_{ON}/T_{OFF}$  Switching Response

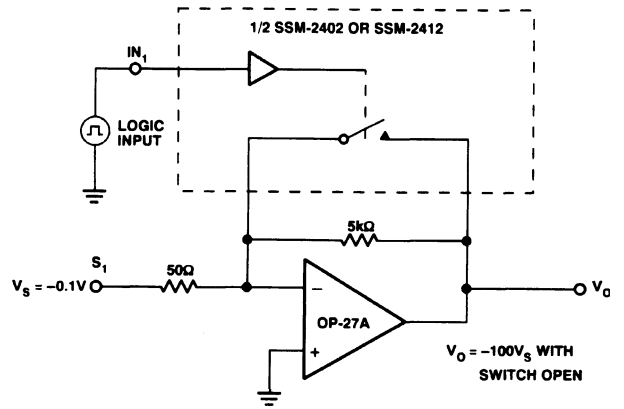

$T_{ON}/T_{OFF}$  Switching Response Test Circuit

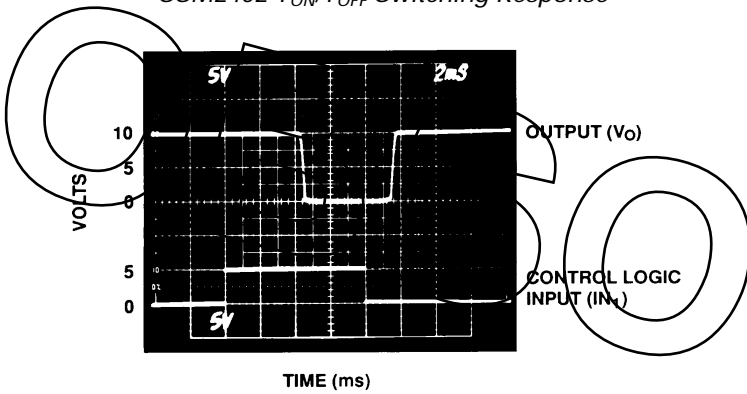

SSM 2412  $T_{ON}/T_{OFF}$  Switching Response

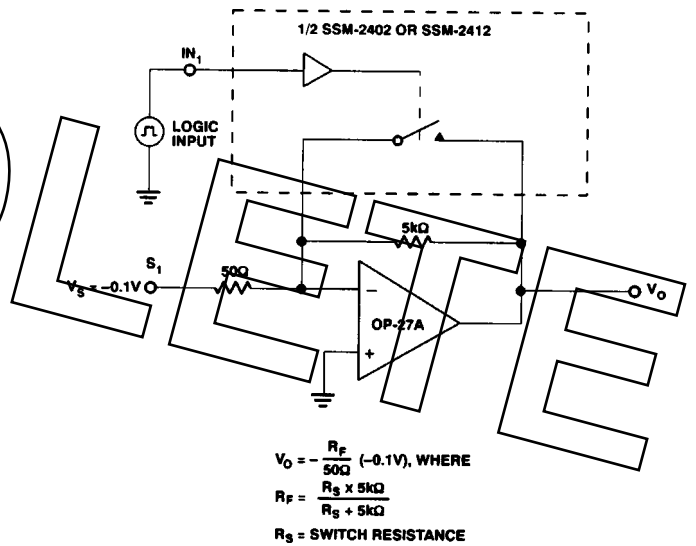

Switch ON/OFF Transition Test Circuit

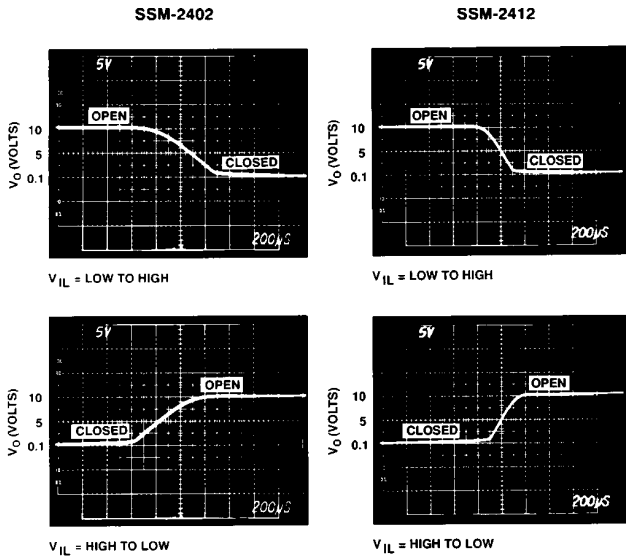

Switching ON/OFF Transition

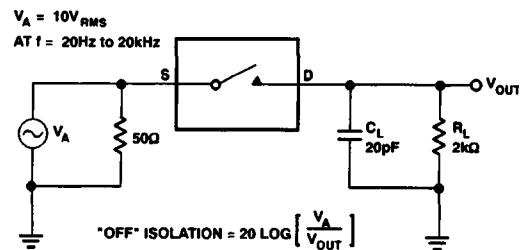

"OFF" Isolation Test Circuit

# SSM2402/SSM2412

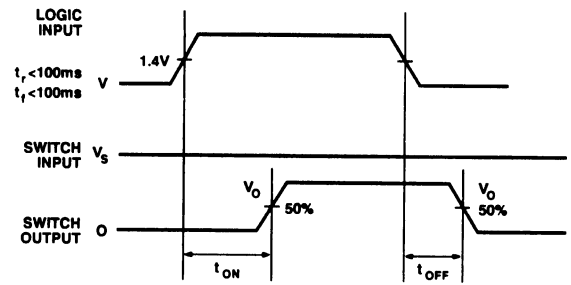
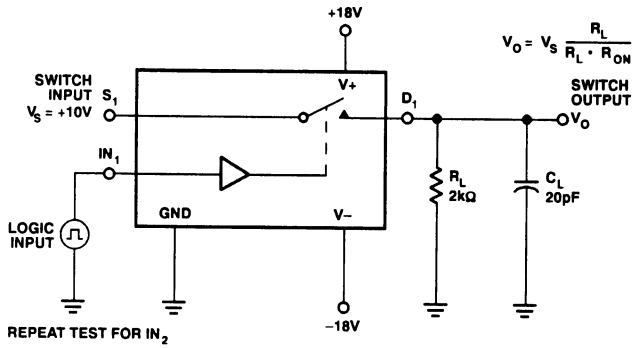

Switching Time Test Circuit

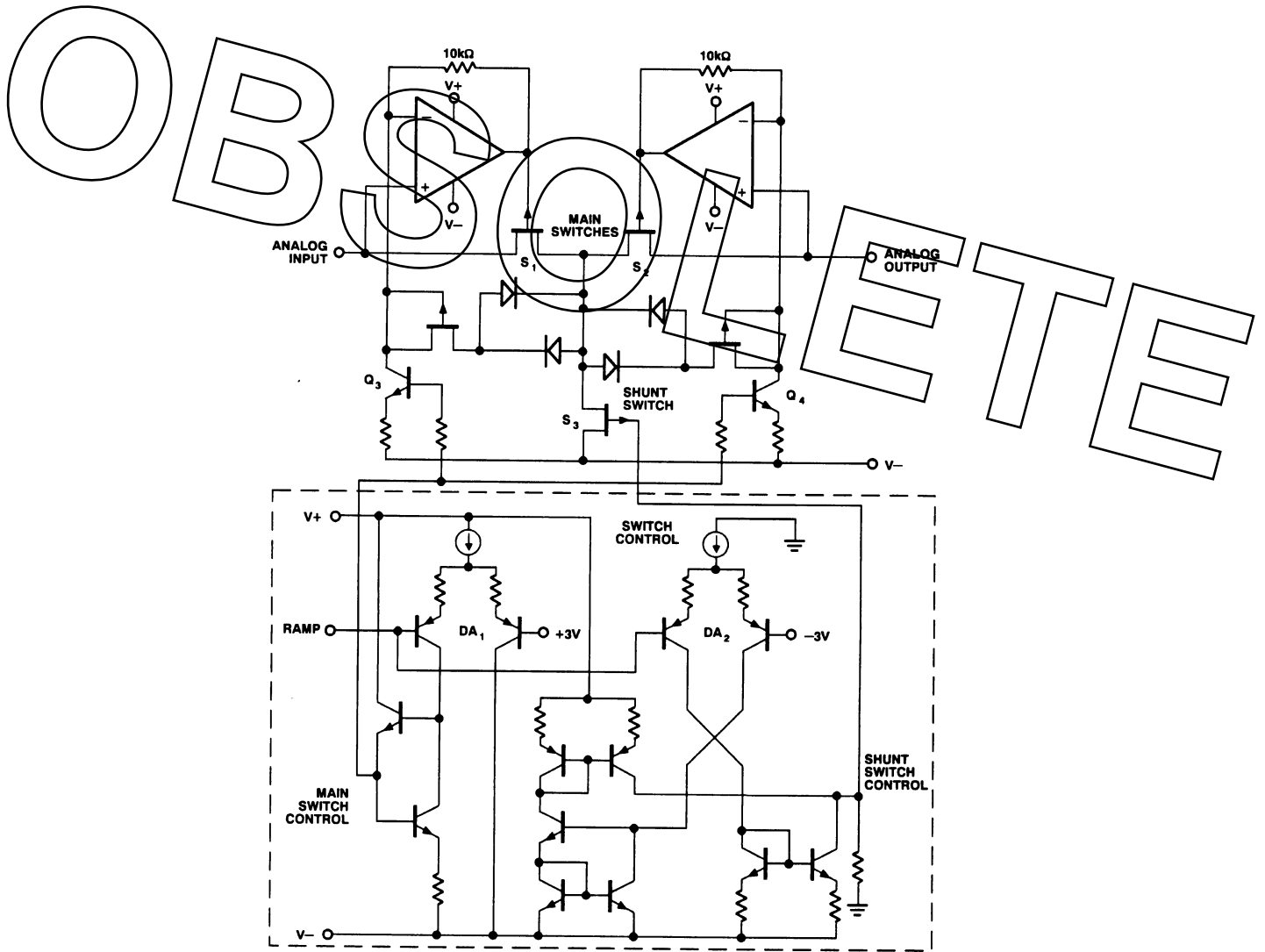

Simplified Schematic

## APPLICATIONS INFORMATION

### FUNCTIONAL SECTIONS

Each half of the SSM2402/SSM2412 are made up of three major functional blocks:

#### 1. "T" Switch

Consists of JFET switches  $S_1$  and  $S_2$  in series as the main switches and switch  $S_3$  as a shunt.

#### 2. Ramp Generator

Generates a ramp voltage on command of the Control Input (see Figure 1). A LOW-to-HIGH TTL input at Control Input initiates a ramp that goes from approximately  $-7$  V to  $+7$  V in 12 ms. Conversely, a HIGH-to-LOW TTL transition at Control Input will cause a downward ramp from approximately  $+7$  V to  $-7$  V in 12 ms for the SSM2402, and 4 ms for the SSM2412. The Ramp Generator also supplies the  $+3$  V and  $-3$  V reference levels for Switch Control.

#### 3. Switch Control

The ramp from the Ramp Generator section is applied to two differential amplifiers ( $DA_1$  and  $DA_2$ ) in the Switch Control block. (See Simplified Schematic). One amplifier is referenced to  $-3$  V and the other is referenced to  $+3$  V. Switch Control Outputs are:

- Main Switch Control**—Drives two  $0.25$  mA current sources that control the inverting inputs of each op amp. When ON, the current sources cause a gate-to-source voltage of approximately  $2.5$  V which is sufficient to turn off  $S_1$  and  $S_2$ . When the current sources from Main Switch Control are OFF, each op amp acts as a unity-gain follower ( $V_{GS} = 0$ ) and both switches ( $S_1$  and  $S_2$ ) will be ON.
- Shunt Switch Control**—Controls the Shunt Switch of the "T" configuration.

### SWITCH OPERATION

Unlike conventional analog switches, the SSM2402/SSM2412 are designed to ramp on and off gradually over several milliseconds. The soft transition prevents popping or clicking in audio systems. Transients are minimized in active filters when the SSM2402/SSM2412 are used to switch component values.

To see how the SSM2402/SSM2412 switches work, first consider an OFF-to-ON transition. The Control Input is initially LOW and the Ramp Output is at approximately  $-7$  V. The Main Switch Control is HIGH which drives current sources  $Q_3$  and  $Q_4$  to  $0.25$  mA each. These currents generate  $2.5$  V gate-to-source back bias for each JFET switch ( $S_1$  and  $S_2$ ) which holds them OFF.

The Shunt Switch Control is negative which holds the shunt JFET  $S_3$  ON. Undesired feedthrough signals in the series JFET switches  $S_1$  and  $S_2$  are shunted to the negative supply rail through  $S_3$ .

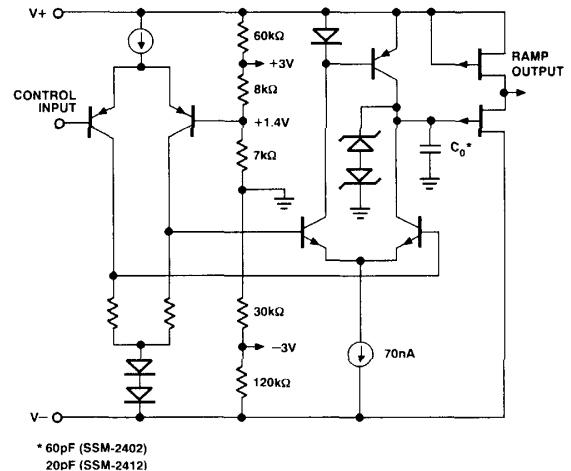

Figure 1. Ramp Generator

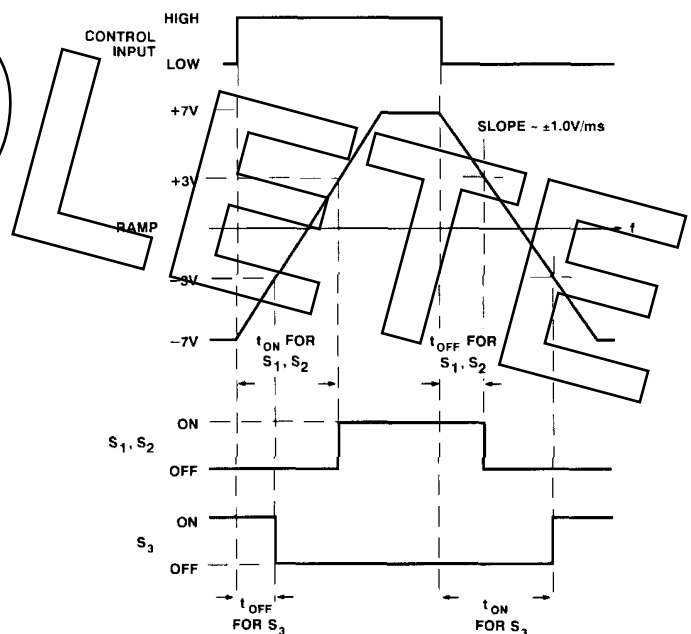

Figure 2. Switch Control

When the Control Input goes from LOW to HIGH, the Ramp Generator slews in the positive direction as shown in Figure 2. When the ramp goes more positive than  $-3$  V, the Shunt Switch Control is pulled positive by differential amplifier  $DA_2$  which thereby puts shunt switch  $S_3$  into the OFF state. Note that  $S_1$  and  $S_2$  are still OFF, so at this time all three switches in the "T" are OFF.

# SSM2402/SSM2412

When the Ramp Output reaches +3 V, and the drive for the Main Switch Control output is gated OFF by differential amplifier DA<sub>1</sub>, current sources Q<sub>3</sub> and Q<sub>4</sub> go to the OFF state and the V<sub>GS</sub> of each main switch goes to zero. The high speed op amp followers provide essentially zero gate-to-source voltage over the full audio signal range; this in turn assures a constant low impedance in the ON state over the full audio signal range. Total time to turn on the SSM2402 switch is approximately 10.0 ms and 3.5 ms for the SSM2412.

In systems using a large number of separate switches, there are advantages to having faster switching into OFF state than into the ON state. Break-before-make can be maintained at the system level. To see how the SSM2402/SSM2412 guarantee break-before-make, consider the ON-to-OFF transition.

A Control Input LOW initiates the ON-to-OFF transition. The Ramp Generator integrates down from approximately +7 V towards -7 V. As the ramp goes through +3 V, the comparator controlling the Main Switches (S<sub>1</sub> and S<sub>2</sub>) goes HIGH and turns on current sources Q<sub>3</sub> and Q<sub>4</sub> which thereby puts S<sub>1</sub> and S<sub>2</sub> into the OFF state. At this time, all switches in the "T" are OFF. When the ramp integrates down to -3 V, the Shunt Switch Control changes state and pulls shunt switch S<sub>3</sub> into the ON state. This completes the ON-to-OFF transition; S<sub>1</sub> and S<sub>2</sub> are OFF, and S<sub>3</sub> is ON to shunt away any undesired feedthrough. Note though that the ON-to-OFF time for main switches S<sub>1</sub> and S<sub>2</sub> is only the time interval required for the ramp to go from +7 V to +3 V, about 4 ms for the SSM2402, and 1.5 ms for the SSM2412. The time to turn on is about 2.5 times as long as the time to turn off.

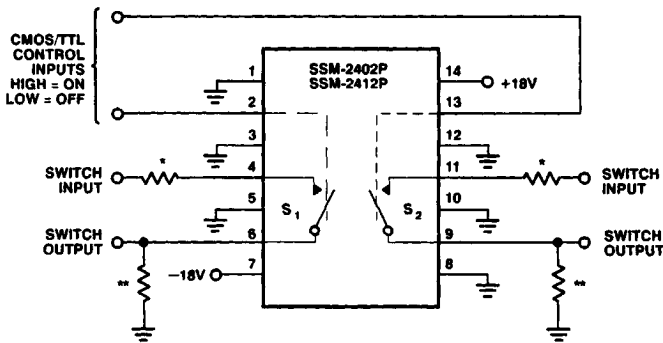

- \* OPTIONAL INPUT RESISTORS  
SEE SECTION ON OVERVOLTAGE PROTECTION
- \*\* OPTIONAL LOAD RESISTORS  
LOWER VALUES WILL MINIMIZE "CLICKS" BUT WITH A 10V<sub>RMS</sub> INPUT  
IT IS RECOMMENDED THAT THEY BE GREATER THAN 2kΩ

### Typical Configuration

The SSM2402/SSM2412 are much more than simple single solid state switches. The "T" configuration provides superb OFF-isolation through shunting of feedthrough via shunt switch S<sub>3</sub>. Break-before-make is inherent in the design. The ramp provides a controlled gating action that softens the ON/OFF transitions. Distortion is minimized by holding zero gate-to-source voltage for the two main FET switches, S<sub>1</sub> and S<sub>2</sub>, using the two op amp followers. Figure 3 shows a distortion comparison between the SSM2402 and a typical CMOS switch. In summary, the SSM2402/SSM2412 are designed specifically for high performance audio system usage.

### OVERVOLTAGE PROTECTION

The SSM2402/SSM2412 are designed to guarantee correct operation with inputs of up to ±14.2 V with ±18 V supplies. The switch input should never be forced to go beyond the supply rails. In the OFF condition, if the inputs exceeds +14.2 V, there is a risk of turning the respective input pass FET "ON." When the input voltage rises to within 3.8 V of the positive supply, the op amp follower saturates and will not be able to maintain the full 2.5 V of back bias on the gate-to-source junction. Under this condition, current will flow from the input through the shunt FET to the negative supply. This current is substantial, but is limited by the FET I<sub>DSS</sub>. Although this current will not damage the device, there is a danger of also turning on the output pass FET, especially if the output is close to the negative rail.

This risk of signal "breakthrough" for inputs above +14.2 V can be eliminated by using a source resistor of 100 Ω–500 Ω in series with the analog input to provide additional current limiting.

Near the negative supply, transistors Q<sub>3</sub> and Q<sub>4</sub> saturate and can no longer keep the switch OFF. Signal breakthrough cannot happen, but the danger here is latch-up via a path to V- through the shunt FET. Additional circuitry (not shown) has been incorporated to turn OFF the shunt FET under these conditions, and the potential for latch-up is thereby eliminated.

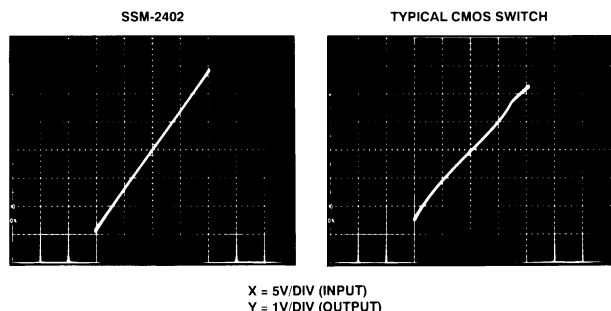
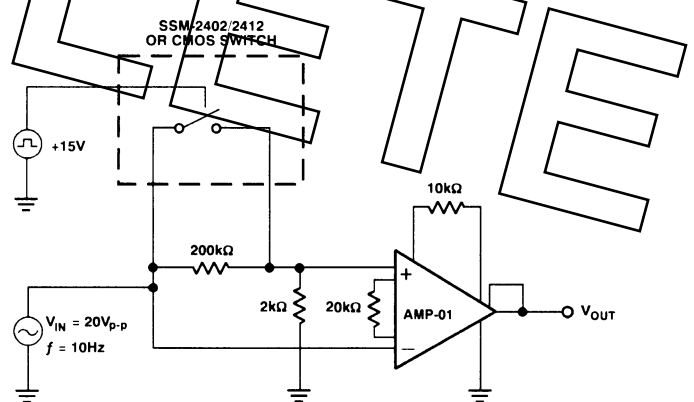

Figure 3. Comparison of the SSM2402 and Typical CMOS Switch for Distortion



**DIGITALLY-CONTROLLED ATTENUATOR**

Figure 4 shows the usual approach to digitally-controlled attenuation. With  $S_1$  closed, the signal passes unattenuated to the output. With  $S_1$  open and  $S_2$  closed, the signal is attenuated by  $R_1$  and  $R_2$ . The advantage of this configuration is that the attenuator current does not have to flow through the switches. The disadvantage is that the output is undefined during the switching period, which can be several milliseconds.

The low distortion characteristics of the SSM2402/SSM2412 enable the alternate arrangement of Figure 5 to be used. Now only one switch is required to change between two gains, and there is always a signal path to the output. Values for  $R_2$  will typically be in the low kilohm range.

For more gain steps and higher attenuation, the ladder arrangement of Figure 6 can be used. This enables a wide dynamic range to be achieved without the need for large value resistors, which would result in degradation of the noise performance.

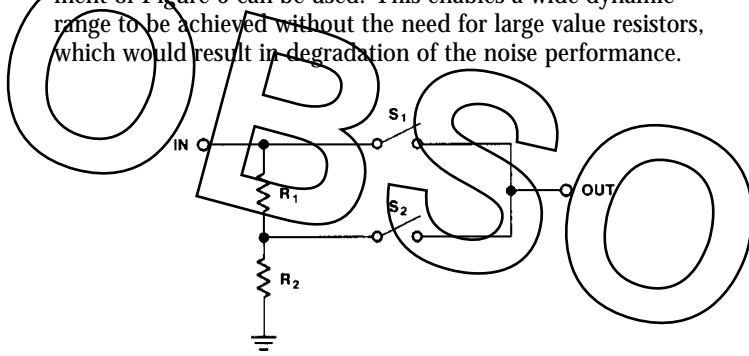

Figure 4.

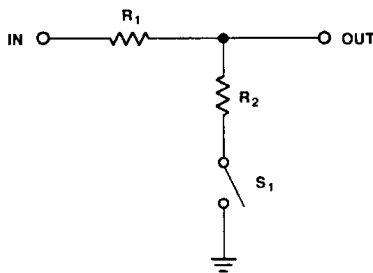

Figure 5.

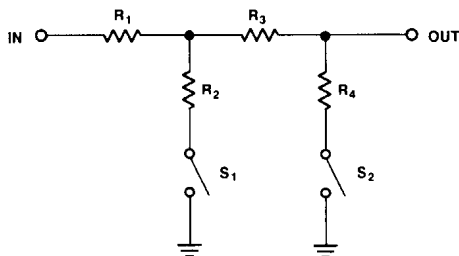

Figure 6.

**HIGH PERFORMANCE STEREO ROUTING SWITCHER**

The SSM2402 Dual Audio Switch comprises the nucleus for this 16 channels-to-one high performance stereo audio routing switcher, which features negligible noise and low distortion over the frequency range of 20 Hz to 20 kHz. This performance is achieved even while driving 600  $\Omega$  loads at signal levels up to +30 dBu.

The SSM2402 affords a much simplified electrical design and printed circuit board layout, along with reduced manufacturing cost, when compared with discrete JFET circuits of similar performance. The electrical performance of the design described is vastly superior to CMOS switch designs, which are more prone to failure resulting from electrical static discharge.

The switching control of the SSM2402 may be activated by conventional mechanical switches or 5 volt TTL or CMOS logic circuits. The application shown utilizes a simple mechanical control switch for illustration purposes only. Many diverse X/Y control schemes, destination control, or computer controlled designs can be utilized.

The "T" configuration of the SSM2402 switch provides excellent ON-OFF isolation. The SSM2402 also features ms ramped turn on and ms ramped turn off for click-free switching. Additionally, the switch has a break-before-make switching sequence. Both features become significant in large audio switching systems where the audio path can pass through multiple switching elements. Such controlled switching is very important in large systems used in broadcast program switching or in production work.

The application circuit design also employs the SSM2015 balanced input amplifier (Figure 7). The input impedance is high ( $\approx 100$  k $\Omega$ ), balanced or unbalanced. The input circuit incorporates a single pole RFI filter with a cutoff frequency set at 145 kHz. In addition, the input circuit attenuates the signal by  $\pm 25$  dB and extends the common-mode input voltage range to  $\pm 98$  volts peak, with common-mode rejection greater than 70 dB from 20 Hz to 20 kHz. The SSM2015 is set to produce a 15 dB gain. The signal drive level into the SSM2402 switch is then +10 dBu with a +20 dBu input level and +14 dBu peak, well within ideal operating range. Good signal-to-noise is maintained, with generous head-room available by electing to use  $\pm 18$  V dc power supply voltages.

# SSM2402/SSM2412

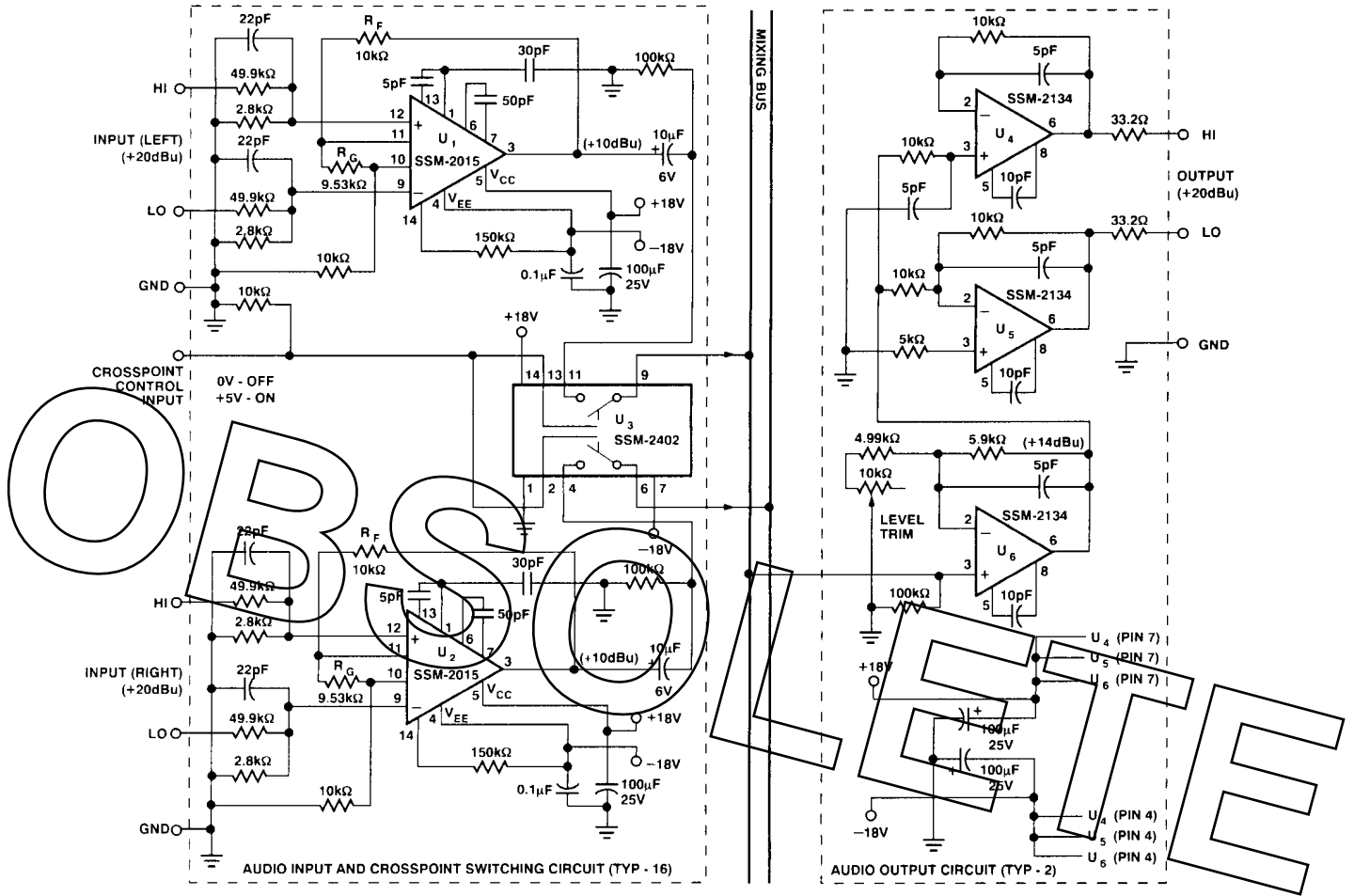

Figure 7. Switcher Schematic

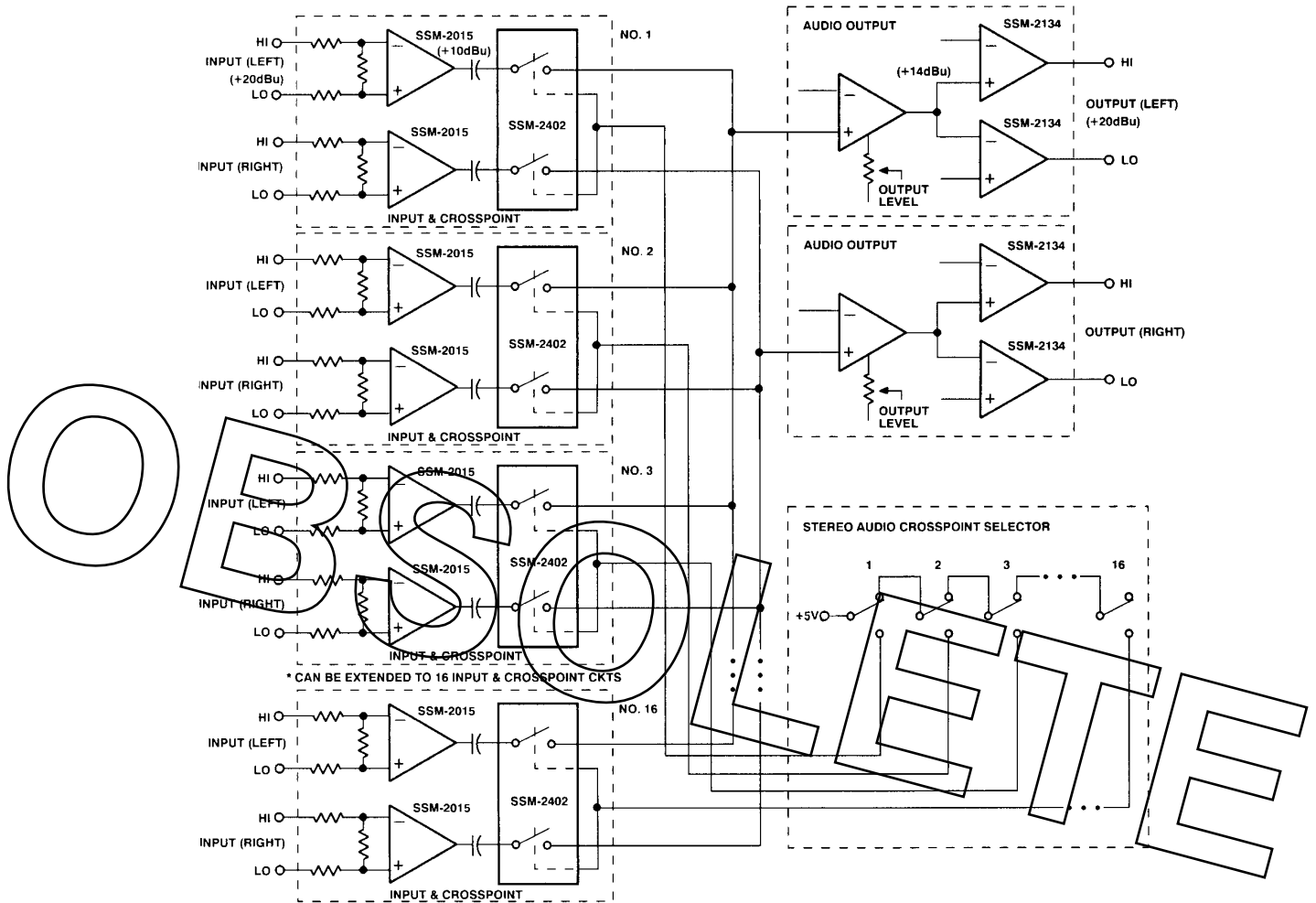

Figure 8. Switcher Functional Block Diagram

The routing switcher bus carries high level unbalanced audio, but is driven with low impedance sources. With the output impedance of the SSM2015 at virtually  $0\ \Omega$  and the SSM2402 switch ON, resistance is typically  $60\ \Omega$ . Bus-to-bus crosstalk is exceptionally low. For example, assuming  $14\ \text{pF}$  coupling between buses and  $20\ \text{kHz}$  signal, the crosstalk (isolation) exceeds  $80\ \text{dB}$ . The  $14\ \text{pF}$  would be representative for the  $16 \times 1$  stereo design shown. Shielding of the buses with a printed circuit board ground plane and physically isolating the input and output circuits will reduce the crosstalk even further. The “T” configuration of the SSM2402 switch virtually eliminates crosstalk between the various input signal sources.

The output amplifier incorporates a buffer amplifier that provides  $4\ \text{dB}$  of gain (nominally), with adjustable output level trim control. The buffer also isolates the switching bus from the balanced output amplifier circuit. The balanced output is designed to drive  $600\ \Omega$  loads and utilizes two SSM2134 IC amplifiers. The differential design increases drive capability, yet increases the heat dissipation surface area, and keeps IC package temperature well within safe operating limits, even when driving  $600\ \Omega$  loads. The SSM2134 is recommended due to its low noise, wide frequency response, and output drive current capabilities.

Overall performance of the  $16 \times 1$  stereo switcher is noteworthy. Input-to-output frequency response is flat to within  $1\ \text{dB}$  over a  $10\ \text{Hz}$  to  $50\ \text{kHz}$  band. Total harmonic distortion plus noise is less than  $0.03\%$ , from  $20\ \text{Hz}$  to  $20\ \text{kHz}$ . SMPTE intermodulation distortion is less than  $0.02\%$ . The use of  $\pm 18\ \text{V}$  dc power supplies produces a  $+30\ \text{dBm}$  clip level, even when driving  $600\ \Omega$  loads.

Table I. Circuit Performance Specifications

Max Input Level	+30 dBu
Input Impedance, Unbalanced	100 k $\Omega$
Input Impedance, Balanced	200 k $\Omega$
Common-Mode Rejection (20 Hz to 20 kHz)	>70 dB
Common-Mode Voltage Limit	$\pm 98\ \text{V}$ Peak
Max Output Level	+30 dBu/dBm
Output Impedance	67 $\Omega$
Gain Control Range	$\pm 2\ \text{dB}$
Output Voltage Slew Rate	6 V/ $\mu\text{s}$
Frequency Response ( $\pm 0.05\ \text{dB}$ )	20 Hz to 20 kHz
Frequency Response ( $\pm 0.5\ \text{dB}$ )	10 Hz to 50 kHz
THD + Noise (20 Hz to 20 kHz, +8 dBu)	0.005%
THD + Noise (20 Hz to 20 kHz, +24 dBu)	0.03%
IMD (SMPTE 60 Hz & 4 kHz, 4:1, +24 dBu)	0.02%
Crosstalk (20 Hz to 20 kHz)	>80 dB
S/N Ratio @ 0 dB Gain	135 dB

**OUTLINE DIMENSIONS**

Dimensions shown in inches and (mm).

**14-Pin Epoxy DIP  
(P-Suffix)**

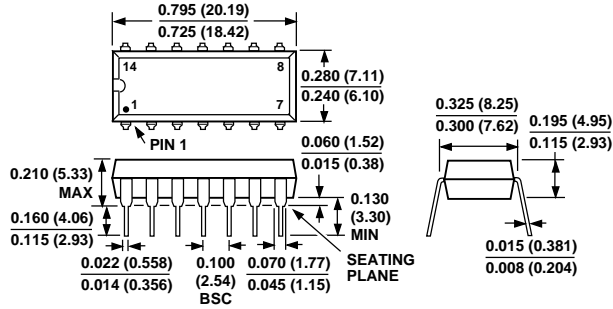

**16-Pin SOL  
(S-Suffix)**

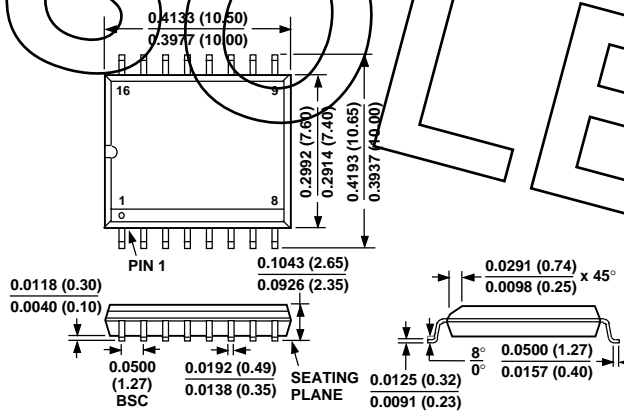

OBSOLETE