

SHEET: OF	SCALE:	DRAWN:	DATED:
SIZE:	DRAWING NO:	REV:	CODE:
EVAL-ADuC8xxQS		B	
CHECKED:		DATED: July 2002	
QUALITY CONTROL:		DATED:	
RELEASED:		DATED:	

TITLE:  
**EVAL-ADuC8xxQS Schematic**

COMPANY:  
**Analog Devices Inc.**

ANALOG I/O

ANALOG CIRCUITRY

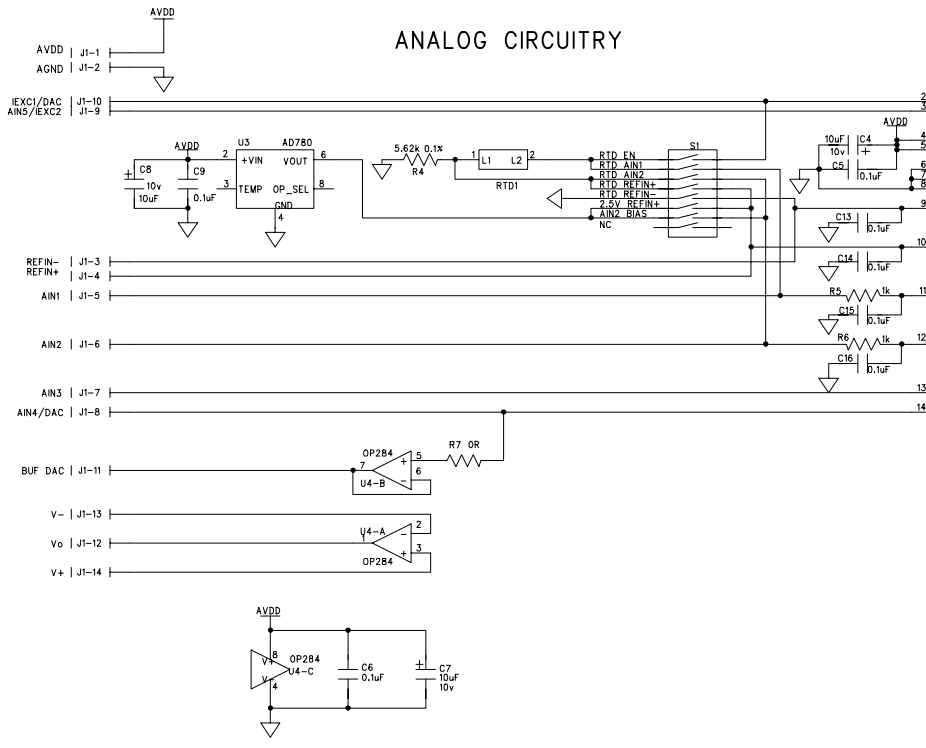

POWER

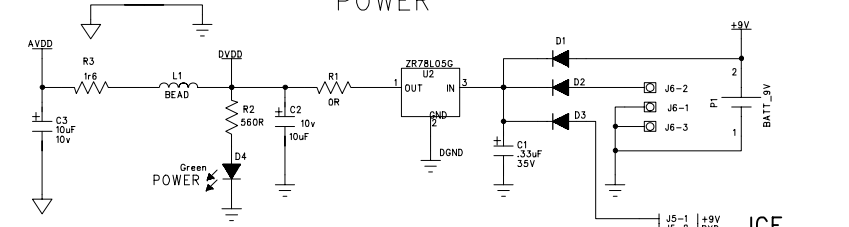

ICE HEADER  
RS232 HEADER  
STROBES

SPI/I2C

DIGITAL PORT PINS

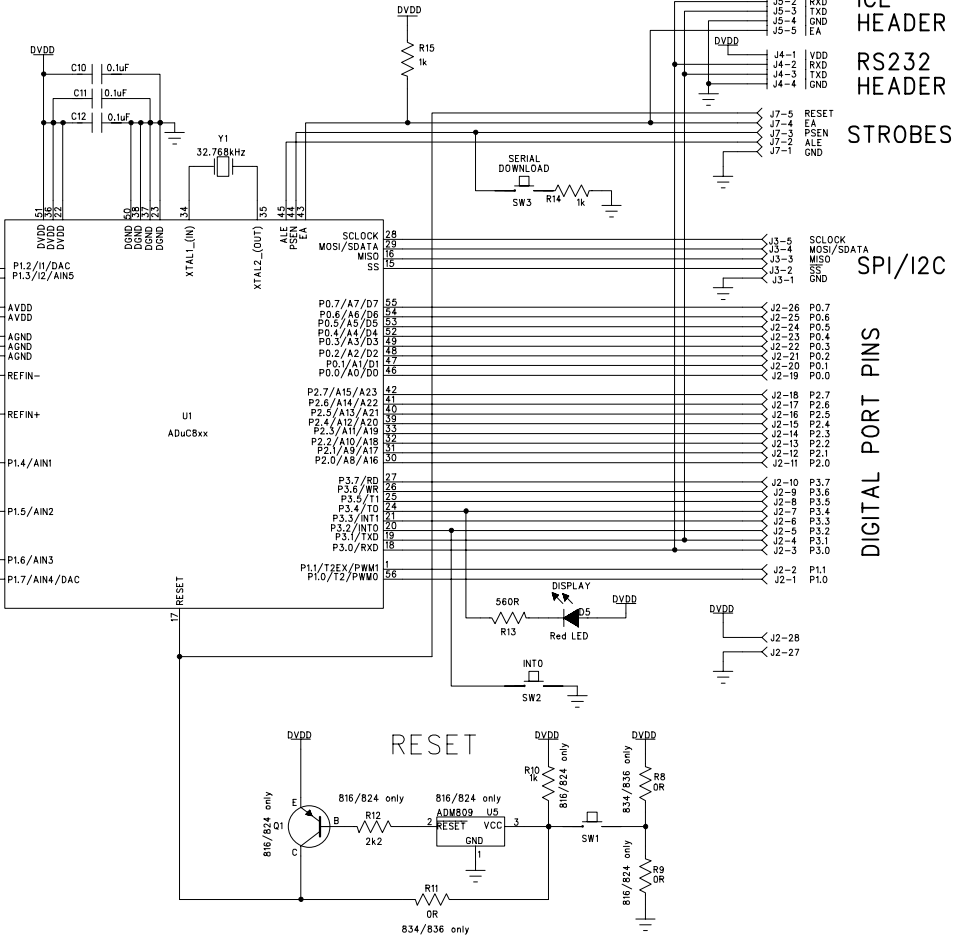

RESET

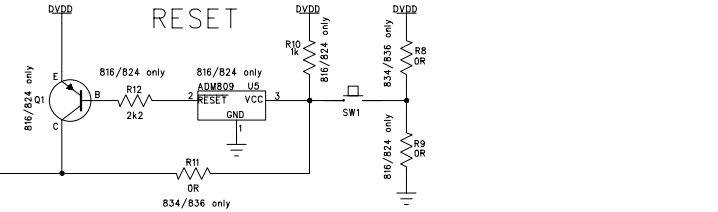

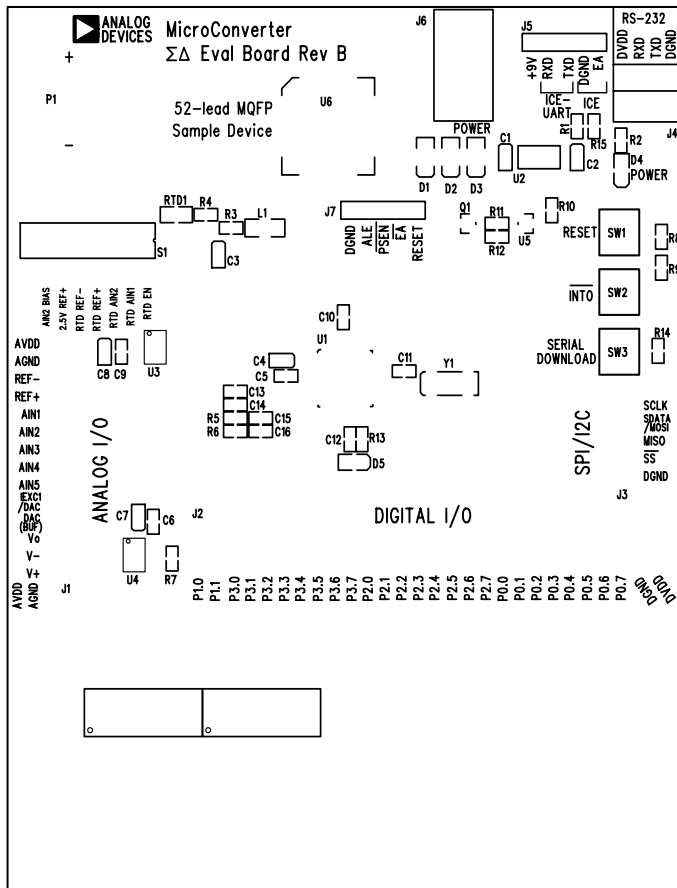
SD Eval-ADuC8xxQS Eval Board rev. B- Component Side View

Silkscreen Top

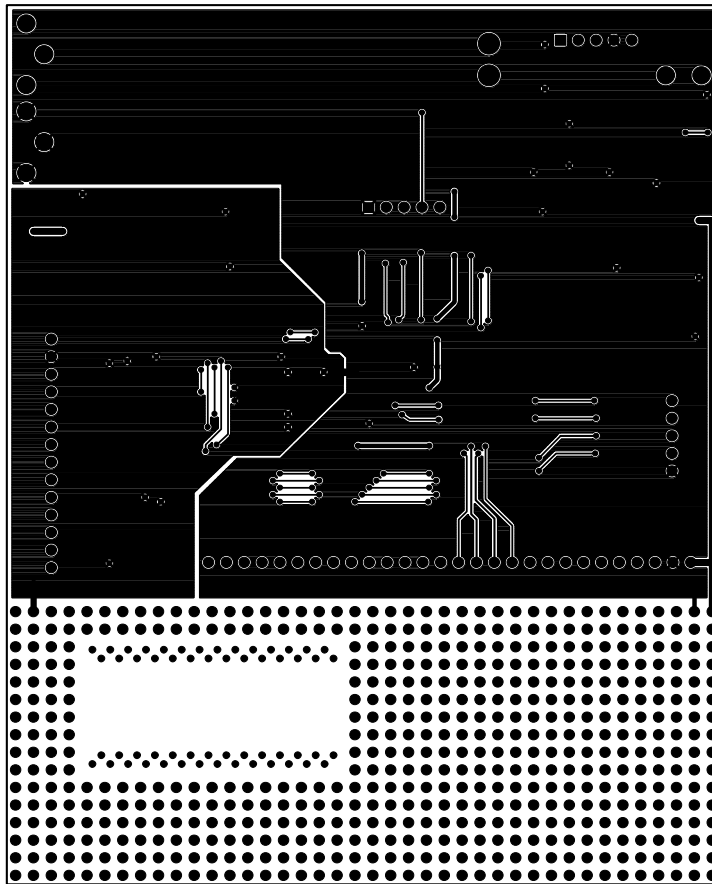

SD Eval-ADuC8xxQS Eval Board rev. B- Component Side View

Solder Side

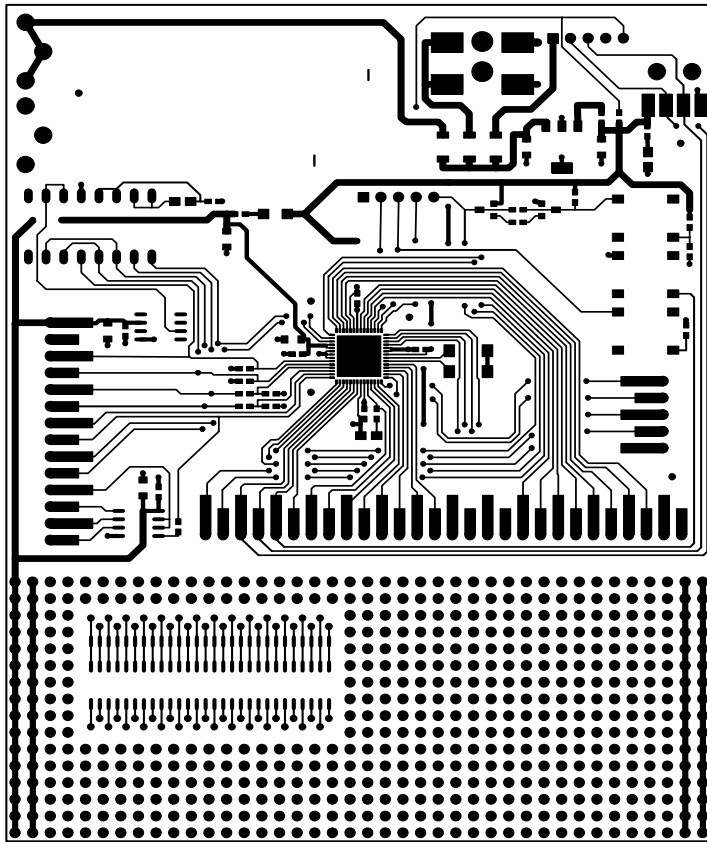

SD Eval-ADuC8xxQS Eval Board rev. B- Component Side View

Component Side