

JUMPER LEGEND

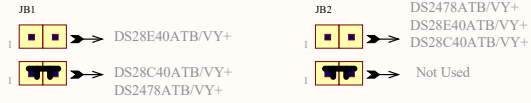

TDFN Socket Supports:

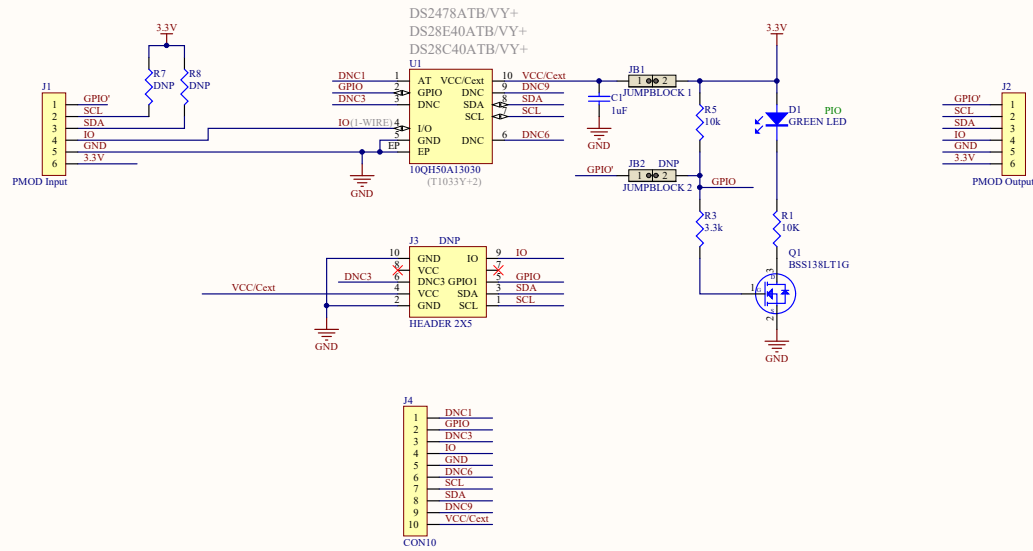

CHIPS SHOWN ARE FOR REFERENCE ONLY

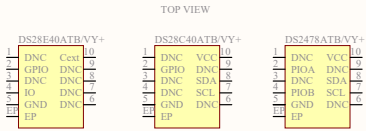

Copyright © 2020 Maxim Integrated		Cannot open file C:\Users\peter.cook\Pictures\Work\Logos\Maxim\Logo	
Title: DS9121ATB+ 3x3mm Socket Board (10 TDFN)			
Size: J1x17	Document Number:	Rev: A	
Date: 11/03/2020	Drawn By: gsm	Sheet 1 of 1	

TOP ASSEMBLY

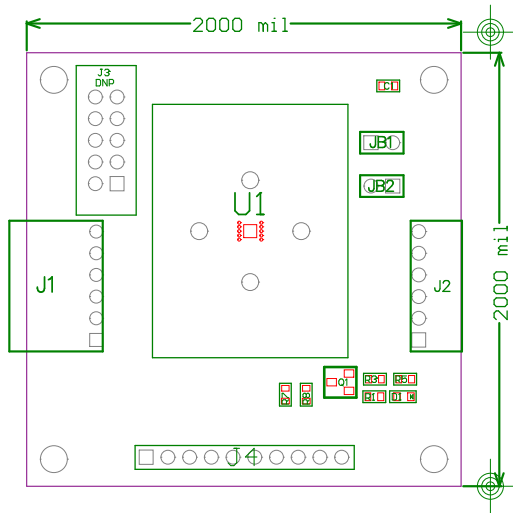

DS9121ATB	
Part Number: ???	
Property of	Rev
maxim integrated™	A
Drill and Mechanical Layer	
Date: NOV 17 2020 Units in mils	

SIZE	QTY	SYM	PLATED	TOLERANCE
12	15		YES	+/- 0.003
39	1		NO	+/- 0.003
39	36		YES	+/- 0.003
47	1		NO	+/- 0.003
67	4		YES	+/- 0.003
125	4		NO	+/- 0.003

Notes:

1. Large soldermask void is normal and necessary under U1 socket
2. Material: RoHS Compliant FR-4 or similar laminate material
3. Board Dimensions: (2000 x 2000 mils)
4. Board Thickness: 62 mils +/- 10%
5. Layers: 2 (Top, Bottom)
6. Minimum Trace/Spacing: 10 trace - 6 space
7. Copper Thickness: 1oz on all layers
8. Surface mount pads: 28 Through Hole Pads: 36 Nonplated through holes: 6 plated mounting holes: 4
9. Soldermask: GREEN
10. Legend: White. top side only
11. Plating: ENIG
12. Finish: Most Economical Lead free and RoHS compliant process
13. Vendor Logo & date code: Allowed on bottom side only
14. Total Drill hole quantity: 61 Slot Holes: 0 Smallest hole size: 12mil
15. Tolerances:
 - Plated-through holes +/- 3 mil
 - Pattern to pattern +/- 6 mil
 - Legend to legend no preference
 - Soldermask to pattern +/- 6 mil
16. Electrical testing needed: YES

62mil PCB

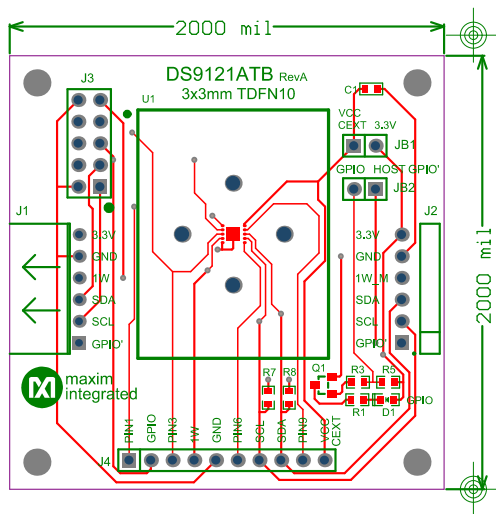

DS9121ATB	
Part Number: ???	
Property of	Rev
maxim integrated™	A
Drill and Mechanical Layer	
Date: NOV 17 2020 Units in mils	

SIZE	QTY	SYM	PLATED	TOLERANCE
12	15	-	YES	+/- 0.003
39	1		NO	+/- 0.003
39	36		YES	+/- 0.003
47	1		NO	+/- 0.003
67	4		YES	+/- 0.003
125	4		NO	+/- 0.003

Notes:

1. Large soldermask void is normal and necessary under U1 socket
2. Material: RoHS Compliant FR-4 or similar laminate material
3. Board Dimensions: (2000 x 2000 mils)
4. Board Thickness: 62 mils +/- 10%
5. Layers: 2 (Top, Bottom)
6. Minimum Trace/Spacing: 10 trace - 6 space
7. Copper Thickness: 1oz on all layers
8. Surface mount pads: 28 Through Hole Pads: 36 Nonplated through holes: 6 plated mounting holes: 4
9. Soldermask: GREEN
10. Legend: White. top side only
11. Plating: ENIG
12. Finish: Most Economical Lead free and RoHS compliant process
13. Vendor Logo & date code: Allowed on bottom side only
14. Total Drill hole quantity: 61 Slot Holes: 0 Smallest hole size: 12mil
15. Tolerances:
 - Plated-through holes +/- 3 mil
 - Pattern to pattern +/- 6 mil
 - Legend to legend no preference
 - Soldermask to pattern +/- 6 mil
16. Electrical testing needed: YES

Top Silk Screen

TOP METAL

62mil PCB

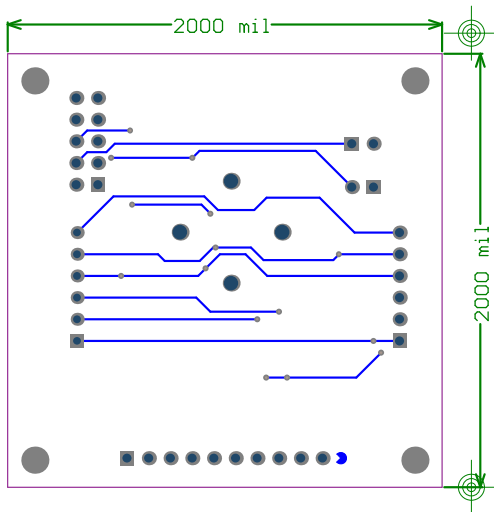

DS9121ATB	
Part Number: ???	
Property of	Rev
maxim integrated™	A
Drill and Mechanical Layer	
Date: NOV 17 2020 Units in mils	

SIZE	QTY	SYM	PLATED	TOLERANCE
12	15	-	YES	+/- 0.003
39	1		NO	+/- 0.003
39	36		YES	+/- 0.003
47	1		NO	+/- 0.003
67	4		YES	+/- 0.003
125	4		NO	+/- 0.003

Notes:

1. Large soldermask void is normal and necessary under U1 socket
2. Material: RoHS Compliant FR-4 or similar laminate material
3. Board Dimensions: (2000 x 2000 mils)
4. Board Thickness: 62 mils +/- 10%
5. Layers: 2 (Top, Bottom)
6. Minimum Trace/Spacing: 10 trace - 6 space
7. Copper Thickness: 1oz on all layers
8. Surface mount pads: 28 Through Hole Pads: 36 Nonplated through holes: 6 plated mounting holes: 4
9. Soldermask: GREEN
10. Legend: White, top side only
11. Plating: ENIG
12. Finish: Most Economical Lead free and RoHS compliant process
13. Vendor Logo & date code: Allowed on bottom side only
14. Total Drill hole quantity: 61 Slot Holes: 0 Smallest hole size: 12mil
15. Tolerances:
 - Plated-through holes +/- 3 mil
 - Pattern to pattern +/- 6 mil
 - Legend to legend no preference
 - Soldermask to pattern +/- 6 mil
16. Electrical testing needed: YES

62mil PCB

Bottom Metal

IsTeM mottoB

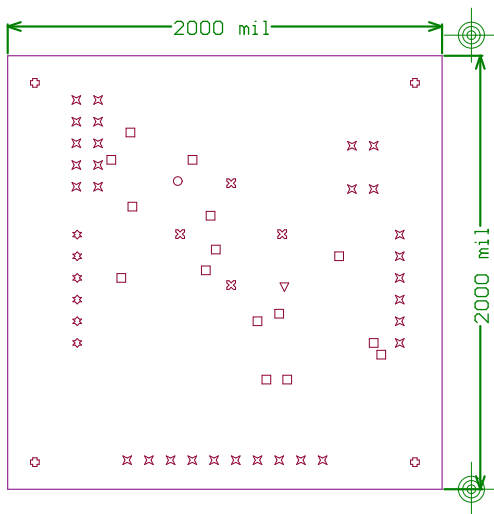

DS9121ATB	
Part Number: ???	
Property of	Rev
maxim integrated™	A
Drill and Mechanical Layer	
Date: NOV 17 2020 Units in mils	

SIZE	QTY	SYM	PLATED	TOLERANCE
12	15	□	YES	+/- 0.003
39	1	▽	NO	+/- 0.003
39	36	◇	YES	+/- 0.003
47	1	○	NO	+/- 0.003
67	4	⊗	YES	+/- 0.003
125	4	⊕	NO	+/- 0.003

Notes:

1. Large soldermask void is normal and necessary under U1 socket
2. Material: RoHS Compliant FR-4 or similar laminate material
3. Board Dimensions: (2000 x 2000 mils)
4. Board Thickness: 62 mils +/- 10%
5. Layers: 2 (Top, Bottom)
6. Minimum Trace/Spacing: 10 trace - 6 space
7. Copper Thickness: 1oz on all layers
8. Surface mount pads: 28 Through Hole Pads: 36 Nonplated through holes: 6 plated mounting holes: 4
9. Soldermask: GREEN
10. Legend: White, top side only
11. Plating: ENIG
12. Finish: Most Economical Lead free and RoHS compliant process
13. Vendor Logo & date code: Allowed on bottom side only
14. Total Drill hole quantity: 61 Slot Holes: 0 Smallest hole size: 12mil
15. Tolerances:
 - Plated-through holes +/- 3 mil
 - Pattern to pattern +/- 6 mil
 - Legend to legend no preference
 - Soldermask to pattern +/- 6 mil
16. Electrical testing needed: YES

62mil PCB

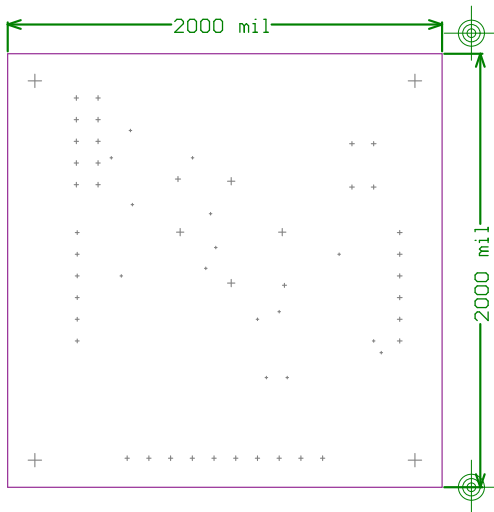

DS9121ATB	
Part Number: ???	
Property of	Rev
 maxim integrated™	A
Drill and Mechanical Layer	
Date: NOV 17 2020 Units in mils	

SIZE	QTY	SYM	PLATED	TOLERANCE
12	15	-	YES	+/- 0.003
39	1	+	NO	+/- 0.003
39	36	+	YES	+/- 0.003
47	1	+	NO	+/- 0.003
67	4	+	YES	+/- 0.003
125	4	+	NO	+/- 0.003

Notes:

1. Large soldermask void is normal and necessary under U1 socket
2. Material: RoHS Compliant FR-4 or similar laminate material
3. Board Dimensions: (2000 x 2000 mils)
4. Board Thickness: 62 mils +/- 10%
5. Layers: 2 (Top, Bottom)
6. Minimum Trace/Spacing: 10 trace - 6 space
7. Copper Thickness: 1oz on all layers
8. Surface mount pads: 28 Through Hole Pads: 36 Nonplated through holes: 6 plated mounting holes: 4
9. Soldermask: GREEN
10. Legend: White. top side only
11. Plating: ENIG
12. Finish: Most Economical Lead free and RoHS compliant process
13. Vendor Logo & date code: Allowed on bottom side only
14. Total Drill hole quantity: 61 Slot Holes: 0 Smallest hole size: 12mil
15. Tolerances:
 - Plated-through holes +/- 3 mil
 - Pattern to pattern +/- 6 mil
 - Legend to legend no preference
 - Soldermask to pattern +/- 6 mil
16. Electrical testing needed: YES

62mil PCB