

Evaluates: MAXM17572 in 5V Output Application

MAXM17572 5V Output Evaluation Kit

General Description

The MAXM17572 5V output evaluation kit (EV kit) provides a proven design to evaluate the MAXM17572 high-voltage, high-efficiency, synchronous step-down DC-DC power module. The EV kit is programmed for 5V output and delivers load currents up to 1A. The programmed switching frequency is 900kHz for optimum efficiency and component size. The EV kit features an adjustable input under-voltage lockout, adjustable soft-start, open-drain $\overline{\text{RESET}}$ signal, and external frequency synchronization. The MAXM17572 module data sheet provides a complete description, features, benefits, and parameters of the part that should be read in conjunction with this EV kit data sheet prior to operating the EV kit.

Features

- Wide 7.0V to 60V Input Range
- Programmed 5V output, up to 1A Output Current
- High 89.4% Efficiency ($V_{\text{IN}} = 24\text{V}$, $V_{\text{OUT}} = 5\text{V}$ at 0.7A)
- 900kHz Switching Frequency
- Enable/UVLO Input, Resistor-Programmable UVLO Threshold
- Programmed 1ms Soft-Start Time
- PWM Mode of Operation
- Open-Drain $\overline{\text{RESET}}$ Output
- External Frequency Synchronization
- Overcurrent and Overtemperature Protection
- Low-Profile, Surface-Mount Components
- Proven PCB Layout
- Fully Assembled and Tested
- Complies with CISPR32 (EN55032) Class B Conducted and Radiated Emissions

Quick Start

Recommended Equipment

- One 0V to 60V DC, 2A Power Supply
- Resistive load with 1.0A sink capacity
- Four Digital Multimeters (DMM)
- One MAXM17572EVKIT# EV kit

Equipment Setup and Test Procedure

The EV kit is fully assembled and tested. Follow the steps to verify the board operation.

Caution: Do not turn on power supply until all connections are completed.

- 1) Set the input power supply at a voltage between 7.0V and 60V. Disable the power supply.
- 2) Connect the positive terminal of the power supply to the VIN_EMI pad and the negative terminal to the nearest GND pad. Connect the positive terminal of the 1.0A resistive load to the VOUT pad and the negative terminal to the nearest GND pad.
- 3) Connect a DMM in voltage measurement mode across the VOUT pad and the nearest GND pad.
- 4) Verify the shunt is installed across pin 1-2 on jumper JU1 (see [Table 1](#) for details).
- 5) Verify that shunts are not installed on jumper JU2 (see [Table 2](#) for details).
- 6) Turn on the input power supply.
- 7) Enable the load.
- 8) Verify that DMM displays 5V across the output terminals.

[Ordering Information](#) appears at end of data sheet.

MAXM17572 5V Output Evaluation Kit

Evaluates: MAXM17572 in 5V Output Application

Detailed Description

The MAXM17572 EV kit is designed to demonstrate the salient features of the MAXM17572 power module. The MAXM17572 provides an option to always enable or disable output through the JU2 setting. Also, the converter can be turned on at desired input voltage with appropriate values of R2 and R3. The RT/SYNC pad provides an interface for synchronizing the device switching with the external clock. An additional RESET pad is available for monitoring output voltage regulation status.

On the bottom layer of the EV kit, additional footprints for optional components are included to ease board modification for different input/output configurations. Placeholders are also available on the bottom layer for the installation of EMI filter components. EMI component values are provided in the [MAXM17572 5V EV Kit Schematic Diagram](#).

Setting the Switching Frequency

Selection of switching frequency must consider input voltage range, desired output voltage, $t_{ON\ MIN}$ of the MAXM17572, and ambient temperature. For optimal performance, a switching frequency of 900kHz is chosen for 5V output. Resistor R1, connected between RT/SYNC and SGND pins, programs the desired switching frequency. Referring to *Table 2. Selection of Components Values* in the MAXM17572 datasheet, R1 is chosen to be 21.5kΩ. Refer to *Table 2* in the MAXM17572 datasheet to see the various switching frequency recommendations optimized for various designs.

Output Capacitor Selection

X7R ceramic output capacitors are preferred due to their stability over the temperature in industrial applications. Refer to *Table 2* in the MAXM17572 datasheet to see a summary of the choice of output capacitor for various requirements. Using this table, the output capacitor (C13) for this EV kit is chosen to be 22μF/25V.

Adjusting Output Voltage

The MAXM17572 supports an adjustable output voltage range, from 0.9V to 12V. To program the different output voltages, use appropriate feedback resistive divider connected between OUT, FB, and GND based on *Table 2* in MAXM17572 datasheet. R7 and R8 of the EV Kit

correspond to RU and RB in *Table 2* of the MAXM17572 datasheet.

Soft-Start Programming

MAXM17572 offers an adjustable soft-start function to limit inrush current during startup. A capacitor connected from the SS pin to SGND programs the soft-start time. The Soft-start time (t_{SS}) is related to the capacitor connected at SS (C11) by the following equation:

$$C11 = 5.55 \times 10^{-6} \times t_{SS}$$

This EV kit is programmed for a 1ms soft-start time, with $C11 = 5.6nF$.

Enable/Under Voltage Lock-out (EN/UVLO) programming

The EV kit includes a resistive voltage divider, formed by R2 and R3, connected from VIN to SGND to turn on the device at the required input voltage (V_{INU}). R2 is selected as 3.3MΩ. By adjusting R3 the input voltage turn-on threshold level is programmed using the below equation.

$$R3 \geq \frac{3.3 \times 1.215}{(V_{INU} - 1.215)}$$

Where R3 is in MΩ.

For MAXM17572 to turn ON at 7V input, the Resistor (R3) is calculated as 698kΩ.

External Clock Synchronization (RT/SYNC)

The EV kit includes the RT/SYNC pad for applying an external clock signal to synchronize with the internal oscillator. The applied external synchronization clock frequency must be between $1.1 \times f_{SW}$ and $1.4 \times f_{SW}$, where f_{SW} is the frequency programmed by the R1 resistor of the EV kit. For further information refer to the MAXM17572 datasheet.

EXTVCC Linear Regulator

The EV kit provides jumper JU1 to power the VCC from VOUT through the EXTVCC function. Bootstrapping the VCC with EXTVCC improves the efficiency at higher input voltages. If the output voltage is greater than 4.7V (typ), connect the OUT terminal to EXTVCC using JU1. See [Table 1](#) for more details.

MAXM17572 5V Output Evaluation Kit

Evaluates: MAXM17572 in 5V Output Application

Electro-Magnetic Interference (EMI)

Compliance to Conducted Emissions (CE) standards requires an EMI filter at the input of a switching power converter. The EMI filter attenuates high-frequency currents are drawn by the switching power converter and limits the noise injected back into the input power source.

The MAXM17572 EV kit PCB has designated footprints on the bottom side for the placement of EMI filter components. Use of EMI filter components as shown in the schematic results in lower conducted emissions, below CISPR32 Class B limits. Cut open the trace at L1, before installing EMI filter components. The EV kit PCB layout is also designed to limit radiated emissions from switching

nodes of the power converter, resulting in radiated emissions below CISPR32 Class B limits.

Hot-Plug-In and Long input cables

The EV Kit PCB provides an electrolytic capacitor (C2, 22 μ F/100V) at the input terminals. This input capacitor limits the peak voltage at the input of the MAXM17572 Power Module, when the DC input source is **Hot-Plugged** to the EV kit input terminals with long input cables. The Equivalent Series Resistance (ESR) of the Electrolytic capacitor damps the oscillations caused by the interaction of the Inductance of the long input cables, and the ceramic capacitors at the Power Module Input.

Table 1. EXTVCC Configuration (JU1)

POSITION	EXTVCC PIN	INTERNAL REGULATOR INPUT
1-2*	Connected to VOUT	VCC is powered from EXTVCC
2-3	Connected to SGND	VCC is powered from VIN

*Default position

Table 2. EN/UVLO Configuration (JU2)

POSITION	EN/UVLO PIN	INTERNAL REGULATOR INPUT
Not Installed*	Connected to the center node of resistor-divider R2 and R3	Programmed to startup at desired input voltage level
1-2	Connected to VIN	Enabled
2-3	Connected to SGND	Disabled

*Default position

MAXM17572 5V Output Evaluation Kit

Evaluates: MAXM17572 in 5V Output Application

EV Kit Performance Report

($V_{IN} = 24V$, $V_{OUT} = 5V$, $I_{OUT} = 1.5A$, $T_A = +25^{\circ}C$. All voltages are referenced to SGND, unless otherwise noted.)

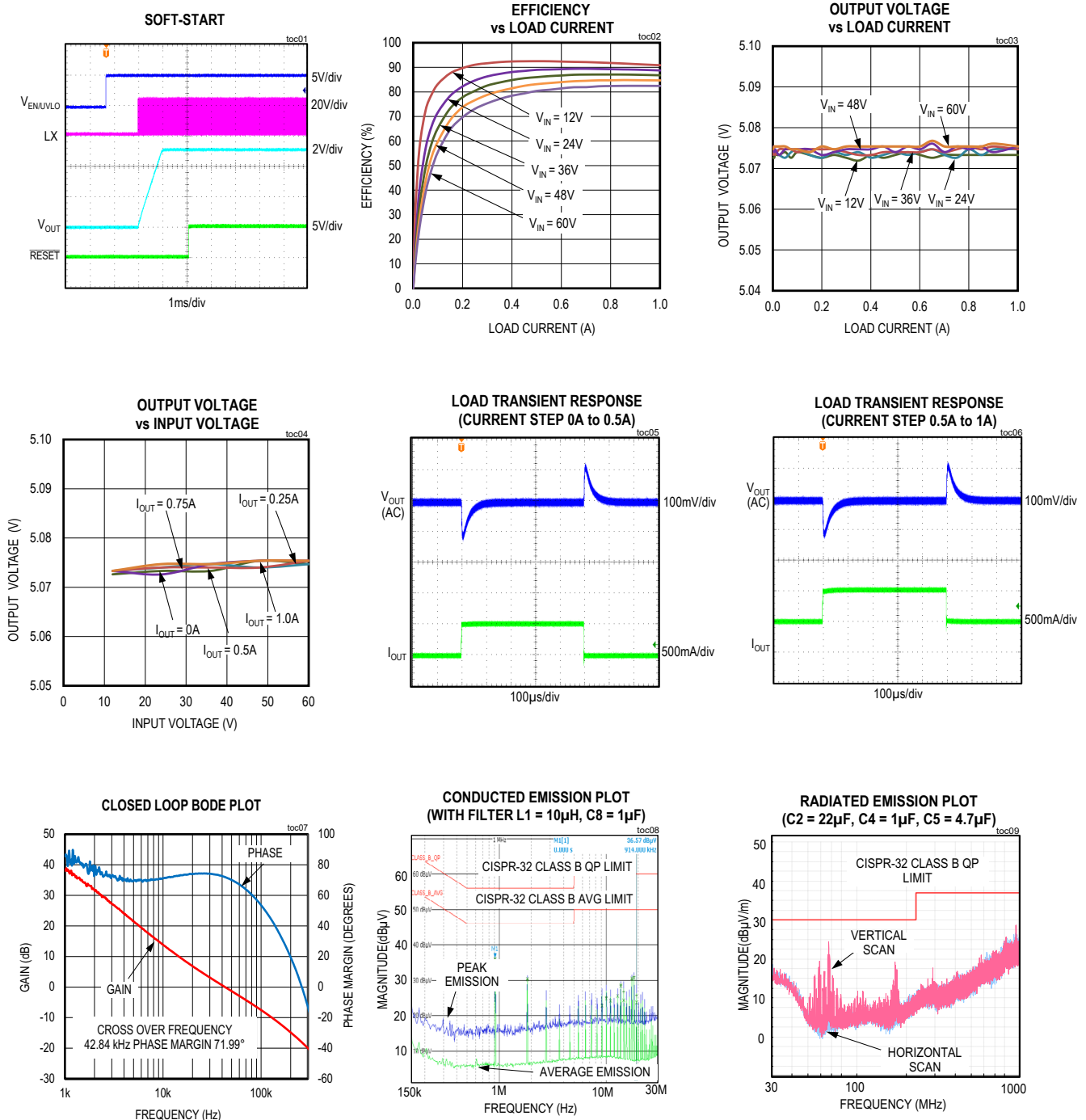

MAXM17572 5V Output Evaluation Kit

Evaluates: MAXM17572 in 5V Output Application

Ordering Information

PART	TYPE
MAXM17572EVKIT#	EV Kit

#Denotes RoHS compliant.

Component Suppliers

SUPPLIER	WEBSITE
Murata Americas	www.murata.com
Panasonic Corp.	www.panasonic.com
Taiyo Yuden	www.yuden.co.jp/or/
TDK Corp.	www.component.tdk.com

Note: Indicate that you are using MAXM17572 when contacting these component suppliers.

MAXM17572 5V EV Kit Bill of Materials

S NO	DESIGNATION	QTY	DESCRIPTION	MANUFACTURER PARTNUMBER
1	C1	1	100pF±10%, 50V, C0G Ceramic Capacitor (0402)	TDK C1005C0G1H101K050BA
2	C2	1	22µF±20%, 100V, Aluminum Capacitor	PANASONIC EEE-TG2A220UP
3	C3	1	2.2µF±10%, 10V, X7R Ceramic Capacitor (0603)	MURATA GRM188R71A225KE15
4	C4, C10	2	0.1µF±10%, 100V, X7R Ceramic Capacitor (0603)	MURATA GRM188R72A104KA35
5	C5	1	4.7µF±10%, 100V, X7R Ceramic Capacitor (1206)	MURATA GRM31CZ72A475KE11
6	C6	1	47pF±5%, 50V, C0G Ceramic Capacitor (0402)	YAGEO CC0402JRNPO9BN470
7	C7	1	OPEN, 150pF±5%, 100V, C0G Ceramic Capacitor (0402)	TDK C1005C0G2A151J050BA
8	C8	1	OPEN, 1µF±10%, 100V, X7R Ceramic Capacitor (1206)	TAIYO YUDEN HMK316B7105K
9	C9, C17	2	OPEN, 220pF±10%, 100V, X7R Ceramic Capacitor (0402)	MURATA GRM155R72A221KA01
10	C11	1	5600pF±10%, 50V, X7R Ceramic Capacitor (0402)	KEMET C0402C562K5RAC
11	C12	1	OPEN (1206)	
12	C13	1	22µF±10%, 25V, X7R Ceramic Capacitor (1210)	MURATA GRM32ER71E226KE15
13	C14, C16	2	0.1µF±10%, 50V, X7R Ceramic Capacitor (0402)	MURATA GRM155R71H104KE14
14	C15	1	0.1µF±5%, 10V, X7R Ceramic Capacitor (0402)	MURATA GRM155R71A104JA01
15	D1	1	Diode, PIV=20V; IF=0.5A	ON SEMICONDUCTOR NSR05F20NXT5G
16	JU1, JU2	2	3-pin header (2.54mm)	SULLINS PCC03SAAN
17	L1	1	OPEN (10µH ±20%, 0.83A Inductor)	MURATA LQH2HPZ100MJR
18	R1	1	21.5kΩ ±1% Resistor (0402)	PANASONIC ERJ-2RKF2152
19	R2	1	3.3MΩ ±5% Resistor (0402)	PANASONIC ERJ-2GEJ335
20	R3	1	698kΩ ±1% Resistor (0402)	PANASONIC ERJ-2RKF6983
21	R4	1	1kΩ ±1% Resistor (0402)	VISHAY DALE CRCW04021K00FK
22	R5	1	10kΩ ±1% Resistor (0402)	VISHAY DALE CRCW040210K0FK
23	R6	1	4.7Ω ±5% Resistor (0402)	PANASONIC ERJ-2GEJ4R7
24	R7	1	118kΩ ±1% Resistor (0402)	PANASONIC ERJ-2RKF1183
25	R8	1	25.5kΩ ±1% Resistor (0402)	VISHAY DALE CRCW040225K5FK
26	SU1, SU2	2	Jumper Socket (2.54mm)	SULLINS STC02SYAN
27	U1	1	MAXM17572, 12-pin uSLIC Power Module	MAXIM INTEGRATED MAXM17572AMC+

MAXM17572 5V Output Evaluation Kit

Evaluates: MAXM17572 in 5V Output Application

MAXM17572 5V EV Kit Schematic Diagram

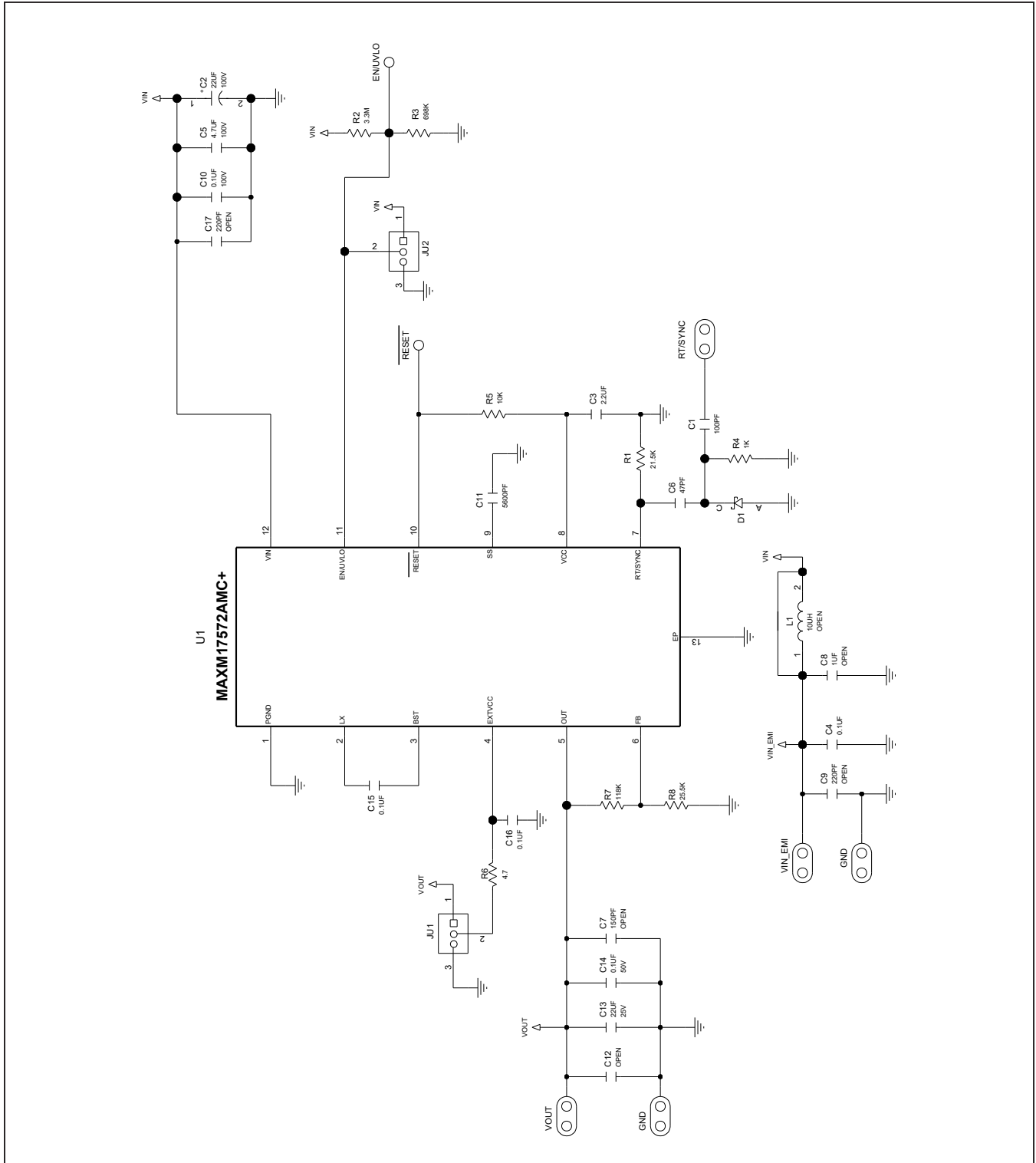

MAXM17572 5V Output Evaluation Kit

Evaluates: MAXM17572 in 5V Output Application

MAXM17572 5V EV Kit PCB Layout Diagrams

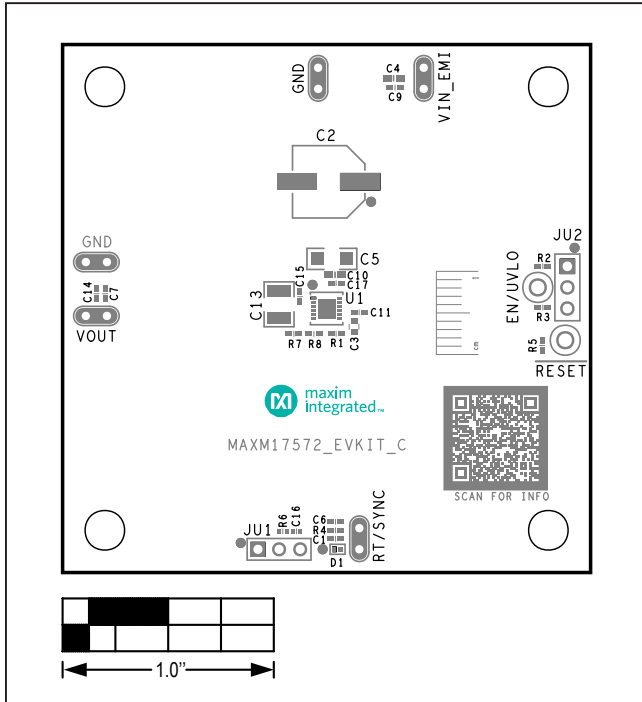

MAXM17572 5V EV Kit Component Placement Guide—Component Side

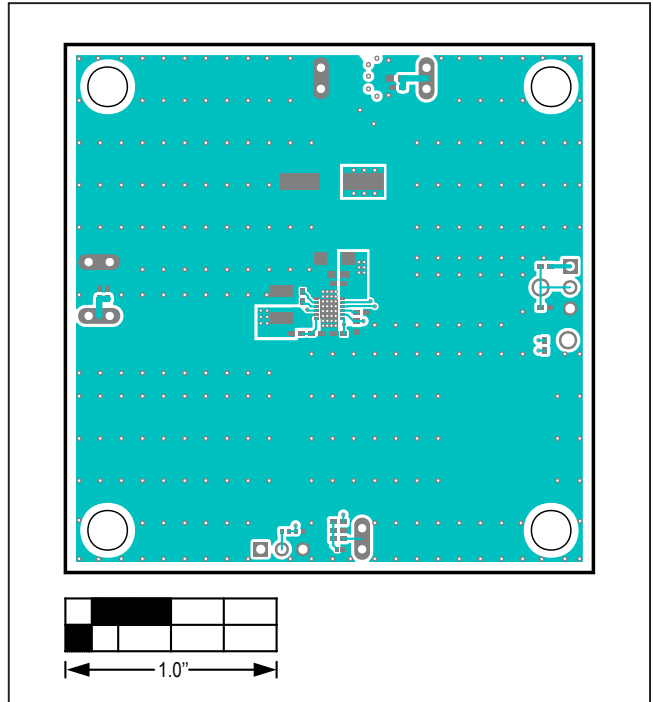

MAXM17572 5V EV Kit PCB Layout—Top Layer

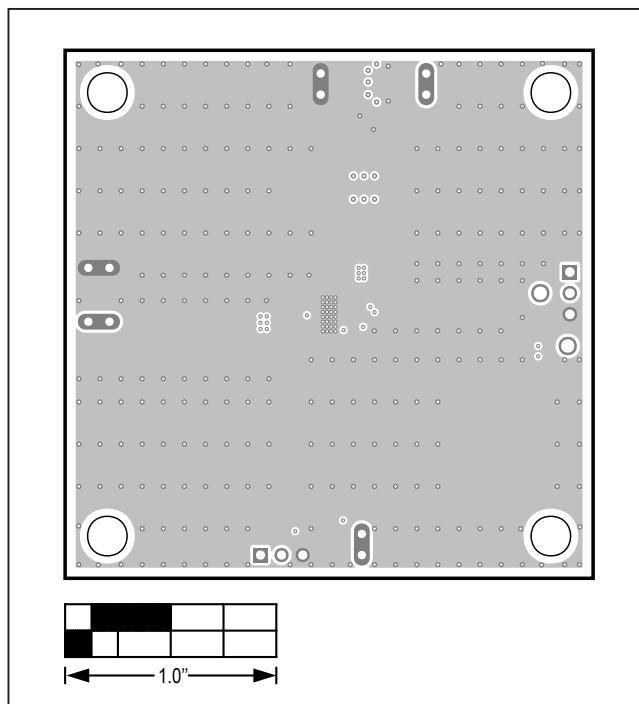

MAXM17572 5V EV Kit PCB Layout—Layer 2

MAXM17572 5V Output Evaluation Kit

Evaluates: MAXM17572 in 5V Output Application

MAXM17572 5V EV Kit PCB Layout Diagrams (continued)

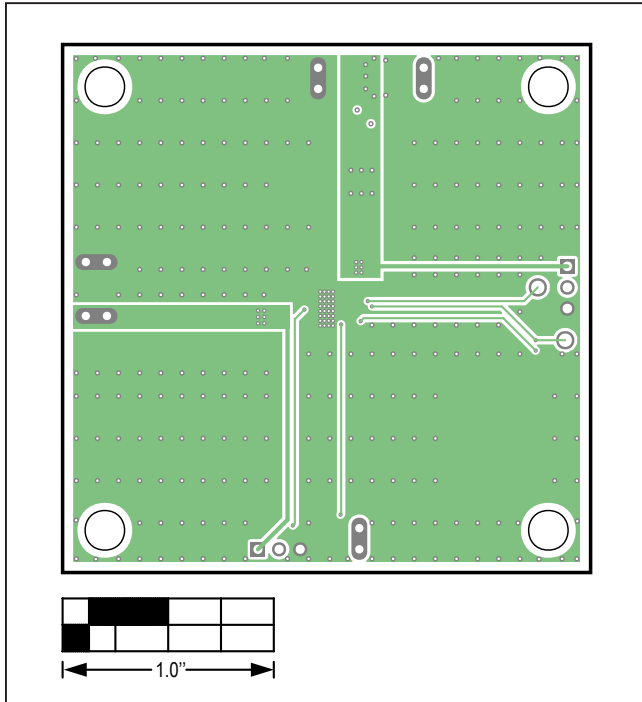

MAXM17572 5V EV Kit PCB Layout—Layer 3

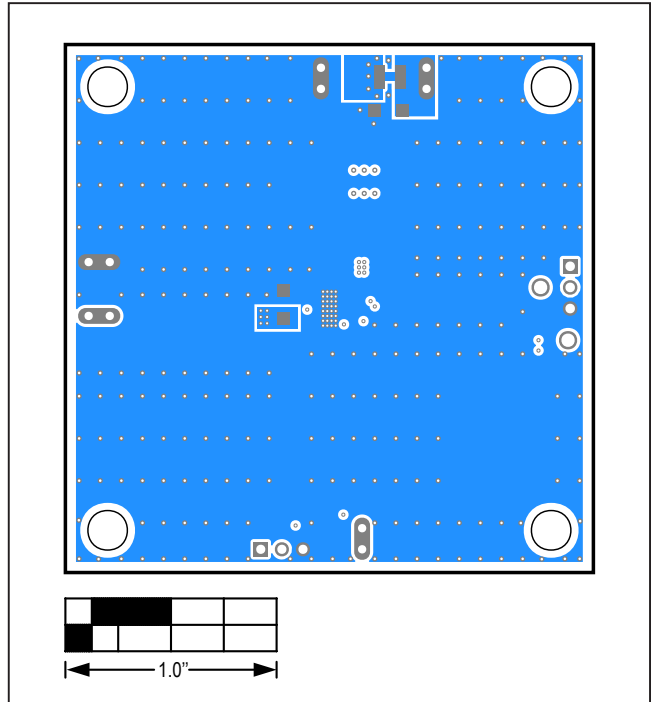

MAXM17572 5V EV Kit PCB Layout—Bottom Layer

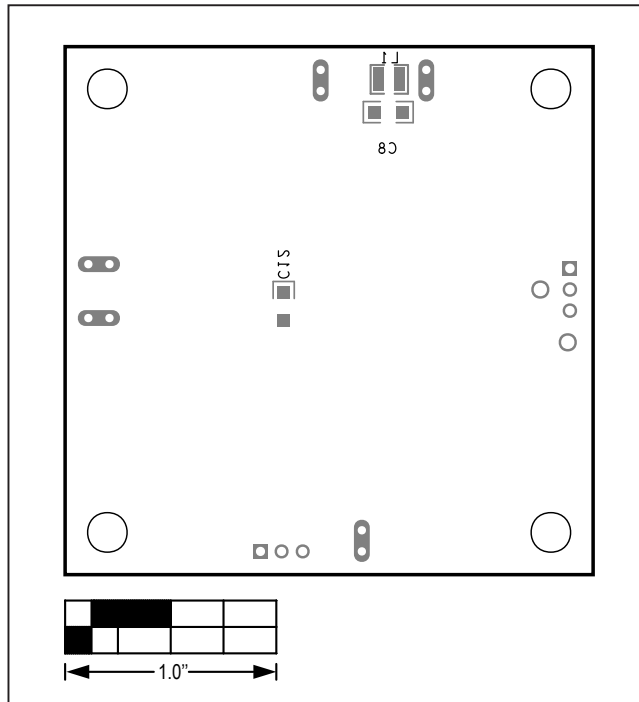

MAXM17572 5V EV Kit PCB Layout—Bottom Silkscreen

MAXM17572 5V Output Evaluation Kit

Evaluates: MAXM17572 in 5V Output Application

Revision History

REVISION NUMBER	REVISION DATE	DESCRIPTION	PAGES CHANGED
0	8/21	Initial release	—

