

## Evaluates: MAX98363 (A/B/C/D)

## MAX98363 Development Board

### General Description

The MAX98363 Development board (DEV board) is a fully assembled and tested application board that evaluates the MAX98363A/MAX98363B/MAX98363C/MAX98363D, tiny SoundWire® v1.2 compatible input Class-D mono amplifiers.

The MAX98363 Development board is designed to work with an external SoundWire manager, which would provide the v1.2 SoundWire Clock and Data. Only a single supply input of 2.5V to 5.5V for VDD is required for powering the DEV board. [Figure 1](#) and [Figure 2](#) detail the DEV board connections and jumper locations.

### Features

- MIPI SoundWire v1.2 Compliant
- 3.2W Output Power into 4Ω at 5V
- Single-Supply Operation (2.5V to 5.5V)
- 12.3mW Quiescent Power with External DVDDIO
- 92% Efficiency (RL = 8Ω, THD+N = 10%)
- 12.8μVRMS Output Noise
- 108.5dB Dynamic Range
- Low 0.014% THD+N at 1kHz
- Sophisticated Edge Rate Control Enables Filterless Class-D Outputs
- Extensive Click-and-Pop Reduction Circuitry
- Available in Space-Saving Package: 9 Bump, Wafer-Level Package (WLP)
  - 1.528mm x 1.528mm, 0.4mm Pitch

[Ordering Information](#) appears at end of data sheet.

*Windows and Windows Media Player are registered trademarks and registered service marks of Microsoft Corporation.  
SoundWire is a registered trademark and registered service mark of MIPI Alliance.  
iTunes is a registered trademark of Apple Inc.*

### MAX98363 Development Board Photo

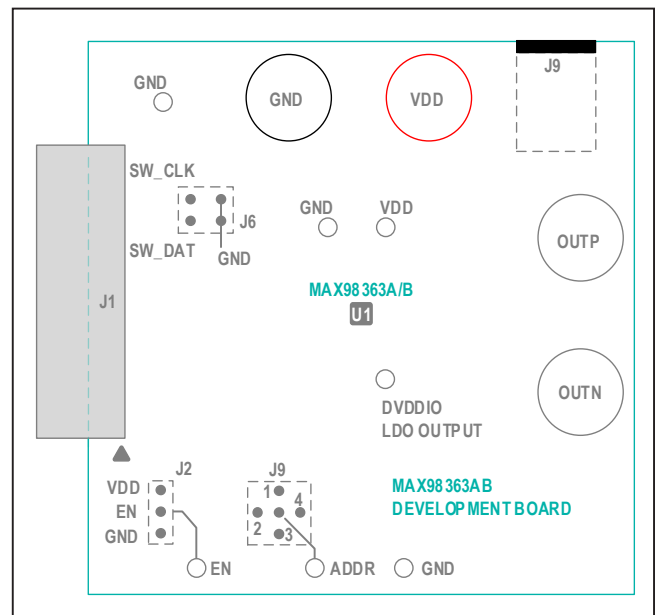
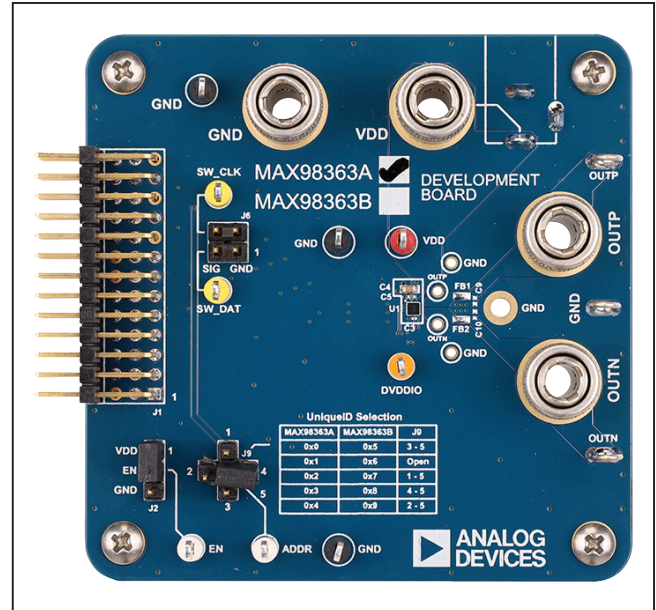

Figure 1. MAX98363A/MAX98363B Development Board

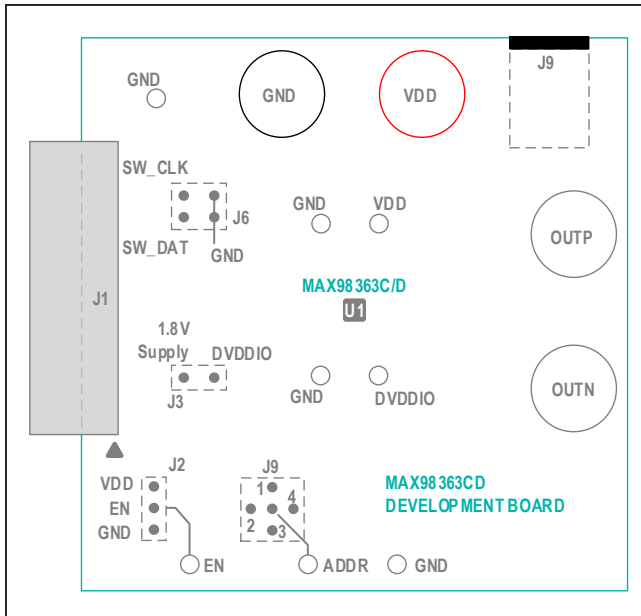

Figure 2. MAX98363C/MAX98363D Development Board

## Configuring the MAX98363 Development Board for Testing

A user supplied SoundWire Manager must be used to control all the MAX98363 registers and digital audio streaming. Audio test equipment (Audio Precision, etc.) is connected to the amplifier output. Note that there is also the MAX98363 evaluation software, which is available to be used as a visual reference only (for the device registers and block diagrams). The MAX98363 Evaluation Software operates in “Demo Mode” only and does not control or interface with the DEV board in any manner.

### Software Installation (Optional):

- 1) Download the latest software from the Analog Devices website.
  - Visit [www.analog.com/products/MAX98363](http://www.analog.com/products/MAX98363) to download the latest version of the MAX98363 EV kit software. Save the EV kit software to a temporary folder and unpack the .zip file.
- 2) Install the software and follow the prompts till the end.
  - Install the software on the computer by running the MAX98363EVSwSetupVxx.exe program. Program files are copied and icons are created in the **Windows Start | Programs | Maxim Integrated | MAX98363 Evaluation Software** menu. During software installation, MS Windows may display a message indicating the software is from an unknown publisher. This is not an error condition, and it is safe to proceed with the installation.

### Hardware Assembly:

- 3) Check jumpers on Dev board.
  - Enable: Set the ENABLE jumper, J2, to VDD.
  - Address: Use jumper J9 to select a SoundWire Unique ID (see [Table 2](#)).
  - For MAX98363C/MAX98363D only: Add jumper J3 to connect the external 1.8V LDO (U2) to DVDDIO of the MAX98363C/MAX98363D.
- 4) Connect a test load.
  - Use the OUTP and OUTN binding posts to connect a test load or speaker between 4Ω to 8Ω. **Note:** when using a test load on a Class-D amplifier, a series inductor is required (33μH is recommended).
- 5) Connect the VDD power supply (with the supply not powered).
  - Connect a 2.5V to 5.5V power supply (with the supply not powered) across the VDD and GND binding posts of the MAX98363 Development Board or use the 2.1mm X 5.5mm barrel connector J10 on the bottom.
- 6) Turn on the VDD power supply.
  - Set a voltage between 2.5V and 5.5V.

### Test Equipment Playback Test

- 7) Launch the audio test equipment software.
- 8) Launch the SoundWire Manager and configure.
- 9) Connect the SoundWire Manager to the J6 header
  - From the SoundWire Manager, connect the SoundWire Clock, SoundWire Data, and ground leads to the SW\_CLK, SW\_DATA, and GND on the J6 header, respectively (see [Table 4](#)).
- 10) Connect the audio test equipment to the amplifier's output.
  - Connect OUTP, OUTN, and GND to the input of a switching amplifier measurement filter. A switching amplifier measurement filter is needed when collecting measurements from the output of a Class-D amplifier.
  - Connect the filter output to the input of the audio test equipment.
- 11) Configure the MAX98363 for playback.
  - After the MAX98363 device is registered with the SoundWire Manager, configure it for audio playback.
- 12) This completes setting up the MAX98363 for bench testing.

Detailed Description of Software

**Note:** In the following sections, software-related items are identified in bold. Text in **bold** refers to items directly from the evaluation software. Text in **bold and underlined** refers to items from the MS Windows operating system.

MAX98363 evaluation software is designed to be used only as a reference tool with the MAX98363 DEV board. The software provides an intuitive graphical-user interface (GUI) for viewing the registers and features of the MAX98363 device. The MAX98363 evaluation software operates in “Demo Mode” only and does not control or interface with the DEV board in any manner.

The main window of the MAX98363 evaluation software is composed of four main sections: menu bar, communication tool bar, tabbed pages, and a status bar (see

Figure 3). The tabbed pages constitute the bulk of the GUI and displays the hardware register’s names, addresses, and provides a block diagram of the MAX98363.

The **Block Diagram** tab shows all the device registers using dialog windows. The dialog windows are opened by clicking on the blocks in the block diagram. The **Control Registers** tab displays all the valid registers from 0x2001 to 0x2044. The **SoundWire Register** tab displays all the SoundWire registers from 0x0040 to 0x0137.

The MAX98363 evaluation software is compatible with MS Windows 7 and Windows 10 and can be found on Analog Devices website (Analog.com). Refer to the MAX98363 IC data sheet and the MIPI SoundWire Specification (Version 1.2) for detailed device register information.

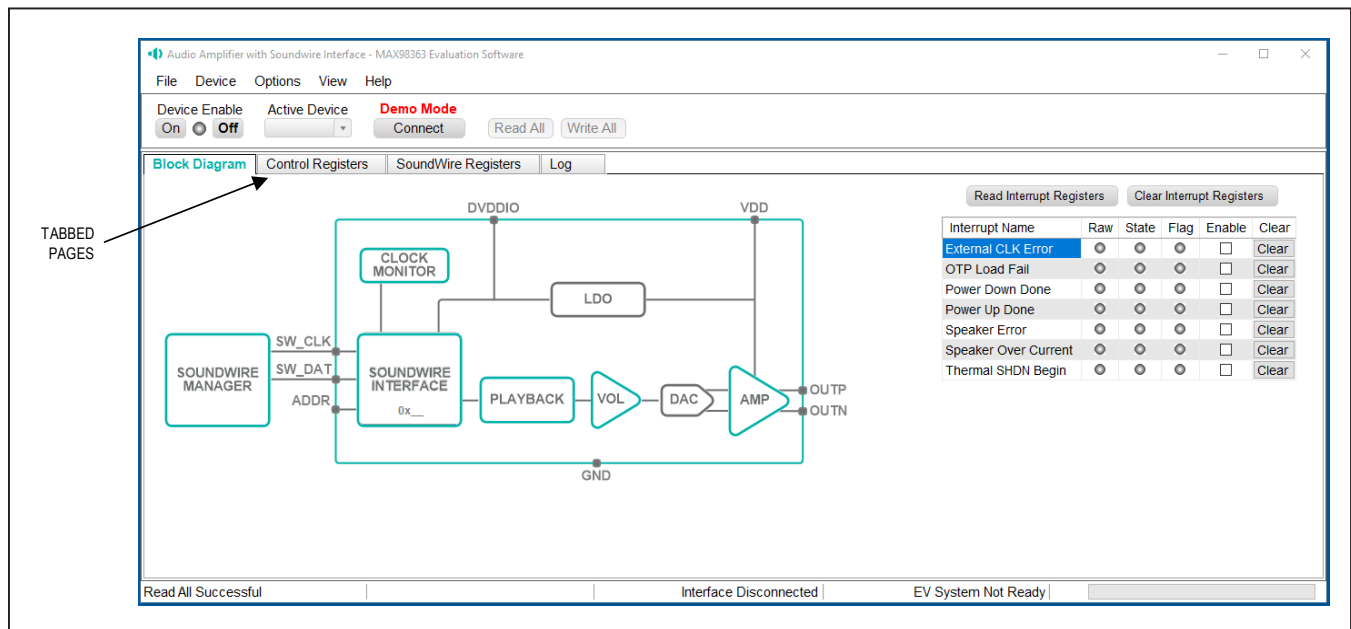

Figure 3. MAX98363 Evaluation Software

### Block Diagram Tab

The evaluation software uses a block diagram to display the programmable features of the MAX98363 device. There are two types of blocks in the block diagram. The cursor changes to a hand when over a block that has an associated dialog window. If the cursor does not change (i.e., remains an arrow), then that block does not have an associated dialog window. Clicking on a dialog block opens a dialog window, displaying the features for that functional block.

### Dialog Windows

A dialog window is opened by clicking on a dialog block. [Figure 4](#) shows some of the typical GUI controls that are found in a dialog window.

### Control Registers Tab

The **Control Registers** tab displays the MAX98363 programmable register addresses and names.

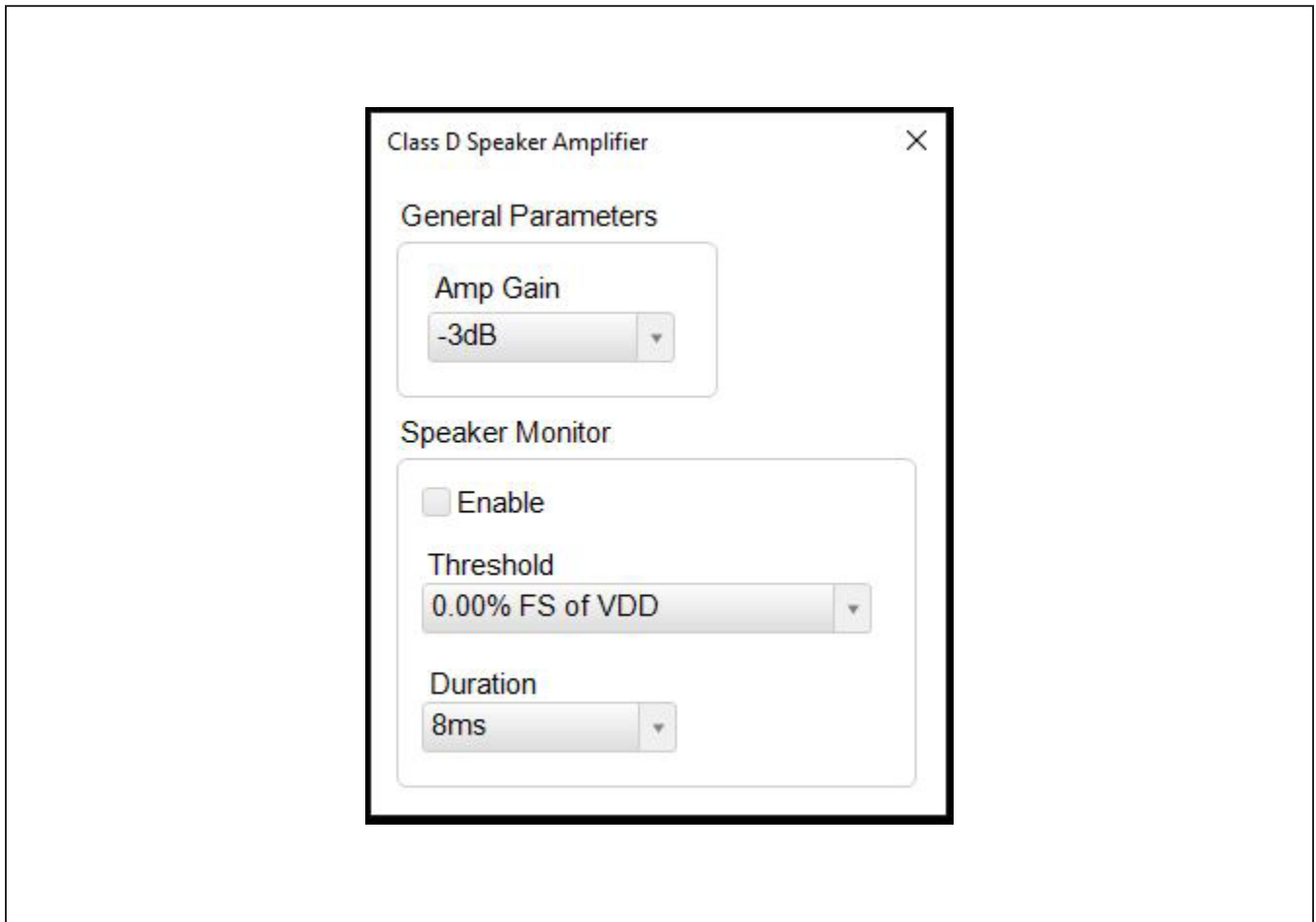

Figure 4. Dialog Block for AMP controls

## Detailed Description of Hardware

The MAX98363 Development board is designed for a thorough evaluation of the MAX98363 SoundWire v1.2 compatible input Class-D mono amplifier.

To simplify evaluation, the MAX98363 DEV board can be evaluated with an external power supply for VDD, and by a SoundWire stream driven directly by specialized audio test equipment or a computer with SoundWire capabilities and driver.

### Power Supplies

The MAX98363 DEV board requires an external power supply for VDD (2.5V to 5.5V). Connect the external supply at the respective supply test points, binding posts, or the barrel connector J10, located at the bottom of the DEV board (see [Figure 1](#) or [Figure 2](#)).

For the MAX98363A/MAX98363B, the 1.8V DVDDIO voltage is automatically generated by the device through an internal LDO. This voltage can be measured at the DVDDIO test point.

The MAX98363C/MAX98363D, requires the use of an additional power supply for DVDDIO. For convenience, an external LDO is included on the MAX98363C/D DEV board. The external LDO (U2) is mounted on the

bottom of the DEV board and can be connected to the MAX98363's DVDDIO pin by applying a shunt to header J3. Or a DVDDIO supply can be applied externally to the DEV board, to do this, remove J3 and apply the voltage directly to the DVDDIO test point. Note for the MAX98363C/D to operate, a voltage between 1.7V and 1.9V must be applied to DVDDIO.

When measuring quiescent current on the MAX98363C/MAX98363D, disable the LDO by removing the 0Ω resistor R8. To disable the LDO and remove the current it draws from VDD, remove the 0Ω resistor R8 located at the bottom of the DEV board and depopulate J3 on the DEV board.

### Selecting the DEV Board Jumper

#### Enable

The jumper J2 controls the EN pin. The MAX98363 device features a hardware shutdown mode activated by connecting the EN pin to GND. This is the lowest power state, where all device registers are returned to their PoR values and the SoundWire control interface is disabled. To exit the hardware shutdown mode, first move jumper J2 from the GND to the VDD position, then use a SoundWire Manager to initialize the device. See [Table 1](#) for reference.

**Table 1. Enable Jumper Configuration (J2)**

HEADER	SHUNT POSITION	DESCRIPTION
J2	EN to VDD	Normal Operation
	EN to GND	Shutdown

**Table 2. Unique ID Jumper Configuration (J9)**

HEADER	PART NUMBER	SHUNT POSITION	DESCRIPTION	DEVICE UNIQUE ID
J9	MAX98363ADEV# MAX98363CDEV#	5 to 3	ADDR to GND	0x0
		Open	Unconnected	0x1
		5 to 1	ADDR to VDD	0x2
		5 to 4	ADDR to VDD through 100kΩ	0x3
		5 to 2	ADDR to GND through 100kΩ	0x4
	MAX98363BDEV# MAX98363DDEV#	5 to 3	ADDR to GND	0x5
		Open	Unconnected	0x6
		5 to 1	ADDR to VDD	0x7
		5 to 4	ADDR to VDD through 100kΩ	0x8
		5 to 2	ADDR to GND through 100kΩ	0x9

**Table 3. DVDDIO Jumper Configuration—MAX98363C/MAX98363D Only (J3)**

HEADER	SHUNT POSITION	DESCRIPTION
J3	Open	Power the device’s DVDDIO using external supply.
	1.8V LDO Supply to DVDDIO	On-board 1.8V LDO U2 is used to supply MAX98363C/ MAX98363D DVDDIO.

**Unique ID Address**

The 4-bit SoundWire peripheral device unique ID is pin configurable and has five possible combinations for a given part number. A combination of part number and pin configurability allows up to ten possible combinations of unique IDs. To select a specific unique ID, use J9 to connect the ADDR pin as shown in [Table 2](#).

**For MAX98363C/MAX98363D Only, External DVDDIO**

For proper operation of the MAX98363C/D, a DVDDIO voltage must be applied. If an external DVDDIO bench supply is to be applied, do not populate J3. If the external LDO located on the DEV board (U2) is to be used, then apply a shunt to J3 (see [Table 3](#)).

**SoundWire Header (J6)**

Header J6 provides direct access to the MAX98363’s SoundWire Clock and Data inputs, and facilitates evaluation with audio test equipment I/O (see [Table 4](#)).

**Speaker Output**

The speaker output of the MAX98363 is routed to the OUTP and OUTN connections on the DEV board.

**Table 4. SoundWire Header (J6)**

SIGNAL	PIN	PIN	SIGNAL
SoundWire Clock	4	3	GND
SoundWire Data	2	1	GND

The DEV board is, by default, assembled to allow the MAX98363 output to connect directly to a speaker load without the need for filtering.

**EMI Filter**

When long speaker cables are used with the MAX98363 output (exceeding ≈12in (30 cm)), install a ferrite bead plus capacitor filter to prevent excessive EMI radiation. Although it is best to choose filter components based on EMI test results, the combination of 100pF capacitors (C9, C10) and ferrite beads (FB1, FB2) generally work well. An example ferrite bead to consider is the Murata BLM18SG331TN1D. Before adding the filters to the design, first remove the small PCB traces shorting the pads of FB1 and FB2 (see the [MAX98363 WLP EV Kit Development Board Schematic](#) and the [MAX98363 WLP EV Kit Development Board Layout Diagrams](#)).

**Ordering Information**

PART NUMBER	DESCRIPTION
MAX98363ADEV#	Evaluation Board, SoundWire Unique ID 0x0 to 0x4
MAX98363BDEV#	Evaluation Board, SoundWire Unique ID 0x5 to 0x9
MAX98363CDEV#	Evaluation Board, External LDO for DVDDIO, SoundWire Unique ID 0x0 to 0x4
MAX98363DDEV#	Evaluation Board, External LDO for DVDDIO, SoundWire Unique ID 0x5 to 0x9

#Denotes an RoHS-compliant device.

# MAX98363 Development Board

Evaluates: MAX98363 (A/B/C/D)

## PCB Design Files

The following sections contain detailed information on the MAX98363A/MAX98363B and MAX98363C/MAX98363D development board BOM (Bill of Materials), schematic, and layout.

## MAX98363A/MAX98363B WLP Development Board Bill of Materials

#	QUANTITY	DESIGNATOR	DESCRIPTION	VALUE	VOLTAGE	TOLERANCE	POWER	DIELECTRIC	PACKAGE	MANUFACTURER	MANUFACTURER PN	MOUSER	DigiKey
1	1	C3	Capacitor / Ceramic / 2.2µF / 10V / 10% / X5R / 0201	2.2µF	10V	10%		X5R	201	Murata	GRM033R61A225KE47D	81-GRM033R61A225KE7D	490-13227-1-ND
2	1	C4	Cap / 10µF / 10V / 10% / X5R / 0603	10µF	10V	10%		X5R	603	Murata	GRM188R61A106KE9D	81-GRM188R61A106KE9D	490-10474-1-ND
3	1	C5	Cap / 100nF / 16V / 10% / X7R / 0402	100nF	16V	10%		X7R	402	Murata	GCM155R71C104KA5D	81-GCM155R71C104KA5D	490-4759-1-ND
4	1	J1	Updated EVkit Daughter Card Header							Samtec	TSW-113-08-G-T-RA		
5	1	J2	Header, 3x1 Position, 0.1" Pitch							Samtec	TSW-103-07-G-S	200-TSW10307GS	SAM1029-03-ND
6	4	J5, J7, J14, J15	Binding Post							Johnson	111-2223-001		J587-ND
7	1	J6	Header, 2x2 Position, 0.1" Pitch							Samtec	TSW-102-07-G-D	200-TSW10207GD	SAM1028-02-ND
8	1	J9	Header / 0.1" Pitch / Unshrouded / 5-pin / Breakaway / Cross Pattern							Molex	22-28-4055	538-22-28-4055	WM24204-ND
9	1	J10	Power Barrel Connector Jack 2.10mm ID (0.083"), 5.50mm OD (0.217") Through Hole, Right Angle							MPD	EJ503A		EJ503A-ND
10	3	J13, J16, J17	Wire Lode / 20AWG / Tinned Copper / 25mm Length							20TCW			2328-20TCW-ND
11	1	R2	Resistor / 30.1kΩ / 1% / 1/16W / 0402	30.1k		1%	1/16W		402	Yageo	RC0402FR-0730K1L	603-RC0402FR-0730K1L	311-30.1KLRCT-ND
12	2	R3, R4	Resistor / 0Ω / 1% / 1/16W / 0402	0		1%	1/16W		402	Yageo	RC0402FR-070RL	603-RC0402FR-070RL	311-0.0LRCT-ND
13	2	R6, R7	Resistor / 100kΩ / 1% / 1/16W / 0402	100k		1%	1/16W		402	Yageo	RC0402FR-07100KL	603-RC0402FR-07100KL	311-100KLRCT-ND
14	4	SC1, SC2, SC3, SC4	Screw / 4-40 x 1/4" / Phillips / Pan Head							McMaster-Carr	91772A106		
15	4	ST1, ST2, ST3, ST4	Standoff / 4-40 x 1/2" / Female-Female / 1/4" Hex							McMaster-Carr	91780A164		
16	2	TP1, TP11	Test Point / Compact / White							Keystone Electronics	5007	534-5007	5007K-ND
17	2	TP2, TP3	Test Point / Compact / Yellow							Keystone Electronics	5009	534-5009	5009K-ND
18	1	TP4	Test Point / Compact / Orange							Keystone Electronics	5008	534-5008	5008K-ND
19	3	TP12, TP13, TP15	Test Point / Multi-Purpose / Black							Keystone Electronics	5011	534-5011	5011K-ND
20	1	TP14	Test Point / Multi-Purpose / Red							Keystone Electronics	5010	534-5010	5010K-ND
21	1	U1	Tiny, Cost-effective Soundwire Class-D Amplifier						WLP9	ADI	MAX98363AEWL+ MAX98363BEWL+		

## MAX98363A/MAX98363B WLP Development Board Schematic

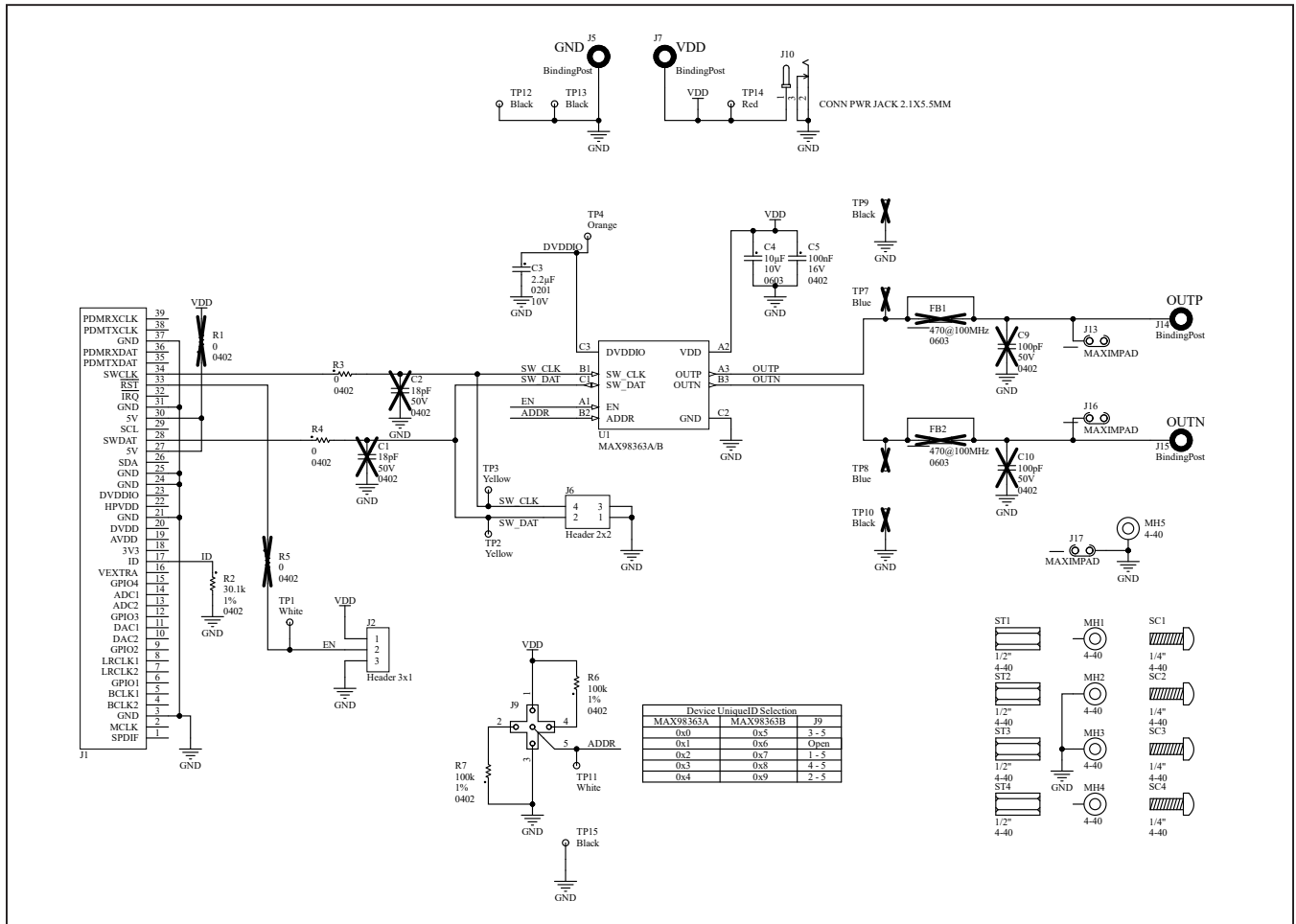

# MAX98363 Development Board

Evaluates: MAX98363 (A/B/C/D)

## MAX98363A/MAX98363B WLP Development Board PCB Layout Diagrams

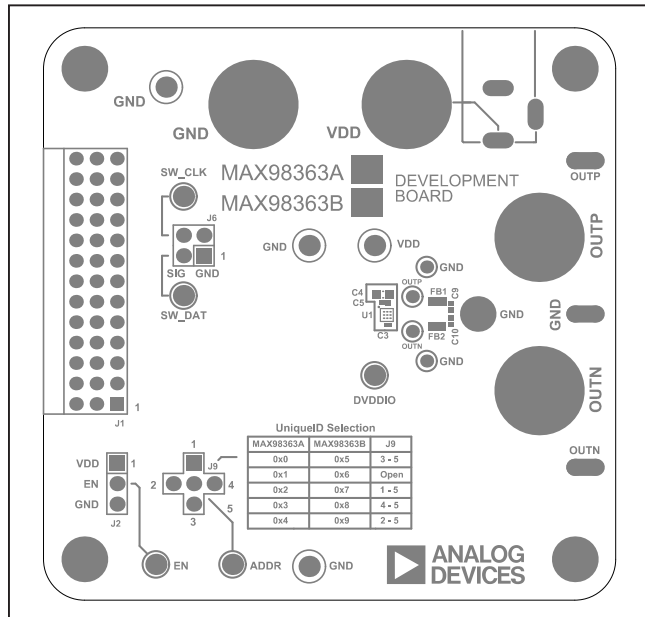

MAX98363A/MAX98363B Dev Board Component Placement Guide—Top Silkscreen

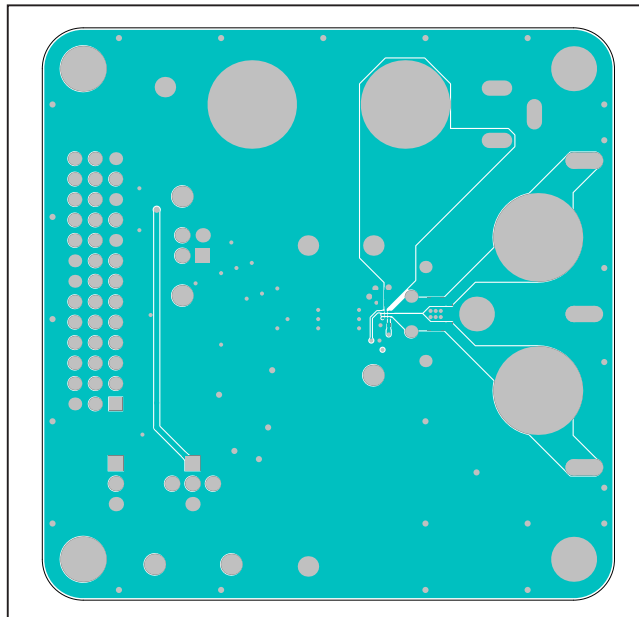

MAX98363A/MAX98363B Dev Board PCB Layout—Top Layer

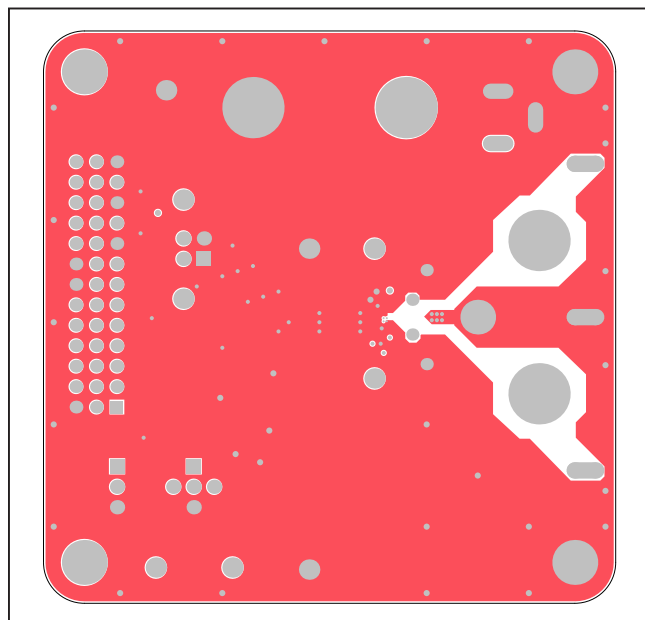

MAX98363A/MAX98363B Dev Board PCB Layout—Layer 2

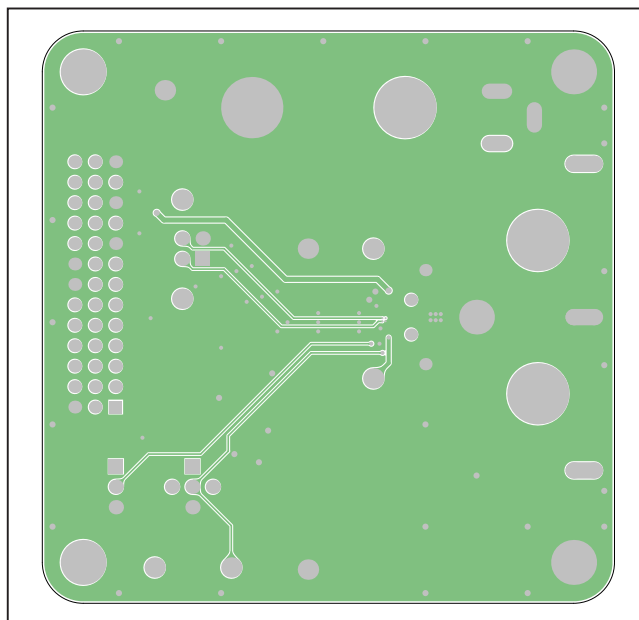

MAX98363A/MAX98363B Dev Board PCB Layout—Layer 3



MAX98363A/MAX98363B WLP Development Board PCB Layout Diagrams (continued)

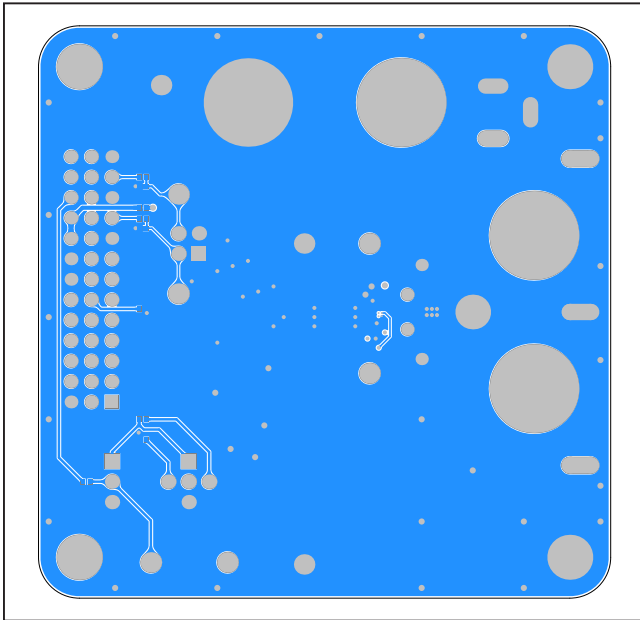

MAX98363A/MAX98363B Dev Board PCB Layout—Bottom Layer

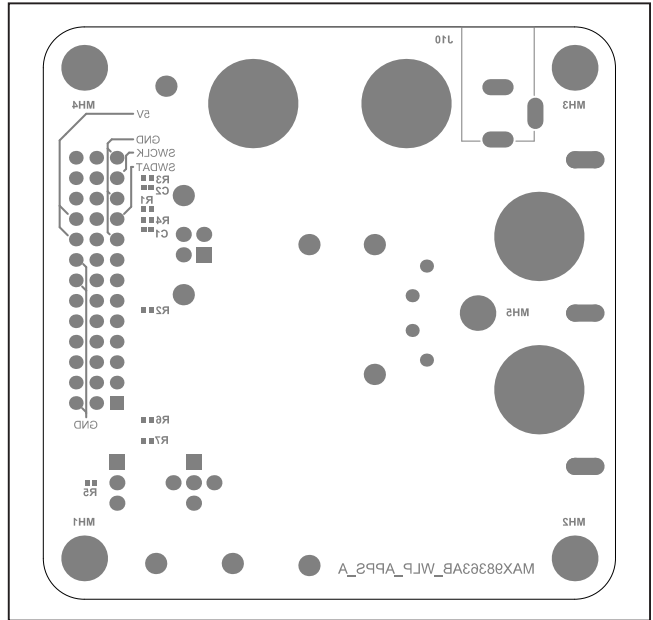

MAX98363A/MAX98363B Dev Board Component Placement Guide—Bottom Silkscreen

# MAX98363 Development Board

Evaluates: MAX98363 (A/B/C/D)

## MAX98363C/MAX98363D WLP Development Board Bill of Materials

#	QUANTITY	DESIGNATOR	DESCRIPTION	VALUE	VOLTAGE	TOLERANCE	POWER	DIELECTRIC	PACKAGE	MANUFACTURER	MANUFACTURER PN	MOUSER	DigiKey
1	1	C3	Capacitor / Ceramic / 100nF / 10V / 10% / XSR / 0201	100nF	10V	10%		XSR	201	Murata	GRM033R61A104KE15D	81-GRM033R61A104KE5D	490-5881-1-ND
2	3	C4, C11, C12	Cap / 10µF / 10V / 10% / XSR / 0603	10µF	10V	10%		XSR	603	Murata	GRM188R61A106KE9D	81-GRM188R61A106KE9D	490-10474-1-ND
3	2	C5, C13	Cap / 100nF / 16V / 10% / XTR / 0402	100nF	16V	10%		XTR	402	Murata	GCM188R71C104KAS5D	81-GCM188R71C104KAS5D	490-4796-1-ND
4	1	J1	Updated EVM Daughter Card Header							Samtec	TSW-113-28-G-T-RA		
5	1	J2	Header, 3x1 Position, 0.1" Pitch							Samtec	TSW-103-07-G-S	200-TSW10307GS	SAM1029-03-ND
6	1	J3	Header, 2x1 Position, 0.1" Pitch							Samtec	TSW-102-07-G-S	200-TSW10207GS	SAM1029-02-ND
7	4	J5, J7, J14, J15	Binding Post							Johnson	111-2223-001		J587-ND
8	1	J8	Header, 2x2 Position, 0.1" Pitch							Samtec	TSW-102-07-G-D	200-TSW10207GD	SAM1029-02-ND
9	1	J9	Header / 0.1" Pitch / Unshrouded / 5-pin / Breakaway / Cross Pattern							Molex	22-28-4055	538-22-28-4055	WM24204-ND
10	1	J10	Power Barrel Connector Jack 2.10mm ID (0.083"), 5.50mm OD (0.217") Through Hole, Right Angle							MPD	EJ503A		EJ503A-ND
11	3	J13, J16, J17	Wire Loop / 20AWG / Tinned Copper / 25mm Length								20TCW		2328-20TCW-ND
12	1	R2	Resistor / 30.1kΩ / 1% / 1/16W / 0402	30.1k		1%	1/16W		402	Yageo	RC0402FR-0730K1L	603-RC0402FR-0730K1L	311-30.1KLRCCT-ND
13	3	R3, R4, R8	Resistor / 0Ω / 1% / 1/16W / 0402	0		1%	1/16W		402	Yageo	RC0402FR-070RL	603-RC0402FR-070RL	311-0.0LRCCT-ND
14	2	R6, R7	Resistor / 100kΩ / 1% / 1/16W / 0402	100k		1%	1/16W		402	Yageo	RC0402FR-07100KL	603-RC0402FR-07100KL	311-100KLRCCT-ND
15	4	SC1, SC2, SC3, SC4	Screw / 4-40 x 1/4" / Phillips / Pan Head							McMaster-Carr	91772A106		
16	4	ST1, ST2, ST3, ST4	Standoff / 4-40 x 1/2" / Female-Female / 1/4" Hex							McMaster-Carr	91780A164		
17	2	TP1, TP11	Test Point / Compact / White							Keystone Electronics	5007	534-5007	5007K-ND
18	2	TP2, TP3	Test Point / Compact / Yellow							Keystone Electronics	5009	534-5009	5009K-ND
19	1	TP4	Test Point / Multi-Purpose / Orange							Keystone Electronics	5013	534-5013	5013K-ND
20	4	TP5, TP12, TP13, TP15	Test Point / Multi-Purpose / Black							Keystone Electronics	5011	534-5011	5011K-ND
21	1	TP14	Test Point / Multi-Purpose / Red							Keystone Electronics	5010	534-5010	5010K-ND
22	1	U1	Tiny, Cost-effective Soundwire Class-D Amplifier						WLP8	ADI	MAX98363CEWL+		
23	1	U2	Low-Dropout, 300mA Linear Regulators in SOT23 - 1.8V		1.8V				SOT23-5	Maxim/ADI	MAX8887EZK18+	700-MAX8887EZK18	MAX8887EZK18+TCT-ND

## MAX98363C/MAX98363D WLP Development Board Schematic

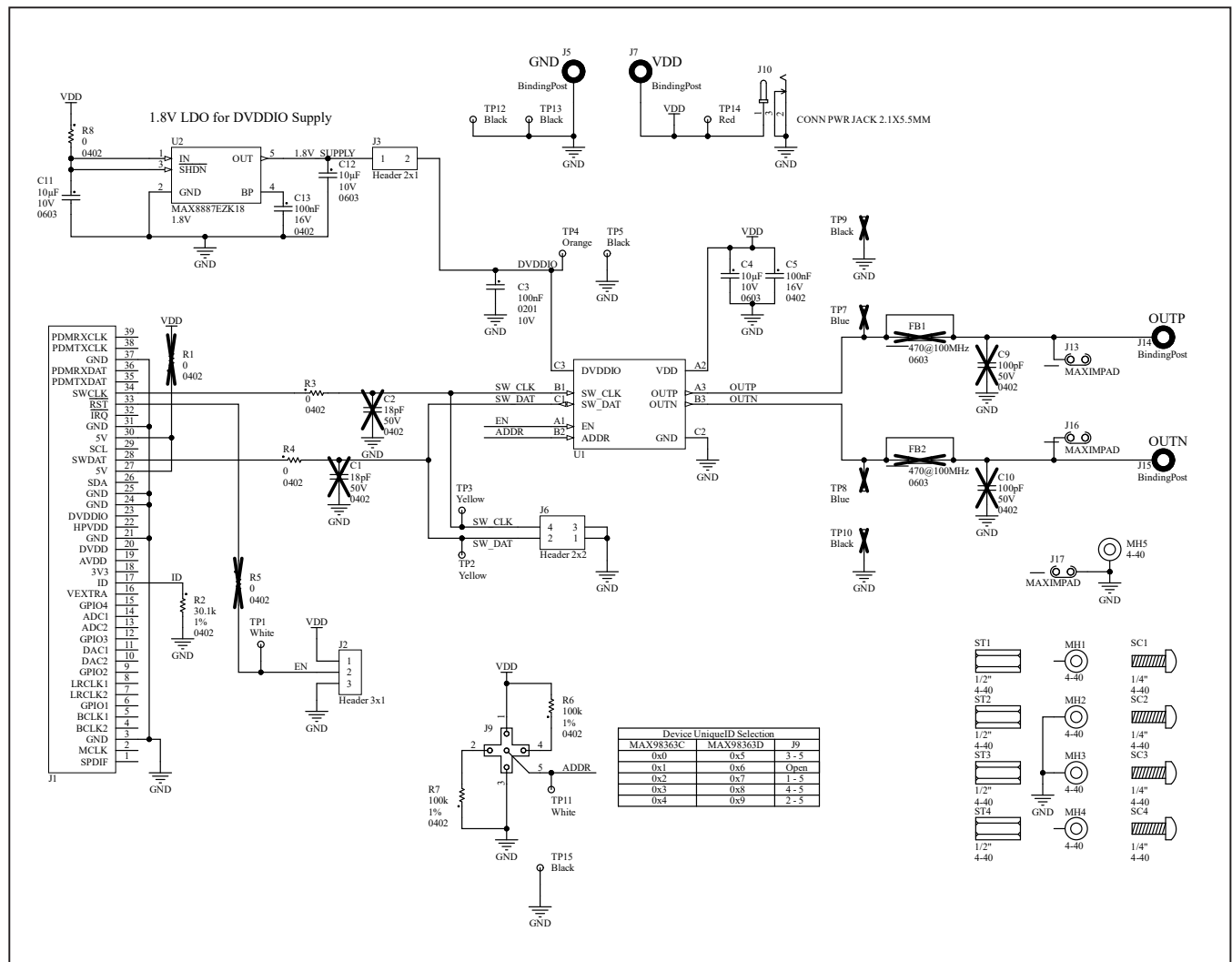

# MAX98363 Development Board

Evaluates: MAX98363 (A/B/C/D)

## MAX98363C/MAX98363D WLP Development Board PCB Layout Diagrams

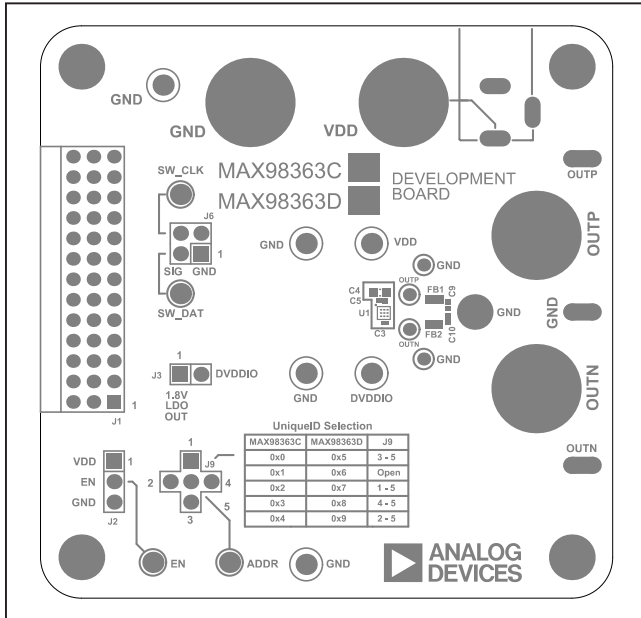

MAX98363C/MAX98363D Dev Board Component Placement Guide—Top Silkscreen

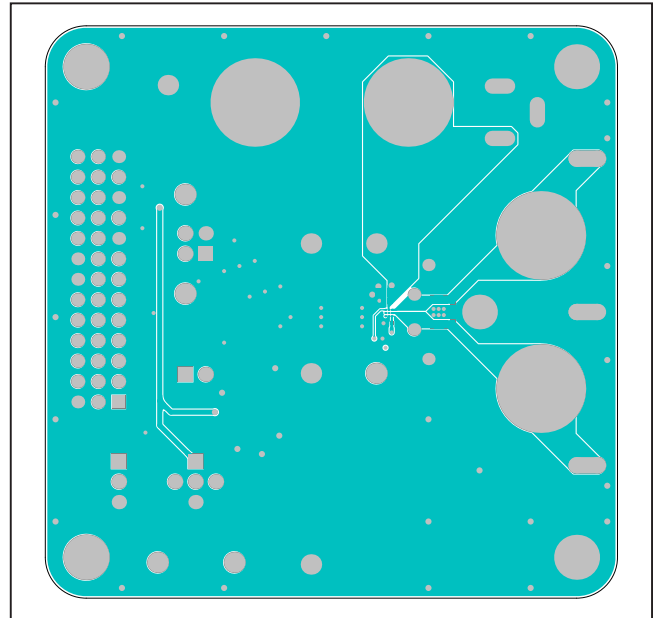

MAX98363C/MAX98363D Dev Board PCB Layout—Top Layer

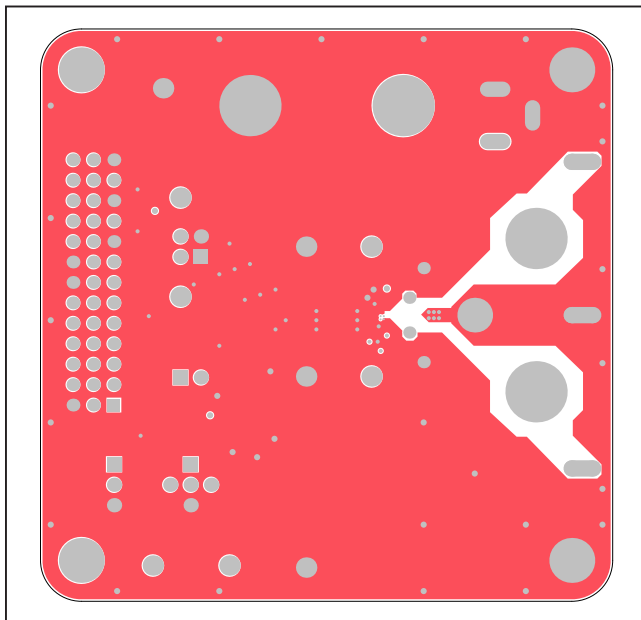

MAX98363C/MAX98363D Dev Board PCB Layout—Layer 2

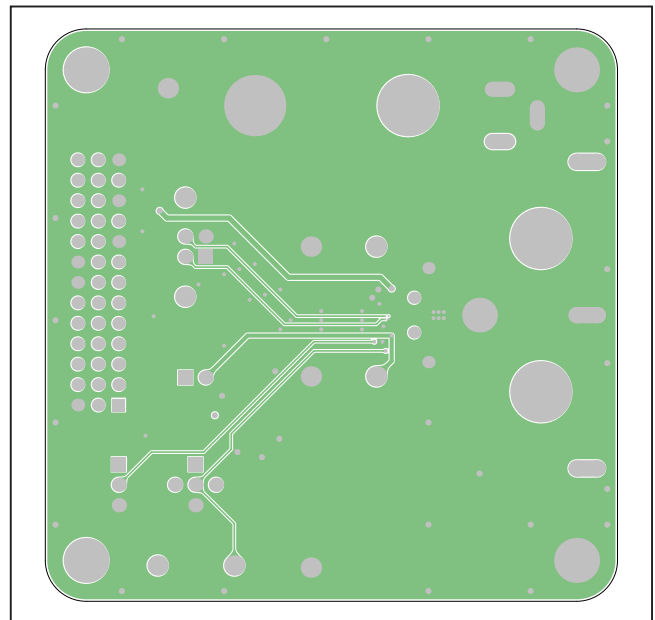

MAX98363C/MAX98363D Dev Board PCB Layout—Layer 3

MAX98363C/MAX98363D WLP Development Board PCB Layout Diagrams (continued)

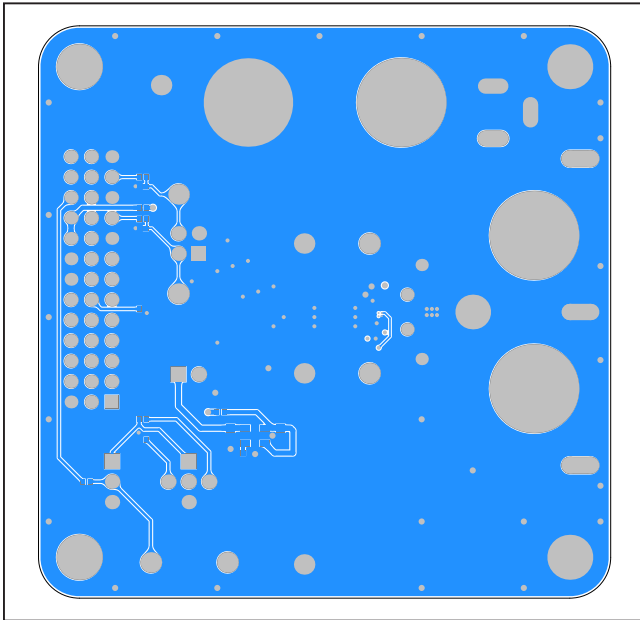

MAX98363C/MAX98363D Dev Board PCB Layout—Bottom Layer

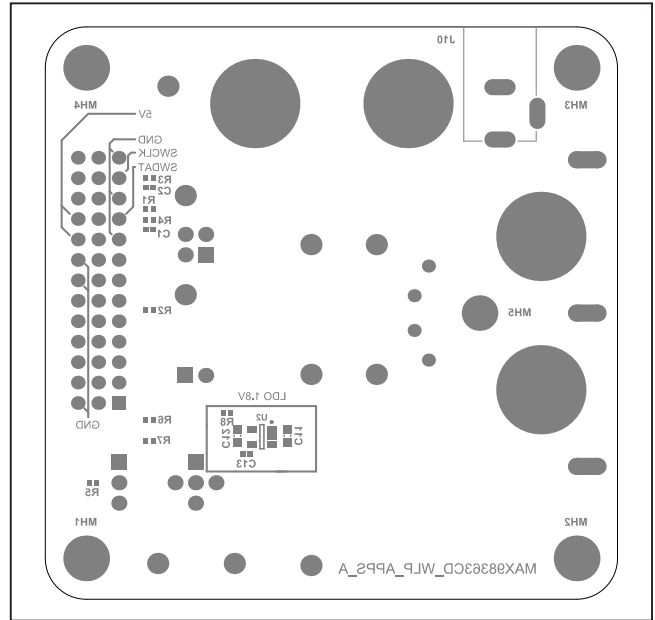

MAX98363C/MAX98363D Dev Board Component Placement Guide—Bottom Silkscreen

### Revision History

REVISION NUMBER	REVISION DATE	DESCRIPTION	PAGES CHANGED
0	12/22	Initial release	—

