

General Description

The MAX22196 evaluation kit (EV kit) provides the hardware and software necessary to evaluate the MAX22194 and MAX22196, Quad and Octal Industrial Sink/Source Digital Input devices. The MAX22196 EV kit receives commands from a PC through the USB port and creates SPI transactions for communication between the software and the MAX22194 or MAX22196 on the EV kit. The MAX22196 EV kit also has a Pmod™-compatible connector for SPI communication with an external host device such as a microcontroller unit (MCU) or field-programmable gate array (FPGA).

The EV kit comes with a MAX22196ATJ+ in a 5mm x 5mm 32-pin TQFN package, installed as U1. The EV kit can also be used to evaluate the MAX22194ATJ+. To do so, order MAX22194ATJ+ samples and replace U1 on the board.

The EV kit includes a GUI that provides communication between the target device and the PC. The GUI allows configuration and reading of the MAX22194/MAX22196 status through SPI. All input channels of the MAX22194/MAX22196 can individually be configured as sinking or sourcing type. Each channel also supports Type 1/3, Type 2, TTL or HTL input with the current limit set by a single on-board resistor. The MAX22196 EV kit is designed to support transient immunity testing for ESD, EFT, and Surge according to IEC 61000-4-2, IEC 61000-4-4, and IEC 61000-4-5, respectively. The EV kit can operate in multiple modes, as shown in the [EV Kit System Block Diagram](#):

- **USB Mode:** If SW1 are all closed, the device SPI receives commands through the USB port from the Analog Devices-supplied EV kit software.
- **Pmod Mode:** If SW1 are all open, the device SPI receives commands through the PMOD1 connector. This industry standard connector interfaces with popular MCU or FPGA platforms. User is required to generate firmware to provide the SPI commands.
- **Multi-Device Mode:** Multiple MAX22196 EV kits can be connected in daisy-chain mode using PMOD1 and PMOD2 connectors. User can choose to use the provided software GUI, which supports up to four devices in daisy chain, or their own microcontroller or FPGA platforms.

Windows and Windows XP are registered trademarks and registered service marks of Microsoft Corporation. Pmod is a trademark of Digilent, Inc.

Features and Benefits

- Easy Evaluation of the MAX22194 or MAX22196
- EV Kit Logic Side is USB-Powered
- Software Configurable for IEC 61131-2 Type 1/3, Type 2, TTL or HTL Inputs
- Galvanic Isolation Using the MAX14483
- Supports Transient Immunity Testing According to IEC 61000-4-2, IEC 61000-4-4, and IEC 61000-4-5 Standards
- Robust Design at Field Inputs
 - ±1kV Surge Tolerant Line-to-Ground and Line-to-Line
 - ±8kV Contact Electrostatic Discharge (ESD)
 - ±15kV Air-Gap ESD
- Windows® 10 Compatible Software
- Fully Assembled and Tested
- Proven PCB Layout
- RoHS Compliant

EV Kit Contents

- MAX22196EVKIT# including the MAX22196ATJ+
- Micro-USB cable
- 24V power adapter

EV Kit Photo

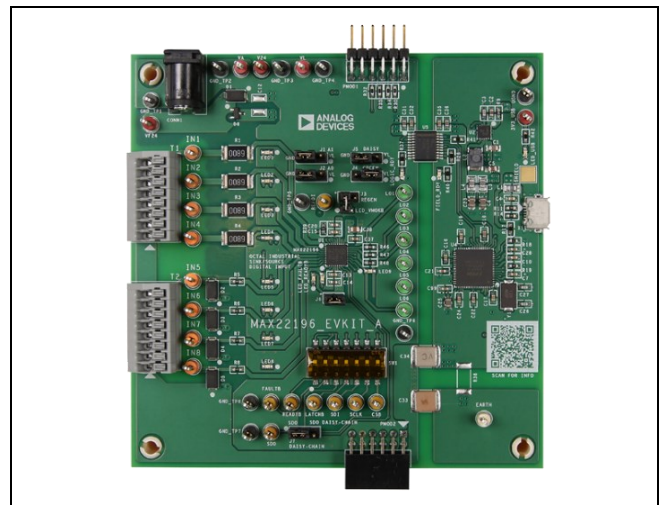

[Ordering Information](#) appears at end of data sheet.

MAX22196 EV Kit Files

FILE	DESCRIPTION
MAX22196EVKitSetupV1.00.exe	Installs EV kit software onto computer

Quick Start

Required Equipment

- MAX22196 EV kit
- Micro-USB cable
- 24V DC voltage supply (or 24V AC-DC adapter with barrel connector)
- Source meter
- Windows 10, Windows® 8.1, Windows® 7, Window XP® PC with a spare USB port

Note: In the following sections, software-related items are identified by bolding. Text in **bold** refers to items directly from the EV kit software. Text in **bold and underlined** refers to items from the Windows operating system.

Procedure

The EV kit is fully assembled and tested. The default jumper settings configure the EV kit to operate in USB mode. In this configuration, the EV kit’s “logic side” is powered by +5V from the X1 USB connector, the “field side” is powered by the external DC supply connected to the VF24 and GND test points (or CONN1 barrel connector). The MAX22196 is configured in addressable SPI mode with address of 00. Terminal blocks T1 and T2 provide access to all eight channels, which can be configured to Type 1/3 or Type 2, sink or source digital inputs by the EV kit software. Follow the steps to verify the MAX22196 operation:

1. Verify that all jumper settings are in the default position from Table 1.
2. For initial testing, the MAX22196 EV kit is powered from USB connector (+5V), and 24V at the VF24 and GND test points.

EV Kit System Block Diagram

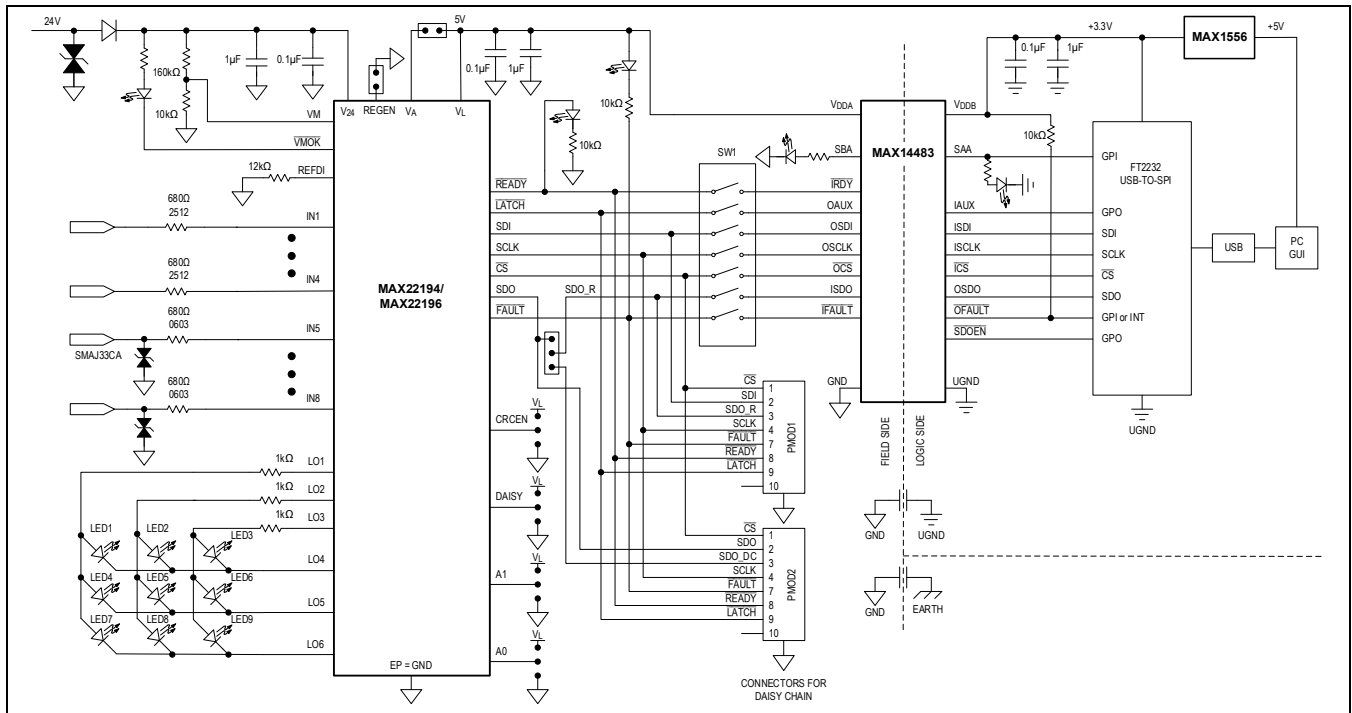

3. Visit <http://www.analog.com> to download the latest version of the EV kit software, MAX22196EVKitSetupV1.00.exe.
4. Install the EV kit software and USB driver on your computer by running the MAX22196EVKitSetupV1.00.exe program. A message box asking "Do you want to allow the following program to make changes to this computer?" might appear. If so, click **Yes**.
5. The program files are copied to your PC and icons are created in the Windows **Start | Programs** menu. At the end of the installation process, the .NET framework 4.0 and FTDI Chip CDM drivers are launched by the installer.
6. The installer includes the drivers for the hardware and software. Follow the instructions on the installer and once complete, click **Finish**. The default location of the software is in the program files directory.
7. Connect the MAX22196 EV kit USB connector X1 to the PC with the micro-USB cable. Windows should automatically recognize the device and display a message near the **System Icon** menu indicating that the hardware is ready to use. Observe that LED_USB (yellow) is turned on.
8. Connect the DC power supply between the EV kit's VF24 and GND_TP1 test points. Set the DC power supply output to 24V and then enable the output. On the EV kit, observe that the LED_FAULTB (red), LED_VMOKB (green), LOGIC_RDY (yellow), and FIELD_RDY (yellow) LEDs are turned on, indicating that the EV kit is powered up.
9. Once the hardware is ready to use, launch the EV kit software by opening its icon in the **Start | Programs** menu. During the EV kit software launch, two message boxes are shown to indicate that the address bits A1 and A0 setting in the software should match the A1 and A0 address pins on the board. The CRC enable setting in the software should match the CRCEN pin on the board. Click **OK** to close the message box. The EV kit software appears as shown in [Figure 1](#).
10. The default SPI address should be **A1:A0 = 00**. The **CRC Enable** should be enabled, and **Daisy Chain Enable** should be disabled by default. If **SPI Address (A1:A0)**, **CRC Enable** and **Daisy Chain Enable** settings are different, update the dropdown list control and checkbox controls on the right. Click **OK** to close message boxes when making the changes.
11. Verify that the lower-right status bar indicates the EV kit hardware is **Connected**. If the status bar indicates **Disconnected**, click **Connect to Hardware** from the **Device** menu. Next, select a device in the list or use the default device already selected.
12. Observe that after the GUI is launched and connected on the software, none of the faults are on, and both FAULTB signal and READY signal are green at right-hand side. On the EV kit hardware, observe that LED_FAULTB (red) LED is turned off.

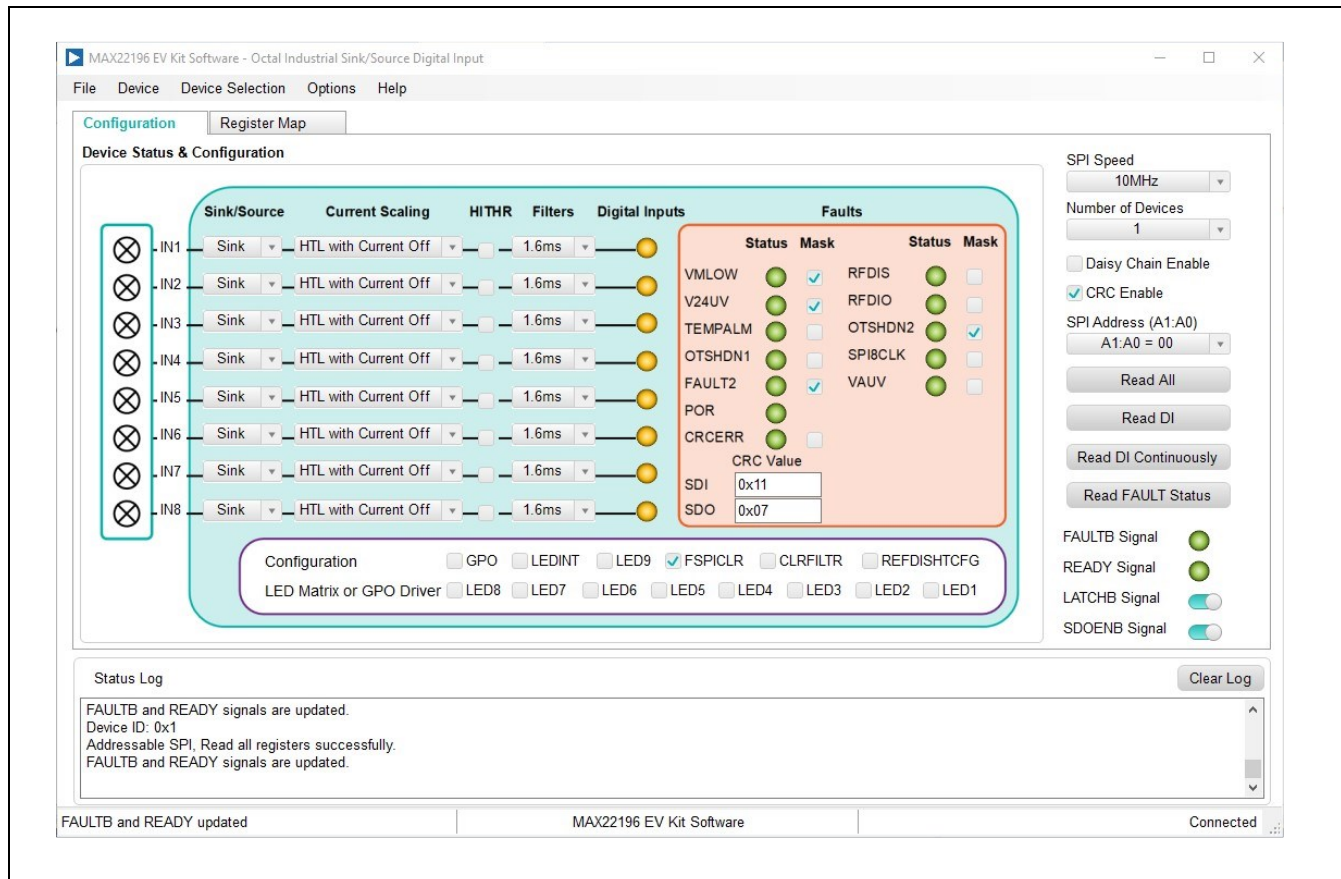

Figure 1. MAX22196 EV Kit Software Startup Window

13. Configure all channels to Type 1/3 Sink mode and display the per-channel digital input status on the LED1 to LED8. Configure all channels' **Sink/Source** dropdown box to **Sink** mode, **Current Scaling** box to **1x Current**, and **HITHR** checkbox to be enabled as shown in [Figure 2](#). The **LEDINT** checkbox is enabled to allow LED matrix to be controlled autonomously by the device. Once the configuration is done, click **Read DI Continuously**. The EV kit software now reads the DISTATE register continuously.

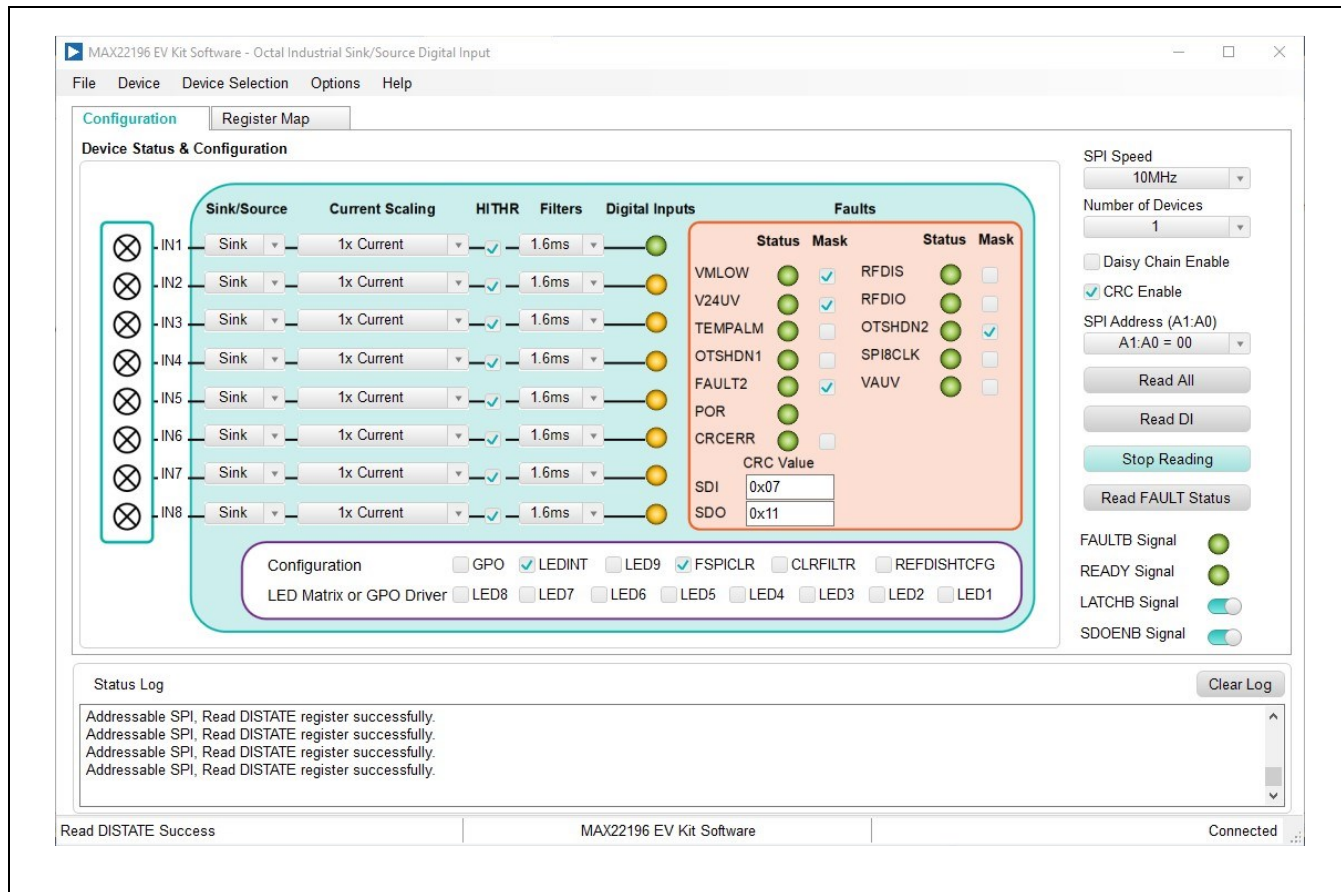

Figure 2. MAX22196 EV Kit Software—Type 1/3 Sink Mode Configuration

14. Connect the positive terminal of the source meter to test point IN1. Connect the negative terminal of the source meter to test point GND_TP2 on the MAX22196 EV kit. Set the source meter to voltage output and measure the current. Set the voltage output to 24V and enable the source meter. Verify that:
 - The measured current is about 2.25mA typical.
 - On the EV kit hardware, LED1 (green) is on.
 - On the EV kit software, **IN1** light in **Digital Inputs** column is green.
15. Repeat Step 14 by connecting the 24V to IN2 to IN8 test points. Verify that every channel is operating in Type 1/3 sink mode. Click **Stop Reading** to stop the register polling and disable the source meter output once test is done. Note when U1 is installed with the MAX22194, IN5 to IN8 test points are connected to the I.C. pins of the MAX22194. Leave IN5 to IN8 unconnected.
16. Configure all channels to Type 2 Source mode. Configure all channels' **Sink/Source** dropdown box to **Source** mode, **Current Scaling** box to **3x Current**, and **HITHR** checkbox to be disabled as shown in [Figure 3](#). Once the configuration is done, click **Read DI Continuously**. The EV kit software now reads the DISTATE register continuously.
17. Connect the positive terminal of the source meter to test point IN1. Connect the negative terminal of the source meter to test point GND_TP2 on the MAX22196 EV kit. Set the source meter to voltage output and measure the current. Set the voltage output to 5V. Verify that:
 - The measured current is about -6.7mA typical.
 - On the EV kit hardware, LED1 (green) is on.
 - On the EV kit software, **IN1** light in Digital Inputs column is green.

18. Repeat Step 17 by connecting the 5V to IN2 to IN8 test points. Verify that every channel is operating in Type 2 source mode. Click **Stop Reading** to stop the register polling and disable the source meter output once test is done. Note when U1 is installed with the MAX22194, IN5 to IN8 test points are connected to the I.C. pins of the MAX22194. Leave IN5 to IN8 unconnected.

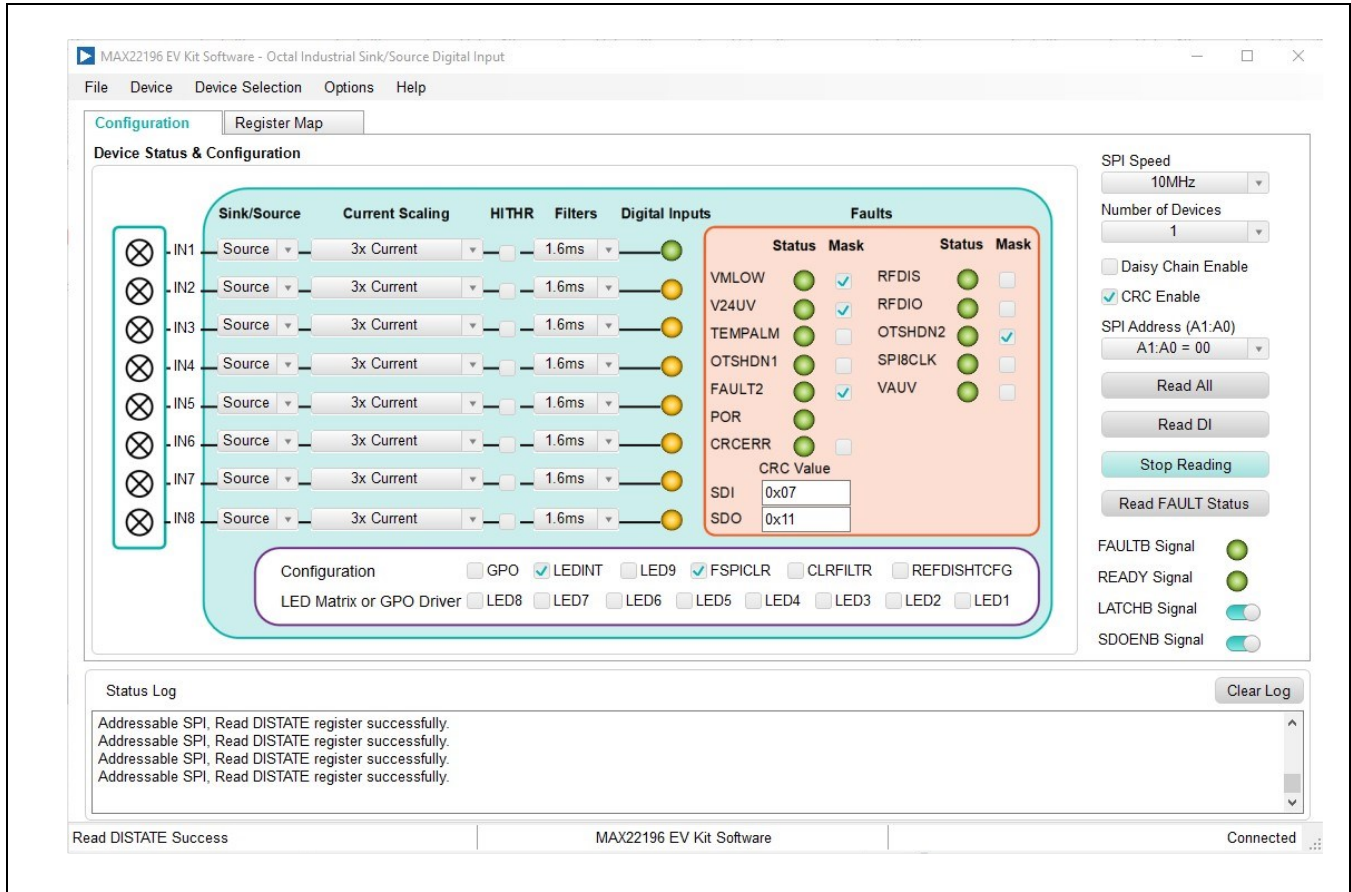

Figure 3. MAX22196 EV Kit Software—Type 2 Source Mode Configuration

Table 1. MAX22196 EV Kit Jumper Settings

JUMPER	SHUNT POSITION	DESCRIPTION
J1	1–2	Connect address pin A1 to V_L , A1 = 1
	2–3*	Connect address pin A1 to GND, A1 = 0
J2	1–2	Connect address pin A0 to V_L , A0 = 1
	2–3*	Connect address pin A0 to GND, A0 = 0
J3	1–2	Connect REGEN pin to GND. When REGEN is connected to GND, the internal V_A regulator is disabled, apply an external 3V to 5.5V supply to VA test point.
	Open*	Leave REGEN open. The internal V_A regulator is enabled. The V_A is 5V linear regulator.
J4	1–2*	Connect CRCEN pin to V_L . CRC generation and error detection on the SPI is enabled.

	2–3	Connect CRCEN pin to GND. CRC generation and error detection on the SPI is disabled.
J5	1–2	Connect DAISY pin to V_L to operate in the daisy-chain SPI mode.
	2–3*	Connect DAISY pin to GND to operate in the addressable SPI mode.
J6	1–2*	Connect V_A supply to V_L supply.
	Open	Connect external power supply from VL test point to V_L supply.
J7	1–2*	Connect the MAX22196 SDO signal to the ISDO input of the digital isolator, the MAX14483. This option is used when the EV kit is operating in standalone mode, or the EV kit is the last device in the daisy chain when operating in daisy-chain mode.
	2–3	Connect the SDO signal from the next device in the daisy chain, SDO_DC on the PMOD2 connector, to the SDO_R signal on the PMOD1 connector so that the SDO signal from the last device in the daisy chain can be passed to the first device in the daisy chain and be connected to the digital isolator MAX14483 ISDO input. This option is used when the EV kit is operating in daisy-chain mode and is not the last device in the daisy chain.
SW1	On*	All switches on SW1 are closed. The MAX22196 logic signals \overline{CS} , SCLK, SDI, SDO, \overline{LATCH} , \overline{FAULT} , and \overline{READY} are connected to the MAX14483 isolator. This option is used when the EV kit is operating in standalone mode, or the EV kit is the first device in the daisy chain.
	Off	All switches on SW1 are open. The MAX22196 logic signals \overline{CS} , SCLK, SDI, SDO, \overline{LATCH} , \overline{FAULT} , and \overline{READY} are disconnected from the MAX14483 isolator. This option is used when the EV kit is operating in daisy-chain mode and is not the first device in the daisy chain.

*Default Position

Table 2. MAX22196 EV Kit Test Point and Connector Description

ITEM	DESCRIPTION
TEST POINTS	
VF24 (RED)	External field supply input for the MAX22196 EV kit. Connect +24V DC between VF24 and GND_TP1 test points.
V24 (RED)	Field-side supply input for the MAX22196 V_{24} . Protected by reverse polarity diode D6.
VA (RED)	Field-side analog supply for the MAX22196 V_A . +5V when powered by the MAX22196 internal LDO with jumper J3 (REGEN) open.
VL (RED)	Field-side logic supply for the MAX22196 V_L . Can be connected to the MAX22196 V_A by closing jumper J6.
IN1 to IN8 (ORANGE)	Field-side digital inputs for the MAX22196 IN1 to IN8. When U1 is installed with the MAX22194, IN5 to IN8 test points are connected to the IC pins on the MAX22194. Leave IN5 to IN8 test points unconnected.
REFDI (BROWN)	MAX22196 REFDI signal
LO0 to LO6 (GREEN)	MAX22196 LO1 to LO6 signal
FAULTB (BROWN)	MAX22196 \overline{FAULT} signal
READYB (BROWN)	MAX22196 \overline{READY} signal
LATCHB (BROWN)	MAX22196 \overline{LATCH} signal
CSB (BROWN)	MAX22196 \overline{CS} signal
SCLK (BROWN)	MAX22196 SCLK signal
SDI (BROWN)	MAX22196 SDI signal
SDO (BROWN)	MAX22196 SDO signal

GND_TP1 to GND_TP8 (BLACK)	Field-side ground
3V3_USB (RED)	Logic-side +3.3V supply
UGND (BLACK)	Logic-side ground
CONNECTORS	
T1	Terminal block for the MAX22196 digital inputs IN1 to IN4. Pin 8 is connected to IN1, pin 6 is connected to IN2, pin 4 is connected to IN3, and pin 2 is connected to IN4. Pins 1, 3, 5, 7 are field-side ground.
T2	Terminal block for the MAX22196 digital inputs IN5 to IN8. Pin 8 is connected to IN5, pin 6 is connected to IN6, pin 4 is connected to IN7, and pin 2 is connected to IN8. Pins 1, 3, 5, 7 are field-side ground. When U1 is installed with the MAX22194, IN5 to IN8 are connected to the IC pins on the MAX22194. Leave IN5 to IN8 unconnected.
PMOD1	The 12-pin Pmod-compatible male connector to allow external microcontroller or FPGA to configure the MAX22196. It can also be used in daisy-chain mode by connecting to the PMOD2 connector of another MAX22196 EV kit.
PMOD2	The 12-pin Pmod-compatible female connector to be used in daisy-chain mode by connecting to the PMOD1 connector of another MAX22196 EV kit.
CONN1	Barrel connector with positive center polarity as the EV kit main power supply. Connect +24V DC to CONN1 or between VF24 and GND_TP1 test points.
X1	Micro-USB connector to connect the MAX22196 EV kit to a PC USB port

Detailed Description of Hardware

The MAX22196 EV kit provides a proven design for a galvanically isolated configurable Type 1/3 or Type 2 sink or source digital input solution using the MAX22194 or MAX22196 and the MAX14483.

Power Supplies

The EV kit has two power domains, the “logic side” which is powered from USB-supplied power (3V3_USB and UGND), and the “field side” which is typically powered from an external 24V DC supply connected to the VF24 and GND test points. A MAX1556 DC-DC converter converts the +5V USB supply to a regulated +3.3V (3V3_USB) supply, which powers the EV kit logic side.

When REGEN is open (J3 is open), the MAX22196 has integrated regulator enabled to provide low voltage output V_A (5V, nominal), which is used to set the SPI logic interface level (V_L) and to power the field side of the digital isolator if J6 is in 1–2 position (see [Table 1](#)). When REGEN is connected to ground (J3 in 1–2 position), the MAX22196 analog supply V_A is powered externally by applying an external 3.0V to 5.5V supply through the VA and GND test points. Note that V_{24} supply should still be applied if operating the device in source mode. In sink and TTL modes, external 24V on V_{24} is not necessary.

In the case that an external microcontroller is used on the PMOD1 connector (SW1 contacts all open), the logic supply (V_L) of the MAX22196 is provided by an external microcontroller supply. Remove jumper J6 (see [Table 1](#)), connect a 2.5V to 5.5V external supply to pins 6 and 12 on the PMOD1 connector, and populate R20 with a 0 Ω resistor.

Digital Inputs and Surge Protection

The MAX22196 senses the logic state of eight digital inputs. The voltages at the IN1 to IN8 input pins are compared against internal references to determine whether the field input is high (logic 1) or low (logic 0). Each input can be individually configured for current sinking or sourcing, Type 1/3 or Type 2 DI, 5V TTL or 24V HTL operation.

The REFDI resistor R39 (12k Ω) and input resistors R1 to R8 (680 Ω) ensure that the current at the ON and OFF trip points as well as the voltage at the trip points satisfy the requirements of IEC 61131-2 Type 1/3 or Type 2 digital inputs.

Channels 1 to 4 and channels 5 to 8 demonstrate two options for surge protection on the MAX22196 field inputs. On channels 1 to 4, the input resistors R1 to R4 are 680 Ω , 1.5W pulse withstanding thick film 2512 resistors to support IEC 61000-4-5 surge tolerance at ± 1 kV line-to-ground without the requirements for an external TVS diode on each input. On channels 5 to 8, the input resistors R5 to R8 are 680 Ω , 0.1W 0603 resistors with an SMAJ33CA TVS diode (D2 to D5) on each field input. Both options support IEC 61000-4-5 1.2 μ s/50 μ s surges of up to ± 1 kV line-to-ground with 42 Ω + 0.5 μ F CDN.

When U1 is installed with the MAX22194, the IN5 to IN8 inputs are connected to the IC pins of the MAX22194. Leave IN5 to IN8 inputs unconnected. The IN1 to IN4 inputs have the same functionalities as the MAX22196 inputs.

LED Matrix

The MAX22196 features six logic output pins (LO1 to LO6) that can be configured as six general-purpose push-pull logic outputs (GPO) or as a 3 x 3 LED driver crossbar matrix. When configured in the GPO mode, LO1 to LO6 outputs can be accessed by LO1 to LO6 test points (see [Table 2](#)), and LED1 to LED9 status are don't care. When configured in the LED matrix mode, LED1 to LED9 demonstrate LED matrix operation as shown in the [EV Kit System Block Diagram](#). When the LED matrix is in the autonomous mode, LED1 to LED8 indicate per input channel status hence they are located next to their respective input channels. LED9 indicates the status of V_M comparator.

When U1 is installed with the MAX22194, and the device is configured in the LED matrix mode, LED1 to LED4 demonstrate the same LED matrix operation as in the MAX22196, and LED5 to LED9 are don't care. When the device is configured in the GPO mode, LO1 to LO6 are GPOs.

SPI Interface

The EV kit software communicates over USB to the SPI and supports full 12MHz clock rate for the MAX22196. The EV kit includes a standard Pmod-compatible 12-pin header (PMOD1) to connect to an external adapter board (MCU or FPGA). If the user wants to interface to their own microcontroller or FPGA, simply connect to the Pmod connector PMOD1, open all SW1 switches, and provide the user-supplied firmware.

Daisy-Chain Operation with Multiple MAX22196EVKIT#

The MAX22196 EV kit can operate as a standalone device or be daisy-chained with other MAX22196 EV kits using PMOD1 and PMOD2 connectors. The MAX22196 EV kit software supports up to four devices in a daisy chain, but the device itself can support more.

The first device in the daisy chain (Device 1) communicates to a PC through a USB interface. The PMOD2 connector on the Device 1 EV kit connects to the PMOD1 connector on the Device 2 EV kit. In this way, \overline{CS} , SCLK, \overline{FAULT} , \overline{READY} , and \overline{LATCH} signals of the devices in the daisy chain are shorted, respectively. The SDO of the Device 1, routed on PMOD2 pin 2, is connected to the SDI of the Device 2, routed on PMOD1 pin 2. Pin 3 of PMOD1 and PMOD2 are used to route the SDO of the last device in the chain back to the first device, which communicates with the SPI controller, i.e., FT232 USB-to-SPI bridge. See the [MAX22196 EV Kit Schematic](#) for details.

On the Device 1 EV kit, close all switches on SW1 in order to allow the MAX22196 EV kit software communicating with all devices in the daisy chain using Device 1 EV kit USB-to-SPI bridge. On all trailing EV kits, open all switches on SW1 to disconnect the MAX22196 SPI from their own USB-to-SPI bridge, preventing any bus contention. To allow the SDO of the last device in the chain connected back to the first device, jumper J7 is set to 1–2 position for the last device in the daisy chain and it is set to 2–3 position for the other devices in the chain. Jumper J5 (DAISY) is set to 1–2 position for all devices in the daisy chain to enable SPI daisy-chain mode.

Galvanic Isolation

The MAX22196 EV kit uses a digital isolator to provide galvanic isolation between the logic and field sides. The MAX14483 is a six-channel digital isolator, providing a single-chip solution when interfacing to the MAX22196. The isolator has two power supplies (V_{DDA} and V_{ddb}) which operate between 1.71V to 5.5V and provide voltage translation as well as galvanic isolation. The “logic side” V_{ddb} of the isolator is powered from 3V3_USB and UGND while the “field side” V_{DDA} of the isolator is powered from V_L and GND. When testing isolation performance, care should be taken not to have a multi-channel oscilloscope ground connection to both GND and UGND.

Protective Earth (PE) is provided on the lower-right corner of the EV kit with safety-rated Y capacitors between field ground (GND) and PE (C33), and between GND and logic ground (UGND) (C34) to improve the high-voltage, fast transient performance.

IEC 61000-4 Transient Immunity Compliance

The typical application for the MAX22196 requires it to pass basic transient immunity standards as defined by IEC 61000-4-x, covering -2 for ESD, -4 for Electrical Fast Transient/Burst (EFT), and -5 for Surge Immunity. The MAX22196 EV kit includes circuitry to support testing to these standards to support ± 1 kV line-to-ground and line-to-line surge, ± 8 kV contact ESD, and ± 15 kV air-gap ESD at the field input. The TVS diode (D1) provides protection from surge and ESD voltages applied through the VF24 test point. Diode D6 blocks the reverse current at the V_{24} pin of the MAX22196 during negative surges. To achieve the best surge performance on the field input, place a minimum 680 Ω pulse-withstanding resistor between the field input and the device input pin. C33 is a 3300pF safety-rated Y capacitor placed between PE and GND to improve transient immunity (EFT). C34 is a 1000pF safety-rated Y capacitor connected between the GND and UGND to enhance the isolation barrier robustness. For systems where PE and UGND are bonded together, the user can install resistor R38.

Detailed Description of Software

When the MAX22196 EV kit software starts, it automatically detects if the EV kit is connected to a PC and indicates its status in the status bar at the bottom edge of the GUI. If the software does not recognize the EV kit board, make sure that the software and all drivers are properly installed, check the USB connection, and go to the **Device** menu and select the **Search for Hardware** option. When the EV kit is properly connected, the MAX22196 device is read and all controls are updated (see [Figure 1](#)).

The main window of the EV kit software contains two groups of controls: **Configuration** and **Register Map** tabs, and general controls for the EV kit. The **Configuration** tab provides the controls to directly configure the MAX22196 features such as configuring the input channel mode, reading digital inputs, input filter configuration, fault status reporting, etc. The general controls for the EV kit allow the user to select the SCLK speed, SPI address, CRC enable, \overline{LATCH} operation, etc. Next to the **Configuration** tab, the **Register Map** tab lists all registers in the MAX22196 and provides direct read and write access to all control bits.

If the MAX22196EVKIT# hardware is not connected automatically, the **Device** menu provides the functionality to connect to or disconnect from the hardware by choosing detected EV kit serial numbers. Under the **Options** menu, a **CRC Calculator** (see [Figure 4](#)) is provided to calculate the 5-bit CRC code based on the data frame provided by the user. The jumper positions are shown in the **Jumper Setting Diagram** (see [Figure 5](#)) under the **Options** menu based on SPI operation modes.

Configuration Tab

The **Configuration** tab provides an interface for configuring the MAX22196 from a functional perspective. Before sending the commands to the MAX22196, select the desired SPI mode and configure the jumpers according to [Table 1](#). The tab provides controls for per-channel mode selection, input filter configuration, fault status reporting, LED matrix configuration, CRC value calculation, etc.

After power up, the MAX22196 $\overline{\text{FAULT}}$ pin is low, the POR and FAULT2 bits in the FAULT1 register and the VAUV bit in the FAULT2 register are set, indicating that a power-on-reset has occurred and all registers are set to default. Upon launching the MAX22196 EV kit software, all registers are read twice to clear latched faults and retrieve the latest register values. If the device operates normally, all faults are cleared as shown in [Figure 1](#) and FAULTB LED is turned off.

The **Read All** button reads the MAX22196 registers and refreshes all the controls with current setting. The **Read DI** and **Read DI Continuously** buttons read the DISTATE register, along with the six diagnostic bits on the SDO, and update the corresponding controls. The **Read FAULT Status** button reads the FAULT1 and FAULT2 registers and updates the corresponding fault status in the **Configuration** tab.

Daisy-Chain Operation

The EV kit software supports up to four devices in the daisy-chain mode. By default, the software operates in addressable SPI mode and communicates with only one device, which is indicated by allowing only “**Device 1**” in the **Device Selection** menu. In the addressable SPI mode, **Daisy Chain Enable** checkbox is not selected and jumper J5 (DAISY) is in 2–3 position. Choose the SPI address in the **SPI Address (A1:A0)** dropdown box to match the A1 and A0 pin settings, configured by J1 and J2 jumpers.

In the daisy-chain mode, **Daisy Chain Enable** checkbox is selected and jumper J5 (DAISY) is in 1–2 position. Based on the location of the EV kit in the chain, J7 on all the EV kits should be configured properly to route the last device’s SDO back to the first EV kit in the chain, which communicates with the EV kit software through the USB. See the [Daisy-Chain Operation with Multiple MAX22196EVKIT#](#) section for hardware configuration.

When more than two devices are connected in daisy-chain mode, select the number of devices in the chain by changing the **Number of Devices** dropdown box. Up to four devices are supported by the software. The **Device Selection** menu is updated with all device numbers when **Number of Devices** selection is changed. Select which device to communicate with in the **Device Selection** menu, and then the **Configuration** and **Register Map** tabs are updated to show the selected device’s register content. The EV kit software only sends commands to the specified device. The software maintains all four devices’ register contents in the PC memory.

CRC Calculator

Clicking **CRC Calculator** under the **Options** menu opens the CRC calculation window (see [Figure 4](#)). The software calculates the 5-bit CRC code based on the 16-bit data and displays the result.

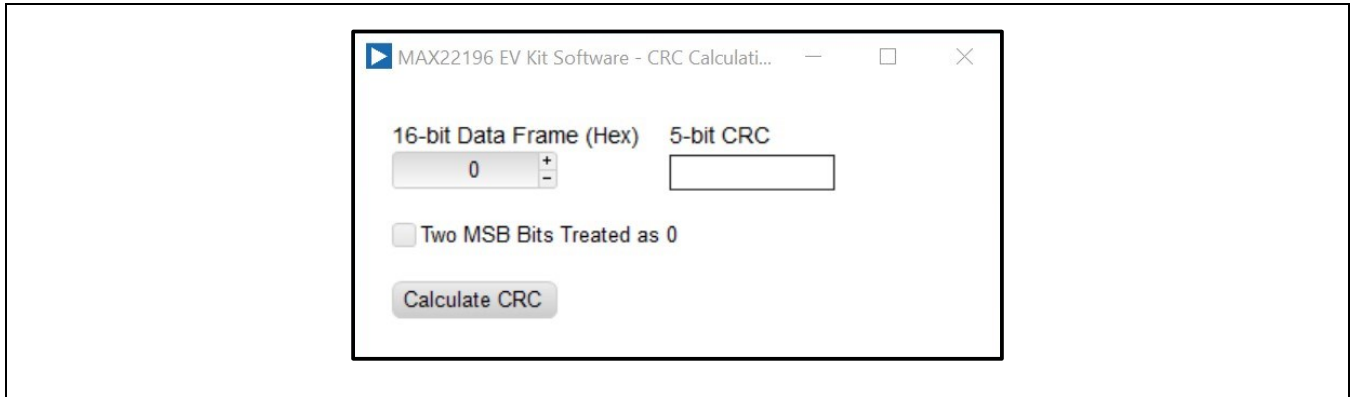

Figure 4. MAX22196 EV Kit Software—CRC Calculator

Jumper Setting Diagram

Clicking **Jumper Setting Diagram** under the **Options** menu opens the jumper setting window (see [Figure 5](#)). The software displays the jumper positions based on the current device operation mode in the top silkscreen diagram. Changing the SPI configuration updates the shunt positions in the diagram. In the addressable SPI mode, jumpers J1 and J2 are updated to match the address configured in the **SPI Address (A1:A0)** dropdown box. In the daisy-chain mode, jumper J7 should be updated based on the EV kit location in the chain. Connect J7 in 1–2 location when the EV kit is the last device in the chain and connect J7 in 2–3 location when the EV kit is one of the first devices in the chain. Note that the EV kit software supports up to four devices in the chain.

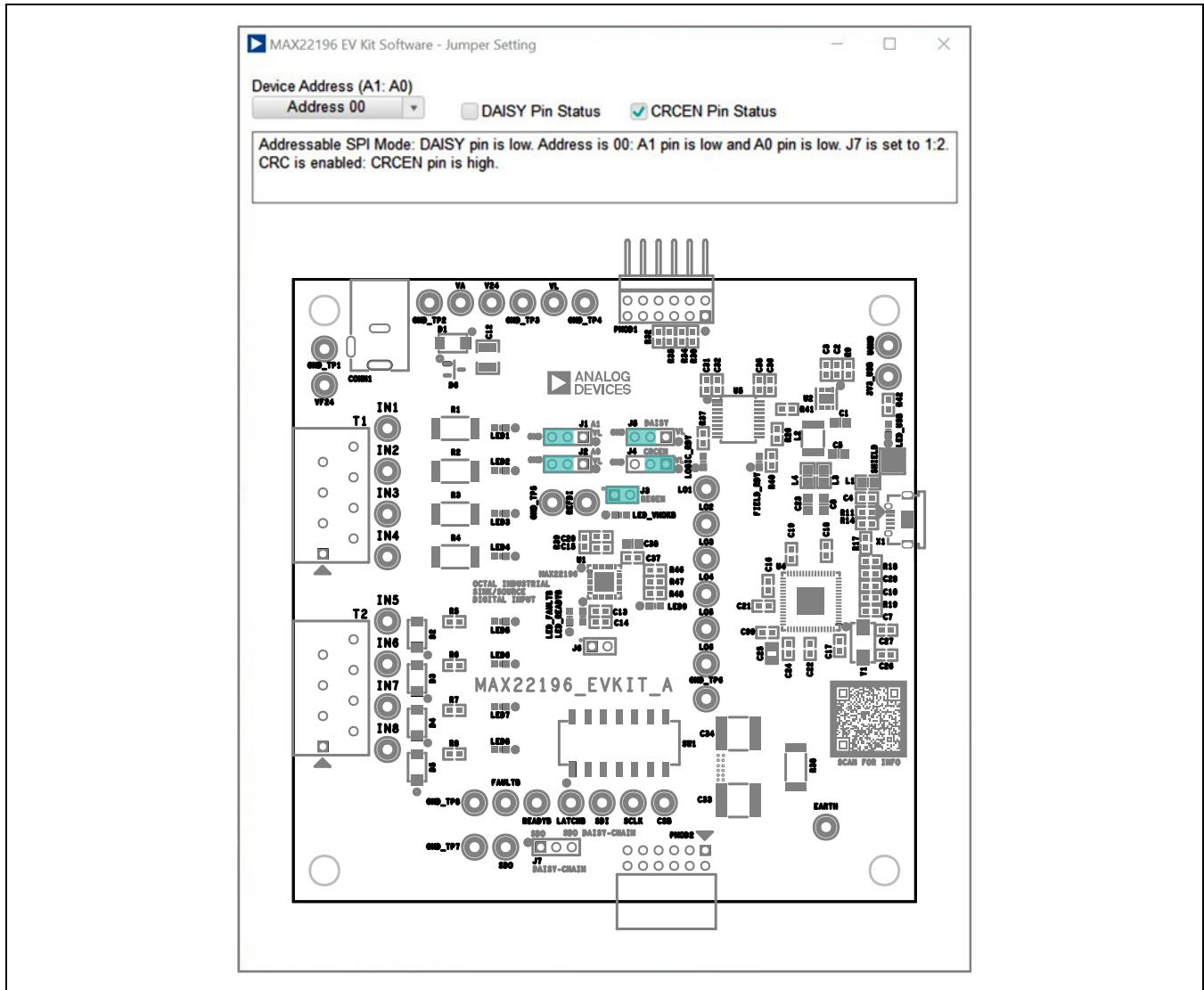

Figure 5. MAX22196 EV Kit Software—Jumper Setting Diagram

Register Map

The **Register Map** tab shows all MAX22196 registers information including the register name, address, value, read or write accessibility, and the register description. The **Value** cell can be changed by the user if the register is writable. Pressing the **Enter** key after changing the **Value** writes to the register. When a certain register is highlighted in the register list, the bits' information in this register is displayed in the **Bits Description** table. The bit **Setting** is configurable if the bit is writable, which triggers a write operation to its register.

Clicking **Read All** reads all registers and refreshes the window with current register values. Clicking **Write All** writes the current settings to all registers.

Ordering Information

PART	TYPE
MAX22196EVKIT#	EV Kit

#Denotes RoHS compliance.

Note: MAX22196EVKIT# comes with MAX22196ATJ+. To evaluate the MAX22194ATJ+, request samples separate to the EV kit.

MAX22196 EV Kit Bill of Materials

ITEM	REF_DES	DNI/DNP	QTY	MFG PART #	MANUFACTURER	VALUE	DESCRIPTION
1	3V3_USB, V24, VA, VF24, VL	-	5	5010	KEYSTONE	N/A	TEST POINT; PIN DIA=0.125IN; TOTAL LENGTH=0.445IN; BOARD HOLE=0.063IN; RED; PHOSPHOR BRONZE WIRE SIL;
2	C1, C9, C29	-	3	CL21B106KOQNNN; GRM21BZ71C106KE15; GMC21X7R106K16NT	SAMSUNG; MURATA; CAL-CHIP	10µF	CAP; SMT (0805); 10µF; 10%; 16V; X7R; CERAMIC
3	C2	-	1	C1608X7R1H474K080AC	TDK	0.47µF	CAP; SMT (0603); 0.47µF; 10%; 50V; X7R; CERAMIC
4	C3	-	1	C1608C0G2A102J080AA; C0603C102J1GAC	TDK;KEMET	1000PF	CAP; SMT (0603); 1000PF; 5%; 100V; C0G; CERAMIC
5	C4	-	1	C0603C103K2RAC	KEMET	0.01µF	CAP; SMT (0603); 0.01µF; 10%; 200V; X7R; CERAMIC
6	C5	-	1	C2012X5R1C226K125AC	TDK	22µF	CAP; SMT (0805); 22µF; 10%; 16V; X5R; CERAMIC
7	C6, C7, C10, C11, C13, C15-C19, C21, C22, C24, C28, C30, C32, C35, C37, C99	-	19	CC0603KRX7R0BB104; GRM188R72A104KA35; HMK107B7104KA; 06031C104KAT2A; GRM188R72A104K	YAGEO; MURATA; TAIYO YUDEN; AVX; MURATA	0.1µF	CAP; SMT (0603); 0.1µF; 10%; 100V; X7R; CERAMIC
8	C8, C23, C25	-	3	TMK212AB7475K; C2012X7R1E475K125AB; GRM21BZ71E475KE15	TAIYO YUDEN; TDK; MURATA	4.7µF	CAP; SMT (0805); 4.7µF; 10%; 25V; X7R; CERAMIC
9	C14, C20, C31, C36	-	4	UMK107AB7105KA; CC0603KRX7R9BB105	TAIYO YUDEN; YAGEO	1µF	CAP; SMT (0603); 1µF; 10%; 50V; X7R; CERAMIC
10	C26, C27	-	2	C0603C0G500-180JNE; C1608C0G1H180J080AA; GRM1885C1H180J	VENKEL LTD.; TDK; MURATA	18PF	CAP; SMT (0603); 18PF; 5%; 50V; C0G; CERAMIC
11	C33	-	1	VJ2220Y332KXUSTX1; GA355QR7GF332KW01	VISHAY VITRAMON; MURATA	3300PF	CAP; SMT (2220); 3300PF; 10%; 250V; X7R; CERAMIC
12	C34	-	1	VJ2220A102KXUSTX1	VISHAY VITRAMON	1000PF	CAP; SMT (2220); 1000PF; 10%; 250V; C0G; CERAMIC
13	C38	-	1	08051C105K4Z2A	AVX	1µF	CAP; SMT (0805); 1µF; 10%; 100V; X7R; CERAMIC
14	CONN1	-	1	PJ-202AH	CUI INC.	PJ-202AH	CONNECTOR; MALE; THROUGH HOLE; DC POWER JACK; RIGHT ANGLE; 3PINS
15	CSB, FAULTB, LATCHB, READYB, REFDI, SCLK, SDI, SDO	-	8	5014	KEYSTONE	N/A	TEST POINT; PIN DIA=0.125IN; TOTAL LENGTH=0.445IN; BOARD HOLE=0.063IN; YELLOW; PHOSPHOR BRONZE WIRE SILVER PLATE FINISH
16	D1-D5	-	5	SMAJ33CA	VISHAY GENERAL SEMICONDUCTOR	33V	DIODE; TVS; SMA (DO-214AC); VRM=33V; IPP=7.5A
17	D6	-	1	MMBD6050LT1G	ON SEMICONDUCTOR	MMBD605 0LT1G	DIODE; SWT; SMT (SOT-23); PIV=70V; IF=0.2A

18	EARTH	-	1	5012	KEYSTONE	N/A	TEST POINT; PIN DIA=0.125IN; TOTAL LENGTH=0.445IN; BOARD HOLE=0.063IN; WHITE; PHOSPHOR BRONZE WIRE SILVER PLATE FINISH
19	FIELD_RDY, LED_USB, LOGIC_RDY	-	3	LTST-C193KSKT-5A	LITE-ON ELECTRONICS INC.	LTST- C193KSK T-5A	DIODE; LED; YELLOW; SMT (0603); VF=2V; IF=0.005A
20	GND_TP1- GND_TP8, UGND	-	9	5011	KEYSTONE	N/A	TEST POINT; PIN DIA=0.125IN; TOTAL LENGTH=0.445IN; BOARD HOLE=0.063IN; BLACK; PHOSPHOR BRONZE WIRE SILVER PLATE FINISH
21	IN1-IN8	-	8	5013	KEYSTONE	N/A	TEST POINT; PIN DIA=0.125IN; TOTAL LENGTH=0.445IN; BOARD HOLE=0.063IN; ORANGE; PHOSPHOR BRONZE WIRE SILVER PLATE FINISH
22	J1, J2, J4, J5, J7	-	5	PCC03SAAN	SULLINS	PCC03SA AN	CONNECTOR; MALE; THROUGH HOLE; BREAKAWAY; STRAIGHT THROUGH; 3PINS; -65 DEGC TO +125 DEGC
23	J3, J6	-	2	PCC02SAAN	SULLINS	PCC02SA AN	CONNECTOR; MALE; THROUGH HOLE; BREAKAWAY; STRAIGHT THROUGH; 2PINS; -65 DEGC TO +125 DEGC
24	L1, L3, L4	-	3	BLM21PG331SN1	MURATA	330	INDUCTOR; SMT (0805); FERRITE-BEAD; 330; TOL=±25%; 1.5A
25	L2	-	1	B82432T1332K000	TDK	3.3UH	INDUCTOR; SMT (1812); FERRITE CORE; 3.3UH; TOL=±10%; 0.9A
26	LED1-LED9, LED_VMOKB	-	10	LTST-C193KGKT-5A	LITE-ON ELECTRONICS INC.	LTST- C193KGK T-5A	DIODE; LED; STANDARD; YELLOW-GREEN; SMT (0603); PIV=1.9V; IF=0.005A; -55 DEGC TO +85 DEGC
27	LED_FAULTB, LED_READYB	-	2	LTST-C193KRKT-2A	LITE-ON ELECTRONICS INC.	LTST- C193KRK T-2A	DIODE; LED; EXTRA THIN; EXTRA BRIGHT; RED; SMT (0603); VF=2.2V; IF=0.002A
28	LO1-LO6	-	6	5126	KEYSTONE	N/A	TEST POINT; PIN DIA=0.125IN; TOTAL LENGTH=0.445IN; BOARD HOLE=0.063IN; GREEN; PHOSPHOR BRONZE WIRE SILVER PLATE FINISH
29	MTH1-MTH4	-	4	9032	KEYSTONE	9032	MACHINE FABRICATED; ROUND-THRU HOLE SPACER; NO THREAD; M3.5; 5/8IN; NYLON
30	PMOD1	-	1	TSW-106-08-S-D-RA	SAMTEC	TSW-106- 08-S-D-RA	CONNECTOR; THROUGH HOLE; DOUBLE ROW; RIGHT ANGLE; 12PINS
31	PMOD2	-	1	PPPC062LJBN-RC	SULLINS ELECTRONICS CORP.	PPPC062 LJBN-RC	CONNECTOR; FEMALE; THROUGH HOLE; 0.1IN CC; HEADER; 2 ROW; RIGHT ANGLE; 12PINS

32	R1-R4	-	4	CRCW2512680RFKEGHP	VISHAY	680	RES; SMT (2512); 680; 1%; ±100PPM/DEGC; 1.5000W
33	R5-R8	-	4	CRCW0603680RFK	VISHAY DALE	680	RES; SMT (0603); 680; 1%; ±100PPM/DEGC; 0.1000W
34	R9	-	1	RC0603FR-07100RL; CR0603-FX-1000ELF	YAGEO;BOURNS	100	RES; SMT (0603); 100; 1%; ±100PPM/DEGC; 0.1000W
35	R11, R14	-	2	CRCW060310R0FK; MCR03EZPF10R0; ERJ-3EKF10R0	VISHAY; ROHM SEMICONDUCTOR; PANASONIC	10	RES; SMT (0603); 10; 1%; ±100PPM/DEGC; 0.1000W
36	R12, R13, R21-R25	-	7	CRCW06030000ZS; MCR03EZPJ000; ERJ-3GEY0R00; CR0603AJ-000ELF	VISHAY; ROHM SEMICONDUCTOR; PANASONIC; BOURNS	0	RES; SMT (0603); 0; JUMPER; JUMPER; 0.1000W
37	R15, R17, R28, R36, R41, R44	-	6	CRCW060310K0FK; ERJ-3EKF1002; AC0603FR-0710KL; RMCF0603FT10K0	VISHAY; PANASONIC;YAGEO; ZSTACKPOLE	10K	RES; SMT (0603); 10K; 1%; ±100PPM/DEGC; 0.1000W
38	R16	-	1	CRCW06032K20FK	VISHAY DALE	2.2K	RES; SMT (0603); 2.2K; 1%; ±100PPM/DEGC; 0.1000W
39	R18	-	1	CRCW060315K0FK	VISHAY DALE	15K	RES; SMT (0603); 15K; 1%; ±100PPM/DEGC; 0.1000W
40	R19, R39	-	2	CRCW060312K0FK	VISHAY DALE	12K	RES; SMT (0603); 12K; 1%; ±100PPM/DEGC; 0.1000W
41	R26	-	1	CRCW0603100KFK; RC0603FR-07100KL; RC0603FR-13100KL; ERJ-3EKF1003; AC0603FR-07100KL	VISHAY DALE;YAGEO;YAGE O;PANASONIC; YAGEO	100K	RES; SMT (0603); 100K; 1%; ±100PPM/DEGC; 0.1000W
42	R29-R35	-	7	CRCW060320R0FK; ERJ-3EKF20R0	VISHAY DALE; PANASONIC	20	RES; SMT (0603); 20; 1%; ±100PPM/DEGC; 0.1000W
43	R37, R40, R42	-	3	CRCW06034K70FK	VISHAY DALE	4.7K	RES; SMT (0603); 4.7K; 1%; ±100PPM/DEGC; 0.1000W
44	R43	-	1	ERJ-3EKF1603	PANASONIC	160K	RES; SMT (0603); 160K; 1%; ±100PPM/DEGC; 0.1000W
45	R45	-	1	CRCW060318K0FK	VISHAY DALE	18K	RES; SMT (0603); 18K; 1%; ±100PPM/DEGC; 0.1000W
46	R46-R48	-	3	CRCW06031K00FK; ERJ-3EKF1001; CR0603AFX-1001ELF; RMCF0603FT1K00	VISHAY; PANASONIC; BOURNS; STACKPOLE ELECTRONICS INC.	1K	RES; SMT (0603); 1K; 1%; ±100PPM/DEGC; 0.1000W
47	SU1-SU7	-	7	S1100-B;SX1100-B; STC02SYAN	KYCON; KYCON; SULLINS ELECTRONICS CORP.	SX1100-B	TEST POINT; JUMPER; STR; TOTAL LENGTH=0.24IN; BLACK; INSULATION=PBT;PHOSPHOR BRONZE CONTACT=GOLD PLATED
48	SW1	-	1	219-7MST	CTS	219-7MST	SWITCH; SPST; SMT; STRAIGHT; 20V; 0.1A; SURFACE MOUNT DIP SWITCH-AUTO PLACEABLE; RINSULATION=1000M OHM
49	T1, T2	-	2	250-408	WAGO	250-408	CONNECTOR; FEMALE; THROUGH HOLE; COMPACT TERMINAL STRIP WITH PUSH BUTTON; STRAIGHT; 8PINS

50	U1	-	1	MAX22196ATJ+	MAXIM	MAX22196ATJ+	EVKIT PART - IC; INDUSTRIAL OCTAL SINK/SOURCE DIGITAL INPUT; PACKAGE OUTLINE DRAWING: 21-0140; LAND PATTERN: 90-0013; PACKAGE CODE: T3255+8C
51	U2	-	1	MAX1556ETB+	MAXIM	MAX1556ETB+	IC; CONV; PWM STEP-DOWN DC-DC CONVERTER; TDFN10-EP 3X3
52	U3	-	1	93LC66BT-E/OT	MICROCHIP	93LC66BT-E/OT	IC; EPROM; 4K MICROWIRE SERIAL EEPROM; SOT23-6
53	U4	-	1	FT2232HQ	FUTURE TECHNOLOGY DEVICES INTL LTD.	FT2232HQ	IC; MMRY; DUAL HIGH SPEED USB TO MULTIPURPOSE UART/FIFO; QFN64-EP
54	U5	-	1	MAX14483AAP+	MAXIM	MAX14483AAP+	IC; DISO; 6-CHANNEL; LOW-POWER; 3.75KVRMS SPI DIGITAL ISOLATOR; SSOP20
55	X1	-	1	ZX62RD-AB-5P8(30)	HIROSE ELECTRIC CO LTD.	ZX62RD-AB-5P8(30)	CONNECTOR; MALE; THROUGH HOLE; MICRO-USB CONNECTOR MEETING REQUIREMENTS OF USB 2.0 STANDARD; RIGHT ANGLE; 5PINS
56	Y1	-	1	ABM7-12.000MHZ-D2Y-T	ABRACON	12MHZ	CRYSTAL; SMT; 12MHZ; 18PF; TOL = ±20PPM; STABILITY = ±30PPM
57	PCB	-	1	MAX22196	MAXIM	PCB	PCB:MAX22196
58	C12	DNP	0	GRM32EC72A106KE05	MURATA	10µF	CAP; SMT (1210); 10µF; 10%; 100V; X7S; CERAMIC
59	R38	DNP	0	CRCW25120000Z0EGHP	VISHAY DRALORIC	0	RES; SMT (2512); 0; JUMPER; JUMPER; 1.5000W
60	R10, R20, R27	DNP	0	N/A	N/A	OPEN	PACKAGE OUTLINE 0603 RESISTOR
TOTAL			176				

MAX22196 EV Kit Schematic

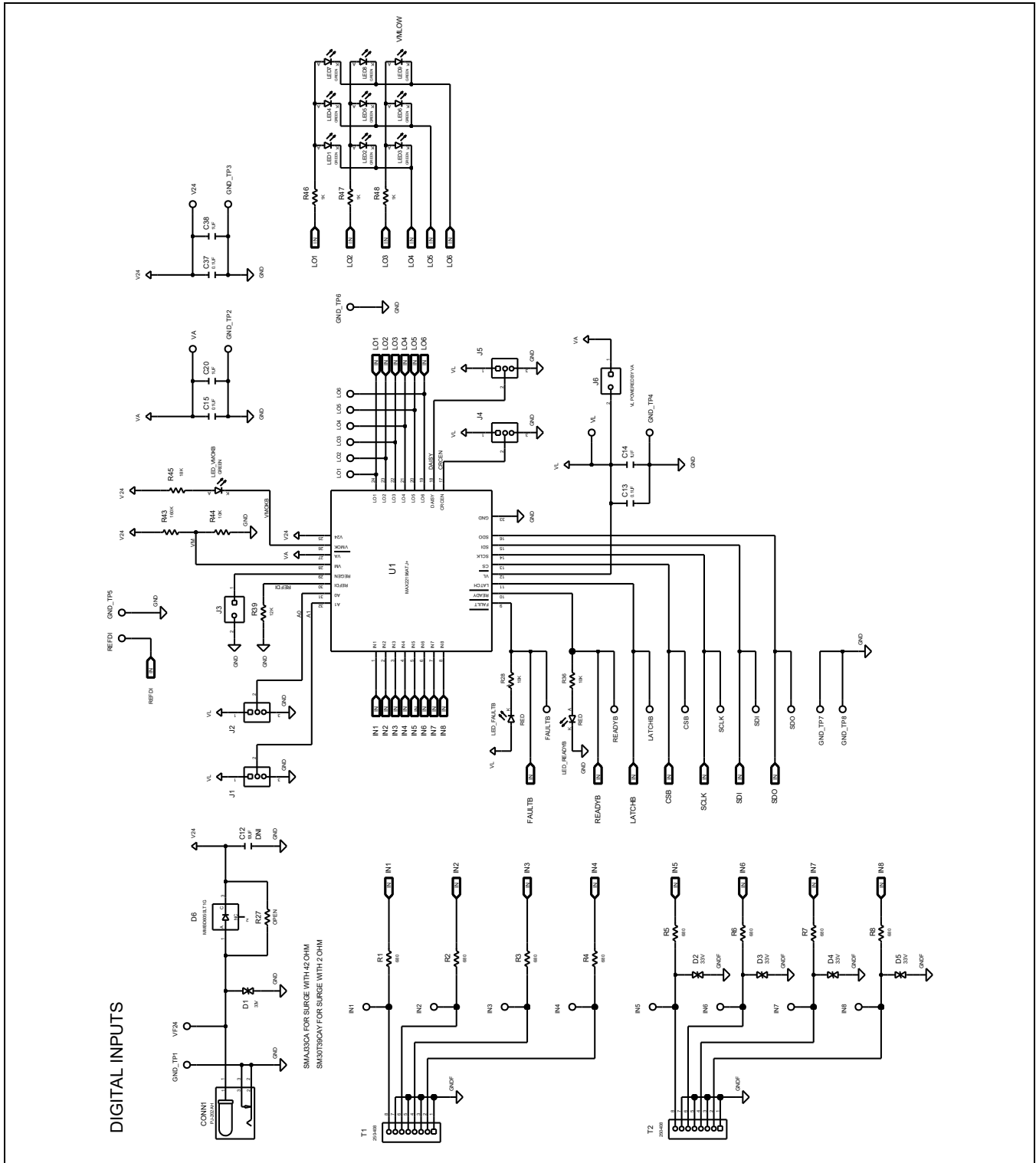

MAX22196 EV Kit Schematic (continued)

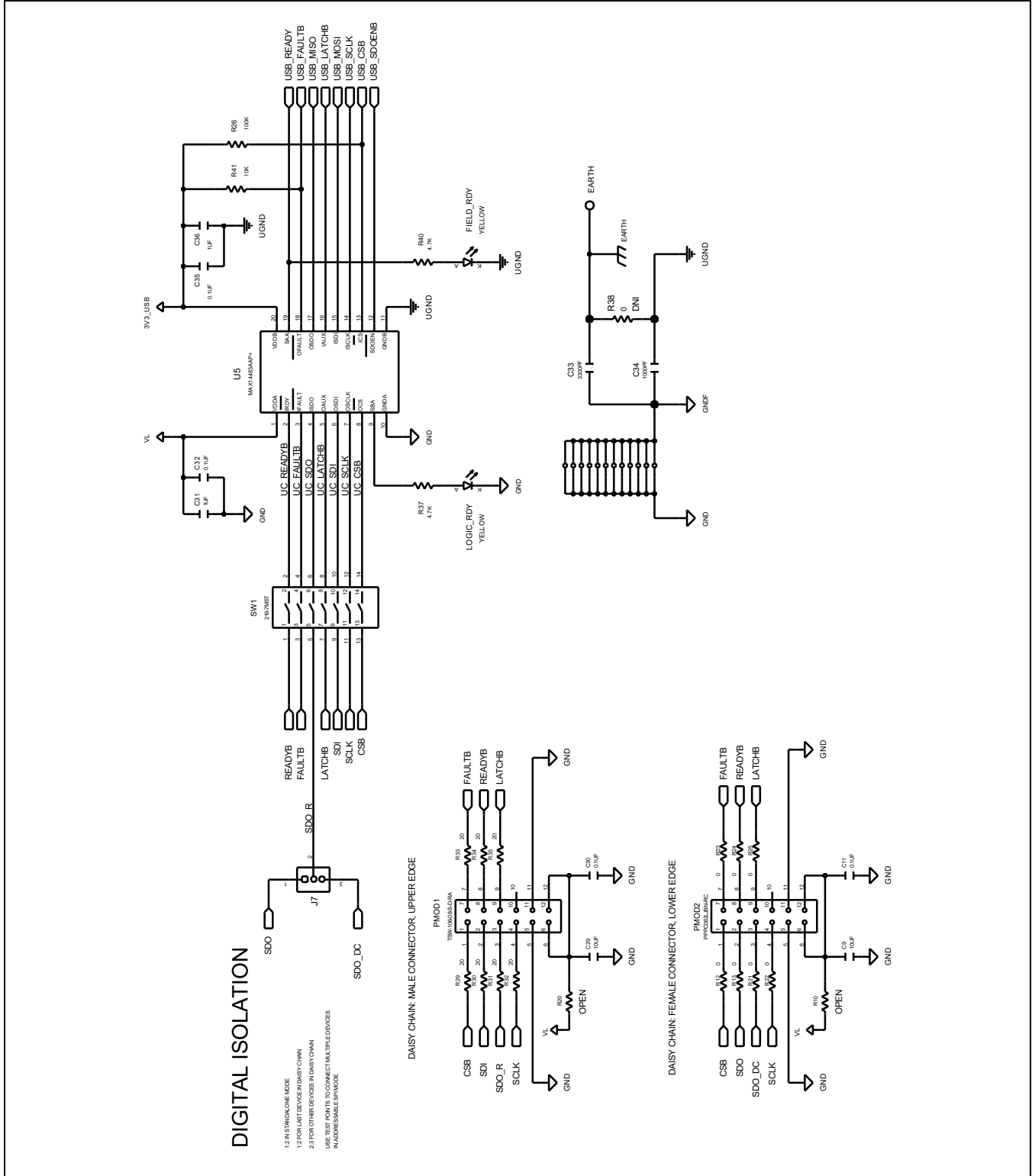

MAX22196 EV Kit Schematic (continued)

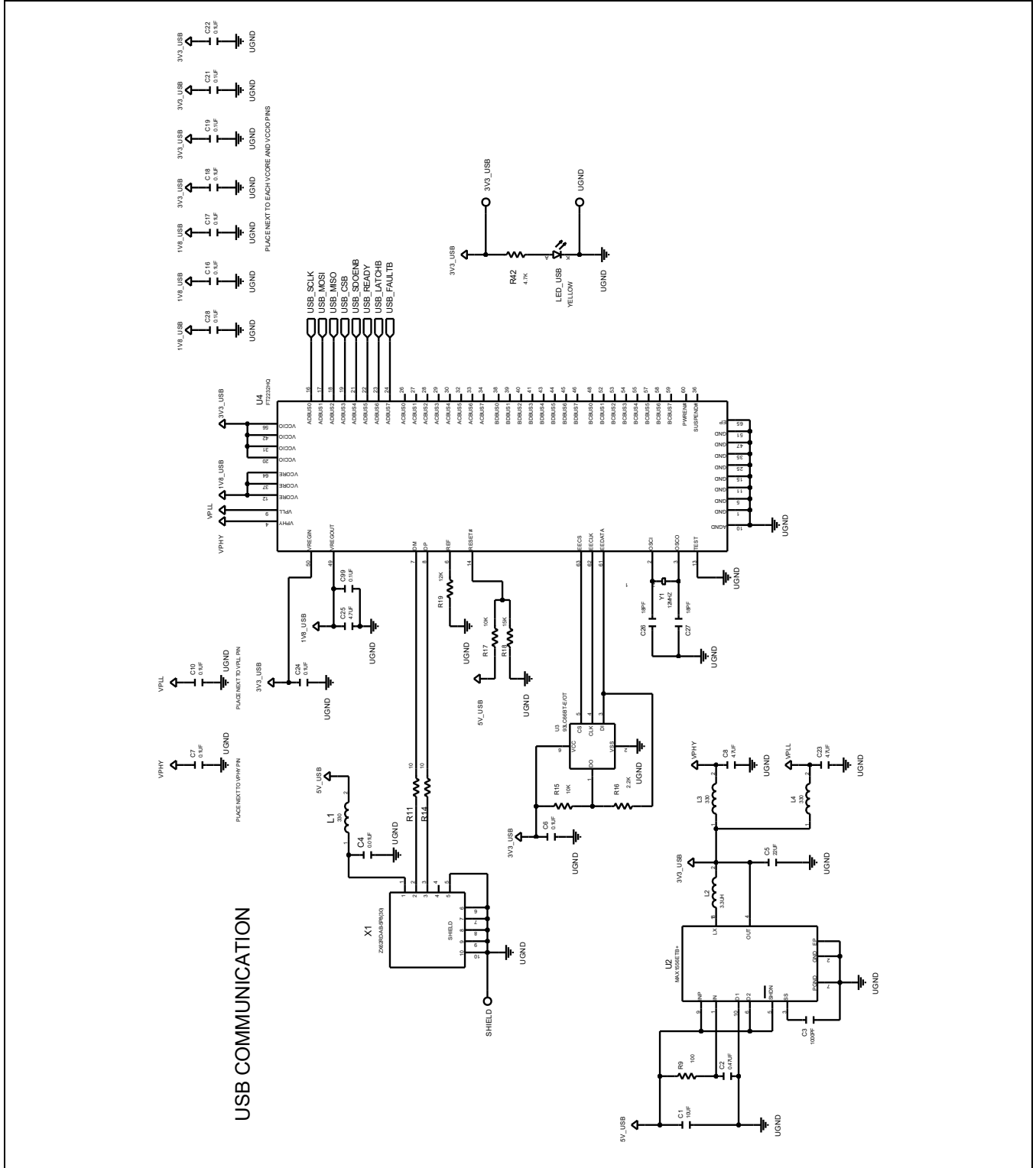

MAX22196 Evaluation Kit

Evaluates: MAX22194, MAX22196

MAX22196 EV Kit PCB Layout

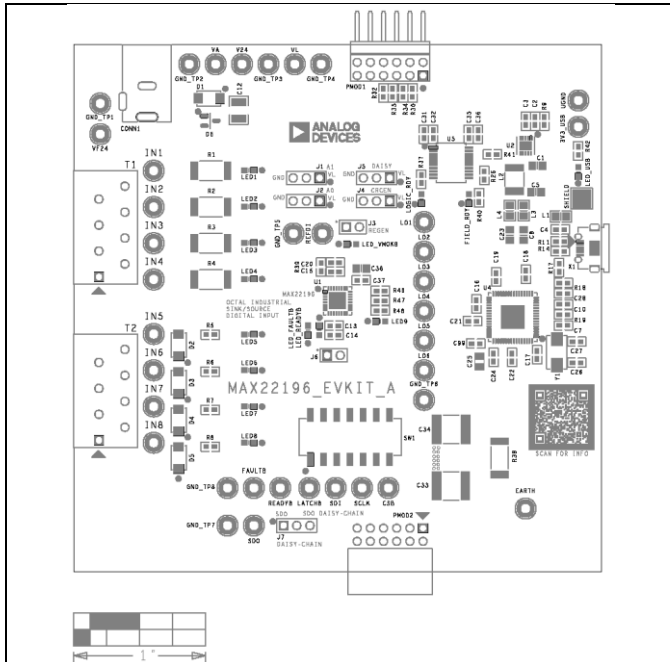

MAX22196 EV Kit Component Placement Guide—Top Silkscreen

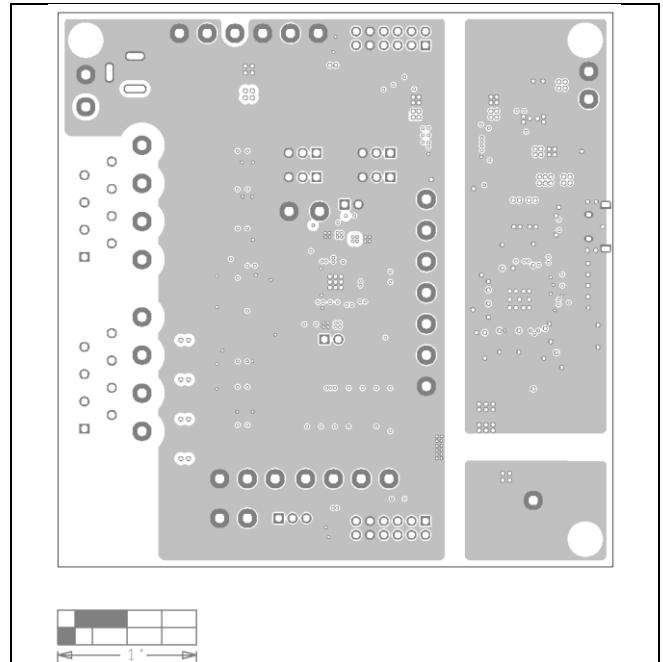

MAX22196 EV Kit PCB Layout—Layer 2

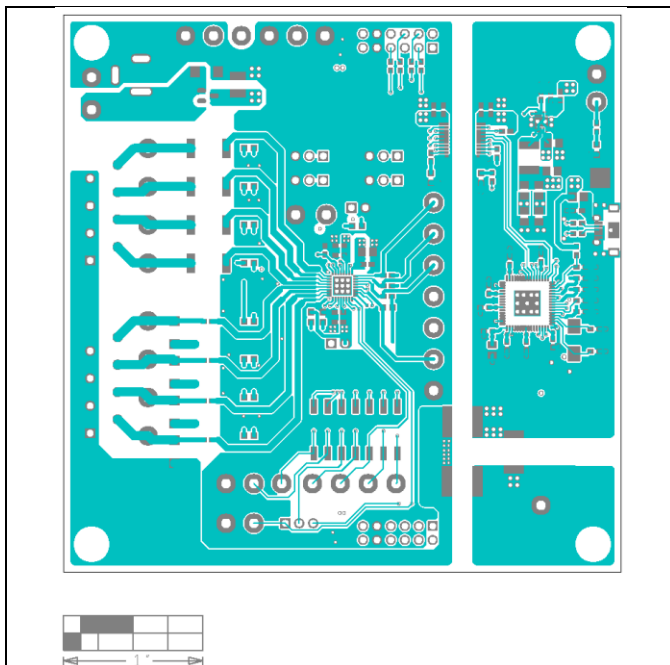

MAX22196 EV Kit PCB Layout—Top

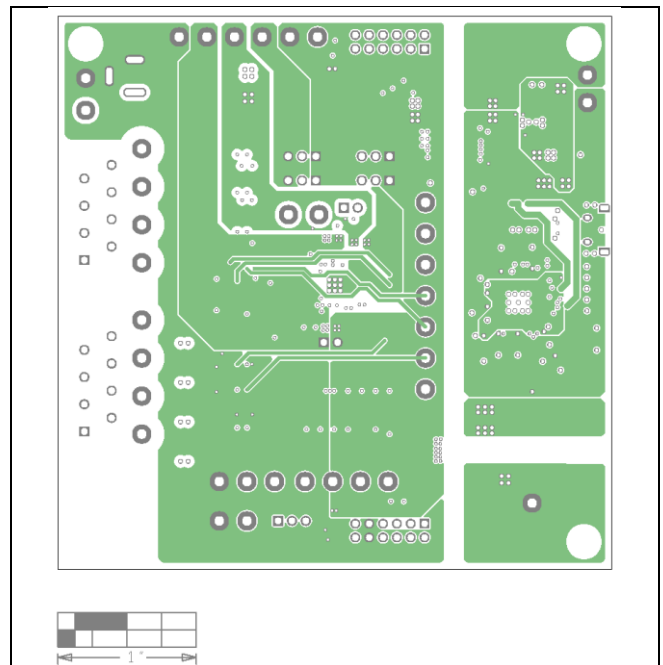

MAX22196 EV Kit PCB Layout—Layer 3

MAX22196 EV Kit PCB Layout (continued)

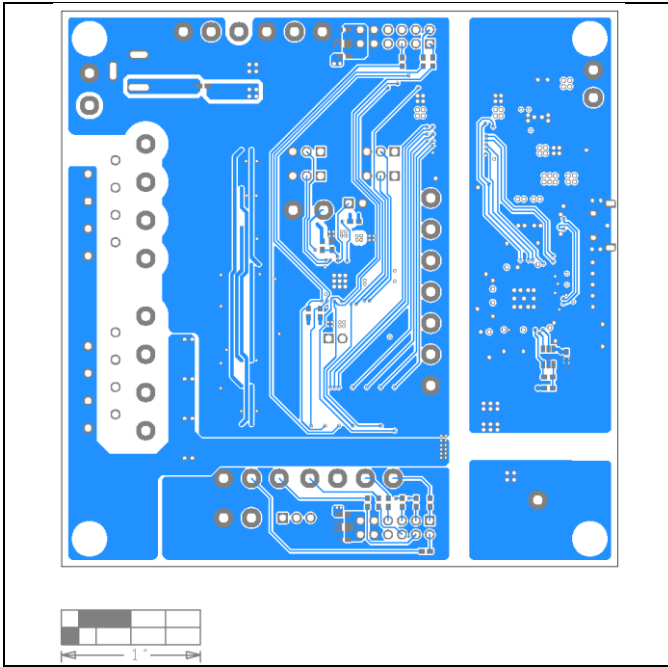

MAX22196 EV Kit PCB Layout—Bottom

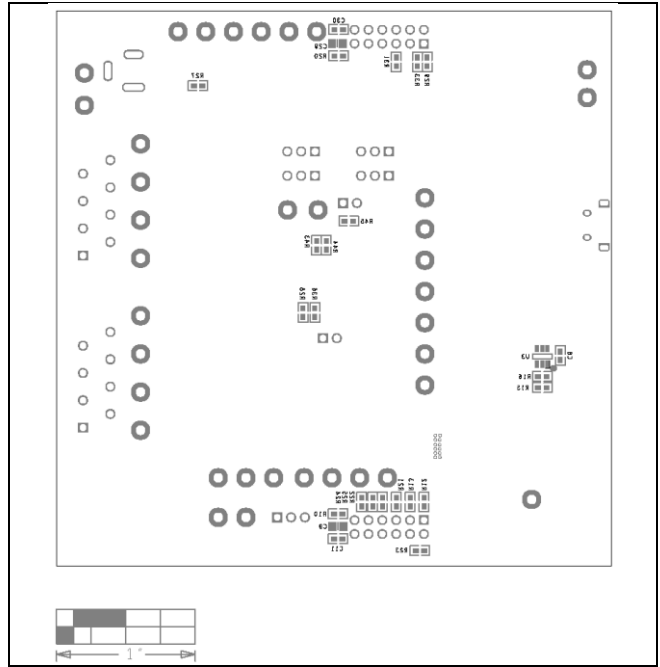

MAX22196 EV Kit Component Placement Guide—Bottom Silkscreen

Revision History

REVISION NUMBER	REVISION DATE	DESCRIPTION	PAGES CHANGED
0	02/23	Initial release	—
1	04/24	Updated EV Kit Title, General Description, Features and Benefits, EV Kit Contents, MAX22196 EV Kit Files, Quick Start, EV Kit System Block Diagram, Table 2, Detailed Description of Hardware, Digital Inputs and Surge Protection, LED Matrix, and Ordering Information	1, 2, 5, 6, 7–9, 14

