

MAX17575EVKITBE# Evaluation Kit

Evaluates: MAX17575 in 5V Output-Voltage Application

General Description

The MAX17575EVKITBE# (EV kit) provides a proven design to evaluate the MAX17575 high-voltage, high-efficiency, synchronous step-down DC-DC converter. The EV kit is preset for 5V output at load currents up to 1.5A and features a 500kHz switching frequency for optimum efficiency and component size. The EV kit features adjustable input undervoltage-lockout, adjustable soft-start, open-drain $\overline{\text{RESET}}$ signal, and external clock synchronization. The EV kit also provides a good layout example, which is optimized for conducted, radiated EMI, and thermal performance. For more details about the IC benefits and features, refer to the MAX17575 data sheet.

Features

- Operates From a 6.5V to 60V Input Supply
- Programmed 5V Output Voltage, 1.5A Load Current
- 500kHz Switching Frequency
- Enable/UVLO Input, Resistor-Programmable UVLO Threshold
- Adjustable Soft-Start Time
- Open-Drain $\overline{\text{RESET}}$ Output
- External Clock Synchronization
- Overcurrent and Overtemperature Protection
- Proven PCB Layout
- Fully Assembled and Tested
- Complies with CISPR22(EN55022) Class B Conducted and Radiated Emissions

Ordering Information appears at end of data sheet.

Quick Start

Recommended Equipment

- MAX17575EVKITBE#
- 6.5V to 60V, 2A DC input power supply
- Load capable of sinking 1.5A
- Digital voltmeter (DVM)

Equipment Setup and Test Procedure

The EV kit is fully assembled and tested. Follow the steps below to verify the board operation.

Caution: Do not turn on power supply until all connections are completed.

- 1) Set the power supply at a voltage between 6.5V and 60V. Disable the power supply.
- 2) Connect the positive terminal of the power supply to the V_{IN} PCB pad and the negative terminal to the nearest PGND PCB pad. Connect the positive terminal of the 1.5A load to the V_{OUT} PCB pad and the negative terminal to the nearest PGND PCB pad.
- 3) Connect the DVM across the V_{OUT} PCB pad and the nearest PGND PCB pad.
- 4) Verify that shunts are installed across pins 1-2 on jumper JU1 (see [Table 1](#) for details).
- 5) Turn on the DC power supply.
- 6) Enable the load.
- 7) Verify that the DVM displays 5V

Detailed Description of Hardware

The MAX17575EVKITBE# provides a proven design to evaluate the MAX17575 high-voltage, high efficiency, synchronous step-down DC-DC converter. The EV kit is preset for 5V output from 6.5V to 60V input at load currents up to 1.5A and features a 500kHz switching frequency for optimum efficiency and component size. The EV kit includes an EN/UVLO PCB pad and jumper JU1 to enable the output at a desired input voltage. An additional $\overline{\text{RESET}}$ PCB pad is available for monitoring whether the converter output is in regulation.

Soft-Start Capacitor Selection

The EV kit offers an adjustable soft-start operation to reduce inrush current. The soft-start time is adjusted by the value of external soft-start capacitor (C5) connected between SS and SGND. The selected output capacitance (C_{SEL}) and the output voltage (V_{OUT}) determine the minimum required soft-start capacitor as follows:

$$C_{SS} \geq 56 \times 10^{-6} \times C_{SEL} \times V_{OUT}$$

The soft-start time (t_{SS}) is related to the capacitor connected at SS (C_{SS}) by the following equation:

$$t_{SS} = \frac{C_{SS}}{5.55 \times 10^{-6}}$$

For example, to program a 2ms soft-start time, a 12nF capacitor should be connected from the SS pin to GND.

Enable/Undervoltage-Lockout (EN/UVLO) Programming

The MAX17575 offers an Enable and adjustable input undervoltage lockout feature. In this EV kit, for normal operation, leave the EN/UVLO jumper (JU1) open. When JU1 is left open, the MAX17575 is enabled when the

input voltage rises above 6.4V. To disable the MAX17575, install a jumper across pins 2–3 on JU1. See [Table 1](#) for JU1 settings. The EN/UVLO PCB pad on the EV kit supports external Enable/Disable control of the device. Leave JU1 open when external Enable/Disable control is desired. A potential divider formed by R1 and R2 sets the input voltage (V_{INU}) above which the converter is enabled when JU1 is left open.

Choose R1 to be 3.3MΩ (max), and then calculate R2 as follows:

$$R_2 = \frac{R_1 \times 1.215}{(V_{INU} - 1.215)}$$

where, V_{INU} is the voltage at which the device is required to turn on, and R1 and R2 are in kΩ,

For more details about setting the undervoltage lockout level, refer to the MAX17575 data sheet.

Active-Low, Open-Drain Reset Output ($\overline{\text{RESET}}$)

The EV kit provides a $\overline{\text{RESET}}$ PCB pad to monitor the status of the converter. $\overline{\text{RESET}}$ goes high when V_{OUT} rises above 95% (typ) of its nominal regulated output voltage. $\overline{\text{RESET}}$ goes low when V_{OUT} falls below 92% (typ) of its nominal regulated voltage.

Hot Plug-In and Long Input Cables

The MAX17575EVKITBE# PCB layout provides an optional electrolytic capacitor (C_{IN4} = 33μF/80V). This capacitor limits the peak voltage at the input of the MAX17575 when the DC input source is “Hot-Plugged” to the EV kit input terminals with long input cables. The equivalent series resistance (ESR) of the electrolytic capacitor dampens the oscillations caused by interaction of the inductance of the long input cables and the ceramic capacitors at the buck converter IC input.

Table 1. Converter EN/UVLO Jumper (JU1) Settings

SHUNT POSITION	EN/UVLO PIN	MAX17575 OUTPUT
1-2*	Connected to VIN	Enabled
Not installed	Connected to the center node of resistor-divider R1 and R2	Enabled, UVLO level set through the R1 and R2 resistors
2-3	Connected to SGND	Disabled

*Default position.

Electromagnetic Interference (EMI)

Compliance to conducted emissions (CE) standards requires an EMI filter at the input of a switching power converter. The EMI filter attenuates high-frequency currents drawn by the switching power converter and limits the noise injected back into the input power source.

The MAX17575EVKITBE# PCB has designated footprints on the bottom side for placement of EMI filter components. Use of these filter components results in lower conducted emissions below CISPR22 Class B limits. Remove the 0Ω resistor which is placed on the L1 footprint before installing conducted EMI filter components. The MAX17575EVKITBE# PCB layout is also designed to limit radiated emissions from switching nodes of the power converter resulting in radiated emissions below CISPR22 Class B limits

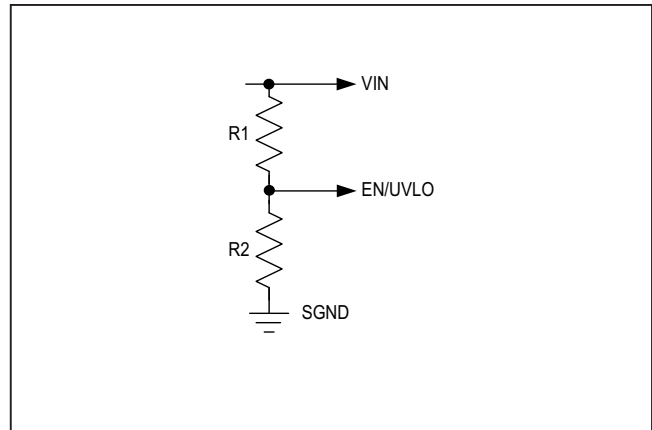

Figure 1. Setting the Input Undervoltage Lockout

Component Suppliers

SUPPLIER	WEBSITE
Coilcraft, Inc.	www.coilcraft.com
Murata Americas	www.murata.com
Panasonic Corp.	www.panasonic.com
Vishay	www.vishay.com
Onsemi	www.onsemi.com
Taiyo Yuden	www.ty-top.com

Note: Indicate that you are using the MAX17575 when contacting these component suppliers.

Ordering Information

PART	TYPE
MAX17575EVKITBE#	EV KIT

#Denotes RoHS compliant.

EV Kit Performance Report

($V_{IN} = 24V$, $V_{OUT} = 5V$, $I_{OUT} = 1.5A$, $f_{SW} = 500kHz$, $T_A = +25^{\circ}C$, unless otherwise noted.)

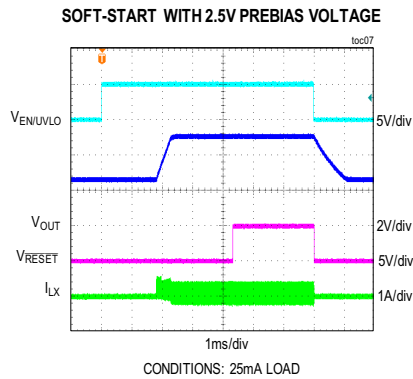
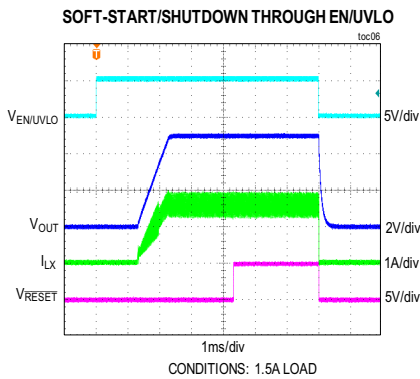
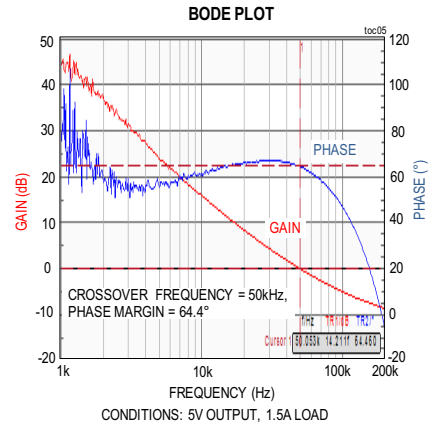
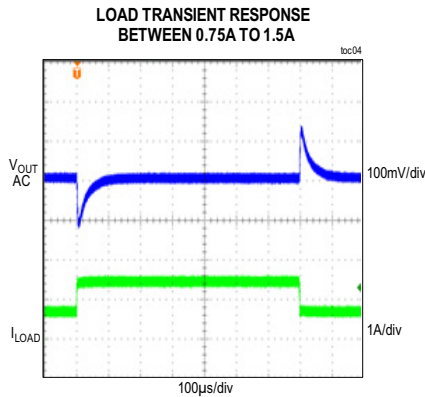
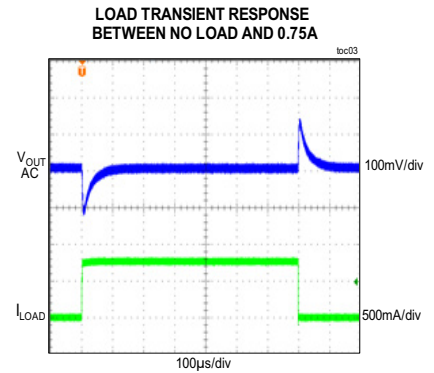
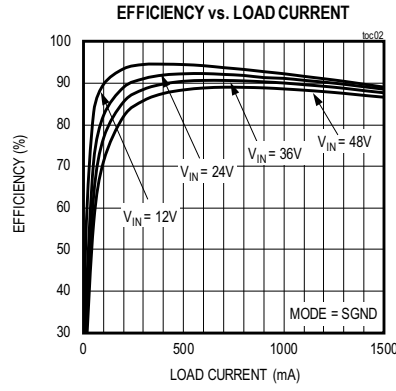
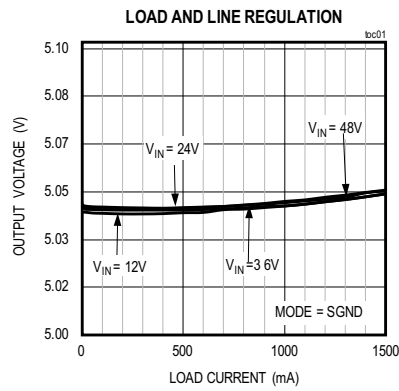

EV Kit Performance Report (continued)

($V_{IN} = 24V$, $V_{OUT} = 5V$, $I_{OUT} = 1.5A$, $f_{SW} = 500kHz$, $T_A = +25^{\circ}C$, unless otherwise noted.)

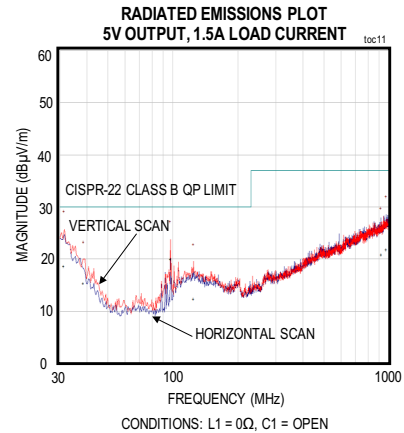
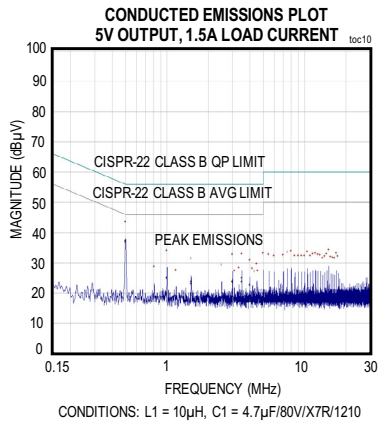
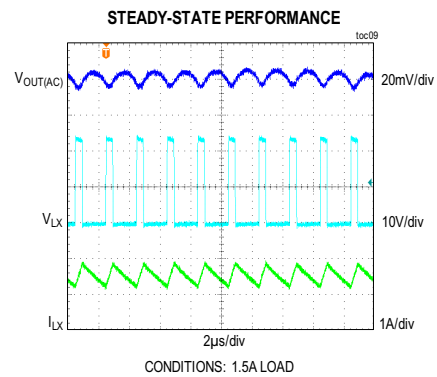
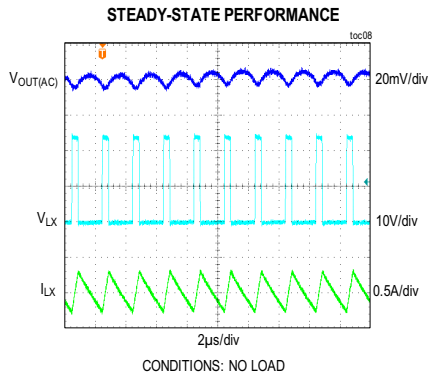

MAX17575EVKITBE# Evaluation Kit

Evaluates: MAX17575 in 5V Output-Voltage Application

MAX17575EVKITBE# Bill of Materials

S.No	DESIGNATOR	DESCRIPTION	QUANTITY	MANUFACTURER PART NUMBER
1	C2	100pF, 10%, 25V, COG, Ceramic capacitor (0402)	1	KEMET C0402C101K5GAC; TDK C1005C0G1H101K050BA
2	C3	47pF, 5%, 50V, COG, Ceramic capacitor (0402)	1	TAIYO YUDEN UMK105CG470JVHF
3	C4, C7, CO6, CO7	0.1µF, 10%, 16V, X7R, 0402, Ceramic capacitor (0402)	4	TAIYO YUDEN EMK105B7104KV-F
4	C8	2.2µF, 10%, 10V, X7R, Ceramic capacitor (0402)	1	MURATA GRM188R71A225KE15
5	C10	5600pF, 5%, 50V, COG, Ceramic capacitor (0402)	1	MURTA GRM1555C1H562GE01
6	CIN1,CIN7	0.1µF, 10%, 100V, X7R, Ceramic capacitor (0603)	2	TAIYO YUDEN HMK107B7104KA-T
7	CIN2	2.2µF, 10%, 100V, X7R, Ceramic capacitor (1210)	1	TAIYO YUDEN HMK325B7225KM-P
8	CIN4	ALUMINUM-ELECTROLYTIC; 33UF; 80V; TOL=20%; MODEL=FK SERIES	1	PANASONIC EEE-FK1K330P
9	CIN5	0.47µF, 10%, 100V, X7R, Ceramic capacitor (0805)	1	AVX 08051C474KAT2A
10	CIN6	220pF, 5%, 100V, COG, Ceramic capacitor (0603)	1	TDK C1608C0G2A221J080AA
11	CO1	22µF, 10%, 25V, X7R, Ceramic capacitor (1210)	1	MURATA GRM32ER71E226ME15
12	CO9	2.2µF, 10%, 25V, X7R, Ceramic capacitor (0603)	1	MURATA GRM188R71A225KE15
13	D1	Diode PIV=30V; IF=0.2A	1	VISHAY BAT54WS-E3-08
14	L3	INDUCTOR, 15µH, 6A (6mm x 6mm)	1	COILCRAFT XAL6060-153ME
15	R1	RES+, 3.32MΩ, 1% (0402)	1	VISHAY DALE CRCW04023M32FK
16	R2	RES+, 787KΩ, 1% (0402)	1	VISHAY DALE CRCW0402787KFK
17	R3	RES+, 40.2KΩ, 1% (0402)	1	VISHAY DALE CRCW040240K2FK
18	R4	RES+, 75KΩ, 1% (0402)	1	VISHAY DALE CRCW040275K0FK
19	R5	RES+, 10KΩ, 1% (0402)	1	VISHAY DALE CRCW040210K0FK
20	R6	RES+, 16.5KΩ, 1% (0402)	1	VISHAY DALE CRCW040216K5FK
21	R7	RES+, 1KΩ, 1% (0402)	1	IMS RCC-0805-1001J
22	R8	RES+, 4.7Ω, 1% (0402)	1	VISHAY DALE CRCW04024R70FK
23	R9	RES+, 0Ω, 1% (1812)	1	VISHAY DALE RCA12180000Z0EKLS
24	U1	HIGH-EFFICIENCY; SYNCHRONOUS STEP-DOWN DC-DC CONVERTER; (TDFN12-EP 3mm x 3mm)	1	MAX17575ATC+
25	JU1	3-pin header (36-pin header 0.1" centers)	1	Sullins: PEC03SAAN
26	-	Shunts	1	SULLINS STC02SYAN
27	MH1-MH4	MACHINE SCREW; SLOTTED	4	EAGLE PLASTIC DEVICES P440.375
28	MH1-MH4	HEX STANDOFF #4-40 NYLON 3/8"	4	KEYSTONE ELECTRONICS 1902B
29	C1	OPTIONAL: 4.7µF, 10%, 80V, X7R, Ceramic capacitor (1210)	1	MURATA GRM32ER71K475KE14
30	L1	OPTIONAL: INDUCTOR, 10µH, 3.1A (4mm x 4mm)	1	COILCRAFT XAL4040-103ME
31	CIN3, CO2	OPEN: Capacitor (1210)	0	
32	CO3, CO4, CO5	OPEN: Capacitor (0805)	0	
33	CO8	OPEN: Capacitor (0603)	0	

DEFAULT JUMPER TABLE	
JUMPER	SHUNT POSITION
JU1	1 - 2

MAX17575EVKITBE# PCB Layout

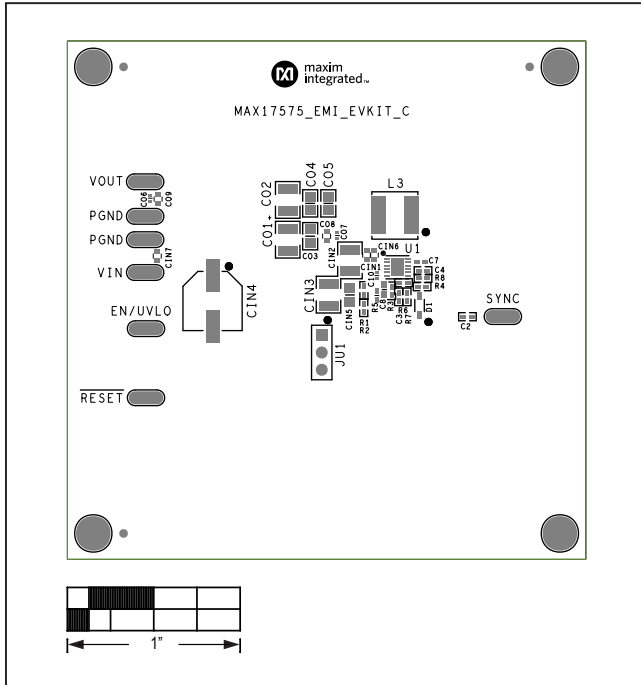

MAX17575EVKITBE# PCB Layout—Top Silkscreen

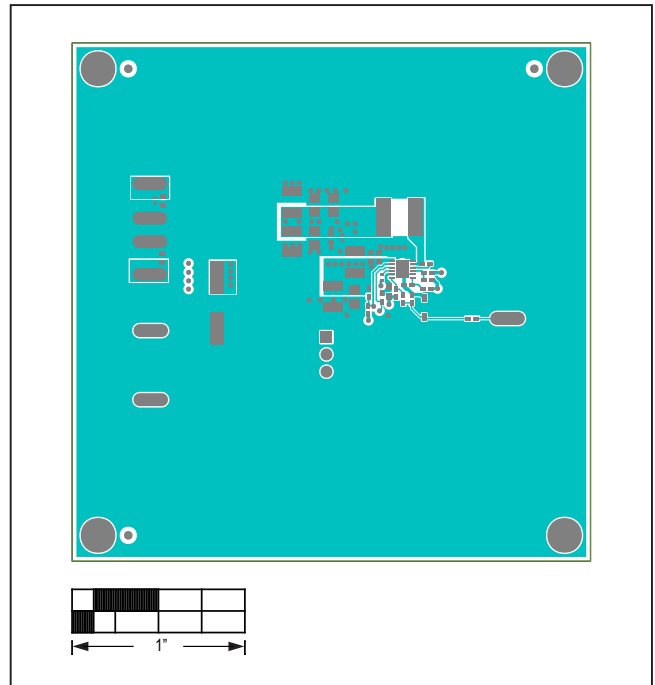

MAX17575EVKITBE# PCB Layout—Top Layer

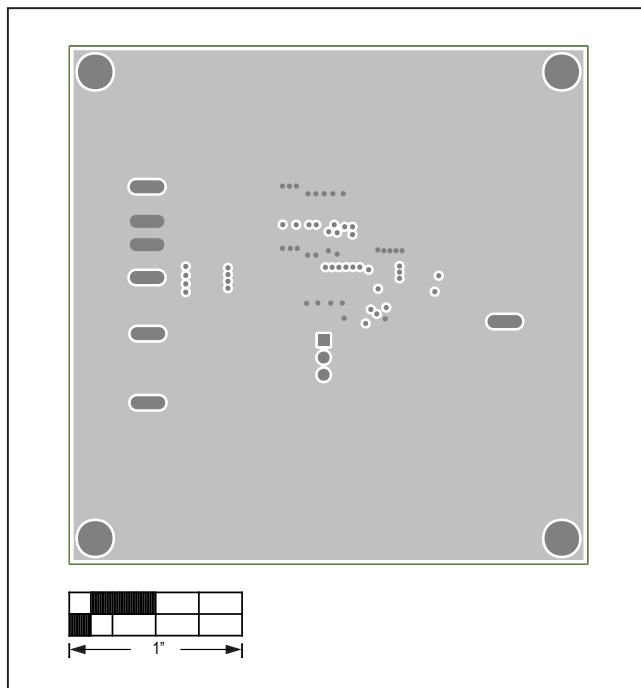

MAX17575EVKITBE# PCB Layout—Layer 2

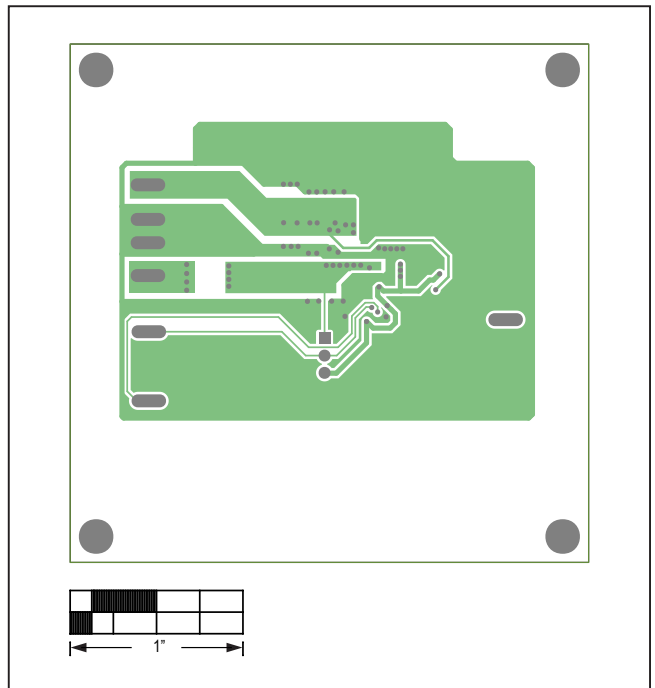

MAX17575EVKITBE# PCB Layout—Layer 3

MAX17575EVKITBE# PCB Layout (continued)

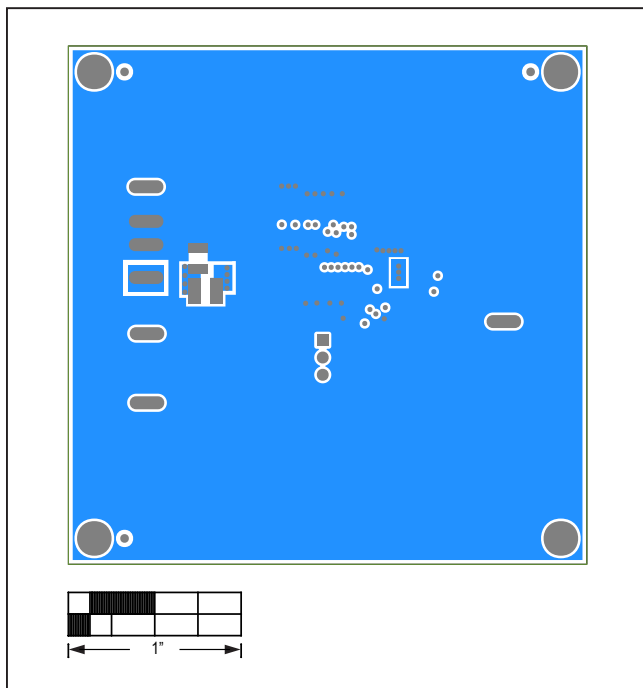

MAX17575EVKITBE# PCB Layout—Bottom Layer

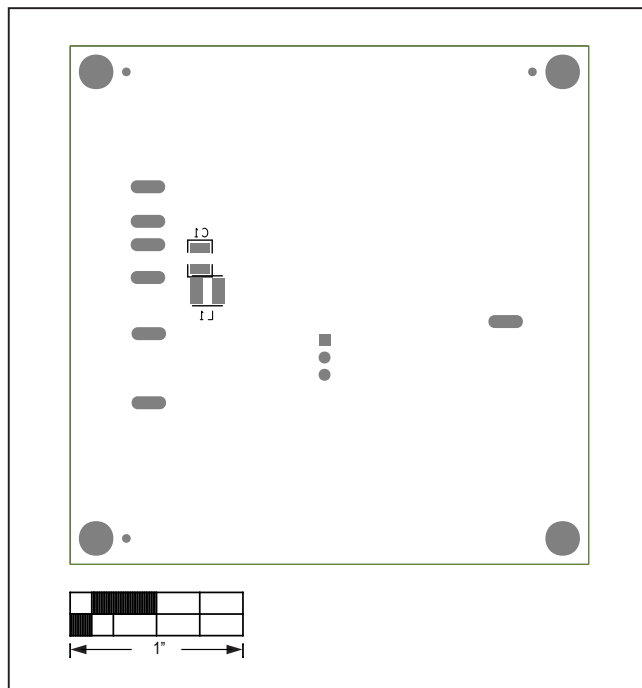

MAX17575EVKITBE# PCB Layout—Bottom Silkscreen

Revision History

REVISION NUMBER	REVISION DATE	DESCRIPTION	PAGES CHANGED
0	4/19	Initial release	—

For pricing, delivery, and ordering information, please visit Maxim Integrated's online storefront at <https://www.maximintegrated.com/en/storefront/storefront.html>.

Maxim Integrated cannot assume responsibility for use of any circuitry other than circuitry entirely embodied in a Maxim Integrated product. No circuit patent licenses are implied. Maxim Integrated reserves the right to change the circuitry and specifications without notice at any time.