

Low Noise Amplifier with Bypass Switch 0.1 GHz to 10 GHz

FEATURES

- ▶ Integrated amplifier bypass switch
- ▶ Self biased with adjustable bias current
- ▶ Gain in amplifier path: 16 dB typical at 7 GHz to 10 GHz
- ▶ OIP3 in amplifier path: 36.5 dBm typical at 0.1 GHz to 4 GHz
- ▶ Noise figure in amplifier path: 2 dB typical at 0.1 GHz to 4 GHz
- ▶ Insertion loss in bypass path: 1.5 dB typical at 0.1 GHz to 4 GHz
- ▶ 16-lead, 3 mm × 3 mm LFCSP package

APPLICATIONS

- ▶ Test and measurement equipment
- ▶ Wideband high dynamic range receivers

GENERAL DESCRIPTION

The HMC8414 is a low noise wideband amplifier with a bypass switch that operates from 0.1 GHz to 10 GHz. The integrated bypass switch enables high dynamic range systems with large receive path signal variation. In the bypass path, typical insertion loss and input third-order intercept (IIP3) are 1.5 dB and 49.4 dBm, respectively.

The HMC8414 features inputs and outputs that are internally matched to 50 Ω over the full operating range of the device. The single positive supply voltage can range from 3 V to 6 V. The bias current is set by a resistor connected between the RBIAS pin and VDD pins (RFOUT/VDD1 and VDD2), and can be varied around its nominal value of 90 mA.

The HMC8414 is fabricated on a gallium arsenide (GaAs), pseudo-morphic high electron mobility transistor (pHEMT) process. It is housed in an RoHS-compliant, 3 mm × 3 mm, LFCSP package and is specified for operation from -40°C to +85°C.

FUNCTIONAL BLOCK DIAGRAM

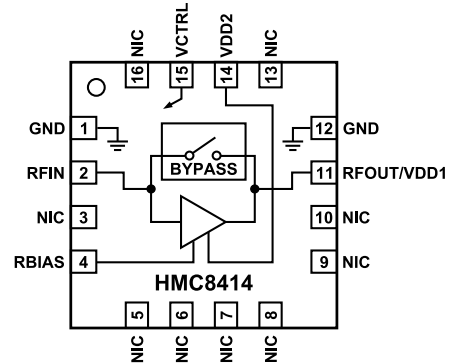

Figure 1.

001

TABLE OF CONTENTS

Features.....	1	Interface Schematics.....	7
Applications.....	1	Typical Performance Characteristics.....	8
General Description.....	1	Internal Amplifier State.....	8
Functional Block Diagram.....	1	Internal Bypass Switch State.....	26
Specifications.....	3	Theory of Operation.....	29
0.1 GHz to 4 GHz Frequency Range.....	3	Applications Information.....	30
4 GHz to 7 GHz Frequency Range.....	3	Amplifier Bypass Mode Response	31
7 GHz to 10 GHz Frequency Range.....	4	Recommended Power Management Circuit.....	32
DC Specifications.....	5	Using the RBIAS Pin to Enable and Disable the HMC8414.....	33
Absolute Maximum Ratings.....	6	Outline Dimensions.....	34
Thermal Resistance.....	6	Ordering Guide.....	34
Electrostatic Discharge (ESD) Ratings.....	6	Evaluation Boards.....	34
ESD Caution.....	6		
Pin Configuration and Function Descriptions.....	7		

REVISION HISTORY**7/2024—Rev. 0 to Rev. A**

Change to Table 6.....	6
------------------------	---

10/2023—Revision 0: Initial Version

SPECIFICATIONS

0.1 GHZ TO 4 GHZ FREQUENCY RANGE

Drain bias voltage (V_{DD}) = 5 V, supply current (I_{DQ}) = 90 mA, R_{BIAS} = 499 Ω , and T_A = 25°C, V_{CTRL} = 5 V, unless otherwise noted.

Table 1. 0.1 GHz to 4 GHz Frequency Range Specifications

Parameter	Min	Typ	Max	Unit	Test Conditions/Comments
FREQUENCY RANGE	0.1		4	GHz	
INTERNAL AMPLIFIER STATE					
Gain	14.5	16.5		dB	
Gain Variation over Temperature		0.005		dB/°C	
NOISE FIGURE		2		dB	
RETURN LOSS					
Input (S11)		13		dB	
Output (S22)		18		dB	
OUTPUT					
Output Power for 1 dB Compression (OP1dB)	18.5	20.5		dBm	
Saturated Output Power (P_{SAT})		22		dBm	
Output Third-Order Intercept (OIP3)		36.5		dBm	Measurement taken at output power (P_{OUT}) per tone = 5 dBm
Output Second-Order Intercept (OIP2)		44		dBm	Measurement taken at P_{OUT} per tone = 5 dBm
INTERNAL BYPASS SWITCH STATE					
Insertion Loss		1.5		dB	V_{CTRL} = 0 V
Input Third-Order Intercept (IIP3)		49.4		dBm	V_{CTRL} = 0 V; measurement taken at P_{OUT} per tone = 5 dBm
Input Second-Order Intercept (IIP2)		79.9		dBm	V_{CTRL} = 0 V; measurement taken at P_{OUT} per tone = 5 dBm
Input Power for 1 dB Compression (IP1dB)		27.7		dBm	V_{CTRL} = 0 V

4 GHZ TO 7 GHZ FREQUENCY RANGE

V_{DD} = 5 V, I_{DQ} = 90 mA, R_{BIAS} = 499 Ω , and T_A = 25°C, unless otherwise noted.

Table 2. 4 GHz to 7 GHz Frequency Range Specifications

Parameter	Min	Typ	Max	Unit	Test Conditions/Comments
FREQUENCY RANGE	4		7	GHz	
INTERNAL AMPLIFIER STATE					
Gain	14	16		dB	
Gain Variation over Temperature		0.01		dB/°C	
NOISE FIGURE		2.3		dB	
RETURN LOSS					
S11		11		dB	
S22		13		dB	
OUTPUT					
OP1dB	18	20		dBm	
P_{SAT}		22		dBm	
OIP3		33.5		dBm	Measurement taken at P_{OUT} per tone = 5 dBm
OIP2		35.5		dBm	Measurement taken at P_{OUT} per tone = 5 dBm
INTERNAL BYPASS STATE					
Insertion Loss		2		dB	V_{CTRL} = 0 V

SPECIFICATIONS

Table 2. 4 GHz to 7 GHz Frequency Range Specifications (Continued)

Parameter	Min	Typ	Max	Unit	Test Conditions/Comments
IIP3		43.7		dBm	$V_{CTRL} = 0\text{ V}$; measurement taken at P_{OUT} per tone = 5 dBm
IIP2		86.4		dBm	$V_{CTRL} = 0\text{ V}$; measurement taken at P_{OUT} per tone = 5 dBm
IP1dB		27.2		dBm	$V_{CTRL} = 0\text{ V}$

7 GHZ TO 10 GHZ FREQUENCY RANGE

$V_{DD} = 5\text{ V}$, $I_{DQ} = 90\text{ mA}$, $R_{BIAS} = 499\ \Omega$, and $T_A = 25^\circ\text{C}$, unless otherwise noted.

Table 3. 7 GHz to 10 GHz Frequency Range Specifications

Parameter	Min	Typ	Max	Unit	Test Conditions/Comments
FREQUENCY RANGE	7		10	GHz	
INTERNAL AMPLIFIER STATE					
Gain	14	16.5		dB	
Gain Variation over Temperature		0.006		dB/ $^\circ\text{C}$	
NOISE FIGURE		3		dB	
RETURN LOSS					
S11		14		dB	
S22		18		dB	
OUTPUT					
OP1dB		17.5		dBm	
P_{SAT}		19		dBm	
OIP3		33.5		dBm	Measurement taken at P_{OUT} per tone = 5 dBm
OIP2		38		dBm	Measurement taken at P_{OUT} per tone = 5 dBm
INTERNAL BYPASS STATE					
Insertion Loss		2.5		dB	$V_{CTRL} = 0\text{ V}$
IIP3		43		dBm	$V_{CTRL} = 0\text{ V}$; measurement taken at P_{OUT} per tone = 5 dBm
IIP2		85.2		dBm	$V_{CTRL} = 0\text{ V}$; measurement taken at P_{OUT} per tone = 5 dBm
IP1dB		25.3		dBm	$V_{CTRL} = 0\text{ V}$

SPECIFICATIONS

DC SPECIFICATIONS

Table 4. DC Specifications

Parameter	Min	Typ	Max	Unit
SUPPLY CURRENT				
Internal Amplifier State				
I_{DQ}	70	90	110	mA
Amplifier Current (I_{DQ_AMP})		86.5		mA
R _{BIAS} Current (I_{RBIAS})		3.5		mA
Control Switch Current (I_{CTRL})		0.4		mA
Internal Bypass Switch State				
I_{DQ}				
I_{DQ_AMP}		3		mA
I_{RBIAS}		0		mA
I_{CTRL}		0		mA
SUPPLY VOLTAGE				
Internal Amplifier State				
V_{DD}	3	5	6	V
V_{BIAS}	3	5	6	V
V_{CTRL}	3	5	6	V
Internal Bypass Switch State				
V_{DD}		5		V
V_{BIAS}		5		V
V_{CTRL}		0		V

Table 5. Logic Control (V_{CTRL})

Parameter	Min	Typ	Max	Unit	Test Conditions/Comments
DIGITAL CONTROL INPUT					
Low (Bypass Mode)	0		1.9	V	< 10 μ A typical current
High (Amplifier Mode)	2.2		V_{DD}	V	< 400 μ A typical current
SWITCHING TIME					
Amplifier Mode On Time		110		ns	50% V_{CTRL} to 90% of RF output
Amplifier Mode Off Time		300		ns	50% V_{CTRL} to 90% of RF output
RF SETTLING TIME					
0.1 dB		150		ns	50% rising V_{CTRL} to 0.1 dB of final RF output
0.05 dB		157		ns	50% rising V_{CTRL} to 0.05 dB of final RF output
0.1 dB		450		ns	50% falling V_{CTRL} to 0.1 dB of final RF output
0.05 dB		460		ns	50% falling V_{CTRL} to 0.05 dB of final RF output

ABSOLUTE MAXIMUM RATINGS

Table 6.

Parameter	Rating
V _{DD}	7 V
V _{CTRL}	7 V
Continuous RF Input Power (RF _{IN}) LNA Mode	23 dBm
Continuous RF _{IN} Bypass Switch Mode	32 dBm
Continuous Power Dissipation (P _{DISS}), T = 85°C (Derate 1.48 mW/°C Above 85°C)	1.25 W
Temperature	
Storage Range	-65°C to +150°C
Operating Range	-40°C to +85°C
Nominal Temperature (T _{CASE} = 85°C, V _{DD} = 5 V, I _{DQ} = 90 mA, Input Power (P _{IN}) = Off)	121°C
Maximum Junction	175°C

Stresses at or above those listed under Absolute Maximum Ratings may cause permanent damage to the product. This is a stress rating only; functional operation of the product at these or any other conditions above those indicated in the operational section of this specification is not implied. Operation beyond the maximum operating conditions for extended periods may affect product reliability.

THERMAL RESISTANCE

Thermal performance is directly linked to printed circuit board (PCB) design and operating environment. Careful attention to PCB thermal design is required.

θ_{JC} is the channel to case thermal resistance.

Table 7. Thermal Resistance

Package	θ_{JC}	Unit
CP-16-35		
Quiescent, T _{CASE} = 25°C	60	°C/W
Worst Case, T _{CASE} = 85°C	72	°C/W

ELECTROSTATIC DISCHARGE (ESD) RATINGS

The following ESD information is provided for handling of ESD-sensitive devices in an ESD protected area only.

Human body model (HBM) per ANSI/ESDA/JEDEC JS-001.

Table 8. ESD Ratings for HMC8414

ESD Model	Withstand Threshold (V)	Class
HBM	±750	1B

ESD CAUTION



ESD (electrostatic discharge) sensitive device. Charged devices and circuit boards can discharge without detection. Although this product features patented or proprietary protection circuitry, damage may occur on devices subjected to high energy ESD. Therefore, proper ESD precautions should be taken to avoid performance degradation or loss of functionality.

PIN CONFIGURATION AND FUNCTION DESCRIPTIONS

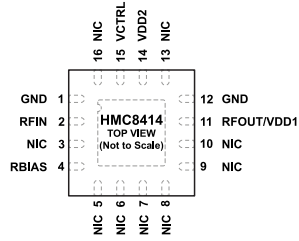

NOTES:
 1. NIC = NO INTERNAL CONNECTION. NOTE THAT THE DATA SHOWN HEREIN WAS MEASURED WITH THESE PINS EXTERNALLY CONNECTED TO RF AND DC GROUND.
 2. EXPOSED PAD. CONNECT THE EXPOSED PAD TO A GROUND PLANE THAT HAS LOW ELECTRICAL AND THERMAL IMPEDANCE.

Figure 2. Pin Configuration

Table 9. Pin Function Descriptions

Pin No.	Mnemonic	Description
1, 12	GND	Ground. Connect to a ground pad that has low electrical and thermal impedance.
2	RFIN	RF Input. The RFIN pin is DC-coupled and matched to 50 Ω. See Figure 4 for the interface schematic.
3, 5 to 10, 13, 16	NIC	No Internal Connection. These pins are not connected internally. For normal operation, connect these pins to ground.
4	RBIAS	Bias Setting Resistor. Connect a resistor between the RBIAS pin and VDD pins (RFOUT/VDD1 and VDD2) to set the quiescent drain current. See Figure 130 for more details.
11	RFOUT/VDD1	RF Output and Drain Bias Voltage. The RF output is DC-coupled and serves as the drain biasing node. Connect a DC bias network to provide the drain current and AC-couple the RF output path.
14	VDD2	Drain Bias Voltage. Connect this pin directly to the supply voltage.
15	VCTRL	Bypass Control. Setting VCTRL to 0 V enables bypass mode. Setting VCTRL to 3 V enables amplifier mode.
	EPAD	Exposed Pad. Connect the exposed pad to a ground plane that has low electrical and thermal impedance.

INTERFACE SCHEMATICS

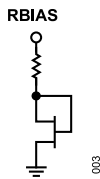

Figure 3. RBIAS Interface Schematic

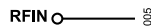

Figure 4. RFIN Interface Schematic



Figure 5. GND Interface Schematic

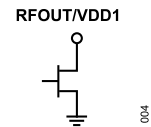

Figure 6. RFOUT/VDD1 Interface Schematic

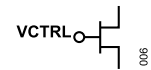

Figure 7. VCTRL Interface Schematic

TYPICAL PERFORMANCE CHARACTERISTICS

INTERNAL AMPLIFIER STATE

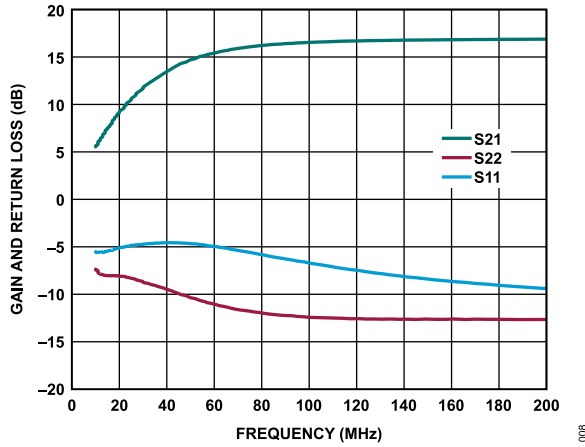

Figure 8. Gain and Return Loss vs. Frequency, $V_{DD} = 5\text{ V}$, $I_{DQ} = 90\text{ mA}$, 10 MHz to 200 MHz

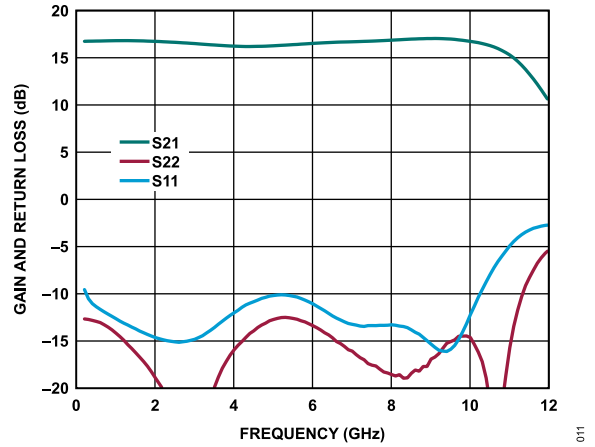

Figure 11. Gain and Return Loss vs. Frequency, $V_{DD} = 5\text{ V}$, $I_{DQ} = 90\text{ mA}$, 200 MHz to 12 GHz

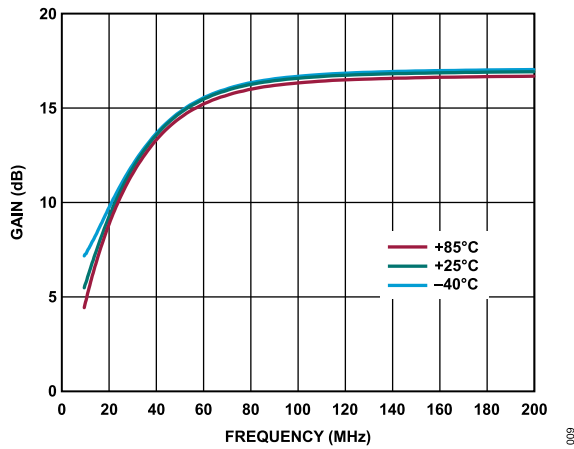

Figure 9. Gain vs. Frequency for Various Temperatures, $V_{DD} = 5\text{ V}$, $I_{DQ} = 90\text{ mA}$, 10 MHz to 200 MHz

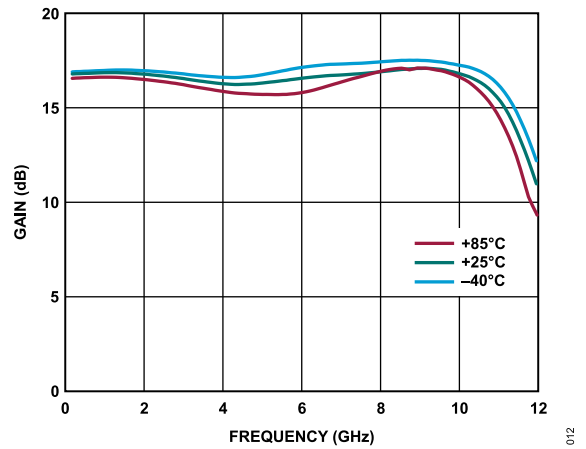

Figure 12. Gain vs. Frequency for Various Temperatures, $V_{DD} = 5\text{ V}$, $I_{DQ} = 90\text{ mA}$, 200 MHz to 12 GHz

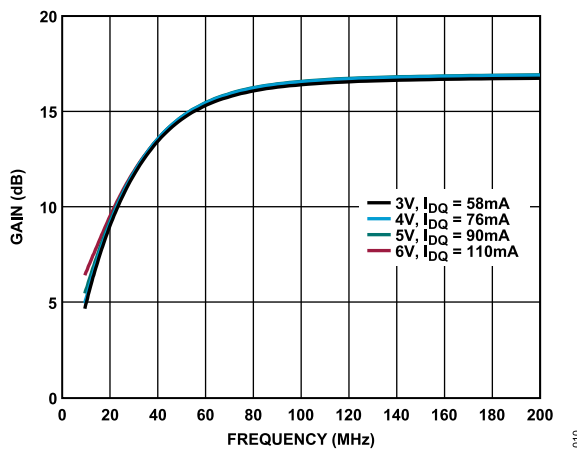

Figure 10. Gain vs. Frequency for Various Supply Voltages and I_{DQ} , $R_{BIAS} = 499\ \Omega$, 10 MHz to 200 MHz

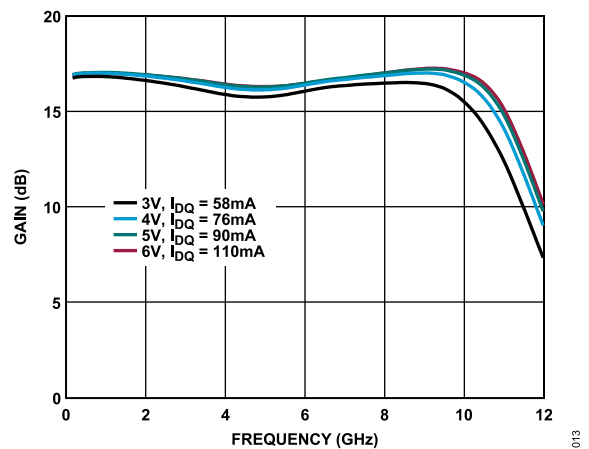

Figure 13. Gain vs. Frequency for Various Supply Voltages and I_{DQ} Values, $R_{BIAS} = 499\ \Omega$, 200 MHz to 12 GHz

TYPICAL PERFORMANCE CHARACTERISTICS

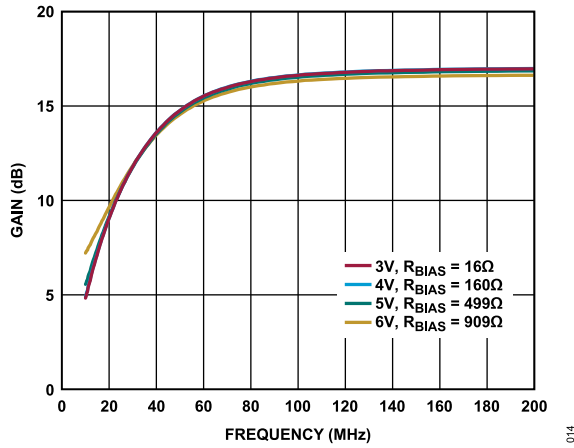

Figure 14. Gain vs. Frequency for Various Supply Voltages and R_{BIAS} , $I_{DQ} = 90\text{ mA}$, 10 MHz to 200 MHz

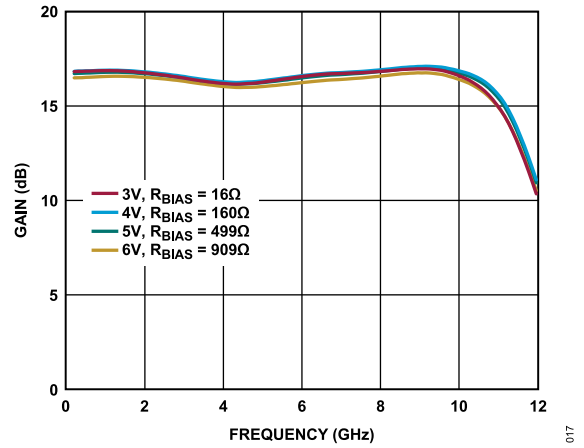

Figure 17. Gain vs. Frequency for Various Supply Voltages and R_{BIAS} Values, $I_{DQ} = 90\text{ mA}$, 200 MHz to 12 GHz

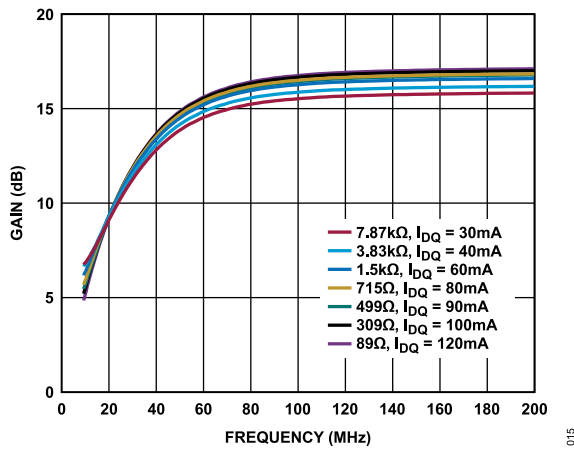

Figure 15. Gain vs. Frequency for Various R_{BIAS} and I_{DQ} Values, $V_{DD} = 5\text{ V}$, 10 MHz to 200 MHz

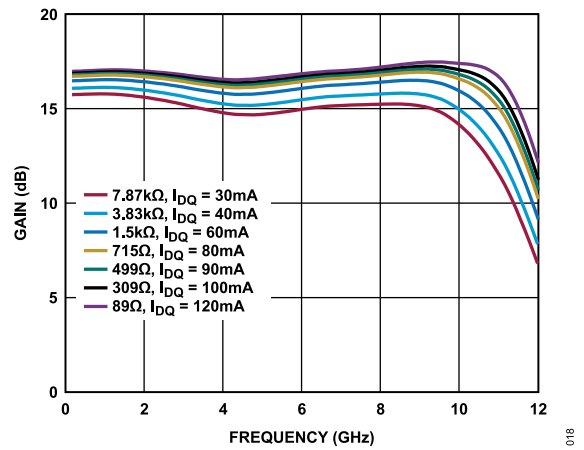

Figure 18. Gain vs. Frequency for Various R_{BIAS} and I_{DQ} Values, $V_{DD} = 5\text{ V}$, 200 MHz to 12 GHz

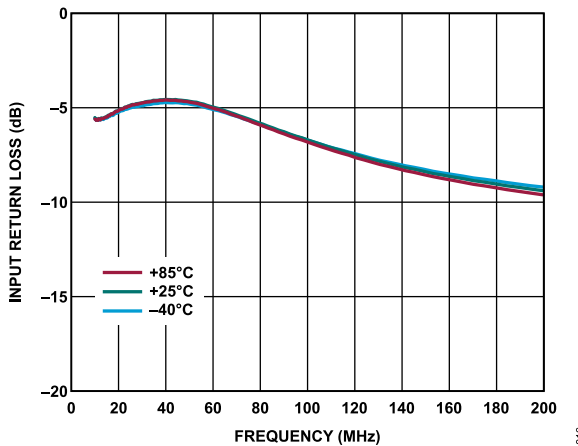

Figure 16. Input Return Loss vs. Frequency for Various Temperatures, $V_{DD} = 5\text{ V}$, $I_{DQ} = 90\text{ mA}$, 10 MHz to 200 MHz

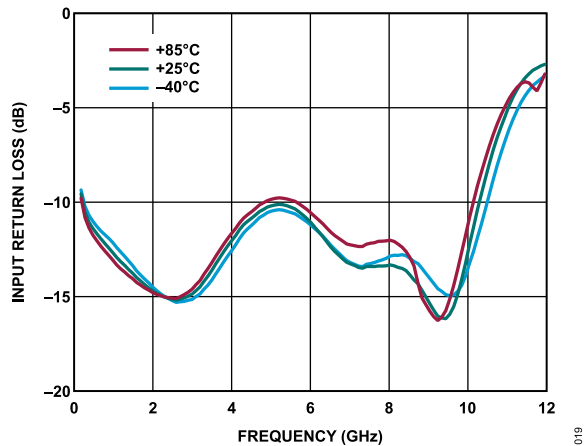

Figure 19. Input Return Loss vs. Frequency for Various Temperatures, $V_{DD} = 5\text{ V}$, $I_{DQ} = 90\text{ mA}$, 200 MHz to 12 GHz

TYPICAL PERFORMANCE CHARACTERISTICS

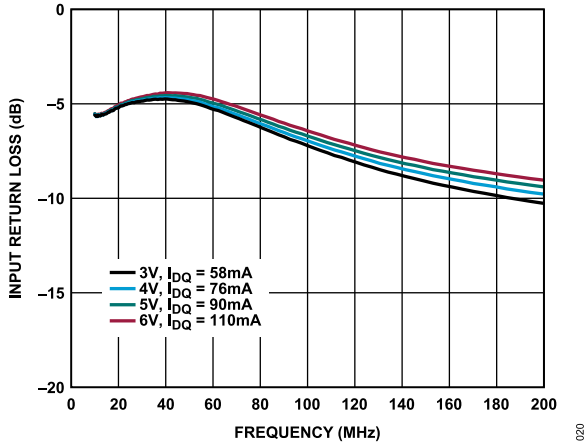

Figure 20. Input Return Loss vs. Frequency for Various Supply Voltages and I_{DQ} Values, $R_{BIAS} = 499 \Omega$, 10 MHz to 200 MHz

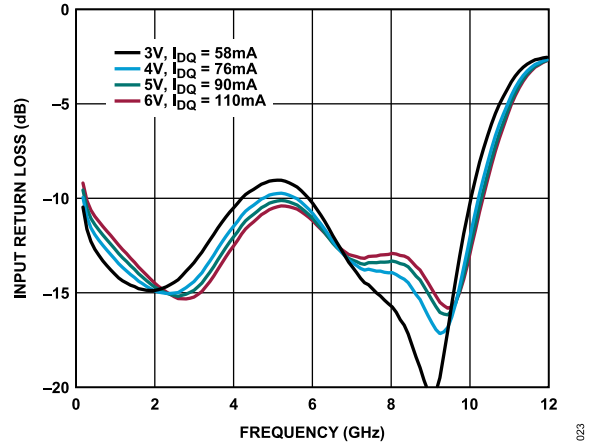

Figure 23. Input Return Loss vs. Frequency for Various Supply Voltages and I_{DQ} Values, $R_{BIAS} = 499 \Omega$, 200 MHz to 12 GHz

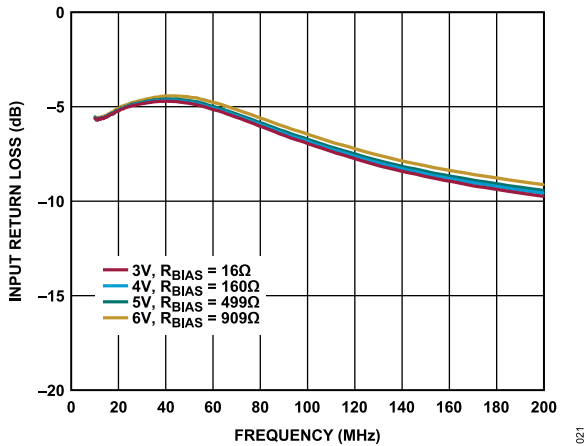

Figure 21. Input Return Loss vs. Frequency for Various Supply Voltages and R_{BIAS} Values, $I_{DQ} = 90 \text{ mA}$, 10 MHz to 200 MHz

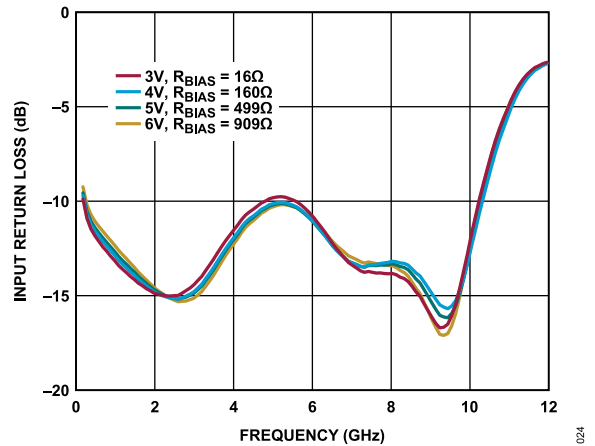

Figure 24. Input Return Loss vs. Frequency for Various Supply Voltages and R_{BIAS} Values, $I_{DQ} = 90 \text{ mA}$, 200 MHz to 12 GHz

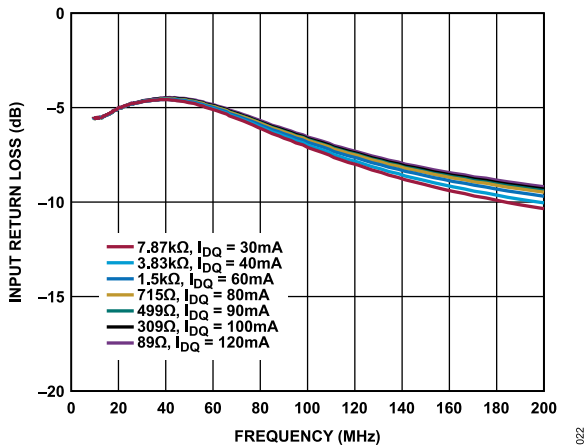

Figure 22. Input Return Loss vs. Frequency for Various R_{BIAS} and I_{DQ} Values, $V_{DD} = 5 \text{ V}$, 10 MHz to 200 MHz

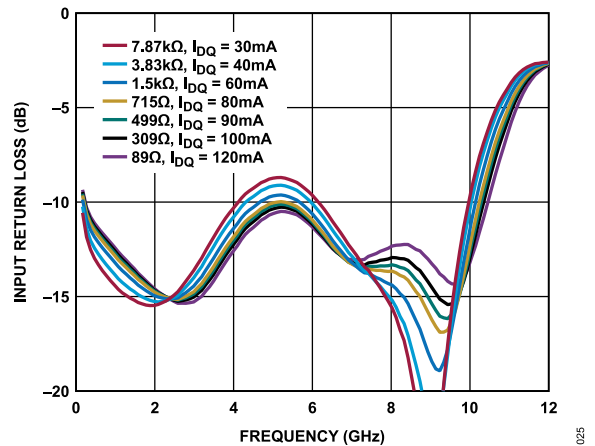

Figure 25. Input Return Loss vs. Frequency for Various R_{BIAS} and I_{DQ} Values, $V_{DD} = 5 \text{ V}$, 200 MHz to 12 GHz

TYPICAL PERFORMANCE CHARACTERISTICS

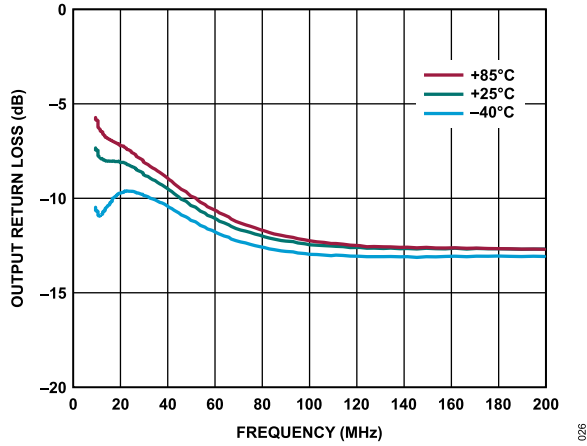

Figure 26. Output Return Loss vs. Frequency for Various Temperatures, $V_{DD} = 5\text{ V}$, $I_{DQ} = 90\text{ mA}$, 10 MHz to 200 MHz

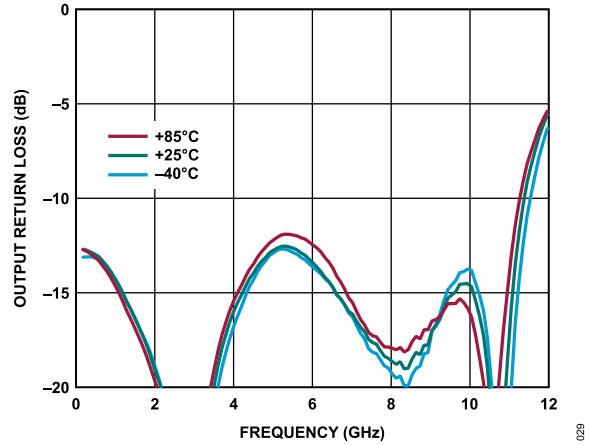

Figure 29. Output Return Loss vs. Frequency for Various Temperatures, $V_{DD} = 5\text{ V}$, $I_{DQ} = 90\text{ mA}$, 200 MHz to 12 GHz

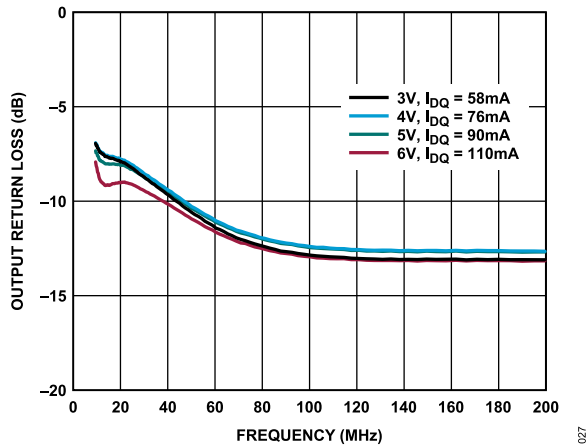

Figure 27. Output Return Loss vs. Frequency for Various Supply Voltages and I_{DQ} Values, $R_{BIAS} = 499\ \Omega$, 10 MHz to 200 MHz

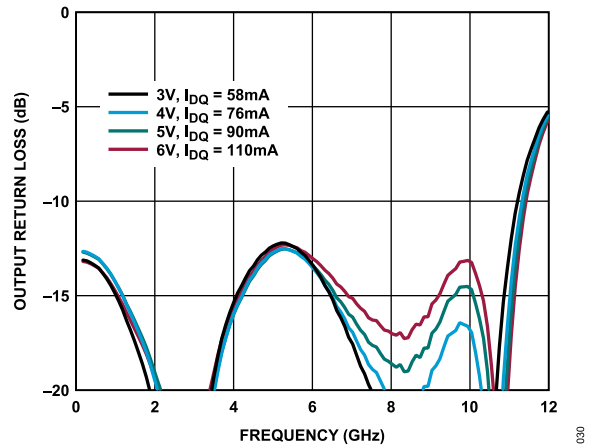

Figure 30. Output Return Loss vs. Frequency for Various Supply Voltages and I_{DQ} Values, $R_{BIAS} = 499\ \Omega$, 200 MHz to 12 GHz

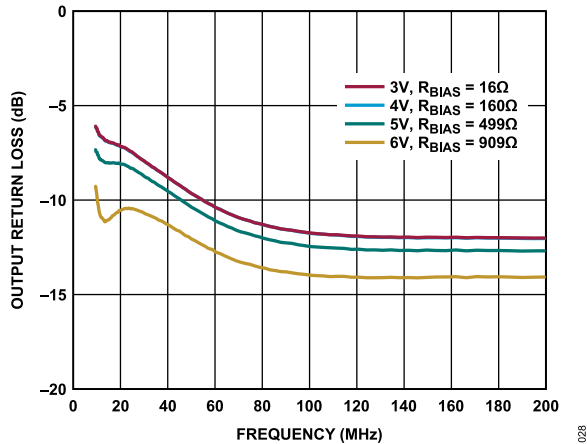

Figure 28. Output Return Loss vs. Frequency for Various Supply Voltages and R_{BIAS} Values, $I_{DQ} = 90\text{ mA}$, 10 MHz to 200 MHz

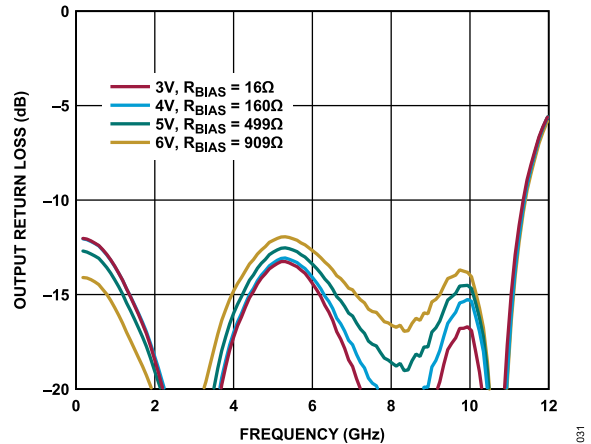

Figure 31. Output Return Loss vs. Frequency for Various Supply Voltages and R_{BIAS} Values, $I_{DQ} = 90\text{ mA}$, 200 MHz to 12 GHz

TYPICAL PERFORMANCE CHARACTERISTICS

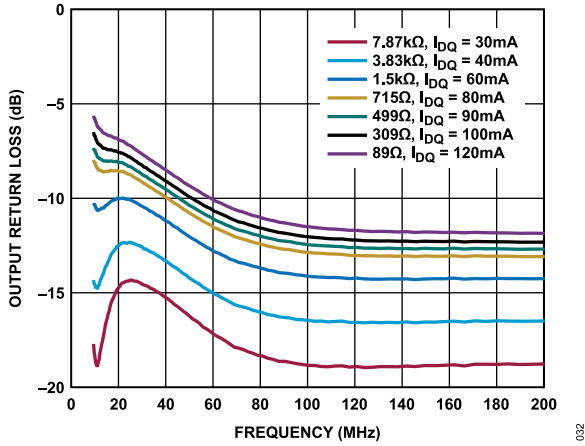

Figure 32. Output Return Loss vs. Frequency for Various R_{BIAS} and I_{DQ} Values, $V_{DD} = 5\text{ V}$, 10 MHz to 200 MHz

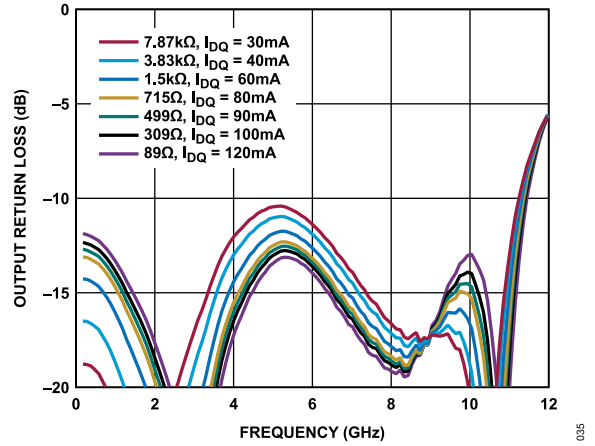

Figure 35. Output Return Loss vs. Frequency for Various R_{BIAS} and I_{DQ} Values, $V_{DD} = 5\text{ V}$, 200 MHz to 12 GHz

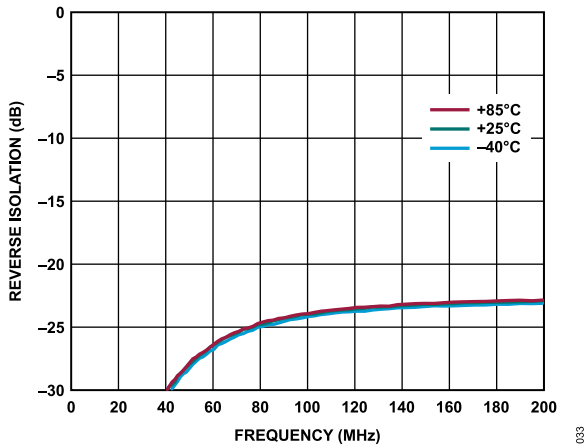

Figure 33. Reverse Isolation vs. Frequency for Various Temperatures, $V_{DD} = 5\text{ V}$, $I_{DQ} = 90\text{ mA}$, 10 MHz to 200 MHz

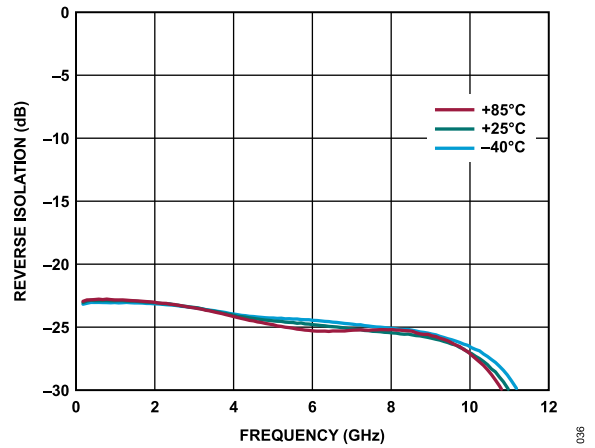

Figure 36. Reverse Isolation vs. Frequency for Various Temperatures, $V_{DD} = 5\text{ V}$, $I_{DQ} = 90\text{ mA}$, 200 MHz to 12 GHz

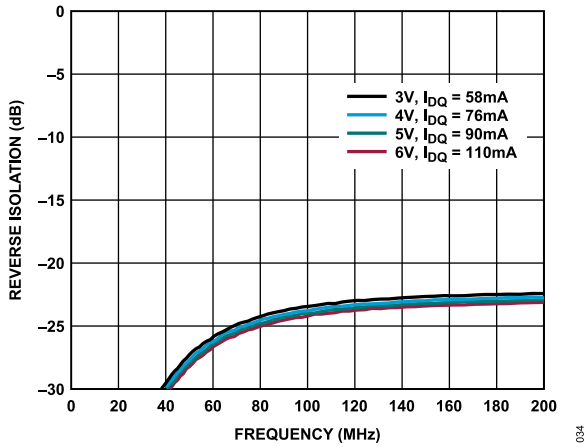

Figure 34. Reverse Isolation vs. Frequency for Various Supply Voltages and I_{DQ} Values, $R_{BIAS} = 499\ \Omega$, 10 MHz to 200 MHz

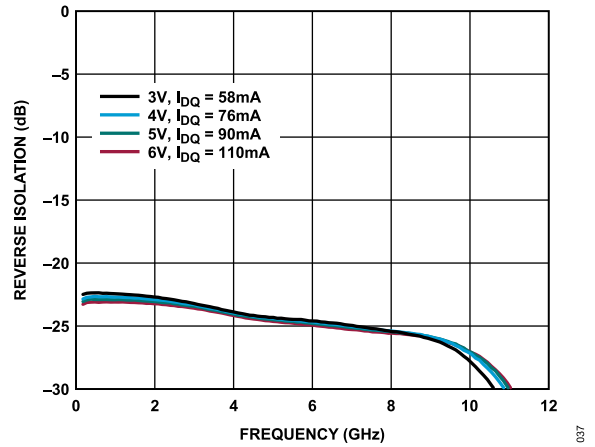

Figure 37. Reverse Isolation vs. Frequency for Various Supply Voltages and I_{DQ} Values, $R_{BIAS} = 499\ \Omega$, 200 MHz to 12 GHz

TYPICAL PERFORMANCE CHARACTERISTICS

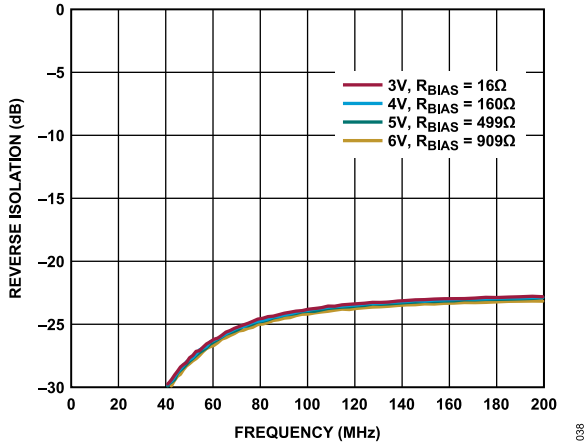

Figure 38. Reverse Isolation vs. Frequency for Various Supply Voltages and R_{BIAS} Values, $I_{DQ} = 90$ mA, 10 MHz to 200 MHz

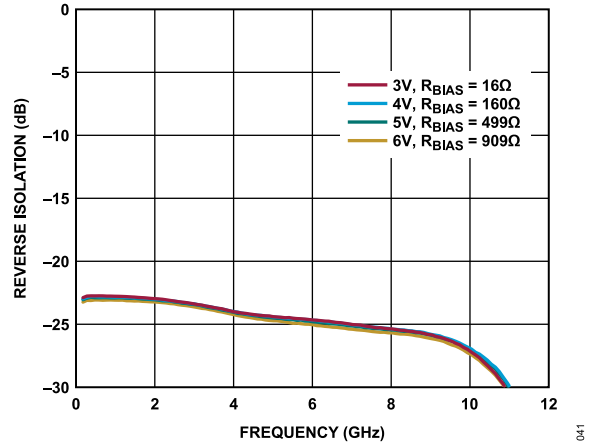

Figure 41. Reverse Isolation vs. Frequency for Various Supply Voltages and R_{BIAS} Values, $I_{DQ} = 90$ mA, 200 MHz to 12 GHz

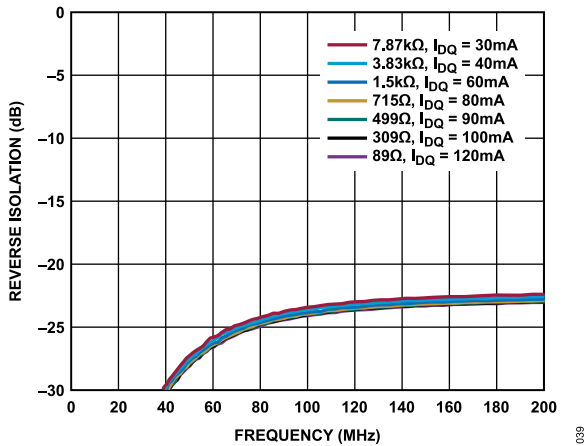

Figure 39. Reverse Isolation vs. Frequency for Various R_{BIAS} and I_{DQ} Values, $V_{DD} = 5$ V, 10 MHz to 200 MHz

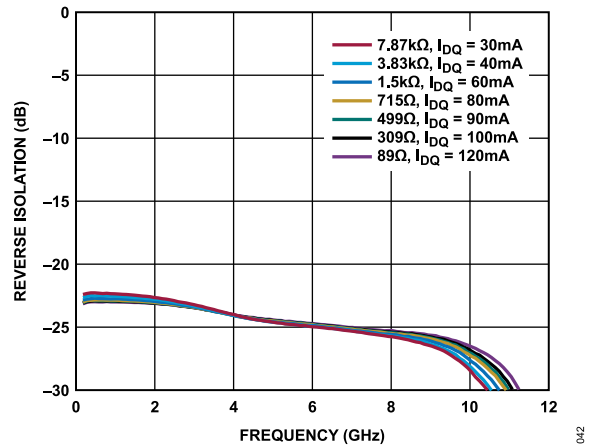

Figure 42. Reverse Isolation vs. Frequency for Various R_{BIAS} and I_{DQ} Values, $V_{DD} = 5$ V, 200 MHz to 12 GHz

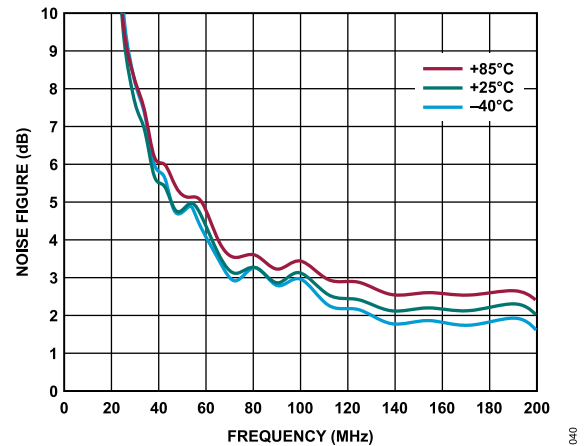

Figure 40. Noise Figure vs. Frequency for Various Temperatures, $V_{DD} = 5$ V, $I_{DQ} = 90$ mA, 10 MHz to 200 MHz

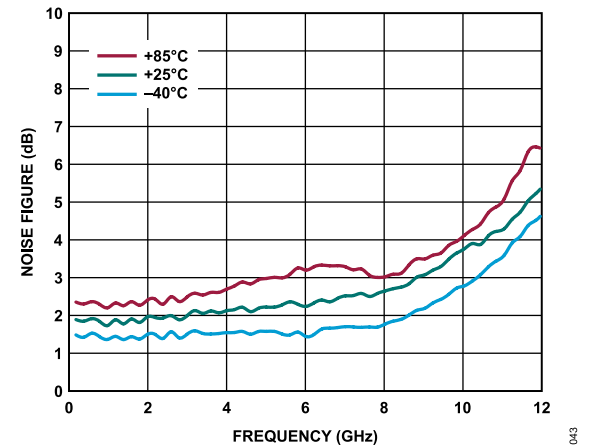

Figure 43. Noise Figure vs. Frequency for Various Temperatures, $V_{DD} = 5$ V, $I_{DQ} = 90$ mA, 200 MHz to 12 GHz

TYPICAL PERFORMANCE CHARACTERISTICS

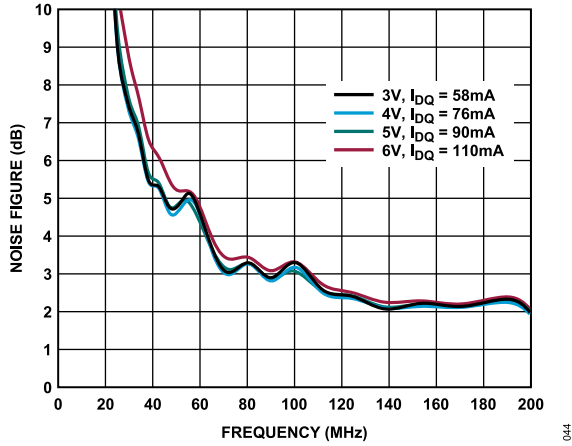

Figure 44. Noise Figure vs. Frequency for Various Supply Voltages and I_{DQ} Values, $R_{BIAS} = 499 \Omega$, 10 MHz to 200 MHz

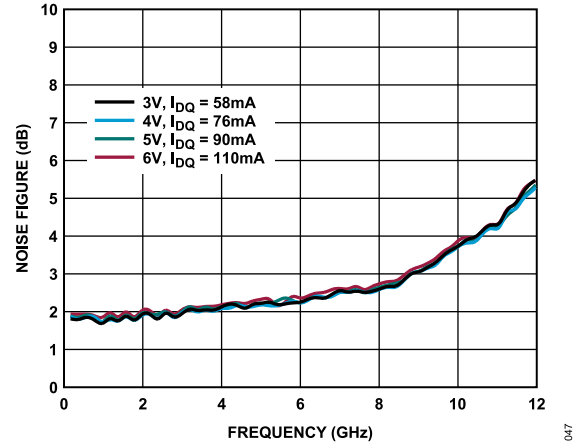

Figure 47. Noise Figure vs. Frequency for Various Supply Voltages and I_{DQ} Values, $R_{BIAS} = 499 \Omega$, 200 MHz to 12 GHz

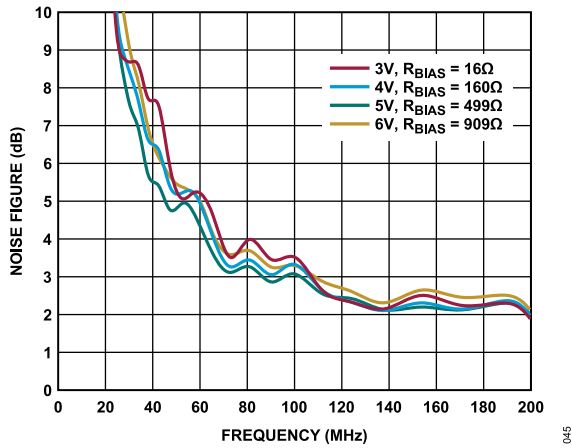

Figure 45. Noise Figure vs. Frequency for Various Supply Voltages and R_{BIAS} Values, $I_{DQ} = 90 \text{ mA}$, 10 MHz to 200 MHz

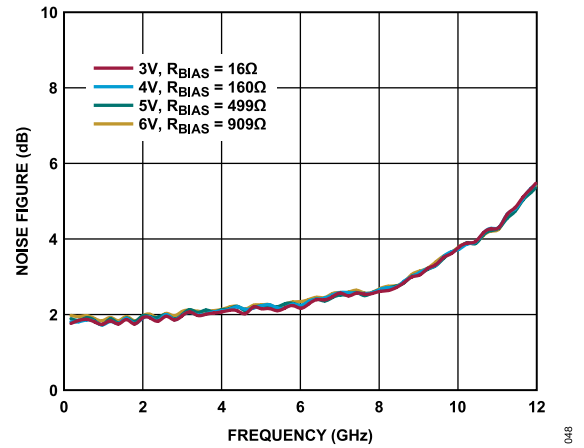

Figure 48. Noise Figure vs. Frequency for Various Supply Voltages and R_{BIAS} Values, $I_{DQ} = 90 \text{ mA}$, 200 MHz to 12 GHz

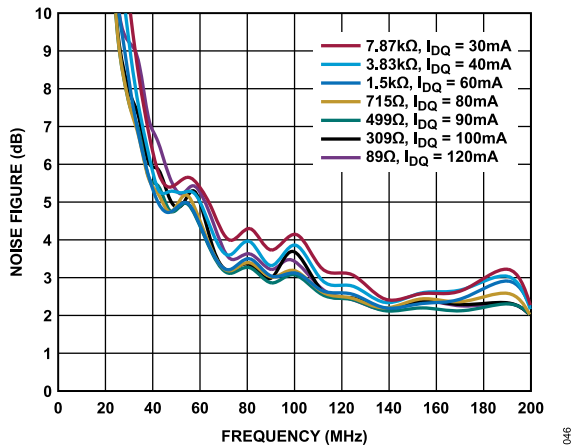

Figure 46. Noise Figure vs. Frequency for Various R_{BIAS} and I_{DQ} Values, $V_{DD} = 5 \text{ V}$, 10 MHz to 200 MHz

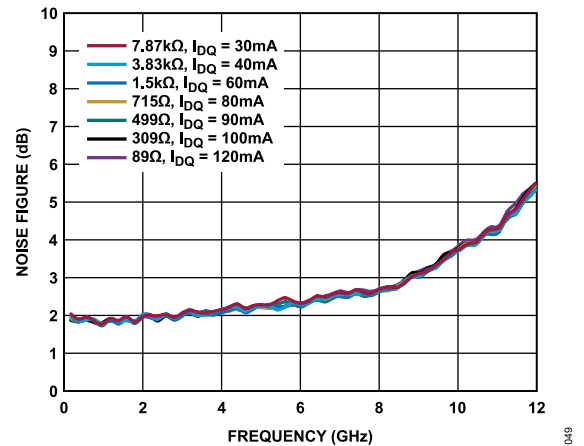

Figure 49. Noise Figure vs. Frequency for Various R_{BIAS} and I_{DQ} Values, $V_{DD} = 5 \text{ V}$, 200 MHz to 12 GHz

TYPICAL PERFORMANCE CHARACTERISTICS

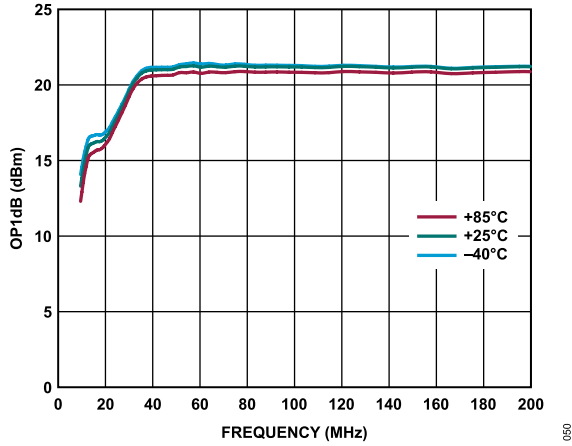

Figure 50. OP1dB vs. Frequency for Various Temperatures, $V_{DD} = 5\text{ V}$, $I_{DQ} = 90\text{ mA}$, 10 MHz to 200 MHz

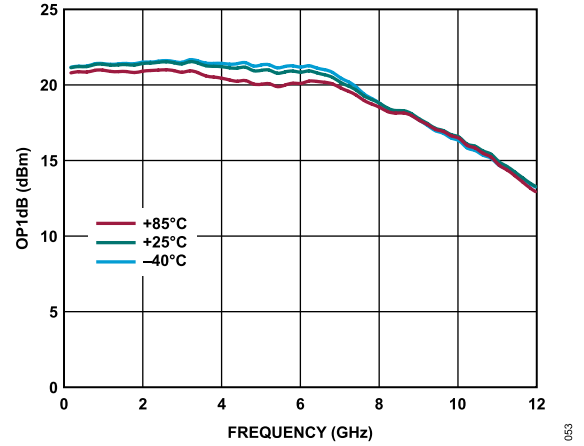

Figure 53. OP1dB vs. Frequency for Various Temperatures, $V_{DD} = 5\text{ V}$, $I_{DQ} = 90\text{ mA}$, 200 MHz to 12 GHz

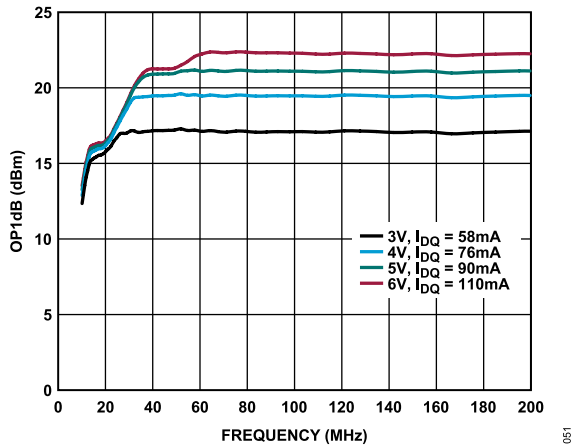

Figure 51. OP1dB vs. Frequency for Various Supply Voltages and I_{DQ} Values, $R_{BIAS} = 499\ \Omega$, 10 MHz to 200 MHz

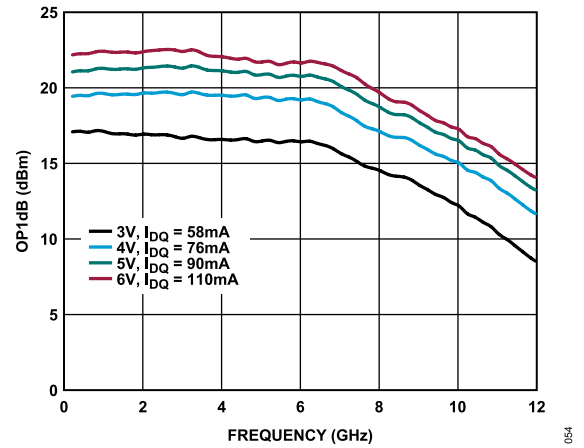

Figure 54. OP1dB vs. Frequency for Various Supply Voltages and I_{DQ} Values, $R_{BIAS} = 499\ \Omega$, 200 MHz to 12 GHz

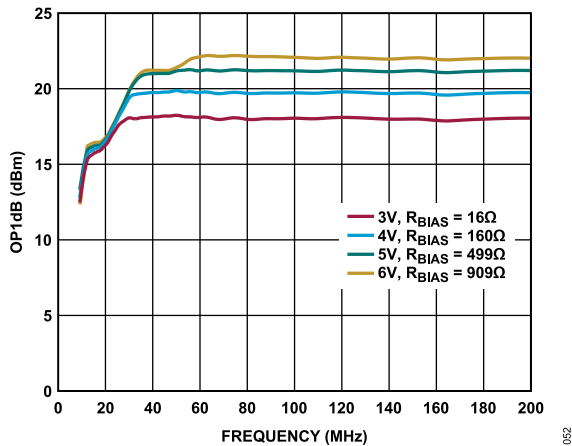

Figure 52. OP1dB vs. Frequency for Various Supply Voltages and R_{BIAS} Values, $I_{DQ} = 90\text{ mA}$, 10 MHz to 200 MHz

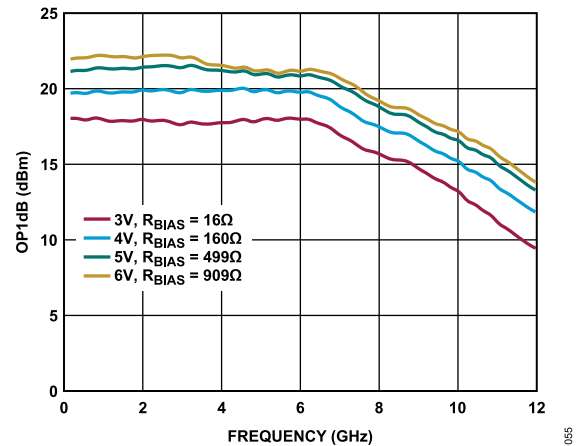

Figure 55. OP1dB vs. Frequency for Various Supply Voltages and R_{BIAS} Values, $I_{DQ} = 90\text{ mA}$, 200 MHz to 12 GHz

TYPICAL PERFORMANCE CHARACTERISTICS

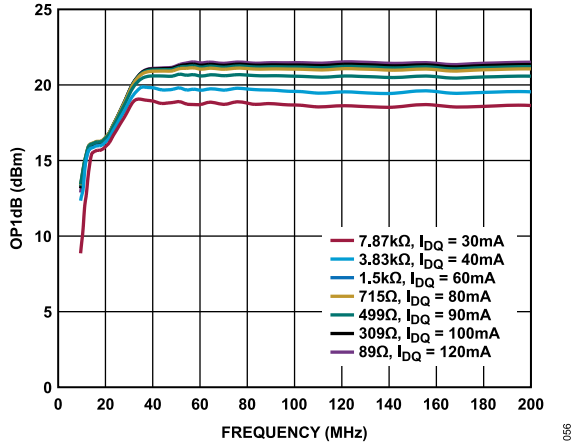

Figure 56. OP1dB vs. Frequency for Various R_{BIAS} and I_{DQ} Values, $V_{DD} = 5 V$, 10 MHz to 200 MHz

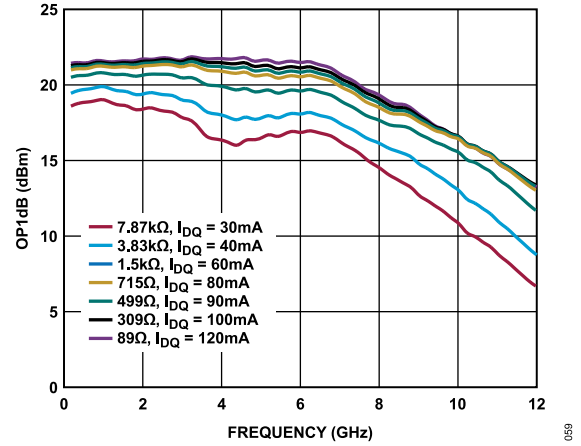

Figure 59. OP1dB vs. Frequency for Various R_{BIAS} and I_{DQ} Values, $V_{DD} = 5 V$, 200 MHz to 12 GHz

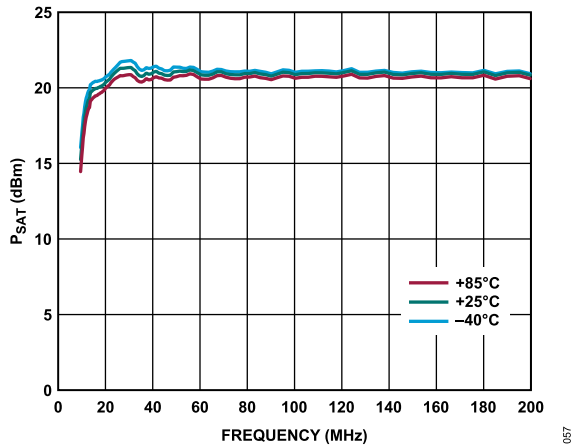

Figure 57. P_{SAT} vs. Frequency for Various Temperatures, $V_{DD} = 5 V$, $I_{DQ} = 90$ mA, 10 MHz to 200 MHz

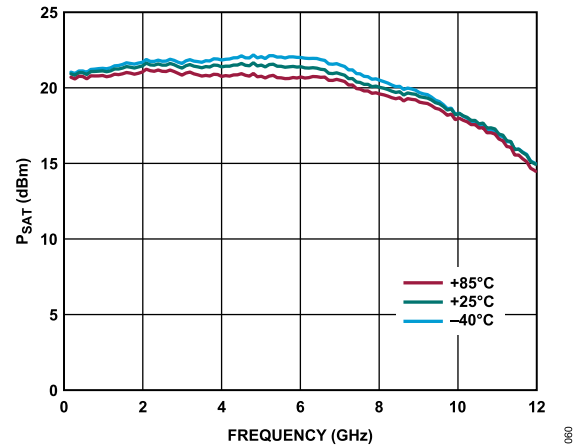

Figure 60. P_{SAT} vs. Frequency for Various Temperatures, $V_{DD} = 5 V$, $I_{DQ} = 90$ mA, 200 MHz to 12 GHz

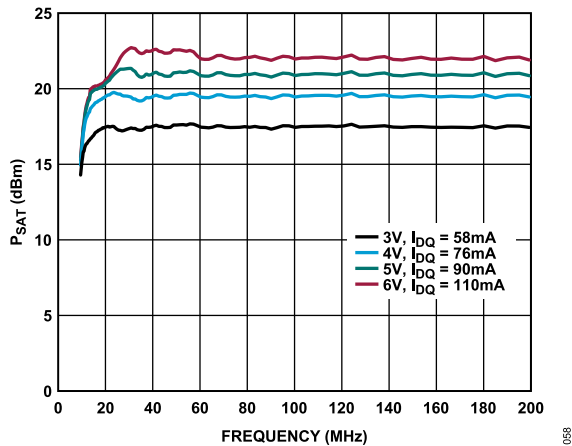

Figure 58. P_{SAT} vs. Frequency for Various Supply Voltages and I_{DQ} Values, $R_{BIAS} = 499 \Omega$, 10 MHz to 200 MHz

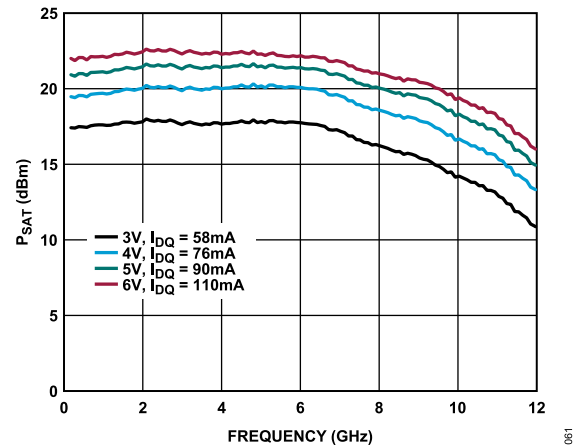

Figure 61. P_{SAT} vs. Frequency for Various Supply Voltages and I_{DQ} Values, $R_{BIAS} = 499 \Omega$, 200 MHz to 12 GHz

TYPICAL PERFORMANCE CHARACTERISTICS

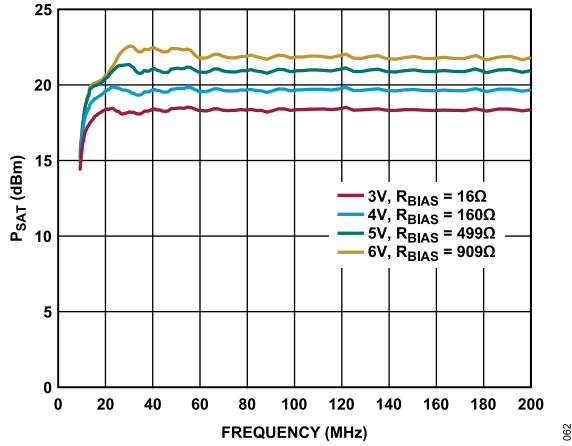

Figure 62. P_{SAT} vs. Frequency for Various Supply Voltages and R_{BIAS} Values, $I_{DQ} = 90$ mA, 10 MHz to 200 MHz

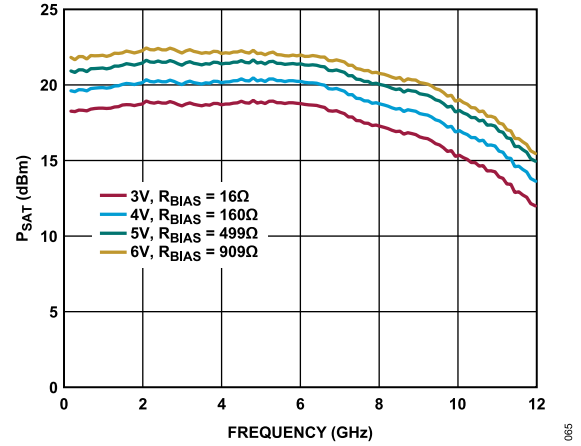

Figure 65. P_{SAT} vs. Frequency for Various Supply Voltages and R_{BIAS} Values, $I_{DQ} = 90$ mA, 200 MHz to 12 GHz

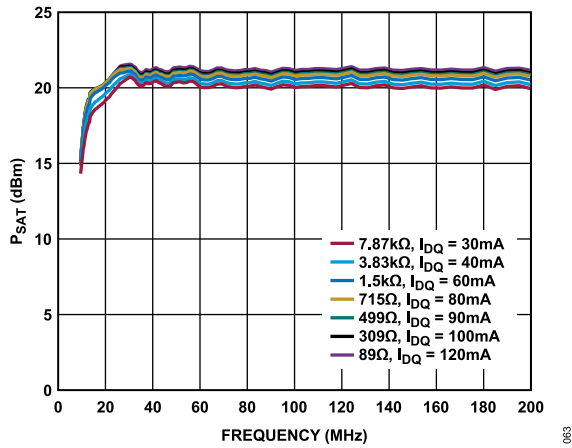

Figure 63. P_{SAT} vs. Frequency for Various R_{BIAS} and I_{DQ} Values, $V_{DD} = 5$ V, 10 MHz to 200 MHz

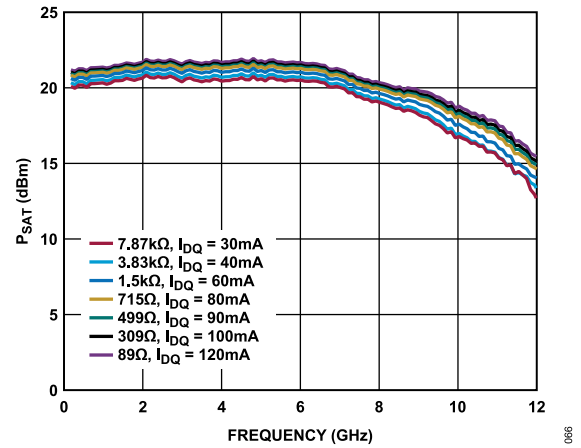

Figure 66. P_{SAT} vs. Frequency for Various R_{BIAS} and I_{DQ} Values, $V_{DD} = 5$ V, 200 MHz to 12 GHz

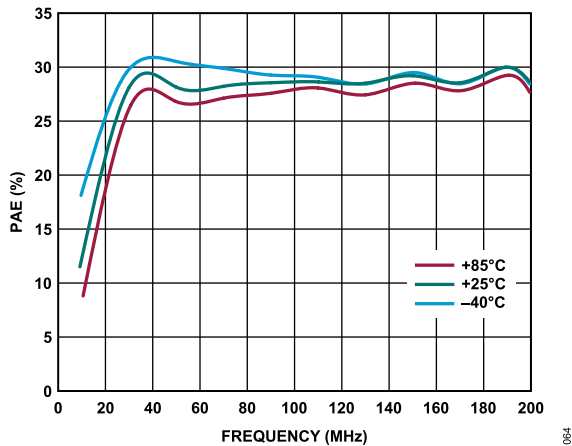

Figure 64. PAE Measured at P_{SAT} vs. Frequency for Various Temperatures, $V_{DD} = 5$ V, $I_{DQ} = 90$ mA, 10 MHz to 200 MHz

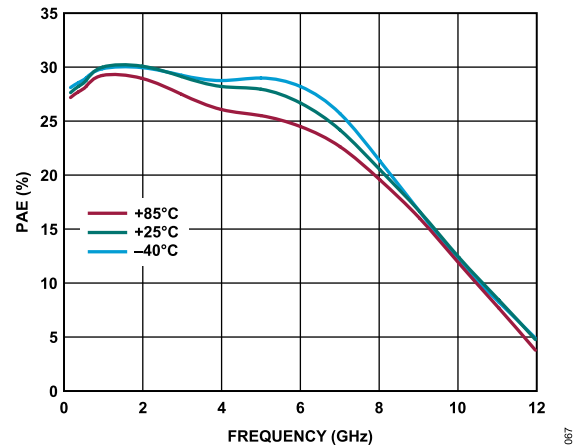

Figure 67. PAE Measured at P_{SAT} vs. Frequency for Various Temperatures, $V_{DD} = 5$ V, $I_{DQ} = 90$ mA, 200 MHz to 12 GHz

TYPICAL PERFORMANCE CHARACTERISTICS

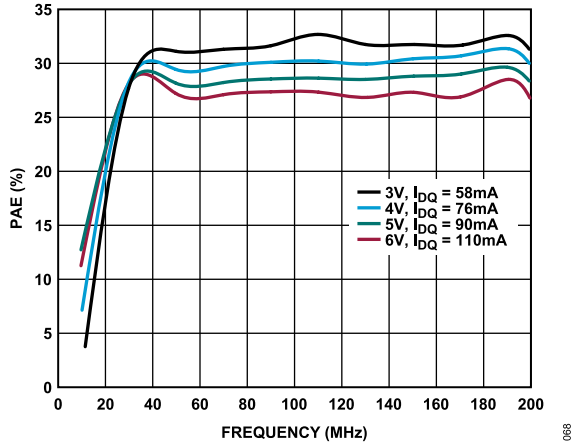

Figure 68. PAE Measured at P_{SAT} vs. Frequency for Various Supply Voltages and I_{DQ} Values, $R_{BIAS} = 499 \Omega$, 10 MHz to 200 MHz

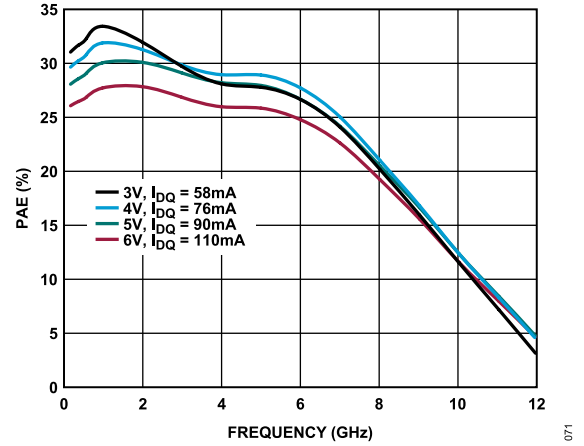

Figure 71. PAE Measured at P_{SAT} vs. Frequency for Various Supply Voltages and I_{DQ} Values, $R_{BIAS} = 499 \Omega$, 200 MHz to 12 GHz

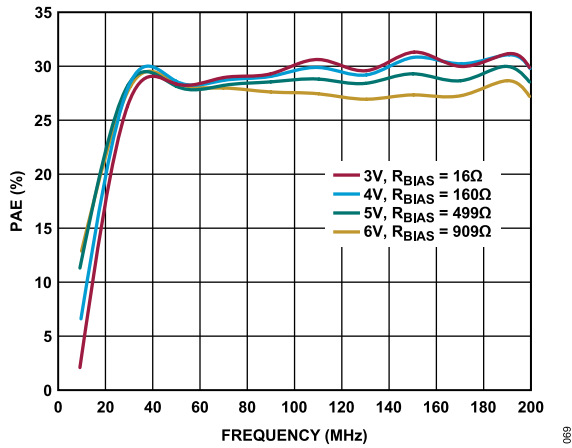

Figure 69. PAE Measured at P_{SAT} vs. Frequency for Various Supply Voltages and R_{BIAS} Values, $I_{DQ} = 90 \text{ mA}$, 10 MHz to 200 MHz

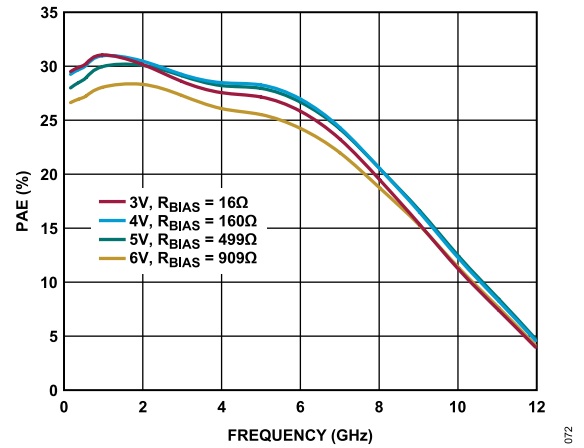

Figure 72. PAE Measured at P_{SAT} vs. Frequency for Various Supply Voltages and R_{BIAS} Values, $I_{DQ} = 90 \text{ mA}$, 200 MHz to 12 GHz

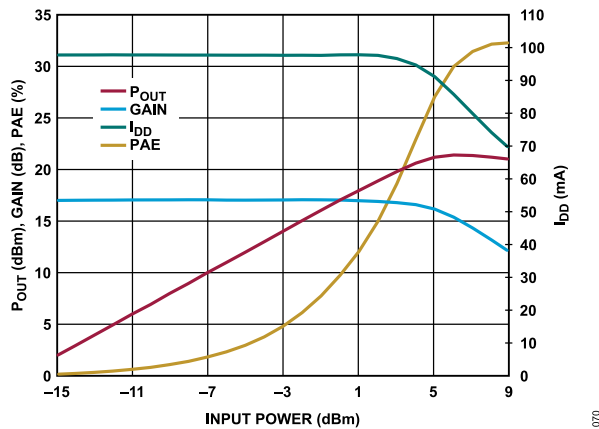

Figure 70. P_{OUT} , Gain, PAE, and I_{DD} vs. P_{IN} at 1 GHz, $V_{DD} = 5 \text{ V}$, $R_{BIAS} = 499 \Omega$

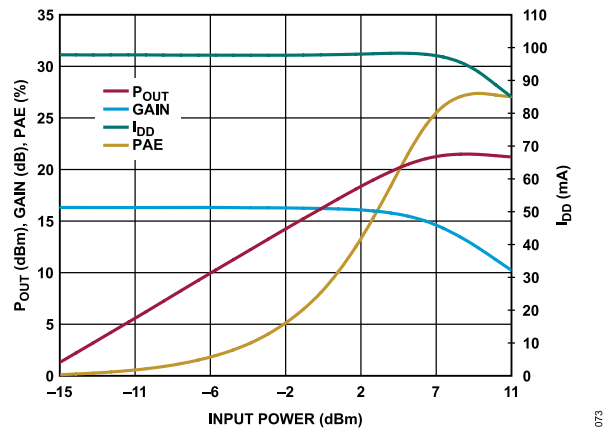

Figure 73. P_{OUT} , Gain, PAE, and I_{DD} vs. P_{IN} at 4 GHz, $V_{DD} = 5 \text{ V}$, $R_{BIAS} = 499 \Omega$

TYPICAL PERFORMANCE CHARACTERISTICS

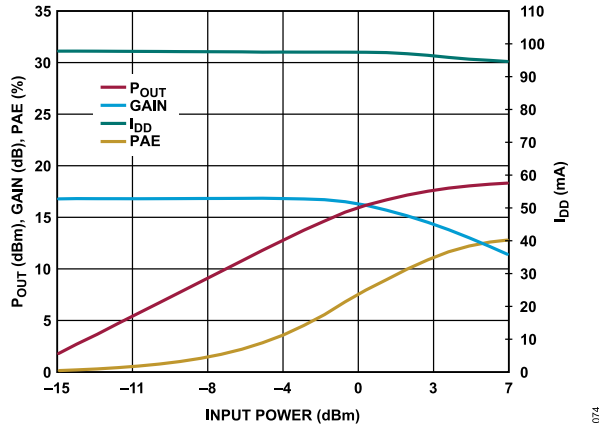

Figure 74. P_{OUT} , Gain, PAE, and I_{DD} vs. P_{IN} at 8 GHz, $V_{DD} = 5$ V, $R_{BIAS} = 499 \Omega$

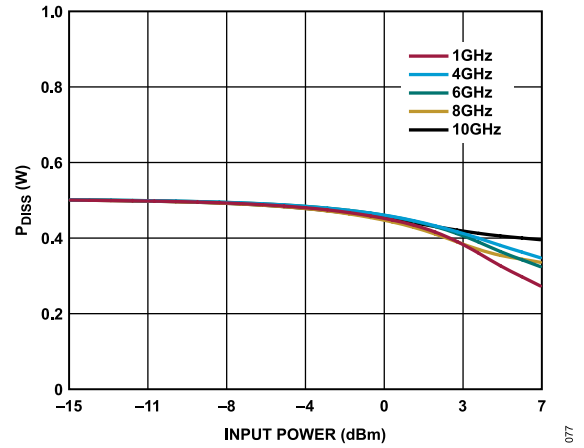

Figure 77. P_{DISS} vs. P_{IN} at Various Frequencies at 85°C, $V_{DD} = 5$ V, $I_{DQ} = 90$ mA

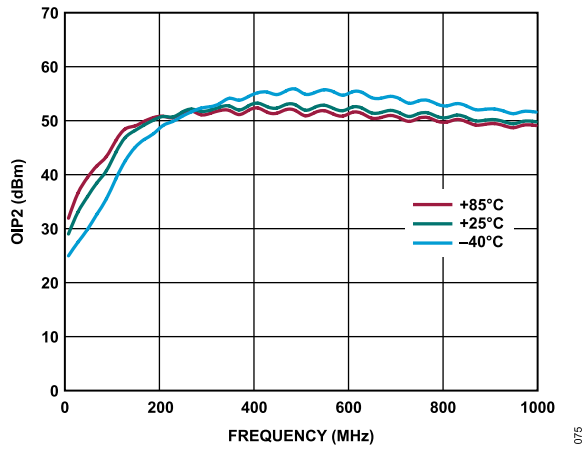

Figure 75. OIP2 vs. Frequency for Various Temperatures, $V_{DD} = 5$ V, $I_{DQ} = 90$ mA, 10 MHz to 1 GHz

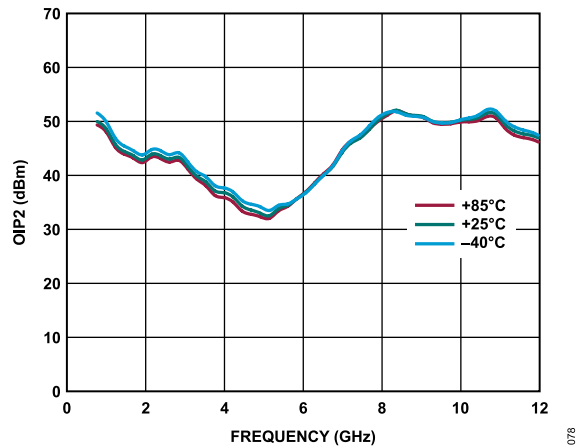

Figure 78. OIP2 vs. Frequency for Various Temperatures, $V_{DD} = 5$ V, $I_{DQ} = 90$ mA, 1 GHz to 12 GHz

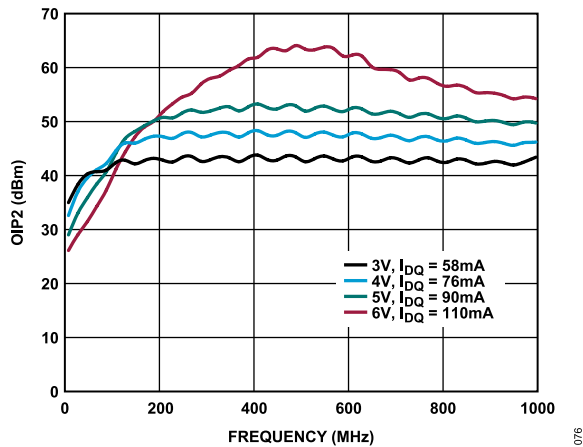

Figure 76. OIP2 vs. Frequency for Various Supply Voltages and I_{DQ} Values, $R_{BIAS} = 499 \Omega$, 10 MHz to 1 GHz

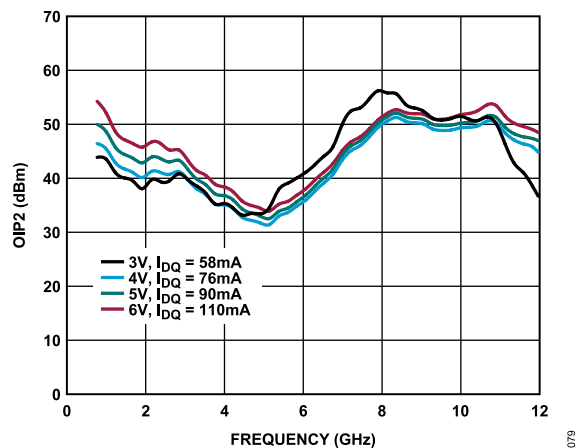

Figure 79. OIP2 vs. Frequency for Various Supply Voltages and I_{DQ} Values, $R_{BIAS} = 499 \Omega$, 1 GHz to 12 GHz

TYPICAL PERFORMANCE CHARACTERISTICS

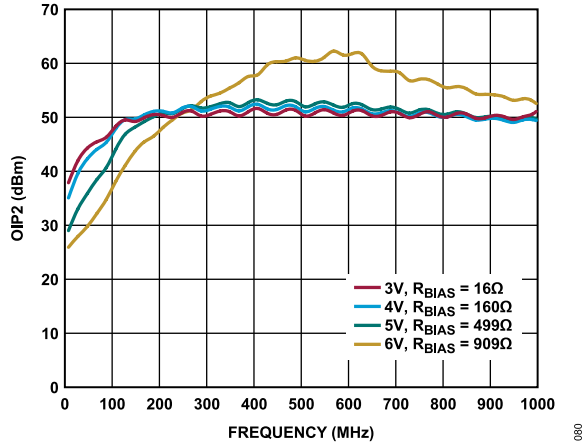

Figure 80. OIP2 vs. Frequency for Various Supply Voltages and R_{BIAS} Values, $I_{DQ} = 90$ mA, 10 MHz to 1 GHz

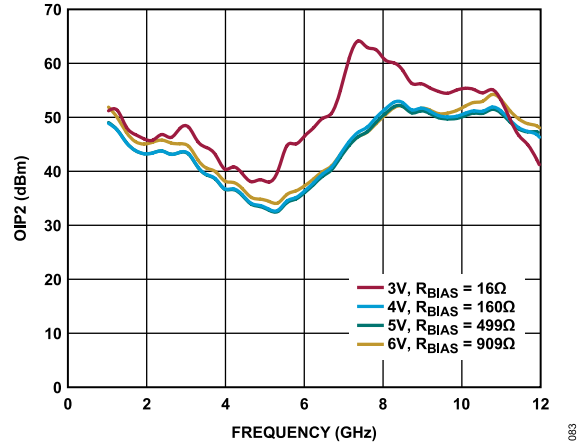

Figure 83. OIP2 vs. Frequency for Various Supply Voltages and R_{BIAS} Values, $I_{DQ} = 90$ mA, 1 GHz to 12 GHz

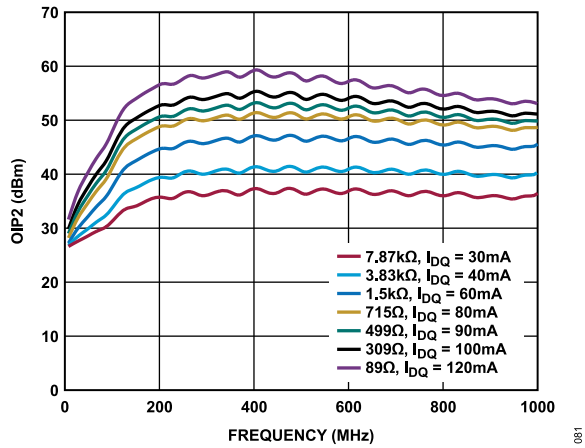

Figure 81. OIP2 vs. Frequency for Various R_{BIAS} and I_{DQ} Values, $V_{DD} = 5$ V, 10 MHz to 1 GHz

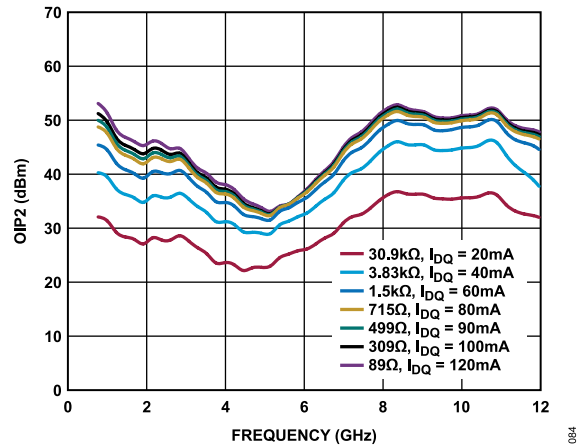

Figure 84. OIP2 vs. Frequency for Various R_{BIAS} and I_{DQ} Values, $V_{DD} = 5$ V, 1 GHz to 12 GHz

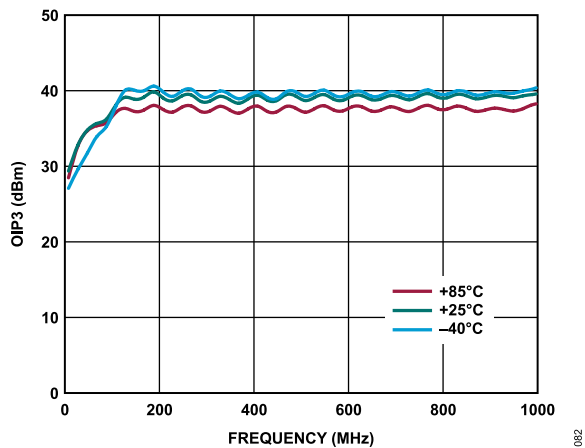

Figure 82. OIP3 vs. Frequency for Various Temperatures, $V_{DD} = 5$ V, $I_{DQ} = 90$ mA, 10 MHz to 1 GHz

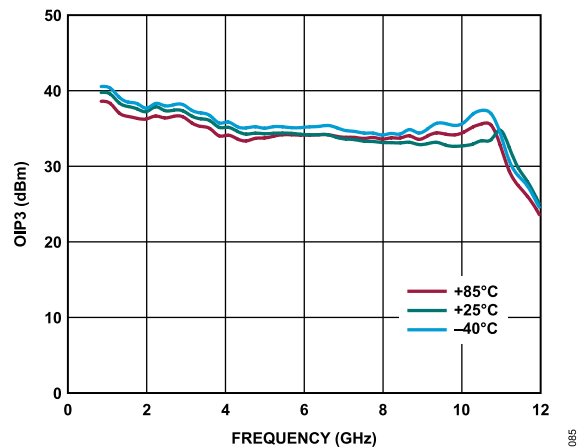

Figure 85. OIP3 vs. Frequency for Various Temperatures, $V_{DD} = 5$ V, $I_{DQ} = 90$ mA, 1 GHz to 12 GHz

TYPICAL PERFORMANCE CHARACTERISTICS

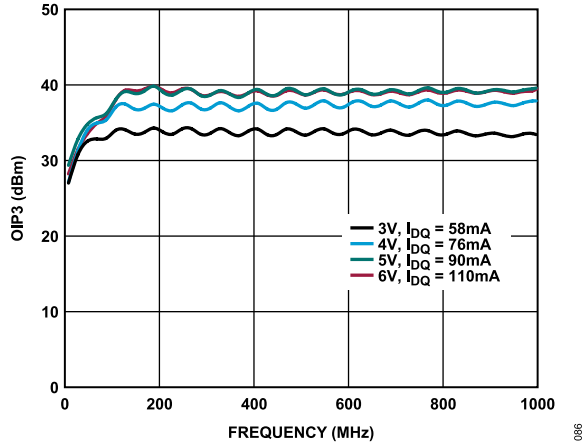

Figure 86. OIP3 vs. Frequency for Various Supply Voltages and I_{DQ} Values, $R_{BIAS} = 499 \Omega$, 10 MHz to 1 GHz

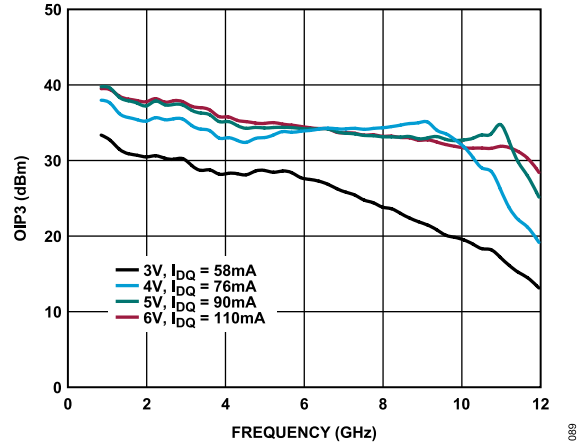

Figure 89. OIP3 vs. Frequency for Various Supply Voltages and I_{DQ} Values, $R_{BIAS} = 499 \Omega$, 1 GHz to 12 GHz

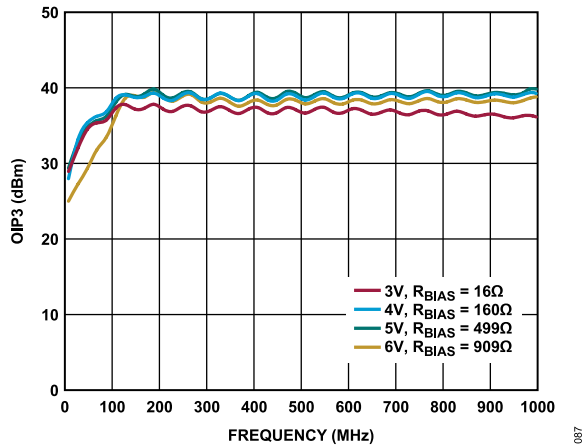

Figure 87. OIP3 vs. Frequency for Various Supply Voltages and R_{BIAS} Values, $I_{DQ} = 90 \text{ mA}$, 10 MHz to 1 GHz

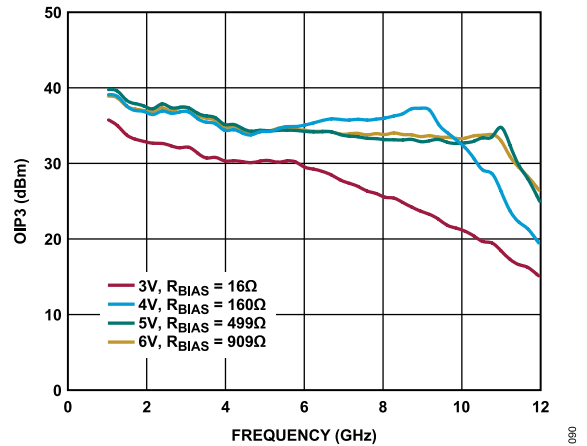

Figure 90. OIP3 vs. Frequency for Various Supply Voltages and R_{BIAS} Values, $I_{DQ} = 90 \text{ mA}$, 1 GHz to 12 GHz

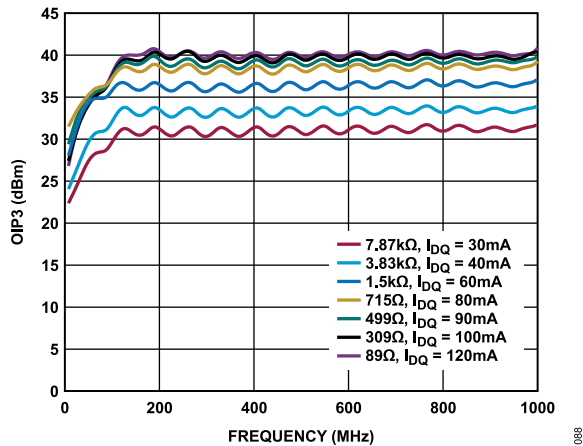

Figure 88. OIP3 vs. Frequency for Various R_{BIAS} and I_{DQ} Values, $V_{DD} = 5 \text{ V}$, 10 MHz to 1 GHz

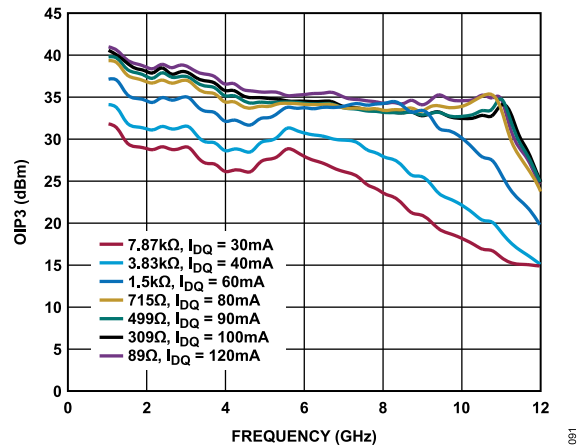

Figure 91. OIP3 vs. Frequency for Various R_{BIAS} and I_{DQ} Values, $V_{DD} = 5 \text{ V}$, 1 GHz to 12 GHz

TYPICAL PERFORMANCE CHARACTERISTICS

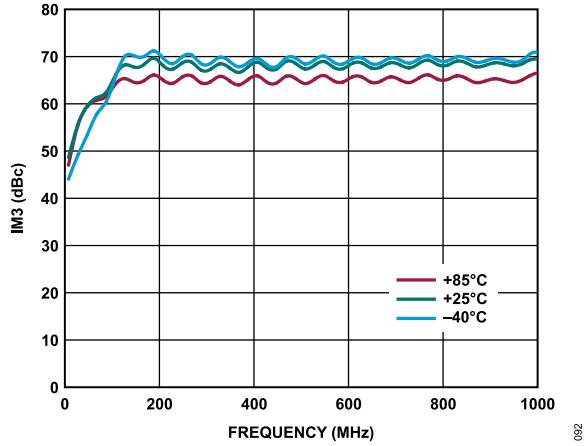

Figure 92. IM3 vs. Frequency for Various Temperatures, $V_{DD} = 5\text{ V}$, $I_{DQ} = 90\text{ mA}$, 10 MHz to 1 GHz

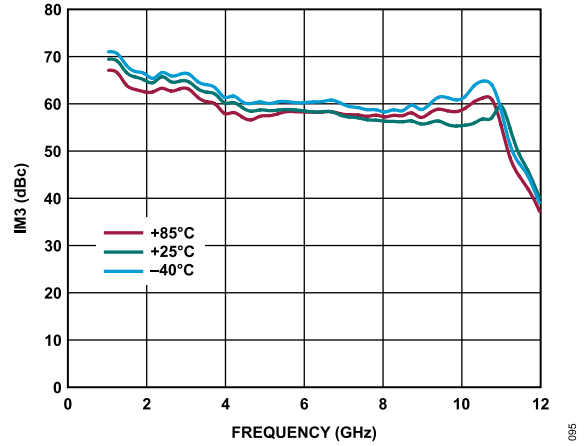

Figure 95. IM3 vs. Frequency for Various Temperatures, $V_{DD} = 5\text{ V}$, $I_{DQ} = 90\text{ mA}$, 1 GHz to 12 GHz

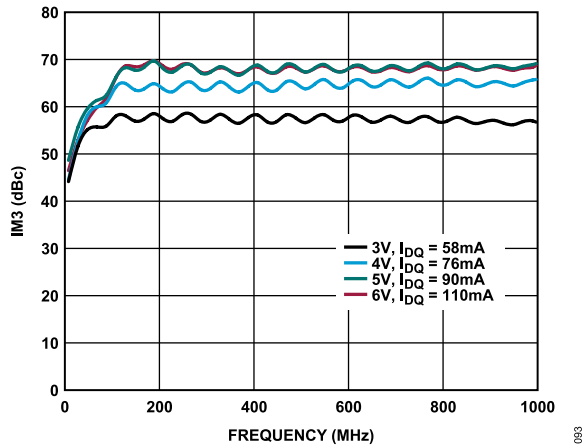

Figure 93. IM3 vs. Frequency for Various Supply Voltages and I_{DQ} Values, $R_{BIAS} = 499\ \Omega$, 10 MHz to 1 GHz

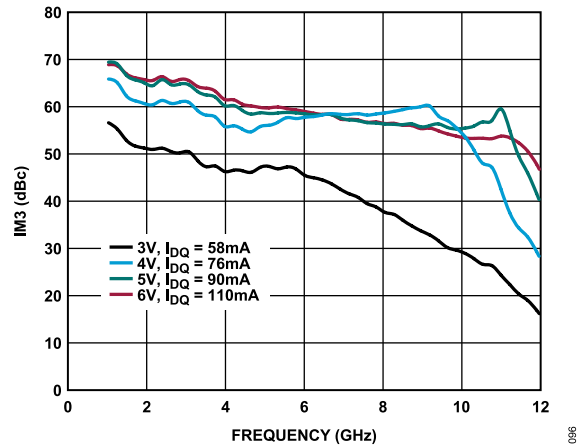

Figure 96. IM3 vs. Frequency for Various Supply Voltages and I_{DQ} Values, $R_{BIAS} = 499\ \Omega$, 1 GHz to 12 GHz

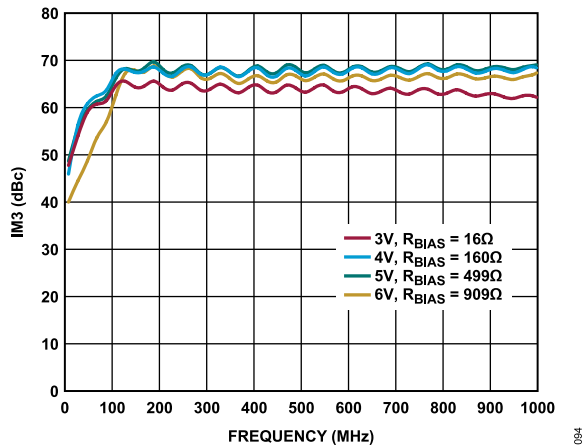

Figure 94. IM3 vs. Frequency for Various Supply Voltages and R_{BIAS} Values, $I_{DQ} = 90\text{ mA}$, 10 MHz to 1 GHz

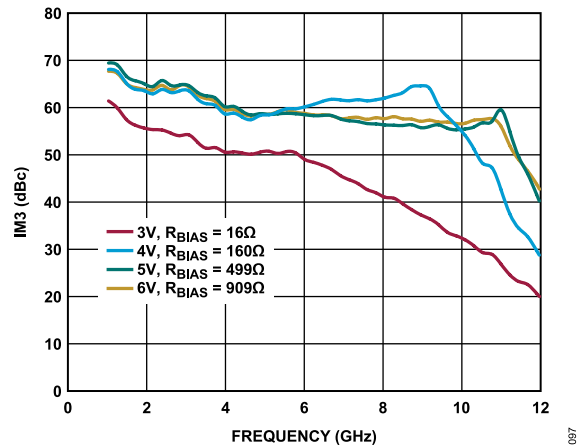

Figure 97. IM3 vs. Frequency for Various Supply Voltages and R_{BIAS} Values, $I_{DQ} = 90\text{ mA}$, 1 GHz to 12 GHz

TYPICAL PERFORMANCE CHARACTERISTICS

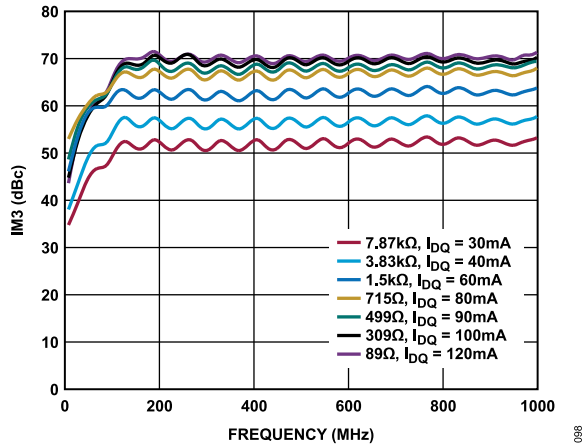

Figure 98. IM3 vs. Frequency for Various R_{BIAS} and I_{DQ} Values, $V_{DD} = 5 V$, 10 MHz to 1 GHz

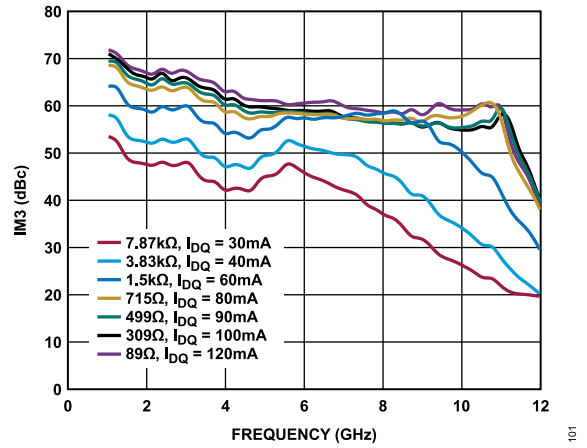

Figure 101. IM3 vs. Frequency for Various R_{BIAS} and I_{DQ} Values, $V_{DD} = 5 V$, 1 GHz to 12 GHz

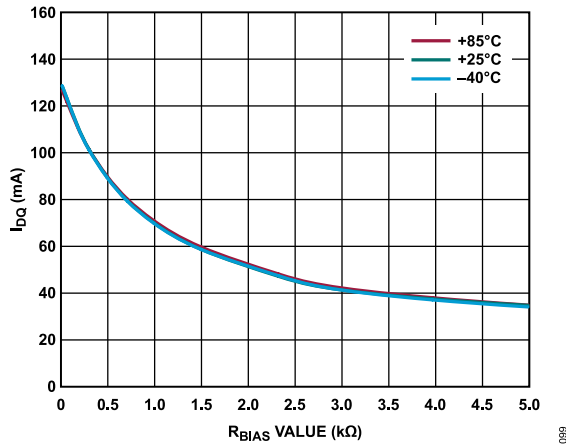

Figure 99. I_{DQ} vs R_{BIAS} for Various Temperatures, $V_{DD} = 5 V$, R_{BIAS} Range = 0 Ω to 5.0 k Ω

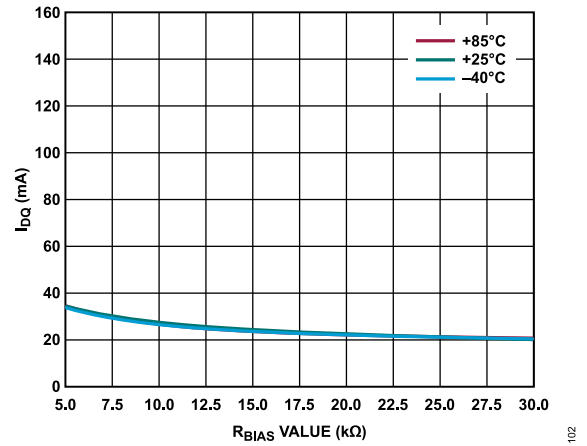

Figure 102. I_{DQ} vs R_{BIAS} for Various Temperatures, $V_{DD} = 5 V$, R_{BIAS} Range = 5.0 k Ω to 30.0 k Ω

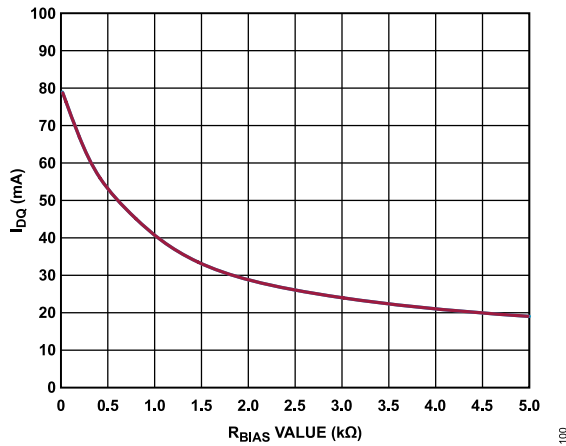

Figure 100. I_{DQ} vs R_{BIAS} , $V_{DD} = 3 V$, R_{BIAS} Range = 0 Ω to 5.0 k Ω

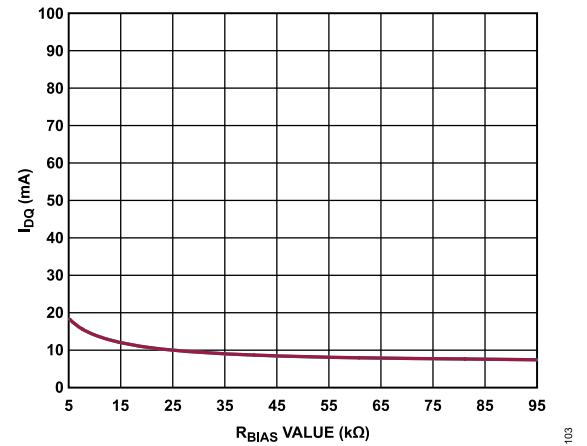

Figure 103. I_{DQ} vs. R_{BIAS} , $V_{DD} = 3 V$, R_{BIAS} Range = 5.0 Ω to 95.0 k Ω

TYPICAL PERFORMANCE CHARACTERISTICS

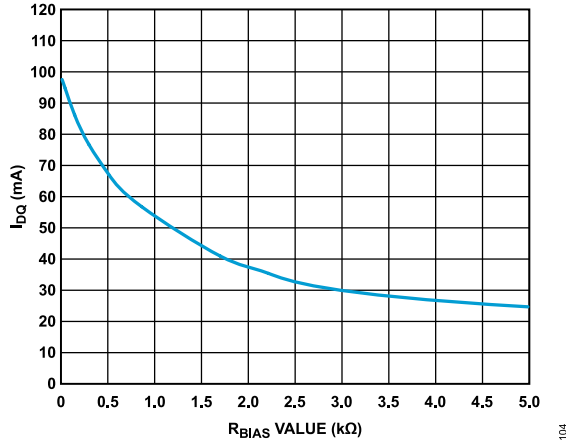

Figure 104. I_{DQ} vs. R_{BIAS} , $V_{DD} = 4\text{ V}$, R_{BIAS} Range = $0\ \Omega$ to $5.0\text{ k}\Omega$

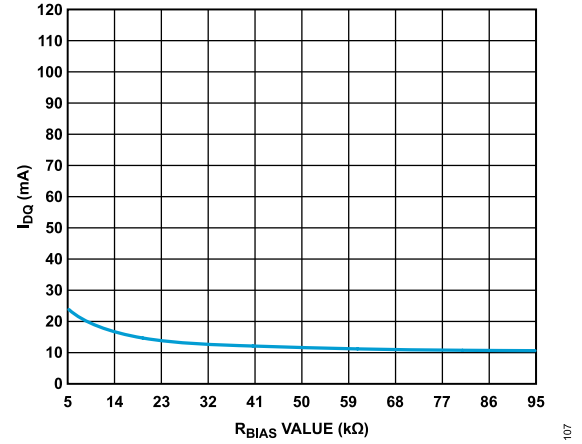

Figure 107. I_{DQ} vs. R_{BIAS} , $V_{DD} = 4\text{ V}$, R_{BIAS} Range = $5.0\text{ k}\Omega$ to $95.0\text{ k}\Omega$

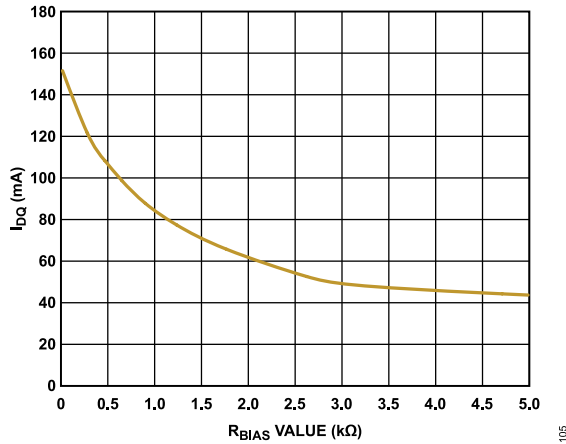

Figure 105. I_{DQ} vs. R_{BIAS} , $V_{DD} = 6\text{ V}$, R_{BIAS} Range = $0\ \Omega$ to $5.0\text{ k}\Omega$

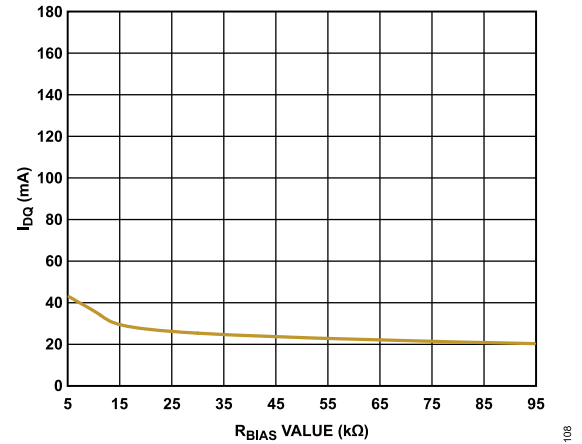

Figure 108. I_{DQ} vs. R_{BIAS} , $V_{DD} = 6\text{ V}$, R_{BIAS} Range = $5.0\ \Omega$ to $95.0\text{ k}\Omega$

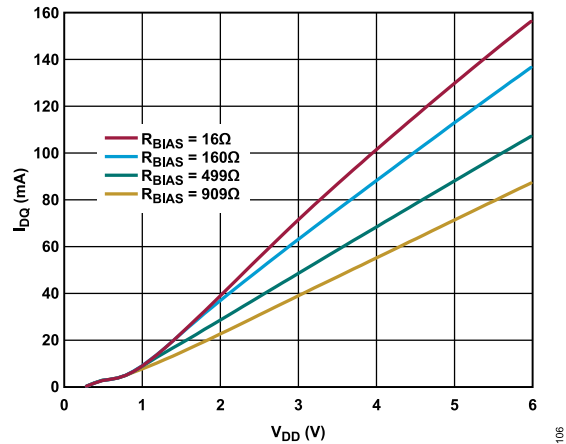

Figure 106. I_{DQ} vs. V_{DD} for Various R_{BIAS} Values

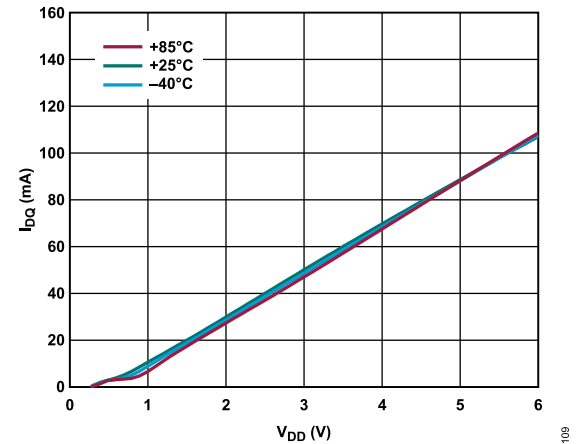

Figure 109. I_{DQ} vs. V_{DD} for Various Temperatures, $R_{BIAS} = 499\ \Omega$

TYPICAL PERFORMANCE CHARACTERISTICS

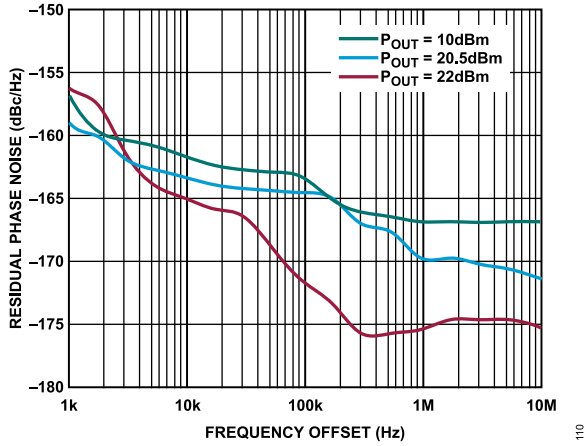

Figure 110. Residual Phase Noise vs. Frequency Offset at 2 GHz for Various P_{OUT} Values

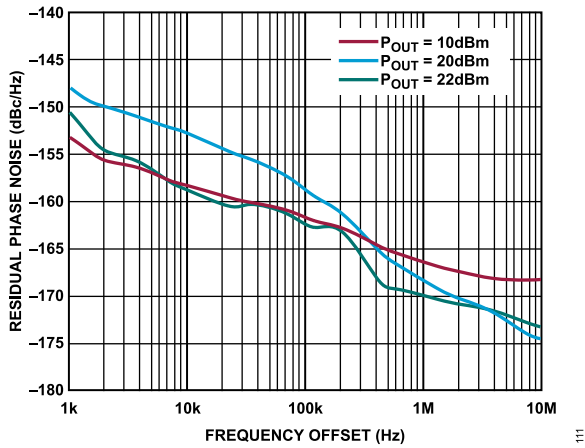

Figure 111. Residual Phase Noise vs. Frequency Offset at 5 GHz for Various P_{OUT} Values

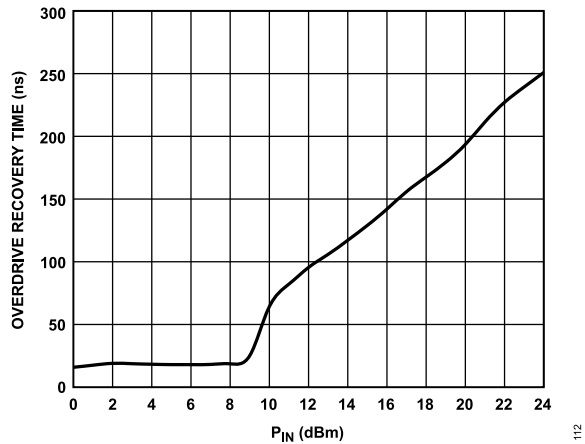

Figure 112. Overdrive Recovery Time vs. P_{IN} at 7.6 GHz, Recovery to Within 90% of Small Signal Gain Value (Blocking Signal at 6 GHz), $V_{DD} = 5\text{ V}$, $R_{BIAS} = 499\ \Omega$

TYPICAL PERFORMANCE CHARACTERISTICS

INTERNAL BYPASS SWITCH STATE

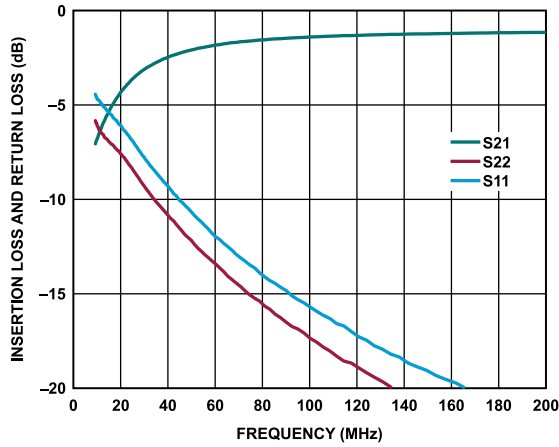

Figure 113. Insertion Loss and Return Loss vs. Frequency, 10 MHz to 200 MHz, $V_{DD} = 5\text{ V}$

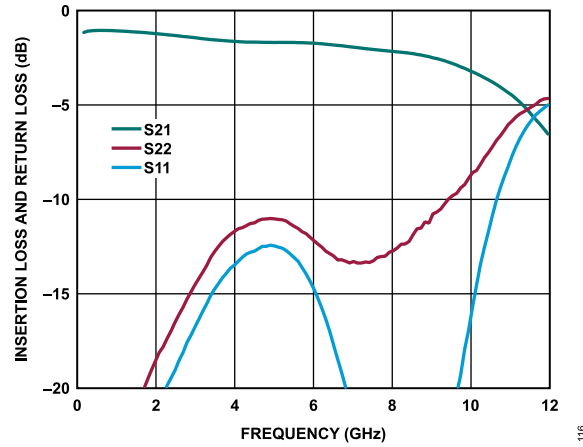

Figure 116. Insertion Loss and Return Loss vs. Frequency, 200 MHz to 12 GHz, $V_{DD} = 5\text{ V}$

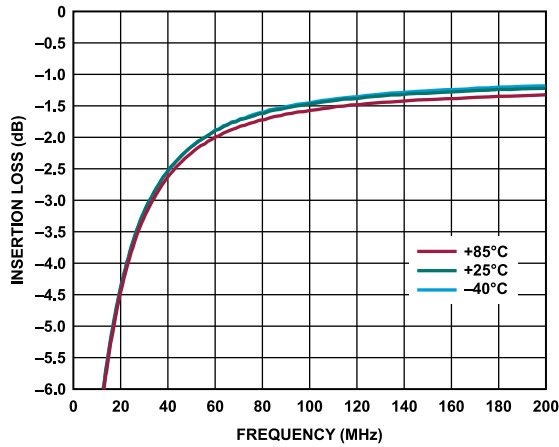

Figure 114. Insertion Loss vs. Frequency for Various Temperatures, 10 MHz to 200 MHz, $V_{DD} = 5\text{ V}$

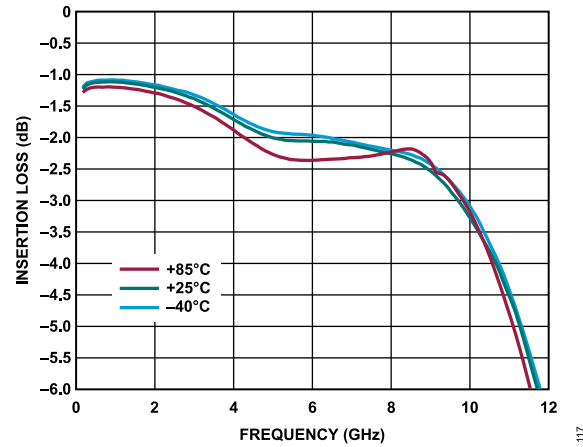

Figure 117. Insertion Loss vs. Frequency for Various Temperatures, 200 MHz to 12 GHz, $V_{DD} = 5\text{ V}$

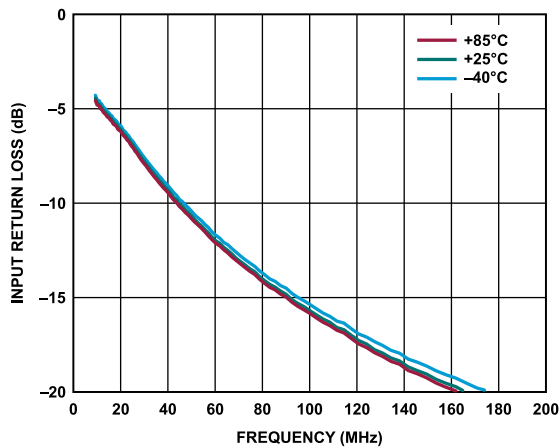

Figure 115. Input Return Loss vs. Frequency for Various Temperatures, 10 MHz to 200 MHz, $V_{DD} = 5\text{ V}$

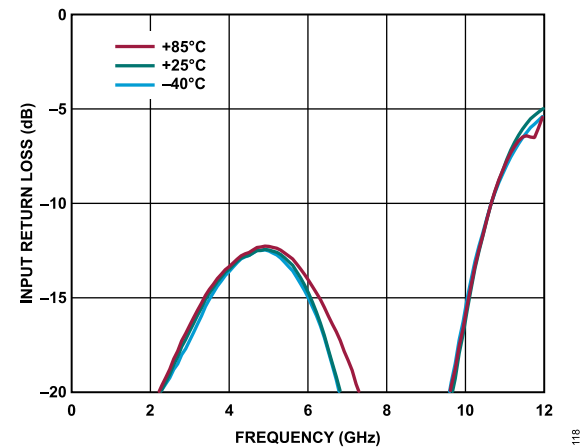

Figure 118. Input Return Loss vs. Frequency for Various Temperatures, 200 MHz to 12 GHz, $V_{DD} = 5\text{ V}$

TYPICAL PERFORMANCE CHARACTERISTICS

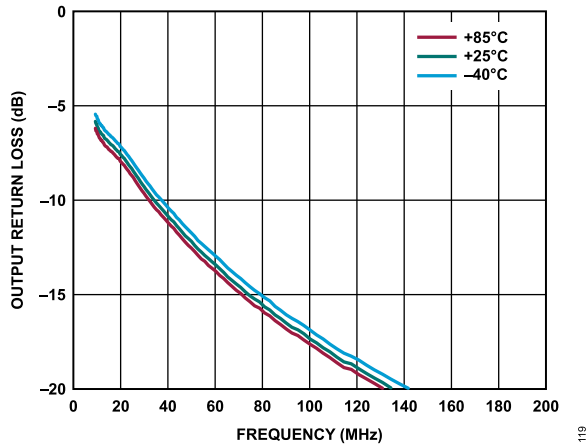

Figure 119. Output Return Loss vs. Frequency for Various Temperatures, 10 MHz to 200 MHz, $V_{DD} = 5\text{ V}$

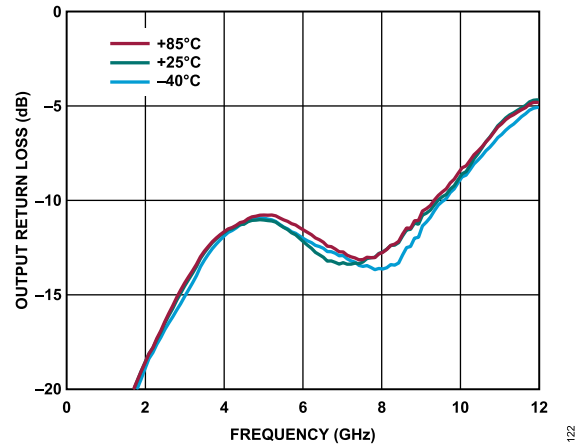

Figure 122. Output Return Loss vs. Frequency for Various Temperatures, 200 MHz to 12 GHz, $V_{DD} = 5\text{ V}$

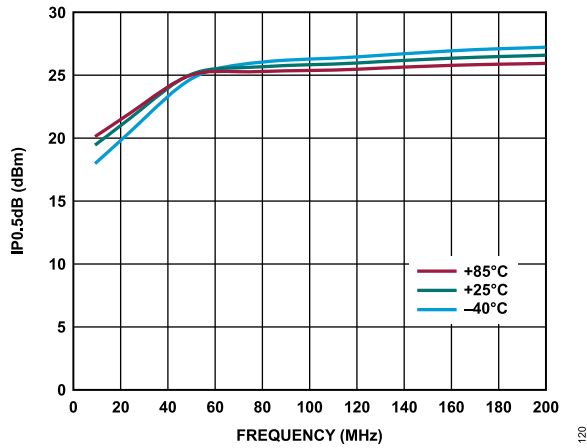

Figure 120. $IP_{0.5dB}$ vs. Frequency for Various Temperatures, 10 MHz to 200 MHz, $V_{DD} = 5\text{ V}$

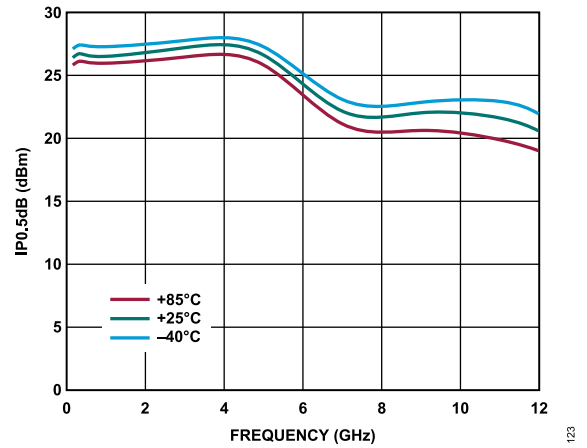

Figure 123. $IP_{0.5dB}$ vs. Frequency for Various Temperatures, 200 MHz to 12 GHz, $V_{DD} = 5\text{ V}$

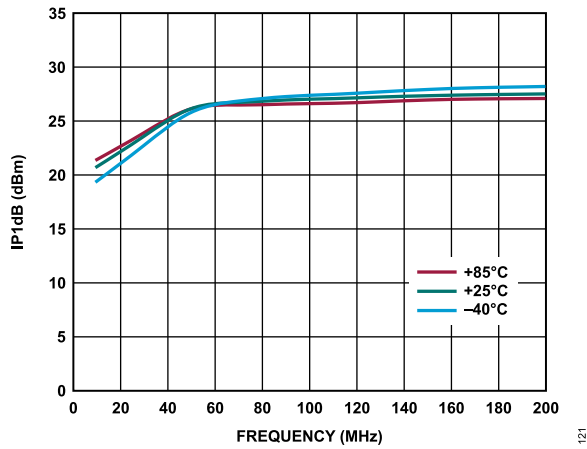

Figure 121. IP_{1dB} vs. Frequency for Various Temperatures, 10 MHz to 200 MHz, $V_{DD} = 5\text{ V}$

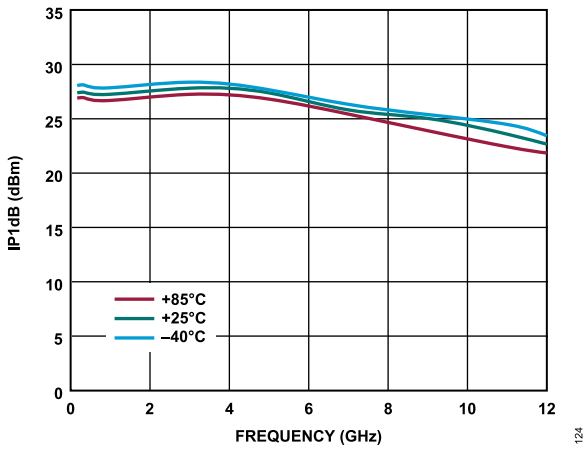

Figure 124. IP_{1dB} vs. Frequency for Various Temperatures, 200 MHz to 12 GHz, $V_{DD} = 5\text{ V}$

TYPICAL PERFORMANCE CHARACTERISTICS

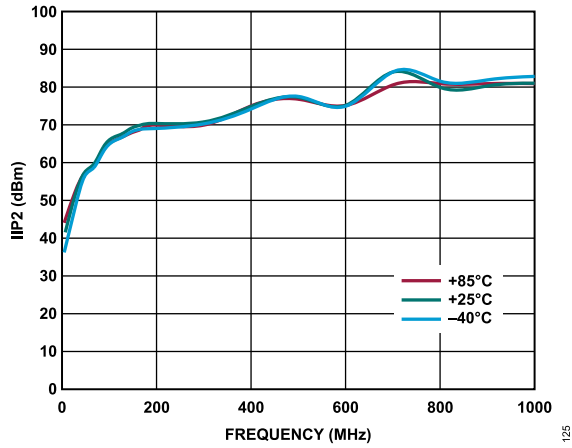

Figure 125. IIP2 vs. Frequency for Various Temperatures, 10 MHz to 1 GHz, $V_{DD} = 5\text{ V}$

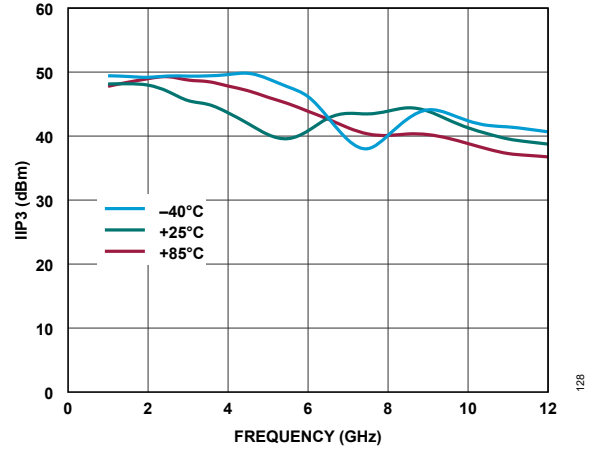

Figure 128. IIP3 vs. Frequency for Various Temperatures, 1 GHz to 12 GHz, $V_{DD} = 5\text{ V}$

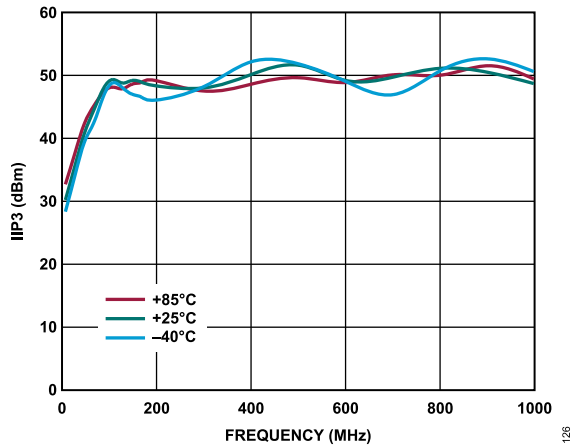

Figure 126. IIP3 vs. Frequency for Various Temperatures, 10 MHz to 1 GHz, $V_{DD} = 5\text{ V}$

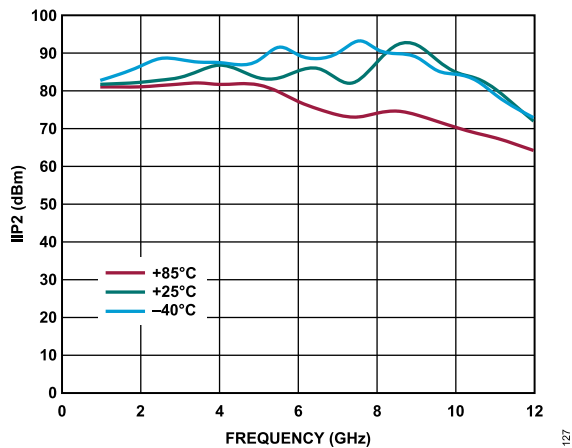

Figure 127. IIP2 vs. Frequency for Various Temperatures, 1 GHz to 12 GHz, $V_{DD} = 5\text{ V}$

THEORY OF OPERATION

The HMC8414 is a low noise wideband amplifier with an integrated bypass switch. [Figure 129](#) shows a simplified schematic. The HMC8414 has DC-coupled, single-ended input and output ports with impedances that are nominally equal to $50\ \Omega$ over the 100 MHz to 10 GHz frequency range. No external matching components are required. To set the I_{DQ} bias current, connect an external resistor between the RBIAS and VDD pins (RFOUT/VDD1 and VDD2).

A logic-low signal on the VCTRL pin enables the amplifier bypass mode. This logic-low signal reduces the supply current to 3 mA.

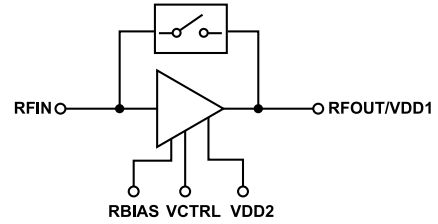

Figure 129. Simplified Schematic

128

APPLICATIONS INFORMATION

The basic connections for operating the HMC8414 are shown in Figure 130. AC-couple the RF input with an appropriately sized capacitor to provide a DC block. The shunt resistor, inductor, and capacitor (RLC) network on the input of the HMC8414 adds resistive loss to help stabilize the amplifier by reducing the gain at low frequencies.

A 3 V to 6 V DC bias is supplied to the amplifier output through a choke inductor connected to the RFOUT/VDD1 pin (Pin 11). A DC block capacitor is required after the bias inductor. Some additional current flows into the VDD2 pin, which must be connected directly to the supply voltage as shown in Figure 130 (most of the bias current flows into the RFOUT/VDD1 pin).

The quiescent drain bias current is set by connecting a resistor between the RBIAS pin and the supply voltage as shown in Figure 130. A 499 Ω resistor is recommended to set the bias current to 90 mA with a 5 V supply.

A logic signal on the VCTRL pin (3 V or 0 V) toggles between amplifier mode and bypass mode with a Logic 1 selecting amplifier mode.

Table 10. Truth Table

Parameter	V _{CTRL}
Amplifier Mode	High
Bypass Mode	Low

Use the following recommended bias sequence during power-up to ensure the amplifier is not damaged:

1. Set V_{DD1} and V_{DD2} to 5 V.
2. Set V_{CTRL} to either 3 V or 0 V to toggle between the amplifier path and bypass path.
3. Apply the RF signal.

The recommended bias sequence during power-down is as follows:

1. Turn off the RF signal.
2. Decrease V_{DD1}, V_{DD2}, and V_{CTRL} to 0 V.

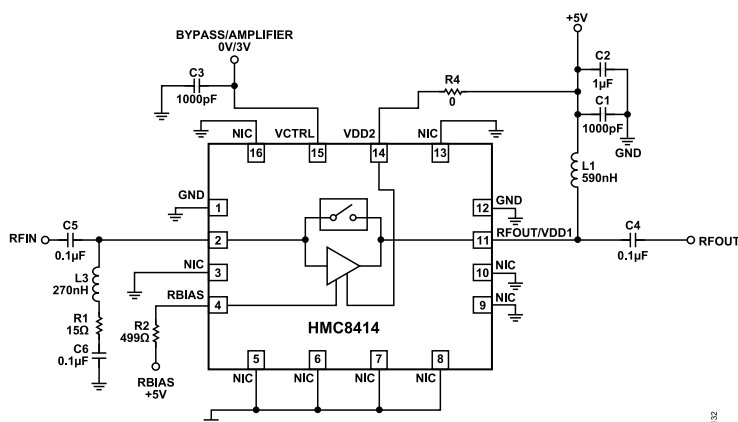

Figure 130. Basic Connections

AMPLIFIER BYPASS MODE RESPONSE

Figure 131 shows the response time of the HMC8414 switching between amplifier mode and bypass mode. The red trace is the V_{CTRL} signal and the blue trace is the output envelope when the input frequency is -10 dBm continuous wave at 250 MHz. This measurement was made using the default application circuit. The settling time of the circuit is strongly influenced by the 590 nH bias inductor (L1 in Figure 130). Reducing the value of this inductor to 77 nH reduces the settling time along with the magnitude of the switching transients (see Figure 132). Reducing the size of the bias inductor also affects the low end frequency response of the circuit.

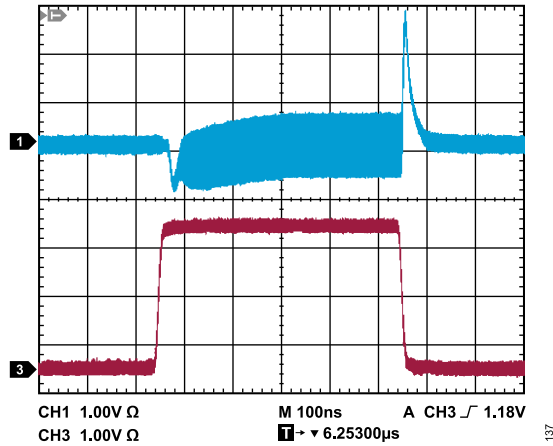

Figure 131. Amplifier Internal Bypass Switch Response Time

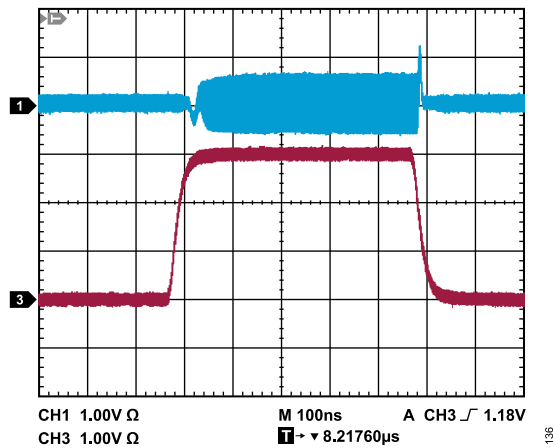

Figure 132. Amplifier Internal Bypass Switch Response Time with Bias Inductor Reduced to 77 nH

RECOMMENDED POWER MANAGEMENT CIRCUIT

Figure 133 shows a recommended power management circuit for the HMC8414. The LT8607 step-down regulator is used to step down a 12 V rail to 6.5 V, which is then applied to the LT3042 low dropout (LDO) linear regulator to generate a low noise 5 V output. Although the circuit shown in Figure 133 has an input voltage of 12 V, the input range to the LT8607 can be as high as 42 V.

The 6.5 V regulator output of the LT8607 is set by the R2 resistor and R3 resistor according to the following equation:

$$R2 = R3[(VOUT/0.778 \text{ V}) - 1] \quad (1)$$

The switching frequency is set to 2 MHz by the 18.2 kΩ resistor on the R_T pin. The LT8607 data sheet provides a table of resistor values that can be used to select other switching frequencies ranging from 0.2 MHz to 2.2 MHz.

The output voltage of the LT3042 is set by the R4 resistor connected to the SET pin according to the following equation:

$$VOUT = 100 \mu\text{A} \times R4 \quad (2)$$

The PGFB resistors are chosen to trigger the power-good (PG) signal when the output is just under 95% of the target voltage of 5 V. The output of the LT3042 has 1% initial tolerance and another

1% variation over temperature. The PGFB resistor tolerance is roughly 3% over temperature, and adding resistors results in a 5% over temperature. Therefore, putting 5% between the output and PGFB resistor works well. In addition, the PG open-collector is pulled up to the 5 V output to supply a convenient 0 V to 5 V voltage range. Table 11 provides the recommended resistor values for operation at 5 V, 3.3 V, and 3 V.

Table 11. Recommended Resistor Values for Operating at 5 V, 3.3 V, and 3 V

LDO Output Voltage (V)	R4 (kΩ)	R7 (kΩ)	R8 (kΩ)
5	49.9	442	30.1
3.3	33.2	287	30.1
3	30.1	255	30.1

The LT8607 can source a maximum current of 750 mA, and the LT3042 can source a maximum current of 200 mA. If the 5 V power supply voltage is being developed as a bus supply to serve another component, higher current devices can be used. The LT8608 and LT8609 step-down regulators can source a maximum current to 1.5 A and 3 A, respectively, and these devices are pin-compatible with the LT8607. The LT3045 linear regulator, which is pin-compatible with the LT3042, can source a maximum current of up to 500 mA.

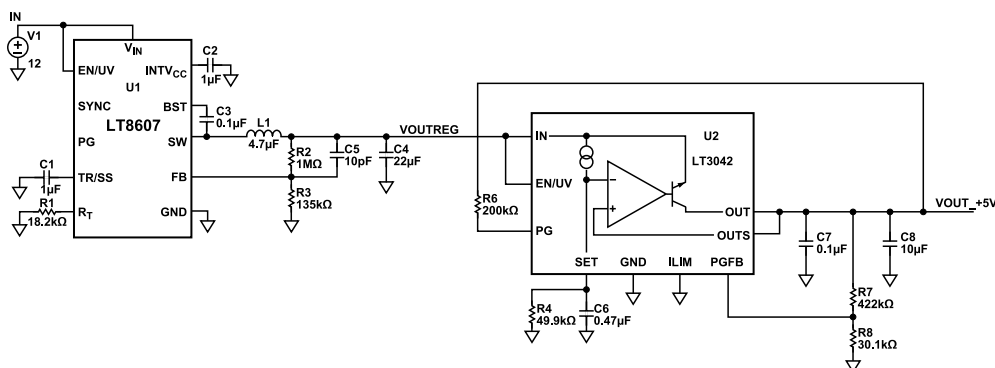

Figure 133. Power Management Circuit

USING THE RBIAS PIN TO ENABLE AND DISABLE THE HMC8414

By attaching a single-pole, double throw (SPDT) switch to the RBIAS pin, an enable and/or disable circuit can be implemented as shown in Figure 135. The ADG719 CMOS switch is used to connect the RBIAS resistor either to supply or ground. When the RBIAS resistor is connected to ground, the overall current consumption reduces to 4.73 mA with no RF signal present and 4.92 mA when the RF input level is -10 dBm. The RF envelope response (blue trace) is driven by the trigger (enable) signal (red trace). Figure 134 shows a plot of the turn-on and/or turn-off response time of the RF output envelope when the IN pin of the ADG719 is pulsed.

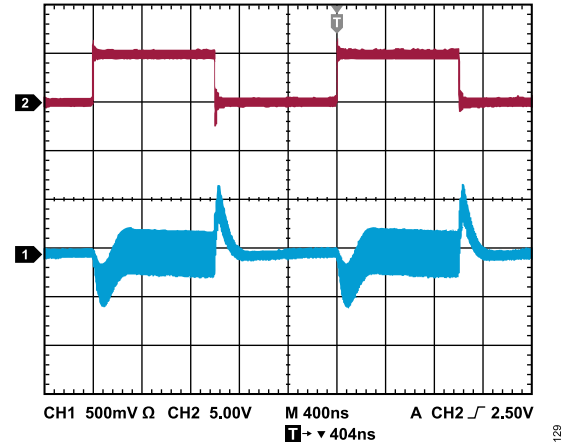

Figure 134. On and/or Off Response of the RF Output Envelope When the IN Pin of the ADG719 Is Pulsed

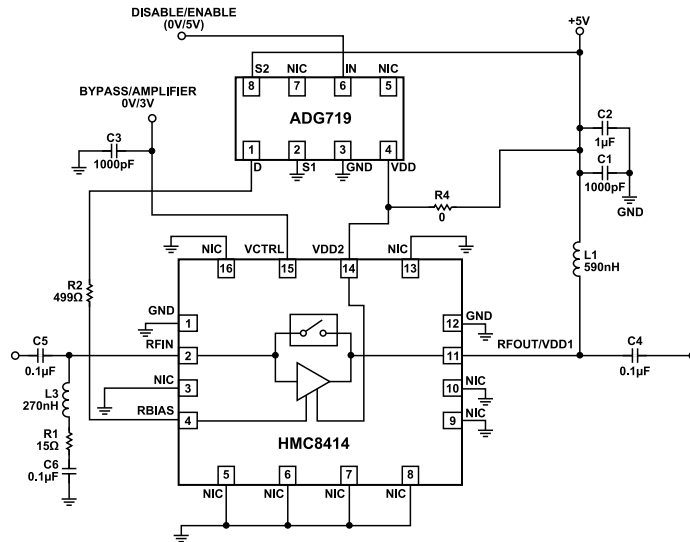
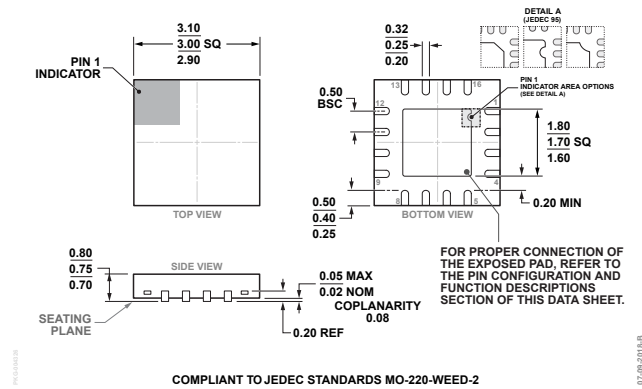

Figure 135. Fast Enable and/or Disable Circuit Using an SPDT

OUTLINE DIMENSIONS



**Figure 136. 16-Lead Lead Frame Chip Scale Package [LFCSP]
3 mm × 3 mm Body and 0.75 Package Height
(CP-16-35)
Dimensions shown in millimeters**

Updated: December 08, 2023

ORDERING GUIDE

Model ¹	Temperature Range	Package Description	Packing Quantity	Package Option
HMC8414ACPZN	-40°C to +85°C	16-Lead LFCSP (3mm x 3mm w/ EP)	Reel, 500	CP-16-35
HMC8414ACPZN-R7	-40°C to +85°C	16-Lead LFCSP (3mm x 3mm w/ EP)	Reel, 500	CP-16-35

¹ Z = RoHS Compliant Part.

EVALUATION BOARDS

Model ¹	Package Description
HMC8414-EVALZ	Evaluation Board

¹ Z = RoHS Compliant Part.