

GaAs MMIC HIGH ISOLATION SPDT SWITCH, DC - 15 GHz

Typical Applications

The HMC607 is ideal for:

- Telecom Infrastructure
- Microwave Radio & VSAT
- Military Radios, Radar & ECM
- Space Systems
- Test Instrumentation

Features

- High Isolation: >50 dB @ 10 GHz
- Low Insertion Loss: 1.4 dB Typical @ 6.0 GHz
- Non-Reflective Design
- Die Size: 2.05 x 1.1 x 0.1 mm

Functional Diagram

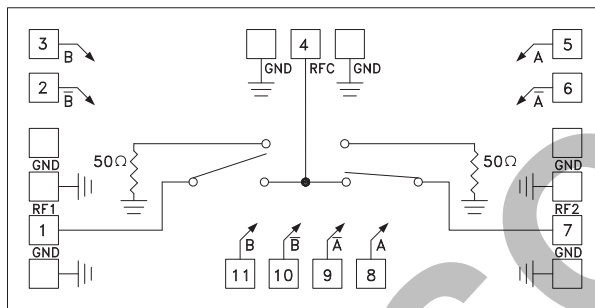

General Description

The HMC607 is a broadband high isolation non-reflective GaAs MESFET SPDT MMIC chip. Covering DC to 15 GHz, the switch features >55 dB isolation at lower frequencies and >45 dB at higher frequencies. The switch operates using complementary negative control voltage logic lines of -5/0V and requires no bias supply.

Electrical Specifications, $T_A = +25^\circ \text{C}$, With 0/-5V Control, 50 Ohm System

Parameter	Frequency	Min.	Typ.	Max.	Units
Insertion Loss	DC - 6 GHz		1.4	1.7	dB
	DC - 10 GHz		1.7	2.5	dB
	DC - 15 GHz		2.7	3.4	dB
Isolation*	DC - 6 GHz	55	65		dB
	DC - 10 GHz	50	60		dB
	DC - 15 GHz	45	55		dB
Return Loss	DC - 6 GHz		17		dB
	DC - 15 GHz		11		dB
Return Loss RF1, RF2	DC - 6 GHz		13		dB
	DC - 15 GHz		17		dB
Input Power for 1 dB Compression	0.5 - 15 GHz	21	26		dBm
Input Third Order Intercept (Two-Tone Input Power= +7 dBm Each Tone, 1 MHz Tone Separation)	0.5 - 15 GHz	44	49		dBm
Switching Characteristics tRISE, tFALL (10/90% RF) tON, tOFF (50% CTL to 10/90% RF)	DC - 15 GHz		3		ns
			5		ns

*Isolation data taken with probe on the die

GaAs MMIC HIGH ISOLATION SPDT SWITCH, DC - 15 GHz

Insertion Loss

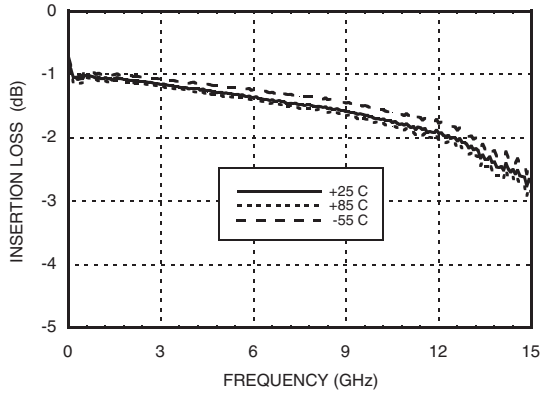

Isolation*

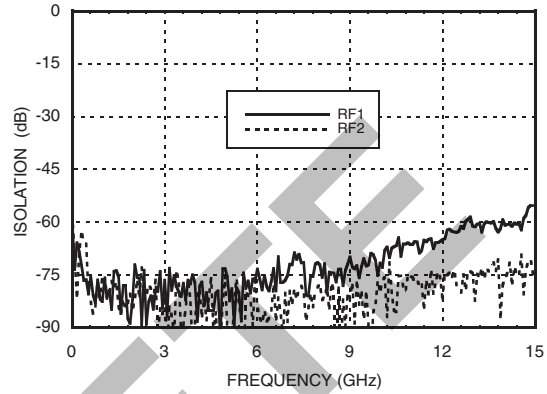

Return Loss

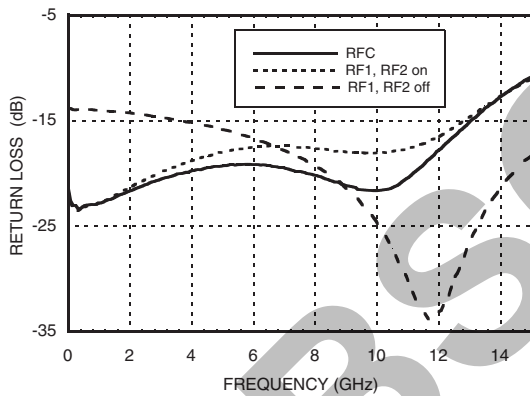

0.1 and 1 dB Input Compression Point

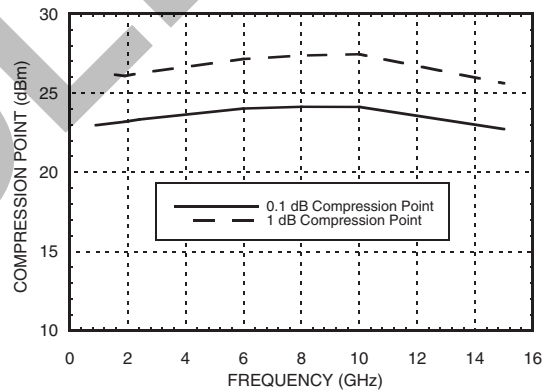

Input Third Order Intercept Point

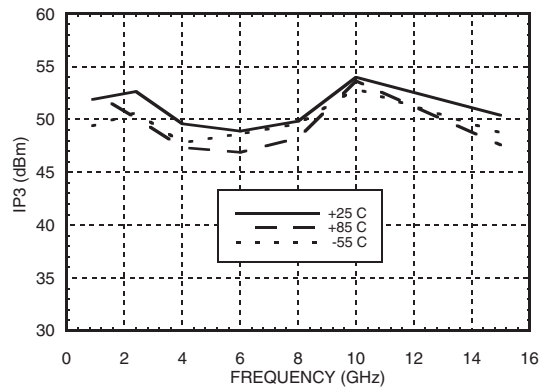

*Isolation data taken with probe on the die

Information furnished by Analog Devices is believed to be accurate and reliable. However, no responsibility is assumed by Analog Devices for its use, nor for any infringements of patents or other rights of third parties that may result from its use. Specifications subject to change without notice. No license is granted by implication or otherwise under any patent or patent rights of Analog Devices. Trademarks and registered trademarks are the property of their respective owners.

For price, delivery, and to place orders: Analog Devices, Inc., One Technology Way, P.O. Box 9106, Norwood, MA 02062-9106 Phone: 781-329-4700 • Order online at www.analog.com Application Support: Phone: 1-800-ANALOG-D

GaAs MMIC HIGH ISOLATION SPDT SWITCH, DC - 15 GHz

Absolute Maximum Ratings

RF Input Power (A, \bar{A} , B, \bar{B} = 0/-5V) (0.5 - 6 GHz)	+30 dBm (@ +50 °C)
Control Voltage Range (A, \bar{A} , B, \bar{B})	+1V to -7.5 Vdc
Channel Temperature	150 °C
Thermal Resistance (R_{TH}) (junction to lead)	94 °C/W
Storage Temperature	-65 to +150 °C
Operating Temperature	-55 to +85 °C

Control Voltages

State	Bias Condition
Low	0 to -0.2V @ 10 uA Max.
High	-5V @ 10 uA Typ. to -7V @ 45 uA Typ.



**ELECTROSTATIC SENSITIVE DEVICE
OBSERVE HANDLING PRECAUTIONS**

Truth Table

Control Input				Signal Path State	
B	\bar{B}	\bar{A}	A	RFC to RF1	RFC to RF2
Low	High	Low	High	ON	OFF
High	Low	High	Low	OFF	ON
High	Low	Low	High	OFF	OFF
Low	High	High	Low	ON	ON

Caution: Do not "Hot Switch" power levels greater than +27 dBm (A, \bar{A} , B, \bar{B} = 0/-5V).

Suggested Driver Circuit for Single Line Control

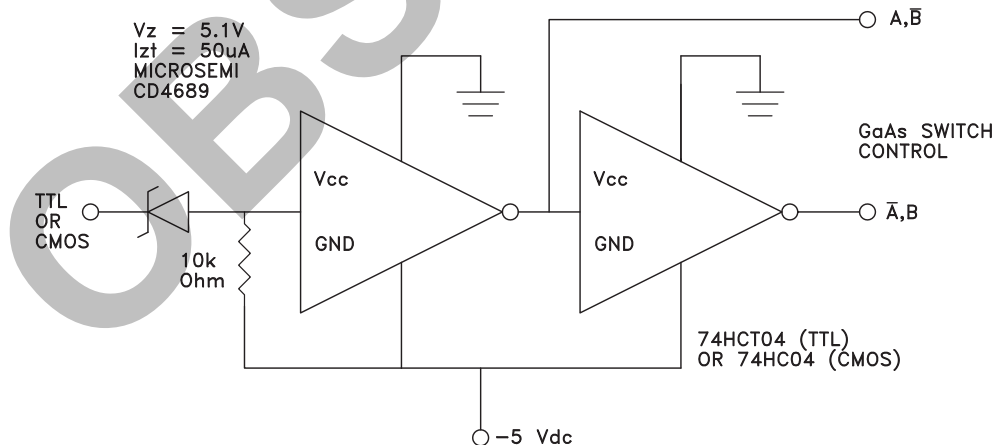

Information furnished by Analog Devices is believed to be accurate and reliable. However, no responsibility is assumed by Analog Devices for its use, nor for any infringements of patents or other rights of third parties that may result from its use. Specifications subject to change without notice. No license is granted by implication or otherwise under any patent or patent rights of Analog Devices. Trademarks and registered trademarks are the property of their respective owners.

For price, delivery, and to place orders: Analog Devices, Inc., One Technology Way, P.O. Box 9106, Norwood, MA 02062-9106
Phone: 781-329-4700 • Order online at www.analog.com
Application Support: Phone: 1-800-ANALOG-D

GaAs MMIC HIGH ISOLATION SPDT SWITCH, DC - 15 GHz

Outline Drawing

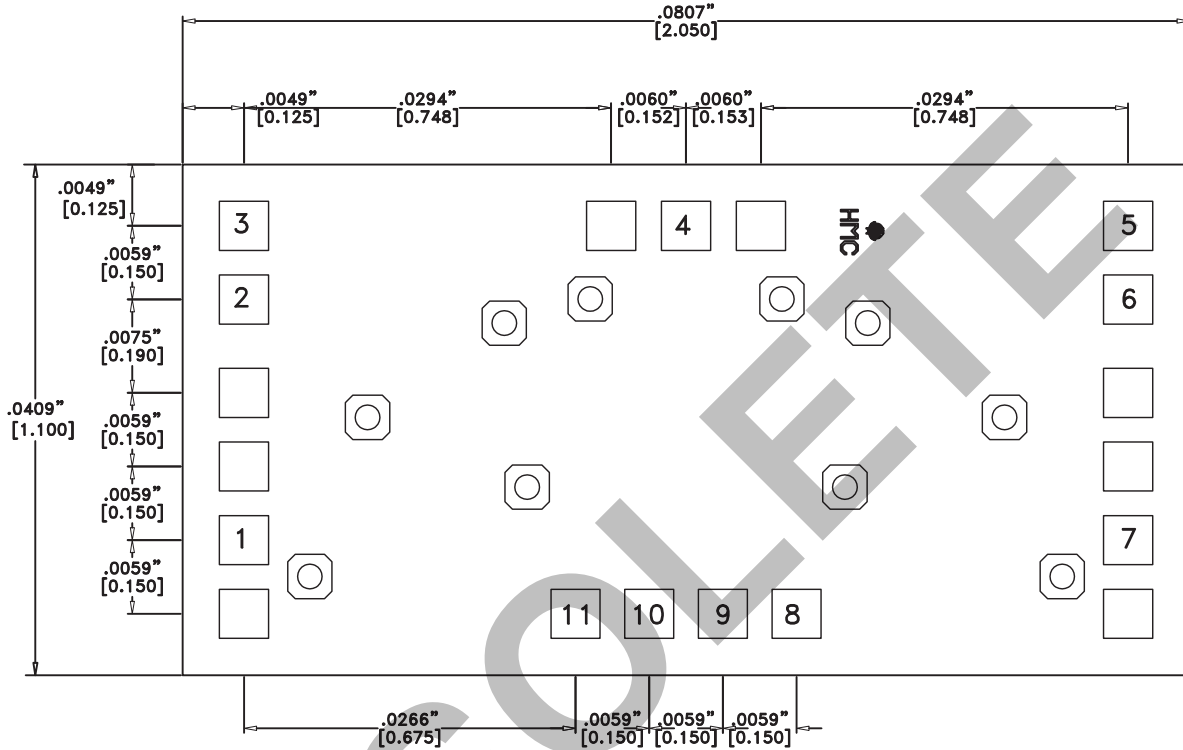

Die Packaging Information [1]

Standard	Alternate
WP-17 (Waffle Pack)	[2]

[1] Refer to the "Packaging Information" section for die packaging dimensions.

[2] For alternate packaging information contact Hittite Microwave Corporation.

NOTES:

1. ALL DIMENSIONS ARE IN INCHES [MM]
2. DIE THICKNESS IS .004"
3. TYPICAL BOND PAD IS .004" SQUARE
4. BACKSIDE METALIZATION: GOLD
5. BACKSIDE METAL IS GROUND
6. BOND PAD METALIZATION: GOLD
7. NO CONNECTION REQUIRED FOR UNLABELED BOND PADS.
8. OVERALL DIE SIZE ±.002"

Pad Descriptions

Pad Number	Function	Description	Interface Schematic
1, 4, 7	RF1, RFC, RF2	This pin is DC coupled and matched to 50 Ohm. Blocking capacitors are required if RF line potential is not equal to 0V.	
2, 10	\bar{B}	See truth table and control voltage table. Alternate A & B control pads provided.	
3, 11	B		
5, 8	A		
6, 9	\bar{A}		
Die Bottom	GND	Die bottom must be connected to RF ground.	

Information furnished by Analog Devices is believed to be accurate and reliable. However, no responsibility is assumed by Analog Devices for its use, nor for any infringements of patents or other rights of third parties that may result from its use. Specifications subject to change without notice. No license is granted by implication or otherwise under any patent or patent rights of Analog Devices. Trademarks and registered trademarks are the property of their respective owners.

For price, delivery, and to place orders: Analog Devices, Inc., One Technology Way, P.O. Box 9106, Norwood, MA 02062-9106
Phone: 781-329-4700 • Order online at www.analog.com
Application Support: Phone: 1-800-ANALOG-D

**GaAs MMIC HIGH ISOLATION
SPDT SWITCH, DC - 15 GHz**

Assembly Diagram

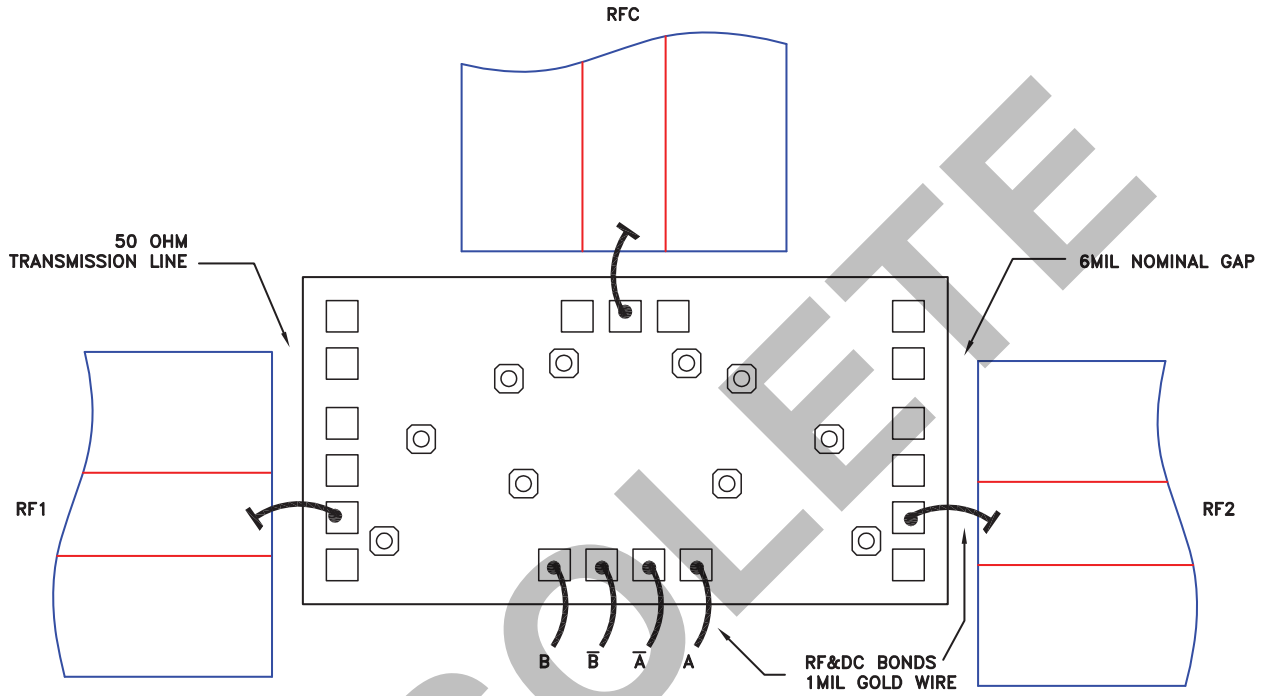

GaAs MMIC HIGH ISOLATION SPDT SWITCH, DC - 15 GHz

Mounting & Bonding Techniques for Millimeterwave GaAs MMICs

The die should be attached directly to the ground plane eutectically or with conductive epoxy (see HMC general Handling, Mounting, Bonding Note).

50 Ohm Microstrip transmission lines on 0.127mm (5 mil) thick alumina thin film substrates are recommended for bringing RF to and from the chip (Figure 1). If 0.254mm (10 mil) thick alumina thin film substrates must be used, the die should be raised 0.150mm (6 mils) so that the surface of the die is coplanar with the surface of the substrate. One way to accomplish this is to attach the 0.102mm (4 mil) thick die to a 0.150mm (6 mil) thick molybdenum heat spreader (moly-tab) which is then attached to the ground plane (Figure 2).

Microstrip substrates should be brought as close to the die as possible in order to minimize bond wire length. Typical die-to-substrate spacing is 0.076mm (3 mils).

Handling Precautions

Follow these precautions to avoid permanent damage.

Storage: All bare die are placed in either Waffle or Gel based ESD protective containers, and then sealed in an ESD protective bag for shipment. Once the sealed ESD protective bag has been opened, all die should be stored in a dry nitrogen environment.

Cleanliness: Handle the chips in a clean environment. DO NOT attempt to clean the chip using liquid cleaning systems.

Static Sensitivity: Follow ESD precautions to protect against ESD strikes.

Transients: Suppress instrument and bias supply transients while bias is applied. Use shielded signal and bias cables to minimize inductive pick-up.

General Handling: Handle the chip along the edges with a vacuum collet or with a sharp pair of bent tweezers. The surface of the chip has fragile air bridges and should not be touched with vacuum collet, tweezers, or fingers.

Mounting

The chip is back-metallized and can be die mounted with AuSn eutectic preforms or with electrically conductive epoxy. The mounting surface should be clean and flat.

Epoxy Die Attach: Apply a minimum amount of epoxy to the mounting surface so that a thin epoxy fillet is observed around the perimeter of the chip once it is placed into position. Cure epoxy per the manufacturer's schedule.

Wire Bonding

Ball or wedge bond with 0.025 mm (1 mil) diameter pure gold wire (DC bias, IF1 and IF2) or Ribbon Bond (RF and LO ports) 0.076 mm x 0.013 mm (3 mil x 0.5 mil) size is recommended. Thermosonic wirebonding with a nominal stage temperature of 150 °C and a ball bonding force of 40 to 50 grams or wedge bonding force of 18 to 22 grams is recommended. Use the minimum level of ultrasonic energy to achieve reliable wirebonds. Wirebonds should be started on the chip and terminated on the package or substrate. All bonds should be as short as possible <0.31 mm (12 mils).

