

ADV7390/ADV7391/ADV7392/ADV7393

Low Power, Chip Scale, 10-Bit SD/HD Video Encoder

FEATURES

- ▶ 3 high quality, 10-bit video DACs
 - ▶ 16× (216 MHz) DAC oversampling for SD
 - ▶ 8× (216 MHz) DAC oversampling for ED
 - ▶ 4× (297 MHz) DAC oversampling for HD
 - ▶ 37 mA maximum DAC output current
- ▶ Multiformat video input support
 - ▶ 4:2:2 YCrCb (SD, ED, and HD)
 - ▶ 4:4:4 RGB (SD)
- ▶ Multiformat video output support
 - ▶ Composite (CVBS) and S-Video (Y-C)
 - ▶ Component YPrPb (SD, ED, and HD)
 - ▶ Component RGB (SD, ED, and HD)
- ▶ Lead frame chip scale package (LFCSP) options
 - ▶ 32-lead, 5 mm × 5 mm LFCSP
 - ▶ 40-lead, 6 mm × 6 mm LFCSP
- ▶ Wafer level chip scale package (WLCSP) option
 - ▶ 30-ball, 5 × 6 WLCSP with single DAC output
- ▶ Advanced power management
 - ▶ Patented content-dependent low power DAC operation
 - ▶ Automatic cable detection and DAC power-down
 - ▶ Individual DAC on/off control
 - ▶ Sleep mode with minimal power consumption
- ▶ 74.25 MHz 8-/10-/16-bit high definition input support
 - ▶ Compliant with SMPTE 274M (1080i), 296M (720p), and 240M (1035i)
- ▶ EIA/CEA-861B compliance support
- ▶ NTSC M, PAL B/D/G/H/I/M/N, PAL 60 support
- ▶ NTSC and PAL square pixel operation (24.54 MHz/29.5 MHz)
- ▶ Macrovision Rev 7.1.L1 (SD) and Rev 1.2 (ED) compliant
- ▶ Copy generation management system (CGMS)
- ▶ Closed captioning and wide screen signaling (WSS)
- ▶ Integrated subcarrier locking to external video source
- ▶ Complete on-chip video timing generator
- ▶ On-chip test pattern generation
- ▶ Programmable features
 - ▶ Luma and chroma filter responses
 - ▶ Vertical blanking interval (VBI)
 - ▶ Subcarrier frequency (f_{SC}) and phase
 - ▶ Luma delay
- ▶ High definition (HD) programmable features (720p/1080i/1035i)
 - ▶ 4× oversampling (297 MHz)
 - ▶ Internal test pattern generator
 - ▶ Color and black bar, hatch, flat field/frame
- ▶ Fully programmable YCrCb to RGB matrix
- ▶ Gamma correction
- ▶ Programmable adaptive filter control
- ▶ Programmable sharpness filter control
- ▶ CGMS (720p/1080i) and CGMS Type B (720p/1080i)
- ▶ Dual data rate (DDR) input support
- ▶ Enhanced definition (ED) programmable features (525p/625p)
 - ▶ 8× oversampling (216 MHz output)
 - ▶ Internal test pattern generator
 - ▶ Black bar, hatch, flat field/frame
 - ▶ Individual Y and PrPb output delay
 - ▶ Gamma correction
 - ▶ Programmable adaptive filter control
 - ▶ Fully programmable YCrCb to RGB matrix
 - ▶ Undershoot limiter
 - ▶ Macrovision Rev 1.2 (525p/625p) (ADV7390/ADV7392 only)
 - ▶ CGMS (525p/625p) and CGMS Type B (525p)
 - ▶ Dual data rate (DDR) input support
- ▶ Standard definition (SD) programmable features
 - ▶ 16× oversampling (216 MHz)
 - ▶ Internal test pattern generator
 - ▶ Color and black bar
 - ▶ Controlled edge rates for start and end of active video
 - ▶ Individual Y and PrPb output delay
 - ▶ Undershoot limiter
 - ▶ Gamma correction
 - ▶ Digital noise reduction (DNR)
 - ▶ Multiple chroma and luma filters
 - ▶ Luma-SSAF filter with programmable gain/attenuation
 - ▶ PrPb SSAF
 - ▶ Separate pedestal control on component and composite/S-Video output
 - ▶ VCR FF/RW sync mode
 - ▶ Macrovision Rev 7.1.L1 (ADV7390/ADV7392 only)
 - ▶ Copy generation management system (CGMS)
 - ▶ Wide screen signaling (WSS)
 - ▶ Closed captioning
- ▶ Serial MPU interface with I²C compatibility
- ▶ 2.7 V or 3.3 V analog operation
- ▶ 1.8 V digital operation
- ▶ 1.8 V or 3.3 V I/O operation
- ▶ Temperature range: -40°C to +85°C
- ▶ W Grade automotive range: -40°C to +105°C
- ▶ AEC-Q100 qualified for automotive applications

Rev. K

DOCUMENT FEEDBACK

TECHNICAL SUPPORT

Information furnished by Analog Devices is believed to be accurate and reliable "as is". However, no responsibility is assumed by Analog Devices for its use, nor for any infringements of patents or other rights of third parties that may result from its use. Specifications subject to change without notice. No license is granted by implication or otherwise under any patent or patent rights of Analog Devices. Trademarks and registered trademarks are the property of their respective owners.

TABLE OF CONTENTS

Features.....	1	SD Luma and Color Scale Control.....	55
Applications.....	4	SD Hue Adjust Control.....	55
General Description.....	4	SD Brightness Detect.....	55
Functional Block Diagrams.....	5	SD Brightness Control.....	55
Specifications.....	6	SD Input Standard Autodetection.....	56
Power Supply Specifications.....	6	Double Buffering.....	56
Input Clock Specifications.....	6	Programmable DAC Gain Control.....	56
Analog Output Specifications.....	6	Gamma Correction.....	57
Digital Input/Output Specifications—3.3 V.....	7	ED/HD Sharpness Filter and Adaptive Filter Controls.....	58
Digital Input/Output Specifications—1.8 V.....	7	ED/HD Sharpness Filter and Adaptive Filter Application Examples.....	60
MPU Port Timing Specifications.....	7	SD Digital Noise Reduction.....	61
Digital Timing Specifications—3.3 V.....	8	SD Active Video Edge Control.....	62
Digital Timing Specifications—1.8 V.....	9	External Horizontal and Vertical Synchronization Control.....	63
Video Performance Specifications.....	10	Low Power Mode.....	64
Power Specifications.....	10	Cable Detection.....	65
Timing Diagrams.....	11	DAC Autopower-Down.....	65
Absolute Maximum Ratings.....	16	Sleep Mode.....	65
Thermal Resistance.....	16	Pixel and Control Port Readback.....	65
ESD Caution.....	16	Reset Mechanisms.....	65
Pin Configurations and Function Descriptions.....	17	SD Teletext Insertion.....	66
Typical Performance Characteristics.....	19	Printed Circuit Board Layout and Design.....	67
MPU Port Description.....	24	Unused Pins.....	67
I ² C Operation.....	24	DAC Configurations.....	67
Register Map Access.....	26	Video Output Buffer and Optional Output Filter.....	67
Register Programming.....	26	Printed Circuit Board (PCB) Layout.....	68
Subaddress Register (SR7 to SR0).....	26	Additional Layout Considerations for the WLCSP Package.....	69
ADV7390/ADV7391 Input Configuration.....	43	Typical Applications Circuits.....	70
Standard Definition.....	43	Copy Generation Management System.....	72
Enhanced Definition/High Definition.....	43	SD CGMS.....	72
Enhanced Definition (at 54 MHz).....	43	ED CGMS.....	72
ADV7392/ADV7393 Input Configuration.....	44	HD CGMS.....	72
Standard Definition.....	44	CGMS CRC Functionality.....	72
Enhanced Definition/High Definition.....	45	SD Wide Screen Signaling.....	75
Enhanced Definition (at 54 MHz).....	46	Subaddress 0x99, Subaddress 0x9A, Subaddress 0x9B.....	75
Output Configuration.....	47	SD Closed Captioning.....	76
Design Features.....	48	Subaddress 0x91 to Subaddress 0x94.....	76
Output Oversampling.....	48	Internal Test Pattern Generation.....	77
HD Interlace External $\overline{\text{HSYNC}}$ and $\overline{\text{VSYNC}}$ Considerations.....	49	SD Test Patterns.....	77
ED/HD Timing Reset.....	49	ED/HD Test Patterns.....	77
SD Subcarrier Frequency Lock.....	49	SD Timing.....	78
SD VCR FF/RW Sync.....	50	Mode 0 (CCIR-656)—Subordinate Option (Subaddress 0x8A = X X X X X 0 0 0).....	78
Vertical Blanking Interval.....	50		
SD Subcarrier Frequency Control.....	50		
SD Noninterlaced Mode.....	50		
SD Square Pixel Mode.....	51		
Filters.....	52		
ED/HD Test Pattern Color Controls.....	53		
Color Space Conversion Matrix.....	53		

TABLE OF CONTENTS

Mode 0 (CCIR-656)—Main Option (Subaddress 0x8A = X X X X X 0 0 1).....	78	ED/HD YPrPb Output Levels.....	85
Mode 1—Subordinate Option (Subaddress 0x8A = X X X X X 0 1 0).....	79	SD/ED/HD RGB Output Levels.....	86
Mode 1—Main Option (Subaddress 0x8A = X X X X X 0 1 1).....	80	SD Output Plots.....	87
Mode 2—Subordinate Option (Subaddress 0x8A = X X X X X 1 0 0).....	80	Video Standards.....	88
Mode 2—Main Option (Subaddress 0x8A = X X X X X 1 0 1).....	81	Configuration Scripts.....	90
Mode 3—Main/Subordinate Option (Subaddress 0x8A = X X X X X 1 1 0 or X X X X X 1 1 1).....	81	Standard Definition.....	90
HD Timing.....	83	Enhanced Definition.....	96
Video Output Levels.....	84	High Definition.....	98
SD YPrPb Output Levels—SMPTE/EBU N10..	84	ADV7390/ADV7391/ADV7392/ADV7393	
		Evaluation Board.....	100
		Outline Dimensions.....	101
		Ordering Guide.....	101
		Macrovision Antitaping.....	101
		Evaluation Boards.....	102
		Automotive Products.....	102

REVISION HISTORY

11/2024—Rev. J to Rev. K

Changed Master to Main and Slave to Subordinate (Throughout).....	1
Changes to Figure 18 Caption and Figure 19 Caption.....	17
Added Figure 20 and Figure 21; Renumbered Sequentially.....	17
Updated Outline Dimensions.....	101
Changes to Ordering Guide.....	101

APPLICATIONS

- ▶ Mobile handsets
- ▶ Digital still cameras
- ▶ Portable media and DVD players
- ▶ Portable game consoles
- ▶ Digital camcorders
- ▶ Set-top box (STB)
- ▶ Automotive infotainment (ADV7392 and ADV7393 only)

GENERAL DESCRIPTION

The ADV7390/ADV7391/ADV7392/ADV7393 are a family of high speed, digital-to-analog video encoders on single monolithic chips. Three 2.7 V/3.3 V, 10-bit video DACs (a single DAC for the WLCSP package) provide support for composite (CVBS), S-Video (Y-C), or component (YPrPb/RGB) analog outputs in either standard definition (SD) or high definition (HD) video formats. The single DAC WLCSP package supports CVBS (NTSC and PAL) output only in SD resolution (see [Table 2](#)).

Optimized for low power operation, occupying a minimal footprint, and requiring few external components, these encoders are ideally suited to portable and power-sensitive applications requiring TV-out functionality. Cable detection and DAC auto power-down features ensure that power consumption is kept to a minimum.

The ADV7390/ADV7391 have an 8-bit video input port that supports SD video formats over an SDR interface and HD video formats over a DDR interface. The ADV7392/ADV7393 have a 16-bit video input port that can be configured in a variety of ways. SD RGB input is supported.

All members of the family support embedded EAV/SAV timing codes, external video synchronization signals, and the I²C[®] and communication protocol. [Table 1](#) and [Table 2](#) list the video standards directly supported by the ADV7390/ADV7391/ADV7392/ADV7393 family.

Table 1. Standards Directly Supported by the LFCSP Packages

Active Resolution	I/P ¹	Frame Rate (Hz)	Clock Input (MHz)	Standard
720 × 240	P	59.94	27	
720 × 288	P	50	27	
720 × 480	I	29.97	27	ITU-R BT.601/656
720 × 576	I	25	27	ITU-R BT.601/656
640 × 480	I	29.97	24.54	NTSC square pixel
768 × 576	I	25	29.5	PAL square pixel
720 × 483	P	59.94	27	SMPTE 293M
720 × 483	P	59.94	27	BTA T-1004
720 × 483	P	59.94	27	ITU-R BT.1358
720 × 576	P	50	27	ITU-R BT.1358
720 × 483	P	59.94	27	ITU-R BT.1362
720 × 576	P	50	27	ITU-R BT.1362
1920 × 1035	I	30	74.25	SMPTE 240M
1920 × 1035	I	29.97	74.1758	SMPTE 240M

Table 1. Standards Directly Supported by the LFCSP Packages (Continued)

Active Resolution	I/P ¹	Frame Rate (Hz)	Clock Input (MHz)	Standard
1280 × 720	P	60, 50, 30, 25, 24	74.25	SMPTE 296M
1280 × 720	P	23.97, 59.94, 29.97	74.1758	SMPTE 296M
1920 × 1080	I	30, 25	74.25	SMPTE 274M
1920 × 1080	I	29.97	74.1758	SMPTE 274M
1920 × 1080	P	30, 25, 24	74.25	SMPTE 274M
1920 × 1080	P	23.98, 29.97	74.1758	SMPTE 274M
1920 × 1080	P	24	74.25	ITU-R BT.709-5

¹ I = interlaced, P = progressive.

Table 2. Standards Directly Supported by the WLCSP Package

Active Resolution	I/P ¹	Frame Rate (Hz)	Clock Input (MHz)	Standard
720 × 480	I	29.97	27	ITU-R BT.601/656
720 × 576	I	25	27	ITU-R BT.601/656
640 × 480	I	29.97	24.54	NTSC Square Pixel
768 × 576	I	25	29.5	PAL Square Pixel

¹ I = interlaced, P = progressive.

FUNCTIONAL BLOCK DIAGRAMS

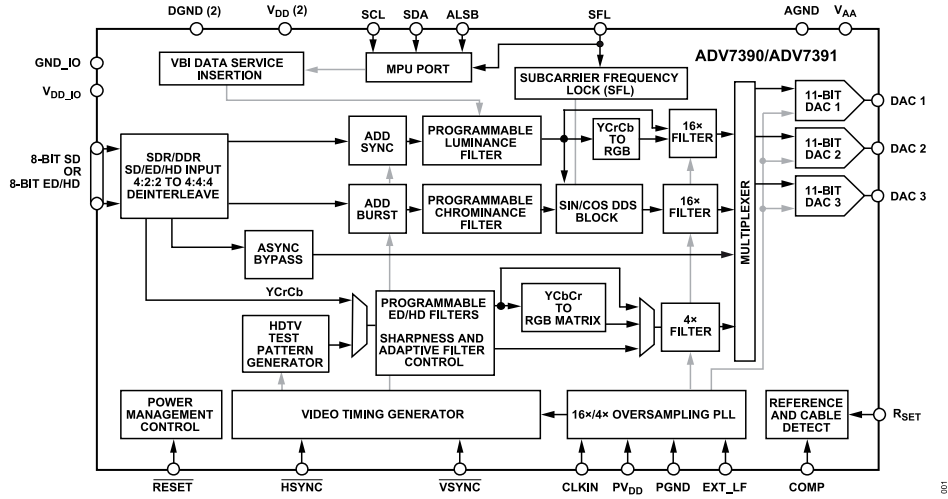

Figure 1. ADV7390/ADV7391 (32-Lead LFCSP)

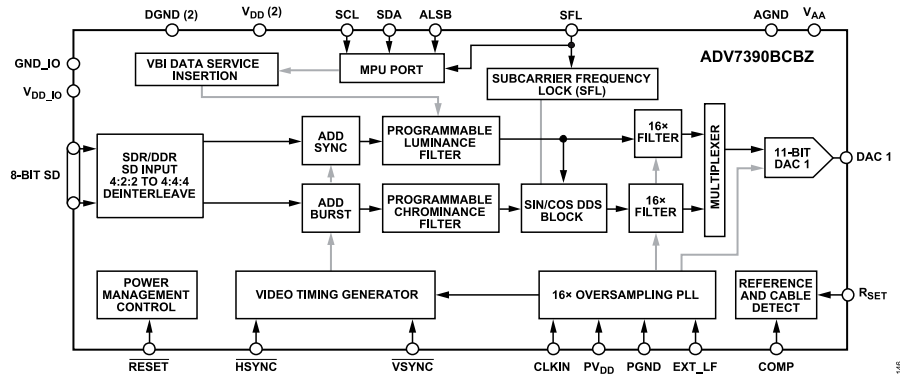

Figure 2. ADV7390BCBZ-A (30-Ball WLCSP)

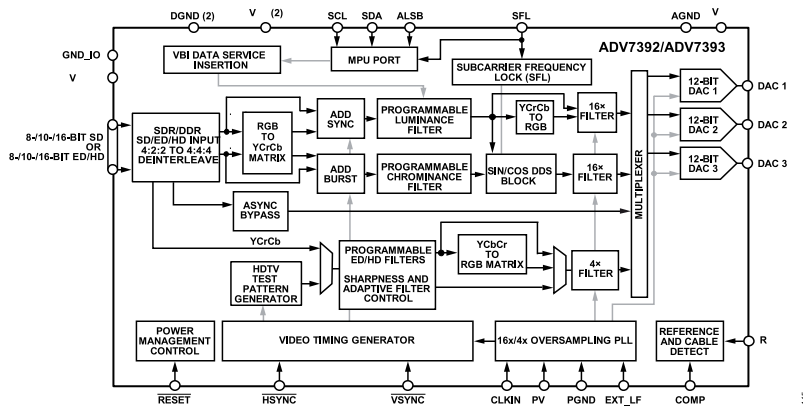

Figure 3. ADV7392/ADV7393 (40-Lead LFCSP)

SPECIFICATIONS

POWER SUPPLY SPECIFICATIONS

All specifications T_{MIN} to T_{MAX} (-40°C to $+85^{\circ}\text{C}$), unless otherwise noted.

Table 3.

Parameter	Min	Typ	Max	Unit
SUPPLY VOLTAGES				
V_{DD}	1.71	1.8	1.89	V
V_{DD_IO}	1.71	3.3	3.63	V
PV_{DD}	1.71	1.8	1.89	V
V_{AA}	2.6	3.3	3.465	V
POWER SUPPLY REJECTION RATIO		0.002		%/%

INPUT CLOCK SPECIFICATIONS

$V_{DD} = 1.71\text{ V to }1.89\text{ V}$, $PV_{DD} = 1.71\text{ V to }1.89\text{ V}$, $V_{AA} = 2.6\text{ V to }3.465\text{ V}$, $V_{DD_IO} = 1.71\text{ V to }3.63\text{ V}$. All specifications T_{MIN} to T_{MAX} (-40°C to $+85^{\circ}\text{C}$), unless otherwise noted.

Table 4.

Parameter	Conditions ¹	Min	Typ	Max	Unit
f_{CLKIN}	SD/ED		27		MHz
	ED (at 54 MHz)		54		MHz
	HD		74.25		MHz
CLKIN High Time, t_g		40			% of one clock cycle
CLKIN Low Time, t_{l0}		40			% of one clock cycle
CLKIN Peak-to-Peak Jitter Tolerance			2		\pm ns

¹ SD = standard definition, ED = enhanced definition (525p/625p), HD = high definition.

ANALOG OUTPUT SPECIFICATIONS

$V_{DD} = 1.71\text{ V to }1.89\text{ V}$, $PV_{DD} = 1.71\text{ V to }1.89\text{ V}$, $V_{AA} = 2.6\text{ V to }3.465\text{ V}$, $V_{DD_IO} = 1.71\text{ V to }3.63\text{ V}$. All specifications T_{MIN} to T_{MAX} (-40°C to $+85^{\circ}\text{C}$), unless otherwise noted.

Table 5.

Parameter	Conditions	Min	Typ	Max	Unit
Full-Drive Output Current	$R_{SET} = 510\ \Omega$, $R_L = 37.5\ \Omega$ All DACs enabled	33	34.6	37	mA
	$R_{SET} = 510\ \Omega$, $R_L = 37.5\ \Omega$ DAC 1 enabled only ¹	31.5	33.5	37	mA
Low-Drive Output Current	$R_{SET} = 4.12\ \text{k}\Omega$, $R_L = 300\ \Omega$		4.3		mA
DAC-to-DAC Matching	DAC 1, DAC 2, DAC 3		2.0		%
Output Compliance, V_{OC}		0		1.4	V
Output Capacitance, C_{OUT}			10		pF
Analog Output Delay ²			6		ns
DAC Analog Output Skew	DAC 1, DAC 2, DAC 3		1		ns

¹ The recommended method of bringing this value back to the ideal value is by adjusting Register 0x0B to the recommended value of 0x12.

² Output delay measured from the 50% point of the rising edge of the input clock to the 50% point of the DAC output full-scale transition.

SPECIFICATIONS

DIGITAL INPUT/OUTPUT SPECIFICATIONS—3.3 V

$V_{DD} = 1.71\text{ V to }1.89\text{ V}$, $PV_{DD} = 1.71\text{ V to }1.89\text{ V}$, $V_{AA} = 2.6\text{ V to }3.465\text{ V}$, $V_{DD_IO} = 2.97\text{ V to }3.63\text{ V}$. All specifications T_{MIN} to T_{MAX} (-40°C to $+85^{\circ}\text{C}$), unless otherwise noted.

Table 6.

Parameter	Conditions	Min	Typ	Max	Unit
Input High Voltage, V_{IH}		2.0			V
Input Low Voltage, V_{IL}				0.8	V
Input Leakage Current, I_{IN}	$V_{IN} = V_{DD_IO}$			± 10	μA
Input Capacitance, C_{IN}			4		pF
Output High Voltage, V_{OH}	$I_{SOURCE} = 400\ \mu\text{A}$	2.4			V
Output Low Voltage, V_{OL}	$I_{SINK} = 3.2\ \text{mA}$			0.4	V
Three-State Leakage Current	$V_{IN} = 0.4\ \text{V}, 2.4\ \text{V}$			± 1	μA
Three-State Output Capacitance			4		pF

DIGITAL INPUT/OUTPUT SPECIFICATIONS—1.8 V

When V_{DD_IO} is set to 1.8 V, all the digital video inputs and control inputs, such as I^2C , HS, and VS, should use 1.8 V levels. $V_{DD} = 1.71\text{ V to }1.89\text{ V}$, $PV_{DD} = 1.71\text{ V to }1.89\text{ V}$, $V_{AA} = 2.6\text{ V to }3.465\text{ V}$, $V_{DD_IO} = 1.71\text{ V to }1.89\text{ V}$. All specifications T_{MIN} to T_{MAX} (-40°C to $+85^{\circ}\text{C}$), unless otherwise noted.

Table 7.

Parameter	Conditions	Min	Typ	Max	Unit
Input High Voltage, V_{IH}		$0.7 V_{DD_IO}$			V
Input Low Voltage, V_{IL}				$0.3 V_{DD_IO}$	V
Input Capacitance, C_{IN}			4		pF
Output High Voltage, V_{OH}	$I_{SOURCE} = 400\ \mu\text{A}$	$V_{DD_IO} - 0.4$			V
Output Low Voltage, V_{OL}	$I_{SINK} = 3.2\ \text{mA}$			0.4	V
Three-State Output Capacitance			4		pF

MPU PORT TIMING SPECIFICATIONS

$V_{DD} = 1.71\text{ V to }1.89\text{ V}$, $PV_{DD} = 1.71\text{ V to }1.89\text{ V}$, $V_{AA} = 2.6\text{ V to }3.465\text{ V}$, $V_{DD_IO} = 1.71\text{ V to }3.63\text{ V}$. All specifications T_{MIN} to T_{MAX} (-40°C to $+85^{\circ}\text{C}$), unless otherwise noted.

Table 8.

Parameter	Conditions	Min	Typ	Max	Unit
MPU PORT, I^2C MODE ¹	See Figure 17				
SCL Frequency		0		400	kHz
SCL High Pulse Width, t_1		0.6			μs
SCL Low Pulse Width, t_2		1.3			μs
Hold Time (Start Condition), t_3		0.6			μs
Setup Time (Start Condition), t_4		0.6			μs
Data Setup Time, t_5		100			ns
SDA, SCL Rise Time, t_6				300	ns
SDA, SCL Fall Time, t_7				300	ns
Setup Time (Stop Condition), t_8		0.6			μs

¹ Guaranteed by characterization.

SPECIFICATIONS

DIGITAL TIMING SPECIFICATIONS—3.3 V

$V_{DD} = 1.71\text{ V to }1.89\text{ V}$, $PV_{DD} = 1.71\text{ V to }1.89\text{ V}$, $V_{AA} = 2.6\text{ V to }3.465\text{ V}$, $V_{DD_IO} = 2.97\text{ V to }3.63\text{ V}$. All specifications T_{MIN} to T_{MAX} (-40°C to $+85^{\circ}\text{C}$), unless otherwise noted.

Table 9.

Parameter	Conditions ¹	Min	Typ	Max	Unit
VIDEO DATA AND VIDEO CONTROL PORT ^{2,3}					
Data Input Setup Time, t_{11} ⁴	SD	2.1			ns
	ED/HD-SDR	2.3			ns
	ED/HD-DDR	2.3			ns
	ED (at 54 MHz)	1.7			ns
Data Input Hold Time, t_{12} ⁴	SD	1.0			ns
	ED/HD-SDR	1.1			ns
	ED/HD-DDR	1.1			ns
	ED (at 54 MHz)	1.0			ns
Control Input Setup Time, t_{11} ⁴	SD	2.1			ns
	ED/HD-SDR or ED/HD-DDR	2.3			ns
	ED (at 54 MHz)	1.7			ns
Control Input Hold Time, t_{12} ⁴	SD	1.0			ns
	ED/HD-SDR or ED/HD-DDR	1.1			ns
	ED (at 54 MHz)	1.0			ns
Control Output Access Time, t_{13} ⁴	SD			12	ns
	ED/HD-SDR, ED/HD-DDR, or ED (at 54 MHz)			10	ns
Control Output Hold Time, t_{14} ⁴	SD	4.0			ns
	ED/HD-SDR, ED/HD-DDR, or ED (at 54 MHz)	3.5			ns
PIPELINE DELAY ⁵					
SD ¹					
CVBS/Y-C Outputs (2×)	SD oversampling disabled		68		Clock cycles
CVBS/Y-C Outputs (8×)	SD oversampling enabled		79		Clock cycles
CVBS/Y-C Outputs (16×)	SD oversampling enabled		67		Clock cycles
Component Outputs (2×)	SD oversampling disabled		78		Clock cycles
Component Outputs (8×)	SD oversampling enabled		69		Clock cycles
Component Outputs (16×)	SD oversampling enabled		84		Clock cycles
ED ¹					
Component Outputs (1×)	ED oversampling disabled		41		Clock cycles
Component Outputs (4×)	ED oversampling enabled		49		Clock cycles
Component Outputs (8×)	ED oversampling enabled		46		Clock cycles
HD ¹					
Component Outputs (1×)	HD oversampling disabled		40		Clock cycles
Component Outputs (2×)	HD oversampling enabled		42		Clock cycles
Component Outputs (4×)	HD oversampling enabled		44		Clock cycles
RESET CONTROL					
RESET Low Time		100			ns

¹ SD = standard definition, ED = enhanced definition (525p/625p), HD = high definition, SDR = single data rate, DDR = dual data rate.

² Video data: P[15:0] for ADV7392/ADV7393 or P[7:0] for ADV7390/ADV7391.

³ Video control: $\overline{\text{HSYNC}}$ and $\overline{\text{VSYNC}}$.

⁴ Guaranteed by characterization.

⁵ Guaranteed by design.

SPECIFICATIONS

DIGITAL TIMING SPECIFICATIONS—1.8 V

$V_{DD} = 1.71\text{ V to }1.89\text{ V}$, $PV_{DD} = 1.71\text{ V to }1.89\text{ V}$, $V_{AA} = 2.6\text{ V to }3.465\text{ V}$, $V_{DD_IO} = 1.71\text{ V to }1.89\text{ V}$. All specifications T_{MIN} to T_{MAX} (-40°C to $+85^{\circ}\text{C}$), unless otherwise noted.

Table 10.

Parameter	Conditions ¹	Min	Typ	Max	Unit
VIDEO DATA AND VIDEO CONTROL PORT ^{2,3}					
Data Input Setup Time, t_{11} ⁴	SD	1.4			ns
	ED/HD-SDR	1.9			ns
	ED/HD-DDR	1.9			ns
	ED (at 54 MHz)	1.6			ns
Data Input Hold Time, t_{12} ⁴	SD	1.4			ns
	ED/HD-SDR	1.5			ns
	ED/HD-DDR	1.5			ns
	ED (at 54 MHz)	1.3			ns
Control Input Setup Time, t_{11} ⁴	SD	1.4			ns
	ED/HD-SDR or ED/HD-DDR	1.2			ns
	ED (at 54 MHz)	1.0			ns
	ED (at 54 MHz)	1.0			ns
Control Input Hold Time, t_{12} ⁴	SD	1.4			ns
	ED/HD-SDR or ED/HD-DDR	1.0			ns
	ED (at 54 MHz)	1.0			ns
Control Output Access Time, t_{13} ⁴	SD			13	ns
	ED/HD-SDR, ED/HD-DDR, or ED (at 54 MHz)			12	ns
Control Output Hold Time, t_{14} ⁴	SD	4.0			ns
	ED/HD-SDR, ED/HD-DDR, or ED (at 54 MHz)	5.0			ns
PIPELINE DELAY ⁵					
SD ¹					
CVBS/Y-C Outputs (2×)	SD oversampling disabled		68		Clock cycles
CVBS/Y-C Outputs (8×)	SD oversampling enabled		79		Clock cycles
CVBS/Y-C Outputs (16×)	SD oversampling enabled		67		Clock cycles
Component Outputs (2×)	SD oversampling disabled		78		Clock cycles
Component Outputs (8×)	SD oversampling enabled		69		Clock cycles
Component Outputs (16×)	SD oversampling enabled		84		Clock cycles
ED ¹					
Component Outputs (1×)	ED oversampling disabled		41		Clock cycles
Component Outputs (4×)	ED oversampling enabled		49		Clock cycles
Component Outputs (8×)	ED oversampling enabled		46		Clock cycles
HD ¹					
Component Outputs (1×)	HD oversampling disabled		40		Clock cycles
Component Outputs (2×)	HD oversampling enabled		42		Clock cycles
Component Outputs (4×)	HD oversampling enabled		44		Clock cycles
RESET CONTROL					
RESET Low Time		100			ns

¹ SD = standard definition, ED = enhanced definition (525p/625p), HD = high definition, SDR = single data rate, DDR = dual data rate.

² Video data: P[15:0] for ADV7392/ADV7393 or P[7:0] for ADV7390/ADV7391.

³ Video control: $\overline{\text{HSYNC}}$ and $\overline{\text{VSYNC}}$.

⁴ Guaranteed by characterization.

⁵ Guaranteed by design.

SPECIFICATIONS

VIDEO PERFORMANCE SPECIFICATIONS

$V_{DD} = 1.8\text{ V}$, $PV_{DD} = 1.8\text{ V}$, $V_{AA} = 3.3\text{ V}$, $V_{DD_IO} = 3.3\text{ V}$, $T_A = +25^\circ\text{C}$.

Table 11.

Parameter	Conditions	Min	Typ	Max	Unit
STATIC PERFORMANCE					
Resolution			10		Bits
Integral Nonlinearity (INL) ¹	$R_{SET} = 510\ \Omega$, $R_L = 37.5\ \Omega$		0.5		LSBs
Differential Nonlinearity (DNL) ^{1,2}	$R_{SET} = 510\ \Omega$, $R_L = 37.5\ \Omega$		0.5		LSBs
STANDARD DEFINITION (SD) MODE					
Luminance Nonlinearity			0.5		±%
Differential Gain	NTSC		0.5		%
Differential Phase	NTSC		0.6		Degrees
Signal-to-Noise Ratio (SNR) ³	Luma ramp		58		dB
	Flat field full bandwidth		75		dB
ENHANCED DEFINITION (ED) MODE					
Luma Bandwidth			12.5		MHz
Chroma Bandwidth			5.8		MHz
HIGH DEFINITION (HD) MODE					
Luma Bandwidth			30.0		MHz
Chroma Bandwidth			13.75		MHz

¹ Measured on DAC 1, DAC 2, and DAC 3.

² Differential nonlinearity (DNL) measures the deviation of the actual DAC output voltage step from the ideal. For +ve DNL, the actual step value lies above the ideal step value. For -ve DNL, the actual step value lies below the ideal step value.

³ Measured on the ADV7392/ADV7393 operating in 10-bit input mode.

POWER SPECIFICATIONS

$V_{DD} = 1.8\text{ V}$, $PV_{DD} = 1.8\text{ V}$, $V_{AA} = 3.3\text{ V}$, $V_{DD_IO} = 3.3\text{ V}$, $T_A = +25^\circ\text{C}$.

Table 12.

Parameter	Conditions	Min	Typ	Max	Unit
NORMAL POWER MODE ^{1,2}					
I_{DD} ³	SD (16× oversampling enabled), CVBS (only one DAC turned on)		33		mA
	SD (16× oversampling enabled), YPrPb (three DACs turned on)		68		mA
	ED (8× oversampling enabled) ⁴		59		mA
	HD (4× oversampling enabled) ⁴		81	101	mA
I_{DD_IO}			1	10	mA
I_{AA} ⁵	One DAC enabled		50		mA
	All DACs enabled		122	151	mA
I_{PLL}			4	10	mA
SLEEP MODE					
I_{DD}			5		μA
I_{AA}			0.3		μA
I_{DD_IO}			0.2		μA
I_{PLL}			0.1		μA

¹ $R_{SET} = 510\ \Omega$ (all DACs operating in full-drive mode).

² 75% color bar test pattern applied to pixel data pins.

SPECIFICATIONS

- ³ I_{DD} is the continuous current required to drive the digital core.
- ⁴ Applicable to both single data rate (SDR) and dual data rate (DDR) input modes.
- ⁵ I_{AA} is the total current required to supply all DACs.

TIMING DIAGRAMS

The following abbreviations are used in Figure 4 to Figure 11:

- ▶ t_g = clock high time
- ▶ t_{l0} = clock low time
- ▶ t_{11} = data setup time
- ▶ t_{12} = data hold time
- ▶ t_{13} = control output access time
- ▶ t_{14} = control output hold time

In addition, see Table 35 for the ADV7390/ADV7391 pixel port input configuration and Table 36 for the ADV7392/ADV7393 pixel port input configuration.

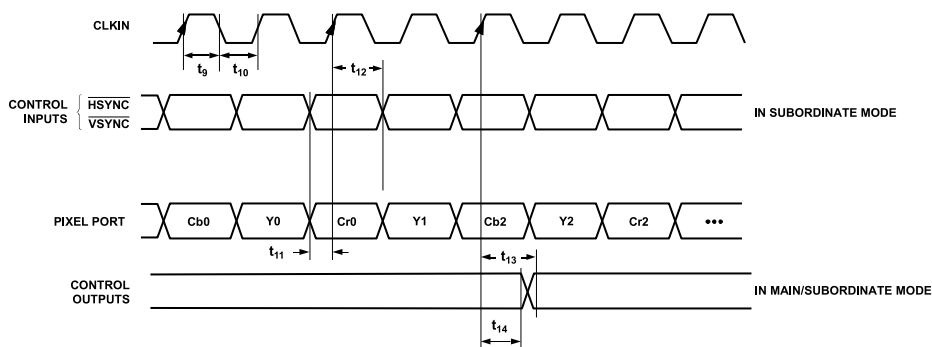

Figure 4. SD Input, 8-/10-Bit 4:2:2 YCrCb, Input Mode 000

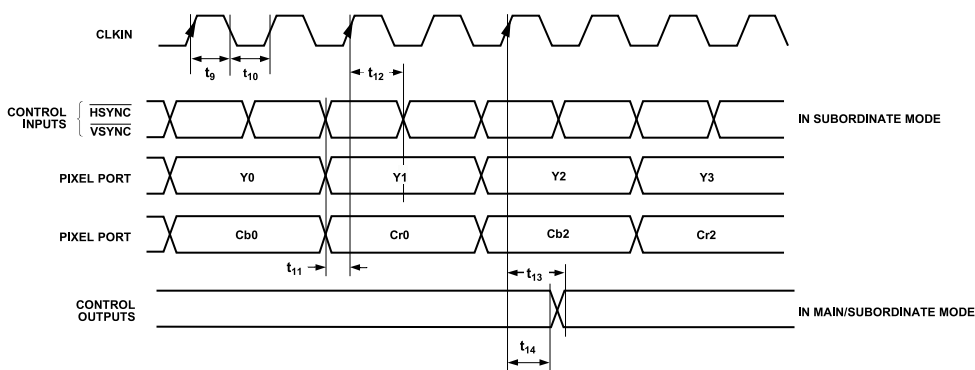
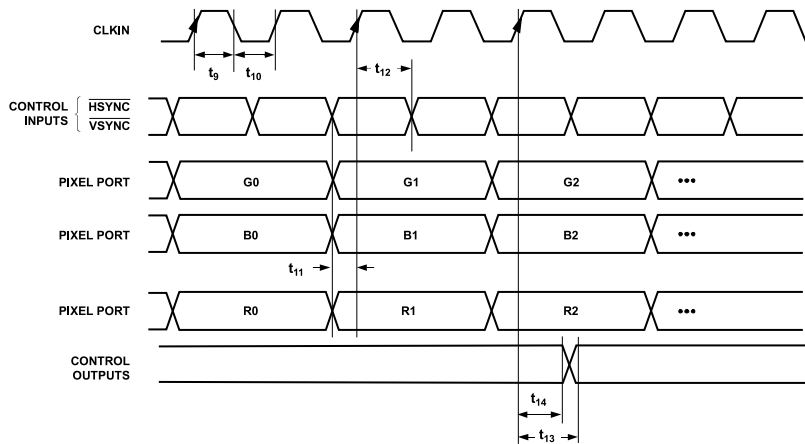

Figure 5. SD Input, 16-Bit 4:2:2 YCrCb, Input Mode 000

SPECIFICATIONS



004

Figure 6. SD Input, 16-Bit 4:4:4 RGB, Input Mode 000

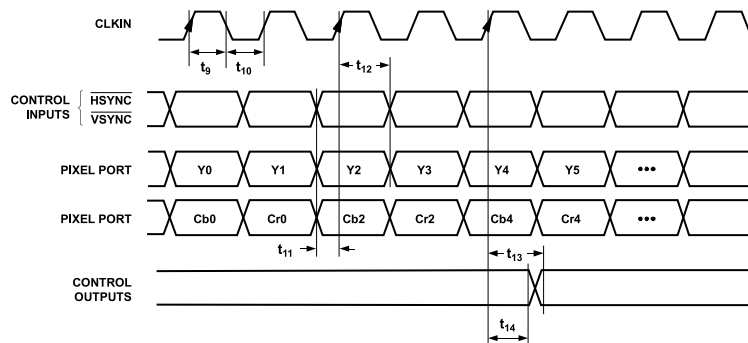

005

Figure 7. ED/HD-SDR Input, 16-Bit 4:2:2 YCrCb, Input Mode 001

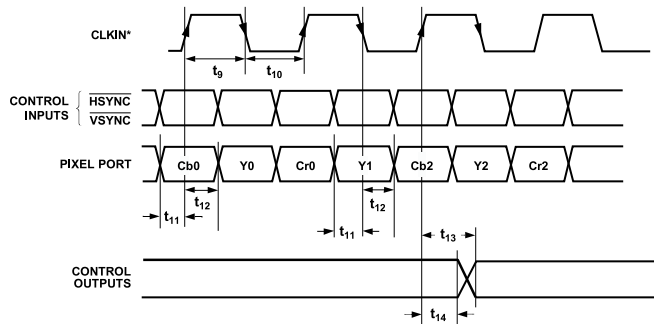

006

*LUMA/CHROMA CLOCK RELATIONSHIP CAN BE INVERTED USING SUBADDRESS 0x01, BITS 1 AND 2.

Figure 8. ED/HD-DDR Input, 8-/10-Bit 4:2:2 YCrCb (HSYNC/VSYNC), Input Mode 010

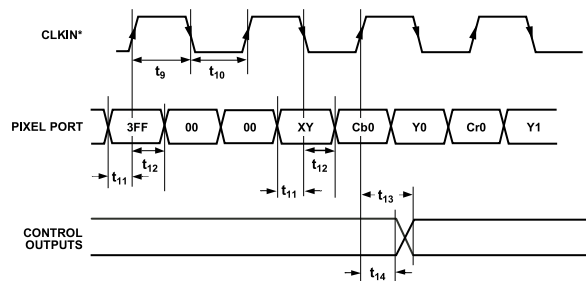

007

*LUMA/CHROMA CLOCK RELATIONSHIP CAN BE INVERTED USING SUBADDRESS 0x01, BITS 1 AND 2.

Figure 9. ED/HD-DDR Input, 8-/10-Bit 4:2:2 YCrCb (EAV/SAV), Input Mode 010

SPECIFICATIONS

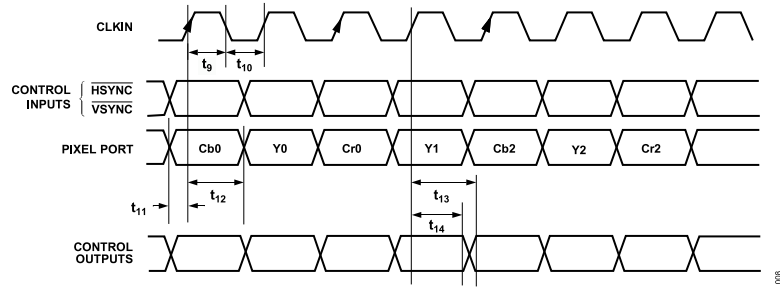

Figure 10. ED (at 54 MHz) Input, 8-/10-Bit 4:2:2 YCrCb (HSYNC/VSYNC), Input Mode 111

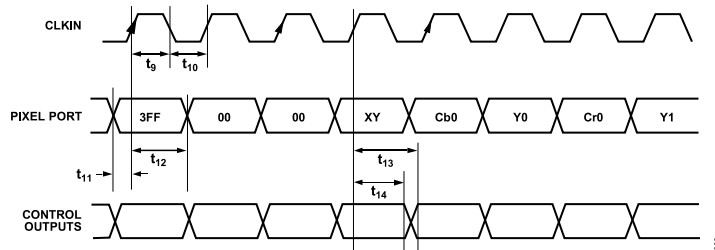
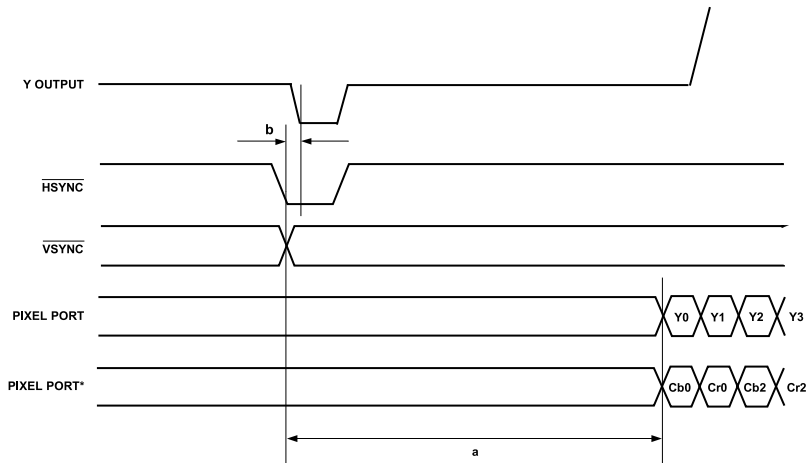

Figure 11. ED (at 54 MHz) Input, 8-/10-Bit 4:2:2 YCrCb (EAV/SAV), Input Mode 111



a = AS PER RELEVANT STANDARD.

b = PIPELINE DELAY. PLEASE REFER TO RELEVANT PIPELINE DELAY. THIS CAN BE FOUND IN THE DIGITAL TIMING SPECIFICATION SECTION OF THE DATA SHEET.

A FALLING EDGE OF HSYNC INTO THE ENCODER GENERATES A SYNC FALLING EDGE ON THE OUTPUT AFTER A TIME EQUAL TO THE PIPELINE DELAY.

Figure 12. ED-SDR, 16-Bit 4:2:2 YCrCb (HSYNC/VSYNC) Input Timing Diagram

SPECIFICATIONS

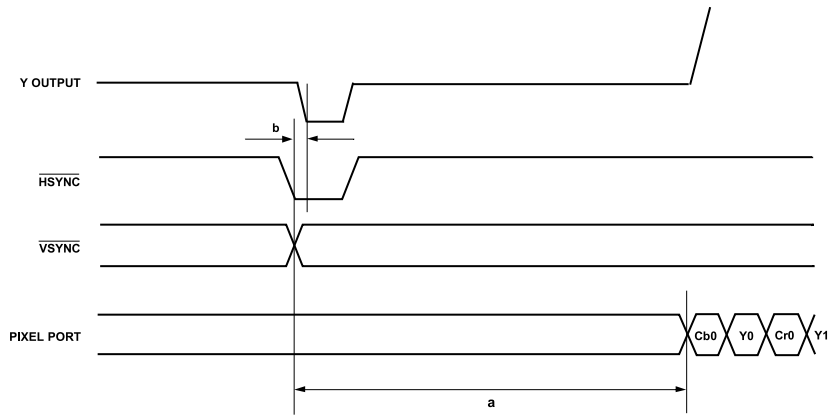

a(MIN) = 244 CLOCK CYCLES FOR 525p.
 a(MIN) = 264 CLOCK CYCLES FOR 625p.

b = PIPELINE DELAY. PLEASE REFER TO RELEVANT PIPELINE DELAY. THIS CAN BE FOUND IN THE DIGITAL TIMING SPECIFICATION SECTION OF THE DATA SHEET.

A FALLING EDGE OF HSYNC INTO THE ENCODER GENERATES A SYNC FALLING EDGE ON THE OUTPUT AFTER A TIME EQUAL TO THE PIPELINE DELAY.

011

Figure 13. ED-DDR, 8-/10-Bit 4:2:2 YCrCb (HSYNC/VSYNC) Input Timing Diagram

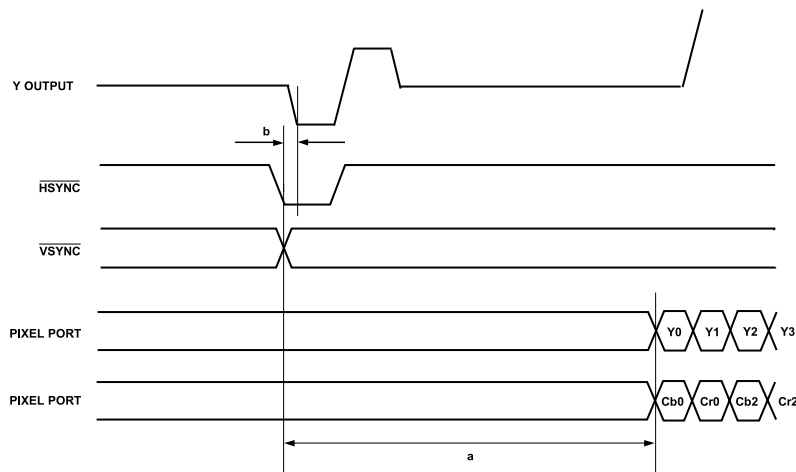

a = AS PER RELEVANT STANDARD.

b = PIPELINE DELAY. PLEASE REFER TO RELEVANT PIPELINE DELAY. THIS CAN BE FOUND IN THE DIGITAL TIMING SPECIFICATION SECTION OF THE DATA SHEET.

A FALLING EDGE OF HSYNC INTO THE ENCODER GENERATES A FALLING EDGE OF TRI-LEVEL SYNC ON THE OUTPUT AFTER A TIME EQUAL TO THE PIPELINE DELAY.

012

Figure 14. HD-SDR, 16-Bit 4:2:2 YCrCb (HSYNC/VSYNC) Input Timing Diagram

SPECIFICATIONS

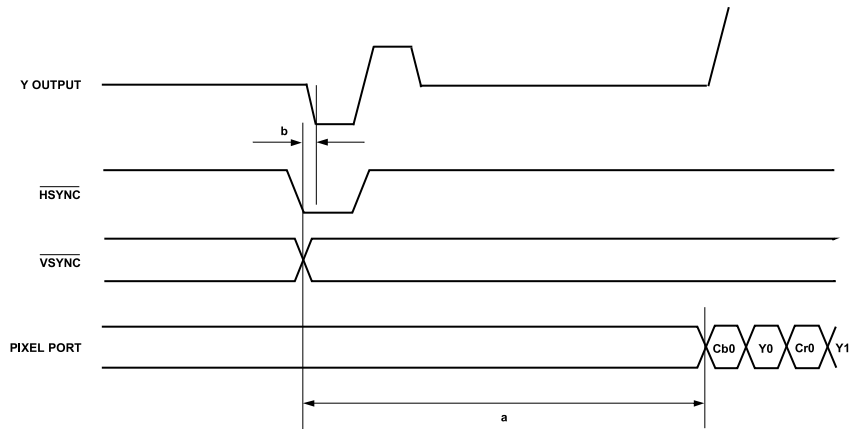

a = AS PER RELEVANT STANDARD.

b = PIPELINE DELAY. PLEASE REFER TO RELEVANT PIPELINE DELAY. THIS CAN BE FOUND IN THE DIGITAL TIMING SPECIFICATION SECTION OF THE DATA SHEET.

A FALLING EDGE OF HSYNC INTO THE ENCODER GENERATES A FALLING EDGE OF TRI-LEVEL SYNC ON THE OUTPUT AFTER A TIME EQUAL TO THE PIPELINE DELAY.

013

Figure 15. HD-DDR, 8-/10-Bit 4:2:2 YCrCb (HSYNC/VSYNC) Input Timing Diagram

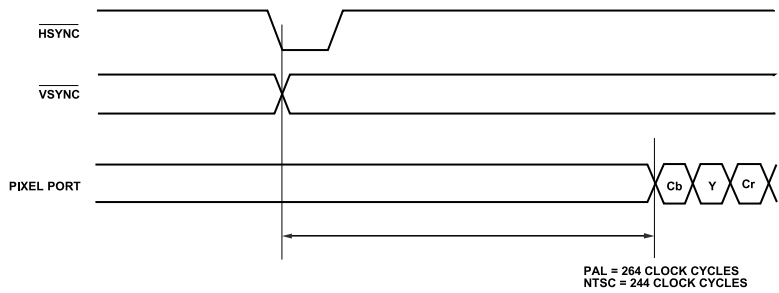

PAL = 264 CLOCK CYCLES
NTSC = 244 CLOCK CYCLES

014

Figure 16. SD Input Timing Diagram (Timing Mode 1)

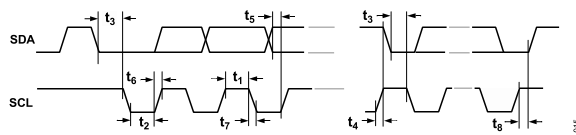

015

Figure 17. MPU Port Timing Diagram (I²C Mode)

ABSOLUTE MAXIMUM RATINGS

Table 13.

Parameter ¹	Rating
V _{AA} to AGND	-0.3 V to +3.9 V
V _{DD} to DGND	-0.3 V to +2.3 V
PV _{DD} to PGND	-0.3 V to +2.3 V
V _{DD_IO} to GND_IO	-0.3 V to +3.9 V
AGND to DGND	-0.3 V to +0.3 V
AGND to PGND	-0.3 V to +0.3 V
AGND to GND_IO	-0.3 V to +0.3 V
DGND to PGND	-0.3 V to +0.3 V
DGND to GND_IO	-0.3 V to +0.3 V
PGND to GND_IO	-0.3 V to +0.3 V
Digital Input Voltage to GND_IO	-0.3 V to V _{DD_IO} + 0.3 V
Analog Outputs to AGND	-0.3 V to V _{AA}
Max CLKIN Input Frequency	80 MHz
Storage Temperature Range (t _s)	-60°C to +150°C
Junction Temperature (t _j)	150°C
Lead Temperature (Soldering, 10 sec)	260°C

¹ Analog output short circuit to any power supply or common can be of an indefinite duration.

Stresses at or above those listed under Absolute Maximum Ratings may cause permanent damage to the product. This is a stress rating only; functional operation of the product at these or any other conditions above those indicated in the operational section of this specification is not implied. Operation beyond the maximum operating conditions for extended periods may affect product reliability.

THERMAL RESISTANCE

θ_{JA} is specified for the worst-case conditions, that is, a device soldered in a circuit board for surface-mount packages.

Table 14. Thermal Resistance¹

Package Type	θ_{JA} ²	θ_{JC-TOP} ³	$\theta_{JC-BOTTOM}$ ⁴	Unit
30-Ball WLCSP	35	1	N/A	°C/W
32-Lead LFCSP	27	32	1.2	°C/W
40-Lead LFCSP	26	32	1	°C/W

¹ Values are based on a JEDEC 4-layer test board.

² With the exposed metal paddle on the underside of the LFCSP soldered to the PCB ground.

³ This is the thermal resistance of the junction to the top of the package.

⁴ This is the thermal resistance of the junction to the bottom of the package.

The ADV7390/ADV7391/ADV7392/ADV7393 are RoHS-compliant, Pb-free products. The lead finish is 100% pure Sn electroplate. The device is suitable for Pb-free applications up to 255°C (±5°C) IR reflow (JEDEC STD-20).

The ADV7390/ADV7391/ADV7392/ADV7393 are backward compatible with conventional SnPb soldering processes. The electroplated Sn coating can be soldered with SnPb solder pastes at conventional reflow temperatures of 220°C to 235°C.

ESD CAUTION



ESD (electrostatic discharge) sensitive device. Charged devices and circuit boards can discharge without detection. Although this product features patented or proprietary protection circuitry, damage may occur on devices subjected to high energy ESD. Therefore, proper ESD precautions should be taken to avoid performance degradation or loss of functionality.

PIN CONFIGURATIONS AND FUNCTION DESCRIPTIONS

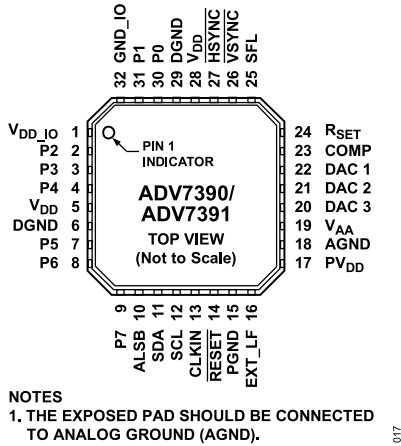

Figure 18. ADV7390/ADV7391 Pin Configuration (CP-32-3)

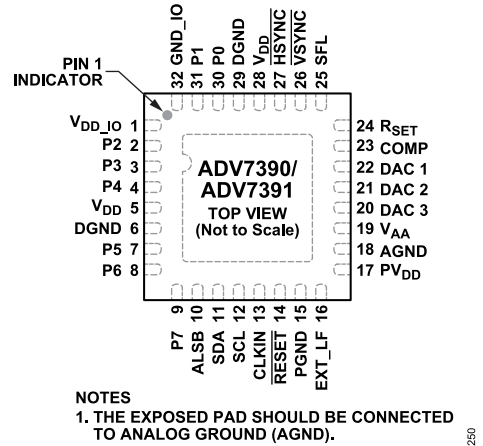

Figure 20. ADV7390/ADV7391 Pin Configuration (CP-32-13)

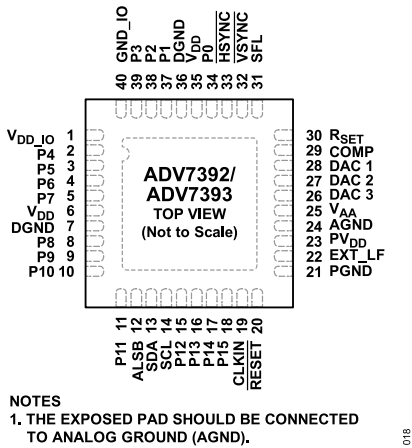

Figure 19. ADV7392/ADV7393 Pin Configuration (CP-40-9)

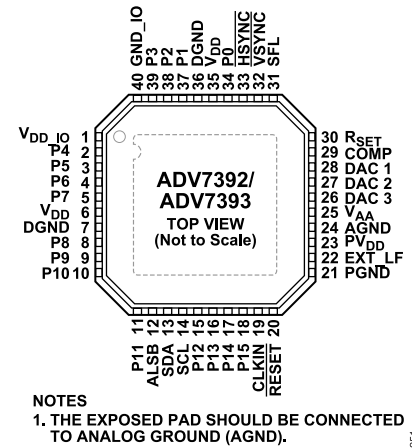

Figure 21. ADV7392/ADV7393 Pin Configuration (CP-40-1)

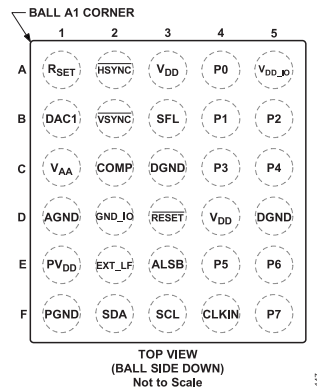

Figure 22. ADV7390BCBZ-A Pin Configuration

Table 15. Pin Function Descriptions

Pin No. ¹					
ADV7390/ ADV7391	ADV7392/ ADV7393	ADV7390 WLCSP	Mnemonic	Input/ Output	Description
9 to 7, 4 to 2, 31, 30	N/A	F5, E5, E4, C5, C4, B5, B4, A4	P7 to P0	I	8-Bit Pixel Port (P7 to P0). P0 is the LSB. See Table 35 for input modes (ADV7390/ADV7391).

PIN CONFIGURATIONS AND FUNCTION DESCRIPTIONS

Table 15. Pin Function Descriptions (Continued)

Pin No. ¹					
ADV7390/ ADV7391	ADV7392/ ADV7393	ADV7390 WLCSP	Mnemonic	Input/ Output	Description
N/A	18 to 15, 11 to 8, 5 to 2, 39 to 37, 34	N/A	P15 to P0	I	16-Bit Pixel Port (P15 to P0). P0 is the LSB. See Table 36 for input modes (ADV7392/ADV7393).
13	19	F4	CLKIN	I	Pixel Clock Input for HD (74.25 MHz), ED ² (27 MHz or 54 MHz), or SD (27 MHz).
27	33	A2	$\overline{\text{HSYNC}}$	I/O	Horizontal Synchronization Signal. This pin can also be configured to output an SD, ED, or HD horizontal synchronization signal. See the External Horizontal and Vertical Synchronization Control section.
26	32	B2	$\overline{\text{VSYNC}}$	I/O	Vertical Synchronization Signal. This pin can also be configured to output an SD, ED, or HD vertical synchronization signal. See the External Horizontal and Vertical Synchronization Control section.
25	31	B3	SFL	I/O	Subcarrier Frequency Lock (SFL) Input.
24	30	A1	R _{SET}	I	Controls the amplitudes of the DAC 1, DAC 2, and DAC 3 outputs. For full-drive operation (for example, into a 37.5 Ω load), a 510 Ω resistor must be connected from R _{SET} to AGND. For low-drive operation (for example, into a 300 Ω load), a 4.12 k Ω resistor must be connected from R _{SET} to AGND.
23	29	C2	COMP	O	Compensation Pin. Connect a 2.2 nF capacitor from COMP to V _{AA} .
N/A	N/A	B1	DAC 1	O	DAC Output. Full-drive and low-drive capable DAC
22, 21, 20	28, 27, 26	N/A	DAC 1, DAC 2, DAC 3	O	DAC Outputs. Full-drive and low-drive capable DACs.
12	14	F3	SCL	I	I ² C Clock Input.
11	13	F2	SDA	I/O	I ² C Data Input/Output.
10	12	E3	ALSB	I	ALSB sets up the LSB ³ of the MPU I ² C address.
14	20	D3	$\overline{\text{RESET}}$	I	Resets the on-chip timing generator and sets the ADV7390/ADV7391/ADV7392/ADV7393 into its default mode.
19	25	C1	V _{AA}	P	Analog Power Supply (2.7 V or 3.3 V).
5, 28	6, 35	A3, D4	V _{DD}	P	Digital Power Supply (1.8 V). For dual-supply configurations, V _{DD} can be connected to other 1.8 V supplies through a ferrite bead or suitable filtering.
1	1	A5	V _{DD_IO}	P	Input/Output Digital Power Supply (1.8 V or 3.3 V).
17	23	E1	PV _{DD}	P	PLL Power Supply (1.8 V). For dual-supply configurations, PV _{DD} can be connected to other 1.8 V supplies through a ferrite bead or suitable filtering.
16	22	E2	EXT_LF	I	External Loop Filter for the Internal PLL.
15	21	F1	PGND	G	PLL Ground Pin.
18	24	D1	AGND	G	Analog Ground Pin.
6, 29	7, 36	C3, D5	DGND	G	Digital Ground Pin.
32	40	D2	GND_IO	G	Input/Output Supply Ground Pin.
			EPAD	G	Exposed Pad. Connect to analog ground (AGND).

¹ N/A means not applicable.² ED = enhanced definition = 525p and 625p.³ LSB = least significant bit. In the ADV7390/ADV7392, setting the LSB to 0 sets the I²C address to 0x04. Setting it to 1 sets the I²C address to 0x06. In the ADV7391/ADV7393, setting the LSB to 0 sets the I²C address to 0x54. Setting it to 1 sets the I²C address to 0x56.

TYPICAL PERFORMANCE CHARACTERISTICS

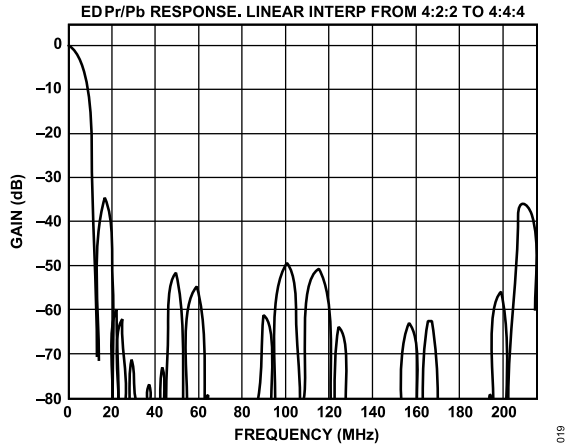

Figure 23. ED 8× Oversampling, PrPb Filter (Linear) Response

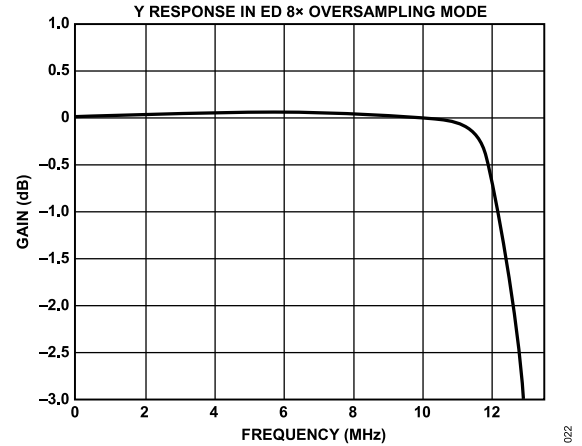

Figure 26. ED 8× Oversampling, Y Filter Response (Focus on Pass Band)

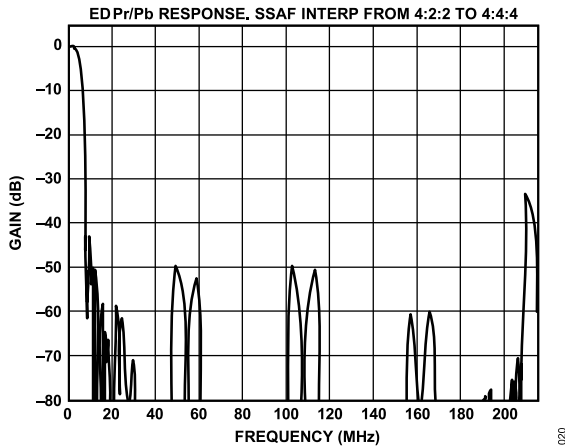

Figure 24. ED 8× Oversampling, PrPb Filter (SSAF™) Response

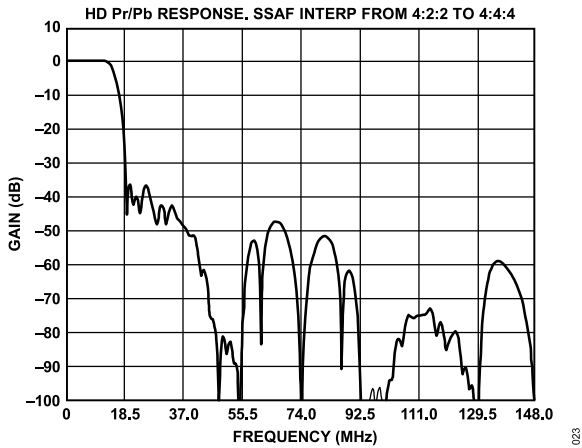

Figure 27. HD 4× Oversampling, PrPb (SSAF) Filter Response (4:2:2 Input)

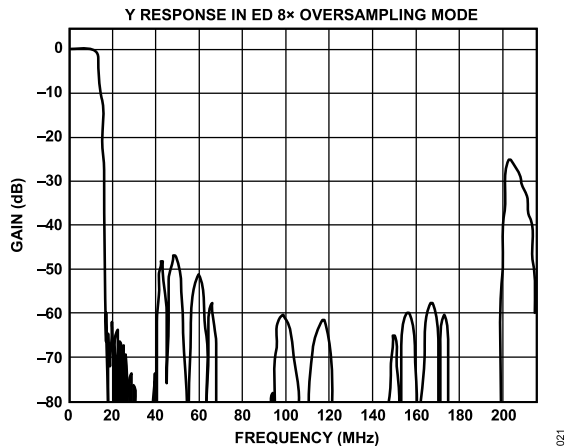

Figure 25. ED 8× Oversampling, Y Filter Response

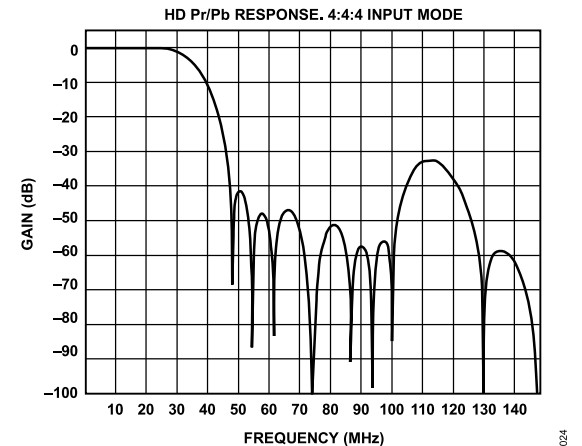

Figure 28. HD 4× Oversampling, PrPb (SSAF) Filter Response (4:4:4 Input)

TYPICAL PERFORMANCE CHARACTERISTICS

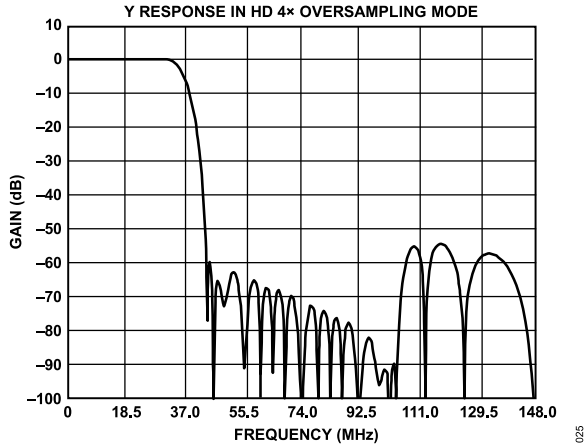

Figure 29. HD 4x Oversampling, Y Filter Response

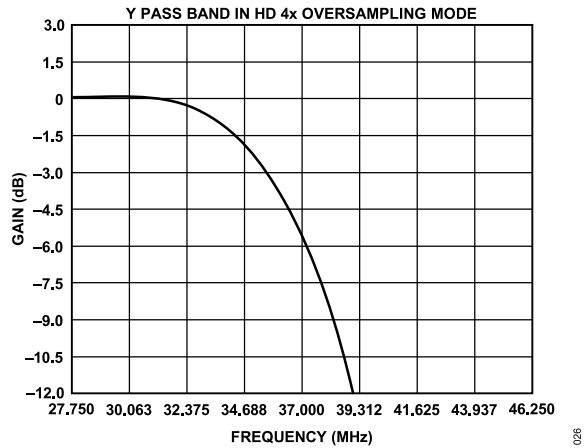

Figure 30. HD 4x Oversampling, Y Filter Response (Focus on Pass Band)

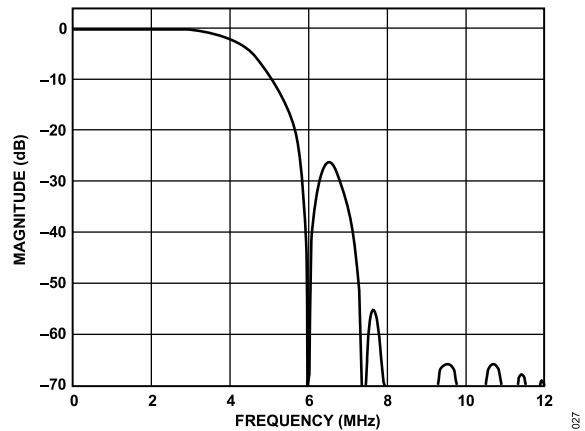

Figure 31. SD NTSC, Luma Low-Pass Filter Response

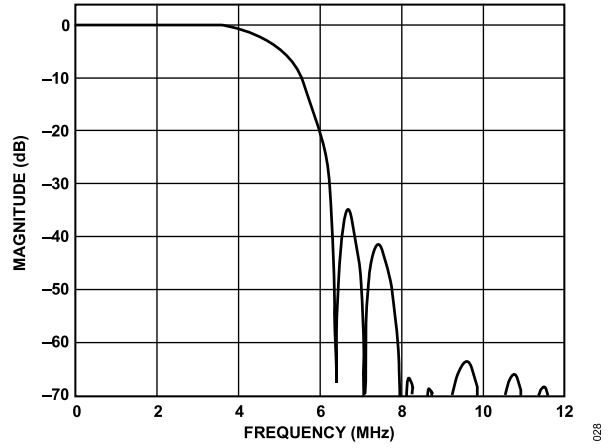

Figure 32. SD PAL, Luma Low-Pass Filter Response

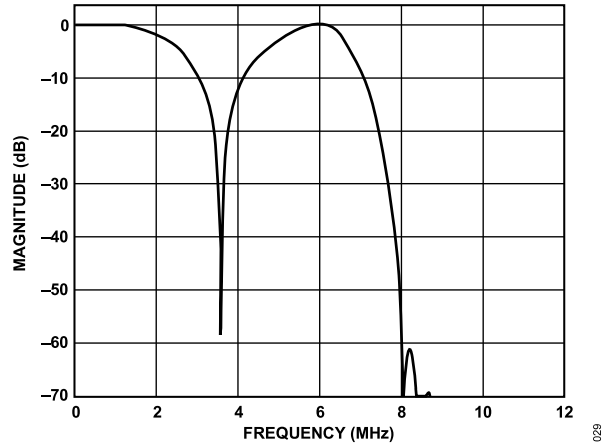

Figure 33. SD NTSC, Luma Notch Filter Response

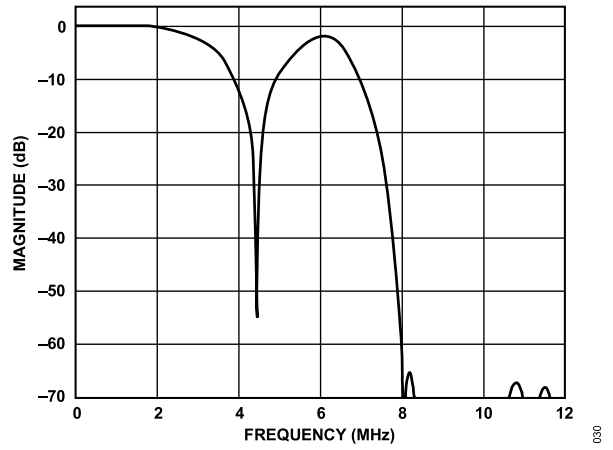

Figure 34. SD PAL, Luma Notch Filter Response

TYPICAL PERFORMANCE CHARACTERISTICS

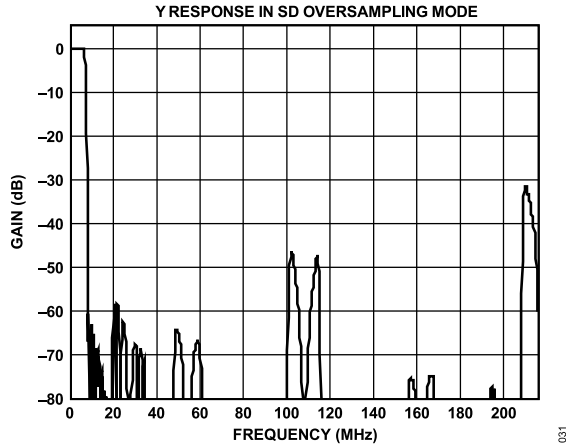

Figure 35. SD 16× Oversampling, Y Filter Response

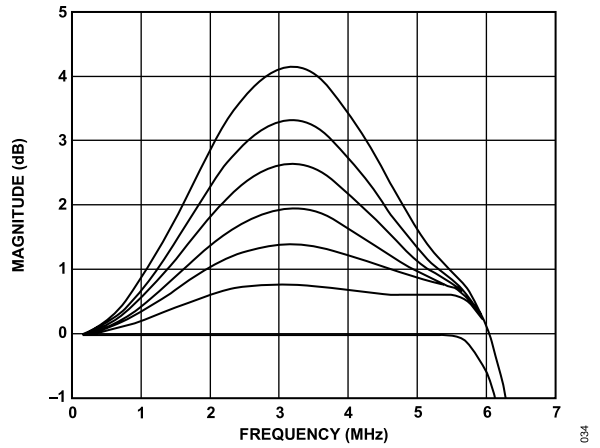

Figure 38. SD Luma SSAF Filter, Programmable Gain

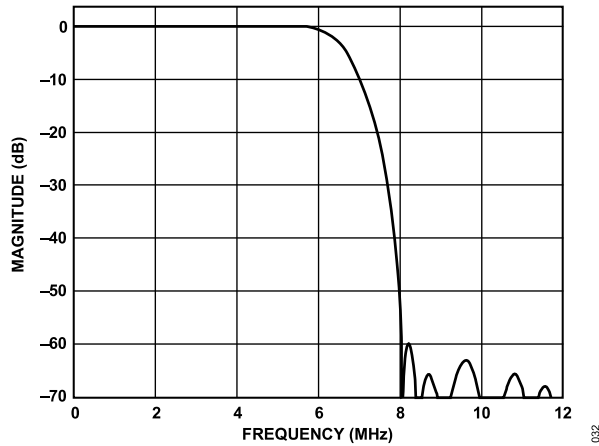

Figure 36. SD Luma SSAF Filter Response up to 12 MHz

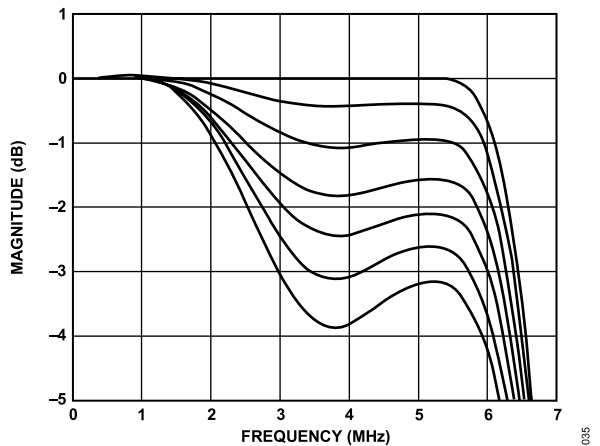

Figure 39. SD Luma SSAF Filter, Programmable Attenuation

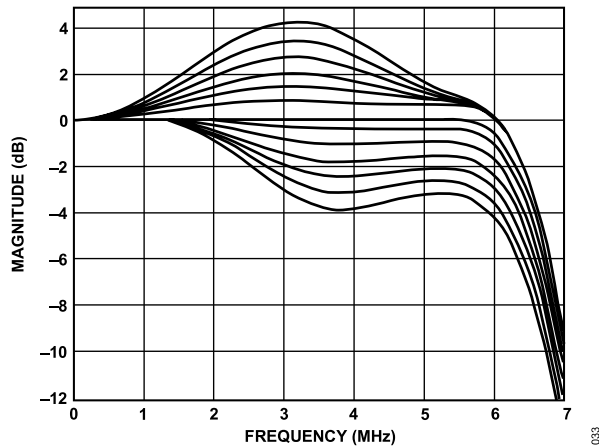

Figure 37. SD Luma SSAF Filter, Programmable Responses

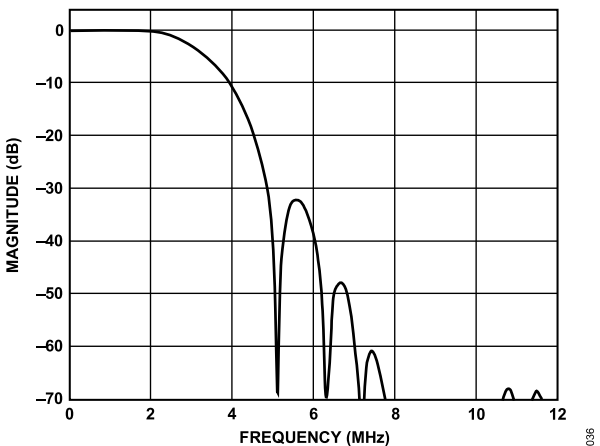

Figure 40. SD Luma CIF Low-Pass Filter Response

TYPICAL PERFORMANCE CHARACTERISTICS

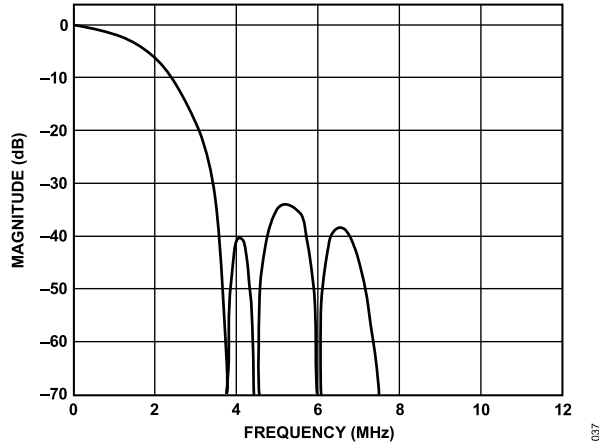

Figure 41. SD Luma QCIF Low-Pass Filter Response

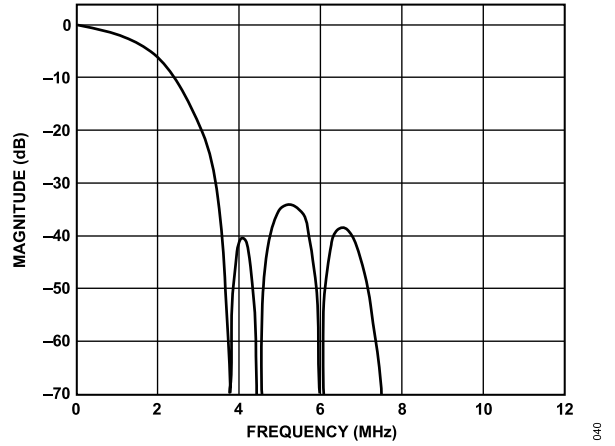

Figure 44. SD Chroma 1.3 MHz Low-Pass Filter Response

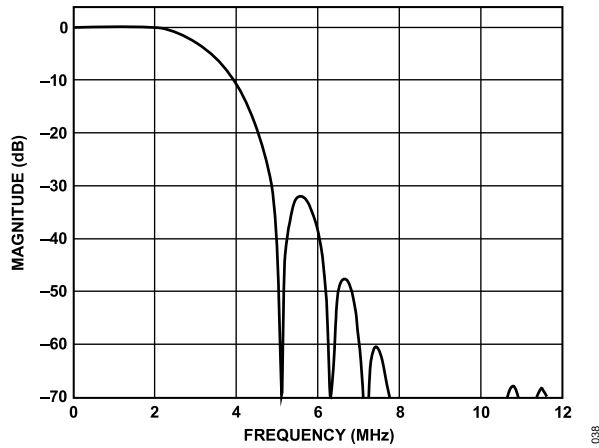

Figure 42. SD Chroma 3.0 MHz Low-Pass Filter Response

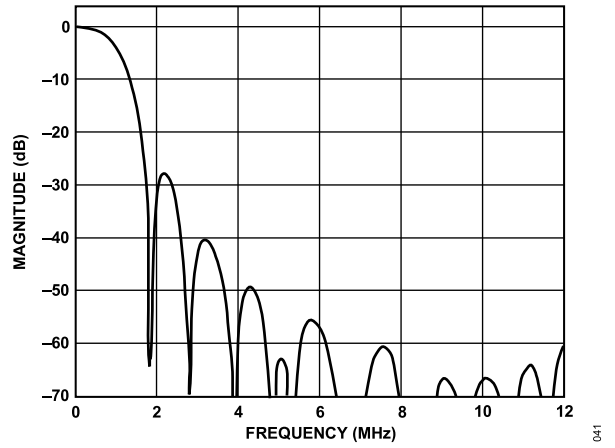

Figure 45. SD Chroma 1.0 MHz Low-Pass Filter Response

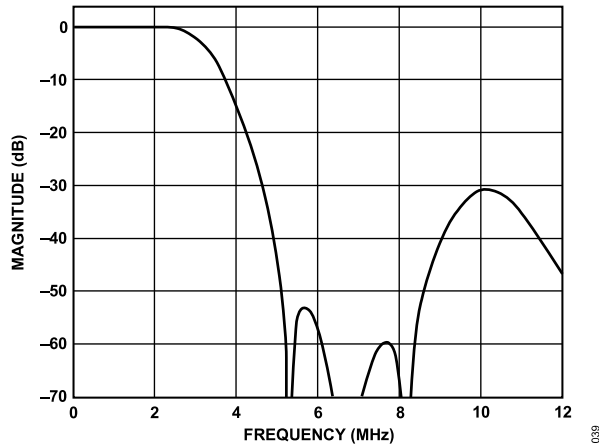

Figure 43. SD Chroma 2.0 MHz Low-Pass Filter Response

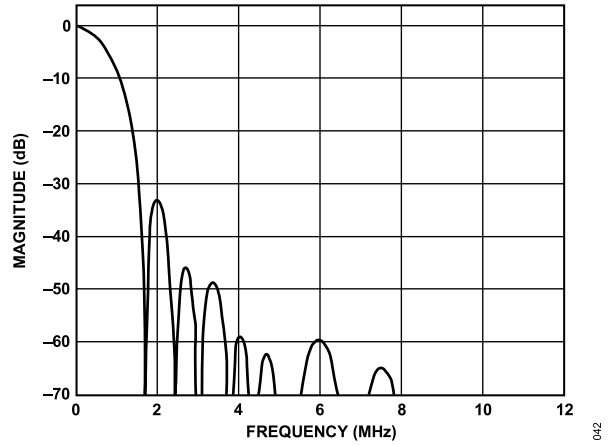

Figure 46. SD Chroma 0.65 MHz Low-Pass Filter Response

TYPICAL PERFORMANCE CHARACTERISTICS

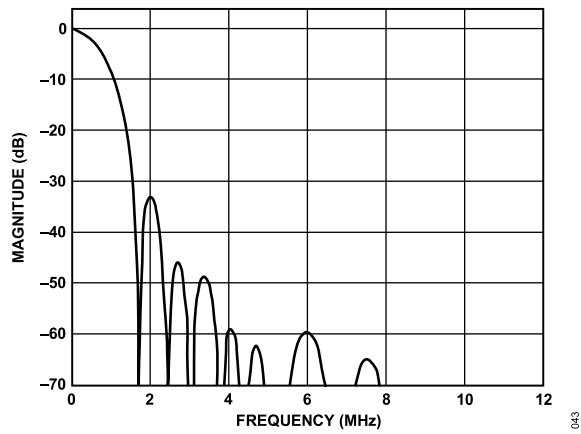

Figure 47. SD Chroma CIF Low-Pass Filter Response

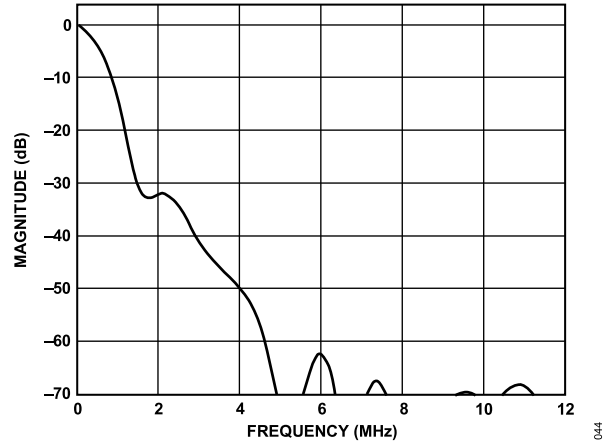

Figure 48. SD Chroma QCIF Low-Pass Filter Response

MPU PORT DESCRIPTION

Devices such as a microprocessor can communicate with the ADV7390/ADV7391/ADV7392/ADV7393 through a 2-wire serial (I²C-compatible) bus. After power-up or reset, the MPU port is configured for I²C operation.

I²C OPERATION

The ADV7390/ADV7391/ADV7392/ADV7393 support a 2-wire serial (I²C-compatible) microprocessor bus driving multiple peripherals. This port operates in an open-drain configuration. Two wires, serial data (SDA) and serial clock (SCL), carry information between any device connected to the bus and the ADV7390/ADV7391/ADV7392/ADV7393. The subordinate address depends on the device (ADV7390, ADV7391, ADV7392, or ADV7393), the operation (read or write), and the state of the ALSB pin (0 or 1). See [Table 16](#), [Figure 49](#), and [Figure 50](#). The LSB sets either a read or a write operation. Logic 1 corresponds to a read operation, and Logic 0 corresponds to a write operation. A1 is controlled by setting the ALSB pin of the ADV7390/ADV7391/ADV7392/ADV7393 to Logic 0 or Logic 1.

Table 16. ADV7390/ADV7391/ADV7392/ADV7393 I²C Subordinate Addresses

Device	ALSB	Operation	Subordinate Address
ADV7390 and ADV7392	0	Write	0xD4
	0	Read	0xD5
	1	Write	0xD6
	1	Read	0xD7
ADV7391 and ADV7393	0	Write	0x54
	0	Read	0x55
	1	Write	0x56
	1	Read	0x57

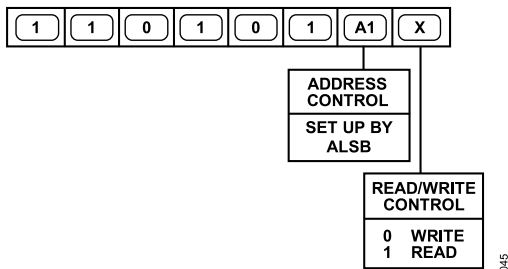

Figure 49. ADV7390/ADV7392 I²C Subordinate Address

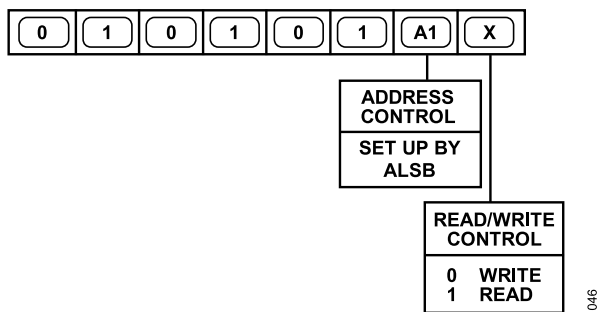

Figure 50. ADV7391/ADV7393 I²C Subordinate Address

The various devices on the bus use the following protocol. The main initiates a data transfer by establishing a start condition, defined by a high-to-low transition on SDA while SCL remains high. This indicates that an address/data stream follows. All peripherals respond to the start condition and shift the next eight bits (7-bit address plus the R/W bit).

The bits are transferred from MSB down to LSB. The peripheral that recognizes the transmitted address responds by pulling the data line low during the ninth clock pulse. This is known as an acknowledge bit. All other devices withdraw from the bus at this point and maintain an idle condition. The idle condition occurs when the device monitors the SDA and SCL lines waiting for the start condition and the correct transmitted address. The R/W bit determines the direction of the data.

Logic 0 on the LSB of the first byte means that the main writes information to the peripheral. Logic 1 on the LSB of the first byte means that the main reads information from the peripheral.

The ADV7390/ADV7391/ADV7392/ADV7393 act as a standard subordinate device on the bus. The data on the SDA pin is eight bits long, supporting the 7-bit addresses plus the R/W bit. It interprets the first byte as the device address and the second byte as the starting subaddress. There is a subaddress auto-increment facility. This allows data to be written to or read from registers in ascending subaddress sequence starting at any valid subaddress. A data transfer is always terminated by a stop condition. The user can also access any unique subaddress register on a one-by-one basis without updating all the registers.

Stop and start conditions can be detected at any stage during the data transfer. If these conditions are asserted out of sequence with normal read and write operations, they cause an immediate jump to the idle condition. During a given SCL high period, the user should issue only a start condition, a stop condition, or a stop condition followed by a start condition. If an invalid subaddress is issued by the user, the ADV7390/ADV7391/ADV7392/ADV7393 do not issue an acknowledge but returns to the idle condition. If the user uses the auto-increment method of addressing the encoder and exceeds the highest subaddress, the following actions are taken:

- ▶ In read mode, the highest subaddress register contents are output until the main device issues a no acknowledge. This indicates the end of a read. A no acknowledge condition occurs when the SDA line is not pulled low on the ninth pulse.
- ▶ In write mode, the data for the invalid byte is not loaded into any subaddress register, a no acknowledge is issued by the ADV7390/ADV7391/ADV7392/ADV7393, and the part returns to the idle condition.

[Figure 51](#) shows an example of data transfer for a write sequence and the start and stop conditions. [Figure 52](#) shows bus write and read sequences.

MPU PORT DESCRIPTION

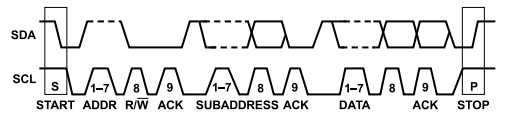

Figure 51. I²C Data Transfer

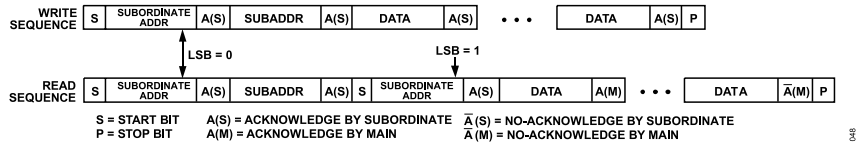

Figure 52. I²C Read and Write Sequence

REGISTER MAP ACCESS

A microprocessor can read from or write to all registers of the ADV7390/ADV7391/ADV7392/ADV7393 via the MPU port, except for registers that are specified as read-only or write-only registers.

The subaddress register determines the register accessed by the next read or write operation. All communication through the MPU port starts with an access to the subaddress register. A read/write operation is then performed from/to the target address, incrementing to the next address until the transaction is complete.

REGISTER PROGRAMMING

Table 17 to Table 34 describe the functionality of each register. All registers can be read from as well as written to, unless otherwise stated.

SUBADDRESS REGISTER (SR7 TO SR0)

The subaddress register is an 8-bit write-only register. After the MPU port is accessed and a read/write operation is selected, the subaddress is set up. The subaddress register determines which register performs the next operation.

Table 17. Register 0x00

SR7 to SR0	Register	Bit Description	Bit Number								Register Setting	Reset Value	
			7	6	5	4	3	2	1	0			
0x00	Power mode	Sleep mode. With this control enabled, the current consumption is reduced to μ A level. All DACs and the internal PLL circuit are disabled. Registers can be read from and written to in sleep mode.									0	Sleep mode off	0x12
											1	Sleep mode on	
		PLL and oversampling control. This control allows the internal PLL circuit to be powered down and the oversampling to be switched off.									0	PLL on	
											1	PLL off	
		DAC 3: power on/off.									0	DAC 3 off	
											1	DAC 3 on	
DAC 2: power on/off.								0		DAC 2 off			
								1		DAC 2 on			
DAC 1: power on/off.							0			DAC 1 off			
							1			DAC 1 on			
	Reserved.		0	0	0								

Table 18. Register 0x01 to Register 0x09

SR7 to SR0	Register	Bit Description	Bit Number ¹								Register Setting	Reset Value	
			7	6	5	4	3	2	1	0			
0x01	Mode select	Reserved.									0		0x00
		DDR clock edge alignment (used only for ED ² and HD DDR modes)								0	0	Chroma clocked in on rising clock edge and luma clocked in on falling clock edge.	
										0	1	Reserved.	
										1	0	Reserved.	
										1	1	Luma clocked in on rising clock edge and chroma clocked in on falling clock edge.	
		Reserved							0				
		Input mode (see Subaddress 0x30, Bits[7:3] for ED/HD standard selection)	0 0 0	SD input.									
0 0 1	ED/HD-SDR input. ³												
0 1 0	ED/HD-DDR input.												
0 1 1	Reserved.												
1 0 0	Reserved.												
1 0 1	Reserved.												
1 1 0	Reserved.												
1 1 1	ED (at 54 MHz) input.												
	Reserved	0											
0x02	Mode Register 0	Reserved								0	Zero must be written to this bit.	0x20	
		HD interlace external VSYNC and HSYNC								0	Default.		

REGISTER MAP ACCESS

Table 18. Register 0x01 to Register 0x09 (Continued)

SR7 to SR0	Register	Bit Description	Bit Number ¹								Register Setting	Reset Value	
			7	6	5	4	3	2	1	0			
										1		If using HD HSYNC/VSYNC interlace mode, setting this bit to 1 is recommended (see the HD Interlace External HSYNC and VSYNC Considerations section for more information).	
		Test pattern black bar ⁴								0		Disabled.	
										1		Enabled.	
		Manual CSC matrix adjust						0				Disable manual CSC matrix adjust.	
								1				Enable manual CSC matrix adjust.	
		Sync on RGB					0					No sync.	
							1					Sync on all RGB outputs.	
		RGB/YPrPb output select			0							RGB component outputs.	
					1							YPrPb component outputs.	
		SD sync output enable		0								No sync output.	
				1								Output SD syncs on $\overline{\text{HSYNC}}$ and $\overline{\text{VSYNC}}$ pins.	
		ED/HD sync output enable	0									No sync output.	
			1									Output ED/HD syncs on $\overline{\text{HSYNC}}$ and $\overline{\text{VSYNC}}$ pins.	
0x03	ED/HD CSC Matrix 0									x	x	LSBs for GY.	0x03
0x04	ED/HD CSC Matrix 1									x	x	LSBs for RV. LSBs for BU. LSBs for GV. LSBs for GU.	0xF0
			x	x									
0x05	ED/HD CSC Matrix 2		x	x	x	x	x	x	x	x	x	Bits[9:2] for GY.	0x4E
0x06	ED/HD CSC Matrix 3		x	x	x	x	x	x	x	x	x	Bits[9:2] for GU.	0x0E
0x07	ED/HD CSC Matrix 4		x	x	x	x	x	x	x	x	x	Bits[9:2] for GV.	0x24
0x08	ED/HD CSC Matrix 5		x	x	x	x	x	x	x	x	x	Bits[9:2] for BU.	0x92
0x09	ED/HD CSC Matrix 6		x	x	x	x	x	x	x	x	x	Bits[9:2] for RV.	0x7C

¹ x = Logic 0 or Logic 1.

² ED = enhanced definition = 525p and 625p.

³ Available on the ADV7392/ADV7393 (40-pin devices) only.

⁴ Subaddress 0x31, Bit 2 must also be enabled (ED/HD). Subaddress 0x84, Bit 6 must also be enabled (SD).

Table 19. Register 0x0B to Register 0x17

SR7 to SR0	Register	Bit Description	Bit Number ¹								Register Setting	Reset Value	
			7	6	5	4	3	2	1	0			
0x0B	DAC 1, DAC 2, DAC 3 output levels	Positive gain to DAC output voltage	0	0	0	0	0	0	0	0	0	0%	0x00
0			0	0	0	0	0	0	1	+0.018%.			
0			0	0	0	0	0	1	0	+0.036%.			
...					
0			0	1	1	1	1	1	1	+7.382%.			
0			1	0	0	0	0	0	0	+7.5%.			
		Negative gain to DAC output voltage	1	1	0	0	0	0	0	0	-7.5%.		

REGISTER MAP ACCESS

Table 19. Register 0x0B to Register 0x17 (Continued)

SR7 to SR0	Register	Bit Description	Bit Number ¹								Register Setting	Reset Value	
			7	6	5	4	3	2	1	0			
			1	1	0	0	0	0	0	0	1	-7.382%.	
			1	0	0	0	0	0	0	1	0	-7.364%.	
			
			1	1	1	1	1	1	1	1	1	-0.018%.	
0x0D	DAC power mode	DAC 1 low power mode									0	DAC 1 low power disabled.	0x00
										1	DAC 1 low power enabled.		
		DAC 2 low power mode								0	DAC 2 low power disabled.		
										1	DAC 2 low power enabled.		
		DAC 3 low power mode							0	DAC 3 low power disabled.			
								1	DAC 3 low power enabled.				
		SD/ED oversample rate select					0	SD = 16×, ED = 8×.					
						1	SD = 8×, ED = 4×.						
		Reserved	0	0	0	0							
0x10	Cable detection	DAC 1 cable detect									0	Cable detected on DAC 1.	0x00
		Read only									1	DAC 1 unconnected.	
		DAC 2 cable detect									0	Cable detected on DAC 2.	
		Read only									1	DAC 2 unconnected.	
		Reserved						0	0				
		Unconnected DAC autopower-down					0						
						1					DAC autopower-down enable.		
		Reserved	0	0	0								
0x13	Pixel Port Readback A ²	P[7:0] readback (ADV7390/ADV7391) P[15:8] readback (ADV7392/ADV7393)	x	x	x	x	x	x	x	x	x	Read only.	0xXX
0x14	Pixel Port Readback B ²	P[7:0] readback (ADV7392/ADV7393)	x	x	x	x	x	x	x	x	x	Read only.	0xXX
0x16	Control port readback ²	Reserved							x	x	x	Read only.	0xXX
		VSYNC readback						x					
		HSYNC readback				x							
		SFL readback			x								
		Reserved	x	x									
0x17	Software reset	Reserved									0		0x00
		Software reset								0	1	Writing a 1 resets the device; this is a self-clearing bit.	
		Reserved.	0	0	0	0	0	0					

¹ x = Logic 0 or Logic 1.

² For correct operation, Subaddress 0x01[6:4] must equal the default value of 000.

Table 20. Register 0x30

SR7 to SR0	Register	Bit Description	Bit Number								Register Setting	Note	Reset Value	
			7	6	5	4	3	2	1	0				
0x30	ED/HD Mode Register 1	ED/HD output standard								0	0	EIA-770.2 output	EDHD	0x00
									0	1	EIA-770.1 output			
									1	0	Output levels for full input range			
									1	1	Reserved			

REGISTER MAP ACCESS

Table 20. Register 0x30 (Continued)

SR7 to SR0	Register	Bit Description	Bit Number								Register Setting	Note	Reset Value		
			7	6	5	4	3	2	1	0					
		ED/HD input synchronization format								0		External HSYNC, VSYNC and field inputs ¹			
										1		Embedded EAV/SAV codes			
		ED/HD standard ²	0	0	0	0	0	0				SMPTE 293M, ITU-BT.1358	525p at 59.94 Hz		
			0	0	0	1	0					BTA-1004, ITU-BT.1362	525p at 59.94 Hz		
			0	0	0	1	1					ITU-BT.1358	625p at 50 Hz		
			0	0	1	0	0					ITU-BT.1362	625p at 50 Hz		
			0	0	1	0	1					SMPTE 296M-1, SMPTE 274M-2	720p at 60 Hz/59.94 Hz		
			0	0	1	1	0					SMPTE 296M-3	720p at 50 Hz		
			0	0	1	1	1					SMPTE 296M-4, SMPTE 274M-5	720p at 30 Hz/29.97 Hz		
			0	1	0	0	0					SMPTE 296M-6	720p at 25 Hz		
			0	1	0	0	1					SMPTE 296M-7, SMPTE 296M-8	720p at 24 Hz/23.98 Hz		
			0	1	0	1	0					SMPTE 240M	1035i at 60 Hz/59.94 Hz		
			0	1	0	1	1					Reserved			
			0	1	1	0	0					Reserved			
			0	1	1	0	1					SMPTE 274M-4, SMPTE 274M-5	1080i at 30 Hz/29.97 Hz		
			0	1	1	1	0					SMPTE 274M-6	1080i at 25 Hz		
			0	1	1	1	1					SMPTE 274M-7, SMPTE 274M-8	1080p at 30 Hz/29.97 Hz		
			1	0	0	0	0					SMPTE 274M-9	1080p at 25 Hz		
			1	0	0	0	1					SMPTE 274M-10, SMPTE 274M-11	1080p at 24 Hz/23.98 Hz		
			1	0	0	1	0					ITU-R BT.709-5	1080Psf at 24 Hz		
			10011 to 11111										Reserved		

¹ Synchronization can be controlled with a combination of either HSYNC and VSYNC inputs or HSYNC and field inputs, depending on Subaddress 0x34, Bit 6.

² See the [HD Interface External HSYNC and VSYNC Considerations](#) section for more information.

Table 21. Register 0x31 to Register 0x33

SR7 to SR0	Register	Bit Description	Bit Number								Register Setting	Reset Value	
			7	6	5	4	3	2	1	0			
0x31	ED/HD Mode Register 2	ED/HD pixel data valid									0	Pixel data valid off.	0x00
											1	Pixel data valid on.	
	HD oversample rate select									0	4x.		
										1	2x.		
	ED/HD test pattern enable									0	HD test pattern off.		
										1	HD test pattern on.		
	ED/HD test pattern hatch/field									0	Hatch.		
									1	Field/frame.			
	ED/HD vertical blanking interval (VBI) open								0	Disabled.			
									1	Enabled.			
	ED/HD undershoot limiter								0	0	Disabled.		
									0	1	-11 IRE.		

REGISTER MAP ACCESS

Table 21. Register 0x31 to Register 0x33 (Continued)

SR7 to SR0	Register	Bit Description	Bit Number								Register Setting	Reset Value	
			7	6	5	4	3	2	1	0			
				1	0							-6 IRE.	
				1	1							-1.5 IRE.	
		ED/HD sharpness filter	0									Disabled.	
			1									Enabled.	
0x32	ED/HD Mode Register 3	ED/HD Y delay with respect to the falling edge of HSYNC							0	0	0	0 clock cycles.	0x00
									0	0	1	One clock cycle.	
									0	1	0	Two clock cycles.	
									0	1	1	Three clock cycles.	
									1	0	0	Four clock cycles.	
		ED/HD color delay with respect to the falling edge of HSYNC			0	0	0					0 clock cycles.	
					0	0	1					One clock cycle.	
					0	1	0					Two clock cycles.	
					0	1	1					Three clock cycles.	
					1	0	0					Four clock cycles.	
		ED/HD CGMS enable		0								Disabled.	
				1								Enabled.	
		ED/HD CGMS CRC enable	0									Disabled.	
			1									Enabled.	
0x33	ED/HD Mode Register 4	ED/HD Cr/Cb sequence									0	Cb after falling edge of HSYNC.	0x68
											1	Cr after falling edge of HSYNC.	
		Reserved								0		0 must be written to this bit.	
		ED/HD input format							0			8-bit input.	
									1			10-bit input ¹ .	
		Sinc compensation filter on DAC 1, DAC 2, DAC 3						0				Disabled.	
								1				Enabled.	
		Reserved				0						0 must be written to this bit.	
		ED/HD chroma SSAF filter			0							Disabled.	
					1							Enabled.	
		Reserved		1								1 must be written to this bit.	
		ED/HD double buffering	0									Disabled.	
			1									Enabled.	

¹ Available on the ADV7392/ADV7393 (40-pin devices) only.

Table 22. Register 0x34 to Register 0x38

SR7 to SR0	Register	Bit Description	Bit Number ¹								Register Setting	Reset Value	
			7	6	5	4	3	2	1	0			
0x34	ED/HD Mode Register 5	ED/HD timing reset									0	Internal ED/HD timing counters enabled.	0x48
											1	Resets the internal ED/HD timing counters.	
		ED/HD HSYNC control ²								0		HSYNC output control (see Table 55).	
		ED/HD VSYNC control ²						0				VSYNC output control (see Table 56).	
		Reserved					1						
		ED Macrovision® enable ³			0							ED Macrovision disabled.	
					1							ED Macrovision enabled.	
		Reserved			0							0 must be written to this bit.	

REGISTER MAP ACCESS

Table 22. Register 0x34 to Register 0x38 (Continued)

SR7 to SR0	Register	Bit Description	Bit Number ¹								Register Setting	Reset Value	
			7	6	5	4	3	2	1	0			
		ED/HD VSYNC input/field input		0 1								0 = Field input. 1 = VSYNC input.	
		ED/HD horizontal/vertical counter mode ⁴	0 1									Update field/line counter. Field/line counter free running.	
0x35	ED/HD Mode Register 6	Reserved									0		0x00
		Reserved								0			
		ED/HD sync on PrPb							0 1			Disabled. Enabled.	
		ED/HD color DAC swap					0 1					DAC 2 = Pb, DAC 3 = Pr. DAC 2 = Pr, DAC 3 = Pb.	
		ED/HD gamma correction curve select				0 1						Gamma Correction Curve A. Gamma Correction Curve B.	
		ED/HD gamma correction enable			0 1							Disabled. Enabled.	
		ED/HD adaptive filter mode		0 1								Mode A. Mode B.	
		ED/HD adaptive filter enable	0 1									Disabled. Enabled.	
0x36	ED/HD Y level ⁵	ED/HD Test Pattern Y level	x	x	x	x	x	x	x	x		Y level value.	0xA0
0x37	ED/HD Cr level ⁵	ED/HD Test Pattern Cr level	x	x	x	x	x	x	x	x		Cr level value.	0x80
0x38	ED/HD Cb level ⁵	ED/HD Test Pattern Cb level	x	x	x	x	x	x	x	x		Cb level value.	0x80

¹ x = Logic 0 or Logic 1.

² Used in conjunction with ED/HD sync output enable in Subaddress 0x02, Bit 7 = 1.

³ Applies to the ADV7390 and ADV7392 only.

⁴ When set to 0, the horizontal/vertical counters automatically wrap around at the end of the line/field/frame of the selected standard. When set to 1, the horizontal/vertical counters are free running and wrap around when external sync signals indicate to do so.

⁵ For use with ED/HD internal test patterns only (Subaddress 0x31, Bit 2 = 1).

Table 23. Register 0x39 to Register 0x43

SR7 to SR0	Register	Bit Description	Bit Number								Register Setting	Reset Value	
			7	6	5	4	3	2	1	0			
0x39	ED/HD Mode Register 7	Reserved					0	0	0	0	0		0x00
		ED/HD EIA/CEA-861B synchronization compliance				0 1						Disabled Enabled	
		Reserved	0	0									
0x3A	ED/HD Mode Register 8	INV_PHSYNC_POL									0 1	Disabled Enabled	0x00
		INV_PVSYNC_POL								0 1	Disabled Enabled		
		INV_PBLANK_POL						0 1			Disabled Enabled		
		Reserved	0	0	0	0	0						
0x40	ED/HD sharpness filter gain	ED/HD sharpness filter gain Value A						0 0 ...	0 0 ...	0 0 ...	0 1 ...	Gain A = 0 Gain A = +1 ...	0x00

REGISTER MAP ACCESS

Table 23. Register 0x39 to Register 0x43 (Continued)

SR7 to SR0	Register	Bit Description	Bit Number								Register Setting	Reset Value
			7	6	5	4	3	2	1	0		
							0	1	1	1	Gain A = +7	
							1	0	0	0	Gain A = -8	
							
							1	1	...	1	Gain A = -1	
		ED/HD sharpness filter gain Value B	0	0	0	0					Gain B = 0	
			0	0	0	1					Gain B = +1	
			
			0	1	1	1					Gain B = +7	
			1	0	0	0					Gain B = -8	
			
			1	1	1	1					Gain B = -1	
0x41	ED/HD CGMS Data 0	ED/HD CGMS data bits	0	0	0	0	C19	C18	C17	C16	CGMS C19 to C16	0x00
0x42	ED/HD CGMS Data 1	ED/HD CGMS data bits	C15	C14	C13	C12	C11	C10	C9	C8	CGMS C15 to C8	0x00
0x43	ED/HD CGMS Data 2	ED/HD CGMS data bits	C7	C6	C5	C4	C3	C2	C1	C0	CGMS C7 to C0	0x00

Table 24. Register 0x44 to Register 0x57

SR7 to SR0	Register	Bit Descriptoin	Bit Number ¹								Register Setting	Reset Value
			7	6	5	4	3	2	1	0		
0x44	ED/HD Gamma A0	ED/HD Gamma Curve A (Point 24)	x	x	x	x	x	x	x	x	A0	0x00
0x45	ED/HD Gamma A1	ED/HD Gamma Curve A (Point 32)	x	x	x	x	x	x	x	x	A1	0x00
0x46	ED/HD Gamma A2	ED/HD Gamma Curve A (Point 48)	x	x	x	x	x	x	x	x	A2	0x00
0x47	ED/HD Gamma A3	ED/HD Gamma Curve A (Point 64)	x	x	x	x	x	x	x	x	A3	0x00
0x48	ED/HD Gamma A4	ED/HD Gamma Curve A (Point 80)	x	x	x	x	x	x	x	x	A4	0x00
0x49	ED/HD Gamma A5	ED/HD Gamma Curve A (Point 96)	x	x	x	x	x	x	x	x	A5	0x00
0x4A	ED/HD Gamma A6	ED/HD Gamma Curve A (Point 128)	x	x	x	x	x	x	x	x	A6	0x00
0x4B	ED/HD Gamma A7	ED/HD Gamma Curve A (Point 160)	x	x	x	x	x	x	x	x	A7	0x00
0x4C	ED/HD Gamma A8	ED/HD Gamma Curve A (Point 192)	x	x	x	x	x	x	x	x	A8	0x00
0x4D	ED/HD Gamma A9	ED/HD Gamma Curve A (Point 224)	x	x	x	x	x	x	x	x	A9	0x00
0x4E	ED/HD Gamma B0	ED/HD Gamma Curve B (Point 24)	x	x	x	x	x	x	x	x	B0	0x00
0x4F	ED/HD Gamma B1	ED/HD Gamma Curve B (Point 32)	x	x	x	x	x	x	x	x	B1	0x00
0x50	ED/HD Gamma B2	ED/HD Gamma Curve B (Point 48)	x	x	x	x	x	x	x	x	B2	0x00
0x51	ED/HD Gamma B3	ED/HD Gamma Curve B (Point 64)	x	x	x	x	x	x	x	x	B3	0x00
0x52	ED/HD Gamma B4	ED/HD Gamma Curve B (Point 80)	x	x	x	x	x	x	x	x	B4	0x00
0x53	ED/HD Gamma B5	ED/HD Gamma Curve B (Point 96)	x	x	x	x	x	x	x	x	B5	0x00
0x54	ED/HD Gamma B6	ED/HD Gamma Curve B (Point 128)	x	x	x	x	x	x	x	x	B6	0x00
0x55	ED/HD Gamma B7	ED/HD Gamma Curve B (Point 160)	x	x	x	x	x	x	x	x	B7	0x00
0x56	ED/HD Gamma B8	ED/HD Gamma Curve B (Point 192)	x	x	x	x	x	x	x	x	B8	0x00
0x57	ED/HD Gamma B9	ED/HD Gamma Curve B (Point 224)	x	x	x	x	x	x	x	x	B9	0x00

¹ x = Logic 0 or Logic 1.

REGISTER MAP ACCESS

Table 25. Register 0x58 to Register 0x5D

SR7 to SR0	Register	Bit Description	Bit Number ¹								Register Setting	Reset Value
			7	6	5	4	3	2	1	0		
0x58	ED/HD Adaptive Filter Gain 1	ED/HD Adaptive Filter Gain 1, Value A					0	0	0	0	Gain A = 0	0x00
						0	0	0	1	Gain A = +1		
							
						0	1	1	1	Gain A = +7		
						1	0	0	0	Gain A = -8		
							
						1	1	1	1	Gain A = -1		
		ED/HD Adaptive Filter Gain 1, Value B	0	0	0	0				Gain B = 0		
			0	0	0	1				Gain B = +1		
				
			0	1	1	1				Gain B = +7		
			1	0	0	0				Gain B = -8		
				
			1	1	1	1				Gain B = -1		
0x59	ED/HD Adaptive Filter Gain 2	ED/HD Adaptive Filter Gain 2, Value A					0	0	0	0	Gain A = 0	0x00
						0	0	0	1	Gain A = +1		
							
						0	1	1	1	Gain A = +7		
						1	0	0	0	Gain A = -8		
							
						1	1	1	1	Gain A = -1		
		ED/HD Adaptive Filter Gain 2, Value B	0	0	0	0				Gain B = 0		
			0	0	0	1				Gain B = +1		
				
			0	1	1	1				Gain B = +7		
			1	0	0	0				Gain B = -8		
				
			1	1	1	1				Gain B = -1		
0x5A	ED/HD Adaptive Filter Gain 3	ED/HD Adaptive Filter Gain 3, Value A					0	0	0	0	Gain A = 0	0x00
						0	0	0	1	Gain A = +1		
							
						0	1	1	1	Gain A = +7		
						1	0	0	0	Gain A = -8		
							
						1	1	1	1	Gain A = -1		
		ED/HD Adaptive Filter Gain 3, Value B	0	0	0	0				Gain B = 0		
			0	0	0	1				Gain B = +1		
				
			0	1	1	1				Gain B = +7		
			1	0	0	0				Gain B = -8		
				
			1	1	1	1				Gain B = -1		
0x5B	ED/HD Adaptive Filter Threshold A	ED/HD Adaptive Filter Threshold A	x	x	x	x	x	x	x	x	Threshold A	0x00
0x5C	ED/HD Adaptive Filter Threshold B	ED/HD Adaptive Filter Threshold B	x	x	x	x	x	x	x	x	Threshold B	0x00
0x5D	ED/HD Adaptive Filter Threshold C	ED/HD Adaptive Filter Threshold C	x	x	x	x	x	x	x	x	Threshold C	0x00

REGISTER MAP ACCESS

¹ x = Logic 0 or Logic 1.

Table 26. Register 0x5E to Register 0x6E

SR7 to SR0	Register	Bit Description	Bit Number								Register Setting	Reset Value	
			7	6	5	4	3	2	1	0			
0x5E	ED/HD CGMS Type B Register 0	ED/HD CGMS Type B enable									0 1	Disabled Enabled	0x00
		ED/HD CGMS Type B CRC enable									0 1	Disabled Enabled	
		ED/HD CGMS Type B header bits	H5	H4	H3	H2	H1	H0				H5 to H0	
0x5F	ED/HD CGMS Type B Register 1	ED/HD CGMS Type B data bits	P7	P6	P5	P4	P3	P2	P1	P0	P7 to P0	0x00	
0x60	ED/HD CGMS Type B Register 2	ED/HD CGMS Type B data bits	P15	P14	P13	P12	P11	P10	P9	P8	P15 to P8	0x00	
0x61	ED/HD CGMS Type B Register 3	ED/HD CGMS Type B data bits	P23	P22	P21	P20	P19	P18	P17	P16	P23 to P16	0x00	
0x62	ED/HD CGMS Type B Register 4	ED/HD CGMS Type B data bits	P31	P30	P29	P28	P27	P26	P25	P24	P31 to P24	0x00	
0x63	ED/HD CGMS Type B Register 5	ED/HD CGMS Type B data bits	P39	P38	P37	P36	P35	P34	P33	P32	P39 to P32	0x00	
0x64	ED/HD CGMS Type B Register 6	ED/HD CGMS Type B data bits	P47	P46	P45	P44	P43	P42	P41	P40	P47 to P40	0x00	
0x65	ED/HD CGMS Type B Register 7	ED/HD CGMS Type B data bits	P55	P54	P53	P52	P51	P50	P49	P48	P55 to P48	0x00	
0x66	ED/HD CGMS Type B Register 8	ED/HD CGMS Type B data bits	P63	P62	P61	P60	P59	P58	P57	P56	P63 to P56	0x00	
0x67	ED/HD CGMS Type B Register 9	ED/HD CGMS Type B data bits	P71	P70	P69	P68	P67	P66	P65	P64	P71 to P64	0x00	
0x68	ED/HD CGMS Type B Register 10	ED/HD CGMS Type B data bits	P79	P78	P77	P76	P75	P74	P73	P72	P79 to P72	0x00	
0x69	ED/HD CGMS Type B Register 11	ED/HD CGMS Type B data bits	P87	P86	P85	P84	P83	P82	P81	P80	P87 to P80	0x00	
0x6A	ED/HD CGMS Type B Register 12	ED/HD CGMS Type B data bits	P95	P94	P93	P92	P91	P90	P89	P88	P95 to P88	0x00	
0x6B	ED/HD CGMS Type B Register 13	ED/HD CGMS Type B data bits	P103	P102	P101	P100	P99	P98	P97	P96	P103 to P96	0x00	
0x6C	ED/HD CGMS Type B Register 14	ED/HD CGMS Type B data bits	P111	P110	P109	P108	P107	P106	P105	P104	P111 to P104	0x00	
0x6D	ED/HD CGMS Type B Register 15	ED/HD CGMS Type B data bits	P119	P118	P117	P116	P115	P114	P113	P112	P119 to P112	0x00	
0x6E	ED/HD CGMS Type B Register 16	ED/HD CGMS Type B data bits	P127	P126	P125	P124	P123	P122	P121	P120	P127 to P120	0x00	

Table 27. Register 0x80 to Register 0x83

SR7 to SR0	Register	Bit Description	Bit Number								Register Setting	Reset Value	
			7	6	5	4	3	2	1	0			
0x80	SD Mode Register 1	SD standard								0 0 1 1	0 1 0 1	NTSC PAL B, PAL D, PAL G, PAL H, PAL I PAL M PAL N	0x10
		SD luma filter				0	0	0				LPF NTSC	

REGISTER MAP ACCESS

Table 27. Register 0x80 to Register 0x83 (Continued)

SR7 to SR0	Register	Bit Description	Bit Number								Register Setting	Reset Value
			7	6	5	4	3	2	1	0		
						0	0	1			LPF PAL	
						0	1	0			Notch NTSC	
						0	1	1			Notch PAL	
						1	0	0			Luma SSAF	
						1	0	1			Luma CIF	
						1	1	0			Luma QCIF	
						1	1	1			Reserved	
		SD chroma filter	0	0	0						1.3 MHz	
			0	0	1						0.65 MHz	
			0	1	0						1.0 MHz	
			0	1	1						2.0 MHz	
			1	0	0						Reserved	
			1	0	1						Chroma CIF	
			1	1	0						Chroma QCIF	
			1	1	1						3.0 MHz	
0x82	SD Mode Register 2	SD PrPb SSAF filter								0	Disabled	0x0B
										1	Enabled	
		SD DAC Output 1								0	See Table 37	
										1		
		Reserved							0			
		SD pedestal						0			Disabled	
								1			Enabled	
		SD square pixel mode				0					Disabled	
						1					Enabled	
		SD VCR FF/RW sync			0						Disabled	
					1						Enabled	
		SD pixel data valid		0							Disabled	
				1							Enabled	
		SD active video edge control	0								Disabled	
			1								Enabled	
0x83	SD Mode Register 3	SD pedestal YPrPb output								0	No pedestal on YPrPb	0x04
										1	7.5 IRE pedestal on YPrPb	
		SD Output Levels Y								0	Y = 700 mV/300 mV	
										1	Y = 714 mV/286 mV	
		SD Output Levels PrPb					0	0			700 mV p-p (PAL), 1000 mV p-p (NTSC)	
							0	1			700 mV p-p	
							1	0			1000 mV p-p	
							1	1			648 mV p-p	
		SD vertical blanking interval (VBI) open				0					Disabled	
						1					Enabled	
		SD closed captioning field control		0	0						Closed captioning disabled	
				0	1						Closed captioning on odd field only	
				1	0						Closed captioning on even field only	
				1	1						Closed captioning on both fields	
		Reserved	0								Reserved	

REGISTER MAP ACCESS

Table 28. Register 0x84 to Register 0x87

SR7 to SR0	Register	Bit Description	Bit Number								Register Setting	Reset Value
			7	6	5	4	3	2	1	0		
0x84	SD Mode Register 4	Reserved									0	0x00
		SD SFL/SCR/TR mode select						0	0	Disabled.		
								1	1	SFL mode enabled.		
		SD active video length					0			720 pixels.		
							1			710 (NTSC), 702 (PAL).		
		SD chroma				0				Chroma enabled.		
						1				Chroma disabled.		
SD burst			0					Enabled.				
			1					Disabled.				
SD color bars		0						Disabled.				
		1						Enabled.				
SD luma/chroma swap		0						DAC 2 = luma, DAC 3 = chroma.				
		1						DAC 2 = chroma, DAC 3 = luma.				
0x86	SD Mode Register 5	NTSC color subcarrier adjust (delay from the falling edge of output HSYNC pulse to the start of color burst)						0	0	5.17 μ s.	0x02	
								0	1	5.31 μ s.		
								1	0	5.59 μ s (must be set for Macrovision compliance).		
								1	1	Reserved.		
		Reserved						0				
		SD EIA/CEA-861B synchronization compliance					0			Disabled.		
					1			Enabled.				
Reserved			0	0								
SD horizontal/vertical counter mode ¹		0						Update field/line counter.				
		1						Field/line counter free running.				
SD RGB color swap ²		0						Normal.				
		1						Color reversal enabled.				
0x87	SD Mode Register 6	SD luma and color scale control							0	Disabled.	0x00	
									1	Enabled.		
		SD luma scale saturation							0	Disabled.		
									1	Enabled.		
		SD hue adjust						0		Disabled.		
								1		Enabled.		
		SD brightness					0			Disabled.		
							1			Enabled.		
SD luma SSAF gain				0				Disabled.				
				1				Enabled.				
SD input standard autodetection			0					Disabled.				
			1					Enabled.				
Reserved		0						0 must be written to this bit.				
SD RGB input enable ²		0						SD YCrCb input.				
		1						SD RGB input.				

¹ When set to 0, the horizontal/vertical counters automatically wrap around at the end of the line/field/frame of the selected standard. When set to 1, the horizontal/vertical counters are free running and wrap around when external sync signals indicate to do so.

² Available on the ADV7392/ADV7393 (40-pin devices) only.

REGISTER MAP ACCESS

Table 29. Register 0x88 to Register 0x89

SR7 to SR0	Register	Bit Description	Bit Number								Register Setting	Reset Value		
			7	6	5	4	3	2	1	0				
0x88	SD Mode Register 7	Reserved									0	0x00		
		SD noninterlaced mode								0	1		Disabled. Enabled.	
		SD double buffering							0	1	Disabled. Enabled.			
		SD input format				0	0						8-bit YCbCr input. 16-bit YCbCr input. ¹ 10-bit YCbCr/16-bit SD RGB input. ¹ Reserved.	
		SD digital noise reduction			0	1							Disabled. Enabled.	
		SD gamma correction enable		0	1								Disabled. Enabled.	
		SD gamma correction curve select	0	1									Gamma Correction Curve A. Gamma Correction Curve B.	
0x89	SD Mode Register 8	SD undershoot limiter							0	0	0	1	0x00	
									1	0	1	1		Disabled. -11 IRE. -6 IRE. -1.5 IRE.
		Reserved						0						0 must be written to this bit.
		Reserved					0							Reserved.
		SD chroma delay			0	0	0	1						Disabled. 4 clock cycles. 8 clock cycles. Reserved.
		Reserved	0	0										0 must be written to these bits.

¹ Available on the ADV7392/ADV7393 (40-pin devices) only.

Table 30. Register 0x8A to Register 0x98

SR7 to SR0	Register	Bit Description	Bit Number ¹								Register Setting	Reset Value			
			7	6	5	4	3	2	1	0					
0x8A	SD Timing Register 0	SD subordinate/main mode									0	1	0x08		
														Subordinate mode. Main mode.	
		SD timing mode							0	0	0	1		1	Mode 0. Mode 1. Mode 2. Mode 3.
		Reserved						1							
		SD luma delay			0	0	0	1							No delay. Two clock cycles. Four clock cycles. Six clock cycles.
		SD minimum luma value		0	1										-40 IRE. -7.5 IRE.

REGISTER MAP ACCESS

Table 30. Register 0x8A to Register 0x98 (Continued)

SR7 to SR0	Register	Bit Description	Bit Number ¹								Register Setting	Reset Value	
			7	6	5	4	3	2	1	0			
		SD timing reset	x									A low-high-low transition resets the internal SD timing counters.	
0x8B	SD Timing Register 1 Note: Applicable in main modes only, that is, Subaddress 0x8A, Bit 0 = 1.	SD HSYNC width								0	0	t_a = one clock cycle.	0x00
									0	1	t_a = four clock cycles.		
									1	0	t_a = 16 clock cycles.		
									1	1	t_a = 128 clock cycles.		
		SD HSYNC to VSYNC delay					0	0				t_b = 0 clock cycles.	
					0	1				t_b = four clock cycles.			
					1	0				t_b = eight clock cycles.			
					1	1					t_b = 18 clock cycles.		
		SD HSYNC to VSYNC rising edge delay (Mode 1 only)			X ²	0						t_c = t_b .	
					X ²	1						t_c = t_b + 32 μ s.	
		SD VSYNC width (Mode 2 only)			0	0						One clock cycle.	
					0	1						Four clock cycles.	
					1	0						16 clock cycles.	
					1	1						128 clock cycles.	
		SD HSYNC to pixel data adjust	0	0								0 clock cycles.	
			0	1								One clock cycle.	
			1	0								Two clock cycles.	
			1	1								Three clock cycles.	
0x8C	SD F _{SC} Register 0 ³	Subcarrier Frequency Bits[7:0]	x	x	x	x	x	x	x	x	x	Subcarrier Frequency Bits[7:0].	0x1F
0x8D	SD F _{SC} Register 1 ³	Subcarrier Frequency Bits[15:8]	x	x	x	x	x	x	x	x	x	Subcarrier Frequency Bits[15:8].	0x7C
0x8E	SD F _{SC} Register 2 ³	Subcarrier Frequency Bits[23:16]	x	x	x	x	x	x	x	x	x	Subcarrier Frequency Bits[23:16].	0xF0
0x8F	SD F _{SC} Register 3 ³	Subcarrier Frequency Bits[31:24]	x	x	x	x	x	x	x	x	x	Subcarrier Frequency Bits[31:24].	0x21
0x90	SD F _{SC} Phase	Subcarrier Phase Bits[9:2]	x	x	x	x	x	x	x	x	x	Subcarrier Phase Bits[9:2].	0x00
0x91	SD Closed Captioning	Extended data on even fields	x	x	x	x	x	x	x	x	x	Extended Data Bits[7:0].	0x00
0x92	SD Closed Captioning	Extended data on even fields	x	x	x	x	x	x	x	x	x	Extended Data Bits[15:8].	0x00
0x93	SD Closed Captioning	Data on odd fields	x	x	x	x	x	x	x	x	x	Data Bits[7:0].	0x00
0x94	SD Closed Captioning	Data on odd fields	x	x	x	x	x	x	x	x	x	Data Bits[15:8].	0x00
0x95	SD Pedestal Register 0	Pedestal on odd fields	17	16	15	14	13	12	11	10		Setting any of these bits to 1 disables the pedestal on the line number indicated by the bit settings.	0x00
0x96	SD Pedestal Register 1	Pedestal on odd fields	25	24	23	22	21	20	19	18			0x00
0x97	SD Pedestal Register 2	Pedestal on even fields	17	16	15	14	13	12	11	10			0x00
0x98	SD Pedestal Register 3	Pedestal on even fields	25	24	23	22	21	20	19	18			0x00

¹ x = Logic 0 or Logic 1.² X = don't care.³ SD subcarrier frequency registers default to NTSC subcarrier frequency values.

REGISTER MAP ACCESS

Table 31. Register 0x99 to Register 0xA5

SR7 to SR0	Register	Bit Description	Bit Number ¹								Register Setting	Reset Value
			7	6	5	4	3	2	1	0		
0x99	SD CGMS/WSS 0	SD CGMS data					x	x	x	x	CGMS Data Bits[C19:C16]	0x00
		SD CGMS CRC				0 1					Disabled Enabled	
		SD CGMS on odd fields			0 1						Disabled Enabled	
		SD CGMS on even fields		0 1							Disabled Enabled	
		SD WSS	0 1								Disabled Enabled	
0x9A	SD CGMS/WSS 1	SD CGMS/WSS data			x	x	x	x	x	x	CGMS Data Bits[C13:C8] or WSS Data Bits[W13:W8]	0x00
		SD CGMS data	x	x							CGMS Data Bits[C15:C14]	
0x9B	SD CGMS/WSS 2	SD CGMS/WSS data	x	x	x	x	x	x	x	x	CGMS Data Bits[C7:C0] or WSS Data Bits[W7:W0]	0x00
0x9C	SD scale LSB	LSBs for SD Y scale value							x	x	SD Y Scale Bits[1:0]	0x00
		LSBs for SD Cb scale value					x	x			SD Cb Scale Bits[1:0]	
		LSBs for SD Cr scale value			x	x					SD Cr Scale Bits[1:0]	
		LSBs for SD F _{SC} phase	x	x							Subcarrier Phase Bits[1:0]	
0x9D	SD Y scale	SD Y scale value	x	x	x	x	x	x	x	x	SD Y Scale Bits[9:2]	0x00
0x9E	SD Cb scale	SD Cb scale value	x	x	x	x	x	x	x	x	SD Cb Scale Bits[9:2]	0x00
0x9F	SD Cr scale	SD Cr scale value	x	x	x	x	x	x	x	x	SD Cr Scale Bits[9:2]	0x00
0xA0	SD hue adjust	SD hue adjust value	x	x	x	x	x	x	x	x	SD Hue Adjust Bits[7:0]	0x00
0xA1	SD brightness/WSS	SD brightness value		x	x	x	x	x	x	x	SD Brightness Bits[6:0]	0x00
		SD blank WSS data	0 1								Disabled Enabled	
0xA2	SD luma SSAF	SD luma SSAF gain/attenuation (only applicable if Subaddress 0x87, Bit 4 = 1)					0	0	0	0	-4 dB	0x00
							
						0	1	1	0	0 dB		
							
						1	1	0	0	+4 dB		
Reserved	0	0	0	0								
0xA3	SD DNR 0	Coring gain border (in DNR mode, the values in brackets apply)					0	0	0	0	No gain	0x00
							0	0	0	1	+1/16 [-1/8]	
							0	0	1	0	+2/16 [-2/8]	
							0	0	1	1	+3/16 [-3/8]	
							0	1	0	0	+4/16 [-4/8]	
							0	1	0	1	+5/16 [-5/8]	
							0	1	1	0	+6/16 [-6/8]	
							0	1	1	1	+7/16 [-7/8]	
							1	0	0	0	+8/16 [-1]	
		Coring gain data (in DNR mode, the values in brackets apply)	0	0	0	0					No gain	
			0	0	0	1					+1/16 [-1/8]	
			0	0	1	0					+2/16 [-2/8]	
			0	0	1	1					+3/16 [-3/8]	
0	1		0	0					+4/16 [-4/8]			
0	1		0	1					+5/16 [-5/8]			
0	1	1	0					+6/16 [-6/8]				

REGISTER MAP ACCESS

Table 31. Register 0x99 to Register 0xA5 (Continued)

SR7 to SR0	Register	Bit Description	Bit Number ¹								Register Setting	Reset Value	
			7	6	5	4	3	2	1	0			
			0	1	1	1						+7/16 [-7/8]	
			1	0	0	0						+8/16 [-1]	
0xA4	SD DNR 1	DNR threshold			0	0	0	0	0	0	0	0	0x00
					0	0	0	0	0	0	1	1	
					
					1	1	1	1	1	1	0	62	
					1	1	1	1	1	1	1	63	
		Border area		0								Two pixels	
				1								Four pixels	
		Block size	0									Eight pixels	
			1									16 pixels	
0xA5	SD DNR 2	DNR input select						0	0	1	Filter A	0x00	
								0	1	0	Filter B		
								0	1	1	Filter C		
								1	0	0	Filter D		
		DNR mode					0				DNR mode		
							1				DNR sharpness mode		
		DNR block offset	0	0	0	0					0 pixel offset		
			0	0	0	1					One pixel offset		
				
			1	1	1	0					14 pixel offset		
			1	1	1	1					15 pixel offset		

¹ x = Logic 0 or Logic 1.

Table 32. Register 0xA6 to Register 0xBB

SR7 to SR0	Register	Bit Description	Bit Number ¹								Register Setting	Reset Value
			7	6	5	4	3	2	1	0		
0xA6	SD Gamma A0	SD Gamma Curve A (Point 24)	x	x	x	x	x	x	x	x	A0	0x00
0xA7	SD Gamma A1	SD Gamma Curve A (Point 32)	x	x	x	x	x	x	x	x	A1	0x00
0xA8	SD Gamma A2	SD Gamma Curve A (Point 48)	x	x	x	x	x	x	x	x	A2	0x00
0xA9	SD Gamma A3	SD Gamma Curve A (Point 64)	x	x	x	x	x	x	x	x	A3	0x00
0xAA	SD Gamma A4	SD Gamma Curve A (Point 80)	x	x	x	x	x	x	x	x	A4	0x00
0xAB	SD Gamma A5	SD Gamma Curve A (Point 96)	x	x	x	x	x	x	x	x	A5	0x00
0xAC	SD Gamma A6	SD Gamma Curve A (Point 128)	x	x	x	x	x	x	x	x	A6	0x00
0xAD	SD Gamma A7	SD Gamma Curve A (Point 160)	x	x	x	x	x	x	x	x	A7	0x00
0xAE	SD Gamma A8	SD Gamma Curve A (Point 192)	x	x	x	x	x	x	x	x	A8	0x00
0xAF	SD Gamma A9	SD Gamma Curve A (Point 224)	x	x	x	x	x	x	x	x	A9	0x00
0xB0	SD Gamma B0	SD Gamma Curve B (Point 24)	x	x	x	x	x	x	x	x	B0	0x00
0xB1	SD Gamma B1	SD Gamma Curve B (Point 32)	x	x	x	x	x	x	x	x	B1	0x00
0xB2	SD Gamma B2	SD Gamma Curve B (Point 48)	x	x	x	x	x	x	x	x	B2	0x00
0xB3	SD Gamma B3	SD Gamma Curve B (Point 64)	x	x	x	x	x	x	x	x	B3	0x00
0xB4	SD Gamma B4	SD Gamma Curve B (Point 80)	x	x	x	x	x	x	x	x	B4	0x00
0xB5	SD Gamma B5	SD Gamma Curve B (Point 96)	x	x	x	x	x	x	x	x	B5	0x00
0xB6	SD Gamma B6	SD Gamma Curve B (Point 128)	x	x	x	x	x	x	x	x	B6	0x00
0xB7	SD Gamma B7	SD Gamma Curve B (Point 160)	x	x	x	x	x	x	x	x	B7	0x00
0xB8	SD Gamma B8	SD Gamma Curve B (Point 192)	x	x	x	x	x	x	x	x	B8	0x00

REGISTER MAP ACCESS

Table 32. Register 0xA6 to Register 0xBB (Continued)

SR7 to SR0	Register	Bit Description	Bit Number ¹								Register Setting	Reset Value	
			7	6	5	4	3	2	1	0			
0xB9	SD Gamma B9	SD Gamma Curve B (Point 224)	x	x	x	x	x	x	x	x	x	B9	0x00
0xBA	SD brightness detect	SD brightness value	x	x	x	x	x	x	x	x	x	Read only	0xFF
0xBB	Field count	Field count							x	x	x	Read only	0x0X
		Reserved			0	0	0					Reserved	
		Encoder version code	0	0								Read only; first encoder version ²	
			0	1								Read only; second encoder version	

¹ x = Logic 0 or Logic 1.

² See the [HD Interface External HSYNC and VSYNC Considerations](#) section for information about the first encoder version.

Table 33. Register 0xC9 to Register 0xCE

SR7 to SR0	Register	Bit Description	Bit Number								Register Setting	Reset Value	
			7	6	5	4	3	2	1	0			
0xC9	Teletext control	Teletext enable									0 1	Disabled. Enabled.	0x00
		Teletext request mode								0 1	Line request signal. Bit request signal.		
		Teletext input pin select ¹						0 1			VSYNC. P0.		
		Reserved	0	0	0	0	0				Reserved.		
0xCA	Teletext request control	Teletext request falling edge position control					0 0 ... 1 1	0 0 ... 1 1	0 0 ... 1 1	0 1 ... 0 1	0 clock cycles. One clock cycle. ... 14 clock cycles. 15 clock cycles.	0x00	
		Teletext request rising edge position control	0 0 ... 1 1	0 0 ... 1 1	0 0 ... 1 1	0 1 ... 0 1				0 clock cycles. One clock cycle. ... 14 clock cycles. 15 clock cycles.			
		TTX Line Enable 0	22	21	20	19	18	17	16	15	Setting any of these bits to 1 enables teletext on the line number indicated by the bit settings.		
		TTX Line Enable 1	14	13	12	11	10	9	8	7			
		TTX Line Enable 2	22	21	20	19	18	17	16	15			
		TTX Line Enable 3	14	13	12	11	10	9	8	7			

¹ The use of P0 as the teletext input pin is available on the ADV7392/ADV7393 (40-pin devices) only.

Table 34. Register 0xE0 to Register 0xF1

SR7 to SR0	Register ¹	Bit Description	Bit Number ²								Register Setting	Reset Value
			7	6	5	4	3	2	1	0		
0xE0	Macrovision	MV control bits	x	x	x	x	x	x	x	x		0x00
0xE1	Macrovision	MV control bits	x	x	x	x	x	x	x	x		0x00
0xE2	Macrovision	MV control bits	x	x	x	x	x	x	x	x		0x00
0xE3	Macrovision	MV control bits	x	x	x	x	x	x	x	x		0x00
0xE4	Macrovision	MV control bits	x	x	x	x	x	x	x	x		0x00

REGISTER MAP ACCESS

Table 34. Register 0xE0 to Register 0xF1 (Continued)

SR7 to SR0	Register ¹	Bit Description	Bit Number ²								Register Setting	Reset Value
			7	6	5	4	3	2	1	0		
0xE5	Macrovision	MV control bits	x	x	x	x	x	x	x	x		0x00
0xE6	Macrovision	MV control bits	x	x	x	x	x	x	x	x		0x00
0xE7	Macrovision	MV control bits	x	x	x	x	x	x	x	x		0x00
0xE8	Macrovision	MV control bits	x	x	x	x	x	x	x	x		0x00
0xE9	Macrovision	MV control bits	x	x	x	x	x	x	x	x		0x00
0xEA	Macrovision	MV control bits	x	x	x	x	x	x	x	x		0x00
0xEB	Macrovision	MV control bits	x	x	x	x	x	x	x	x		0x00
0xEC	Macrovision	MV control bits	x	x	x	x	x	x	x	x		0x00
0xED	Macrovision	MV control bits	x	x	x	x	x	x	x	x		0x00
0xEE	Macrovision	MV control bits	x	x	x	x	x	x	x	x		0x00
0xEF	Macrovision	MV control bits	x	x	x	x	x	x	x	x		0x00
0xF0	Macrovision	MV control bits	x	x	x	x	x	x	x	x		0x00
0xF1	Macrovision	MV control bits	0	0	0	0	0	0	0	x	Bits[7:1] must be 0.	0x00

¹ Macrovision registers are available on the ADV7390 and the ADV7392 only.

² x = Logic 0 or Logic 1.

ADV7390/ADV7391 INPUT CONFIGURATION

The ADV7390/ADV7391 support a number of different input modes. The desired input mode is selected using Subaddress 0x01, Bits[6:4]. The ADV7390/ADV7391 default to standard definition (SD) mode on power-up. Table 35 provides an overview of all possible input configurations. Each input mode is described in detail in this section. Note that the WLCSP option is only configured to support SD as shown in Figure 53.

Table 35. ADV7390/ADV7391 Input Configuration

Input Mode	P7	P6	P5	P4	P3	P2	P1	P0
000	SD				YCrCb			
010	ED/HD-DDR				YCrCb			
111	ED (at 54 MHz)				YCrCb			

STANDARD DEFINITION

Subaddress 0x01, Bits[6:4] = 000

SD YCrCb data can be input in an interleaved 4:2:2 format over an 8-bit bus rate of 27 MHz. A 27 MHz clock signal must be provided on the CLKIN pin. If required, external synchronization signals can be provided on the HSYNC and VSYNC pins.

Embedded EAV/SAV timing codes are also supported. The ITU-R BT.601/656 input standard is supported. The interleaved pixel data is input on Pin P7 to Pin P0, with Pin P0 being the LSB.

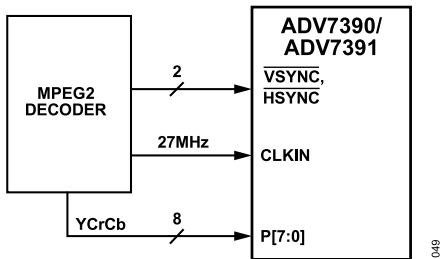

Figure 53. SD Example Application

ENHANCED DEFINITION/HIGH DEFINITION

Subaddress 0x01, Bits[6:4] = 010

Enhanced definition (ED) or high definition (HD) YCrCb data can be input in an interleaved 4:2:2 format over an 8-bit DDR bus. The clock signal must be provided on the CLKIN pin. If required, external synchronization signals can be provided on the HSYNC and VSYNC pins. Embedded EAV/SAV timing codes are also supported.

8-Bit 4:2:2 ED/HD YCrCb Mode (DDR)

In 8-bit DDR 4:2:2 YCrCb input mode, the Y pixel data is input on Pin P7 to Pin P0 on either the rising or falling edge of CLKIN. Pin P0 is the LSB.

The CrCb pixel data is also input on Pin P7 to Pin P0 on the opposite edge of CLKIN. Pin P0 is the LSB.

Whether the Y data is clocked in on the rising or falling edge of CLKIN is determined by Subaddress 0x01, Bits[2:1] (see Figure 54 and Figure 55).

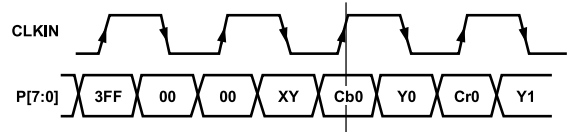

NOTES
1. SUBADDRESS 0x01 [2:1] SHOULD BE SET TO 00 IN THIS CASE.

Figure 54. ED/HD-DDR Input Sequence (EAV/SAV)—Option A

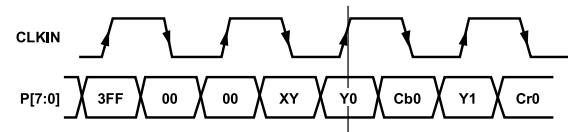

NOTES
1. SUBADDRESS 0x01 [2:1] SHOULD BE SET TO 11 IN THIS CASE.

Figure 55. ED/HD-DDR Input Sequence (EAV/SAV)—Option B

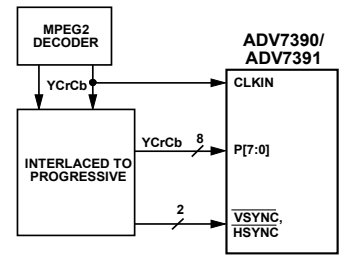

Figure 56. ED/HD-DDR Example Application

ENHANCED DEFINITION (AT 54 MHz)

Subaddress 0x01, Bits[6:4] = 111

ED YCrCb data can be input in an interleaved 4:2:2 format over an 8-bit bus rate of 54 MHz.

A 54 MHz clock signal must be provided on the CLKIN pin. Embedded EAV/SAV timing codes are supported. External synchronization signals are not supported in this mode.

The interleaved pixel data is input on Pin P7 to Pin P0, with Pin P0 being the LSB.

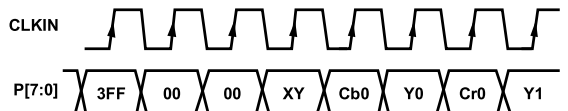

Figure 57. ED (at 54 MHz) Input Sequence (EAV/SAV)

ADV7392/ADV7393 INPUT CONFIGURATION

The ADV7392/ADV7393 support a number of different input modes. The desired input mode is selected using Subaddress 0x01, Bits[6:4]. The ADV7392/ADV7393 default to standard definition (SD) mode on power-up. Table 36 provides an overview of all possible input configurations. Each input mode is described in detail in this section.

STANDARD DEFINITION

Subaddress 0x01, Bits[6:4] = 000

Standard definition YCrCb data can be input in 4:2:2 format over an 8-, 10-, or 16-bit bus. SD RGB data can be input in 4:4:4 format over a 16-bit bus.

A 27 MHz clock signal must be provided on the CLKIN pin. If required, external synchronization signals can be provided on the HSYNC and VSYNC pins. Embedded EAV/SAV timing codes are also supported in 8-bit and 10-bit modes.

8-Bit 4:2:2 YCrCb Mode

Subaddress 0x87, Bit 7 = 0; Subaddress 0x88, Bits[4:3] = 00

In 8-bit 4:2:2 YCrCb input mode, the interleaved pixel data is input on Pin P15 to Pin P8, with Pin P8 being the LSB. The ITU-R BT.601/656 input standard is supported.

10-Bit 4:2:2 YCrCb Mode

Subaddress 0x87, Bit 7 = 0; Subaddress 0x88, Bits[4:3] = 10

In 10-bit 4:2:2 YCrCb input mode, the interleaved pixel data is input on Pin P15 to Pin P6, with Pin P6 being the LSB. The ITU-R BT.601/656 input standard is supported.

16-Bit 4:2:2 YCrCb Mode

Subaddress 0x87, Bit 7 = 0; Subaddress 0x88, Bits[4:3] = 01

In 16-bit 4:2:2 YCrCb input mode, the Y pixel data is input on Pin P15 to Pin P8, with Pin P8 being the LSB.

The CrCb pixel data is input on Pin P7 to Pin P0, with Pin P0 being the LSB.

The pixel data is updated at half the rate of the clock, that is, at a rate of 13.5 MHz (see Figure 5).

16-Bit 4:4:4 RGB Mode

Embedded EAV/SAV timing codes are not supported with SD RGB mode. Also, main timing mode is not supported for SD RGB input mode, therefore, external synchronization must be used.

Subaddress 0x87, Bit 7 = 1

In 16-bit 4:4:4 RGB input mode, the red pixel data is input on Pin P4 to Pin P0, the green pixel data is input on Pin P10 to Pin P5, and the blue pixel data is input on Pin P15 to Pin P11. The P0, P5, and P11 pins are the respective bus LSBs.

The pixel data is updated at half the rate of the clock, that is, at a rate of 13.5 MHz (see Figure 6).

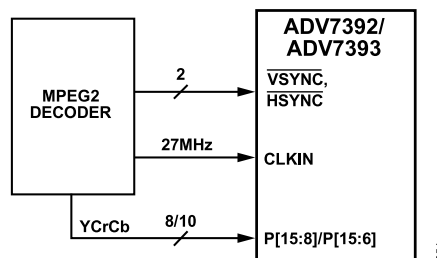

Figure 58. SD Example Application

Table 36. ADV7392/ADV7393 Input Configuration

Input Mode ¹		P15	P14	P13	P12	P11	P10	P9	P8	P7	P6	P5	P4	P3	P2	P1	P0	
000	SD ²	SD RGB input enable (0x87[7]) = 0																
	8-bit	YCrCb																
	10-bit	YCrCb																
	16-bit ³	Y																
		SD RGB input enable (0x87[7]) = 1																
	16-bit ³	B					G					R						
001	ED/HD-SDR (16-bit)	Y																
		CrCb																
010	ED/HD-DDR ⁴	ED/HD input format (0x33[2]) = 0																
	8-bit	YCrCb																
		ED/HD input format (0x33[2]) = 1																
	10-bit	YCrCb																
111	ED (at 54 MHz)	ED/HD input format (0x33[2]) = 0																

ADV7392/ADV7393 INPUT CONFIGURATION

Table 36. ADV7392/ADV7393 Input Configuration (Continued)

Input Mode ¹	P15	P14	P13	P12	P11	P10	P9	P8	P7	P6	P5	P4	P3	P2	P1	P0
8-bit	YCrCb								ED/HD input format (0x33[2]) = 1							
10-bit	YCrCb															

- ¹ The input mode is determined by Subaddress 0x01, Bits[6:4].
- ² In SD mode, the width of the input data is determined by Subaddress 0x88, Bits[4:3].
- ³ External synchronization signals must be used in this input mode. Embedded EAV/SAV timing codes are not supported.
- ⁴ ED = enhanced definition = 525p and 625p.

ENHANCED DEFINITION/HIGH DEFINITION

Subaddress 0x01, Bits[6:4] = 001 or 010

ED or HD YCrCb data can be input in a 4:2:2 format over an 8-/10-bit DDR bus or a 16-bit SDR bus.

The clock signal must be provided on the CLKIN pin. If required, external synchronization signals can be provided on the HSYNC and VSYNC pins. Embedded EAV/SAV timing codes are also supported.

16-Bit 4:2:2 YCrCb Mode (SDR)

In 16-bit 4:2:2 YCrCb input mode, the Y pixel data is input on Pin P15 to Pin P8, with P8 being the LSB.

The CrCb pixel data is input on Pin P7 to Pin P0, with Pin P0 being the LSB.

8-/10-Bit 4:2:2 YCrCb Mode (DDR)

In 8-/10-bit DDR 4:2:2 YCrCb input mode, the Y pixel data is input on Pin P15 to Pin P8/P6 on either the rising or falling edge of CLKIN. Pin P8/P6 is the LSB.

The CrCb pixel data is also input on Pin P15 to Pin P8/P6 on the opposite edge of CLKIN. P8/P6 is the LSB.

The 10-bit mode is enabled using Subaddress 0x33, Bit 2. Whether the Y data is clocked in on the rising or falling edge of CLKIN is determined by Subaddress 0x01, Bits[2:1] (see Figure 59 and Figure 60).

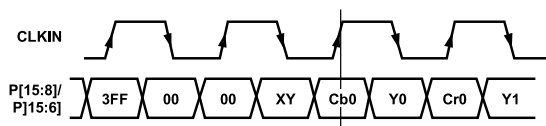

- NOTES
- 1. SUBADDRESS 0x01 [2:1] SHOULD BE SET TO 00 IN THIS CASE.
- 2. 10-BIT MODE IS ENABLED USING SUBADDRESS 0x33, BIT 2.

Figure 59. ED/HD-DDR Input Sequence (EAV/SAV)—Option A

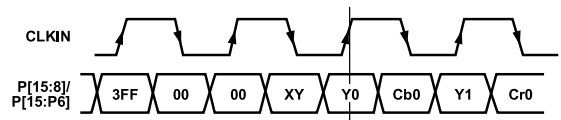

- NOTES
- 1. SUBADDRESS 0x01 [2:1] SHOULD BE SET TO 11 IN THIS CASE.
- 2. 10-BIT MODE IS ENABLED USING SUBADDRESS 0x33, BIT 2.

Figure 60. ED/HD-DDR Input Sequence (EAV/SAV)—Option B

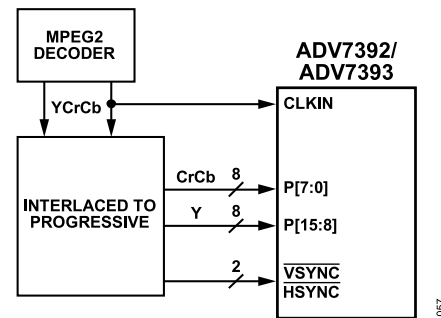

Figure 61. ED/HD-SDR Example Application

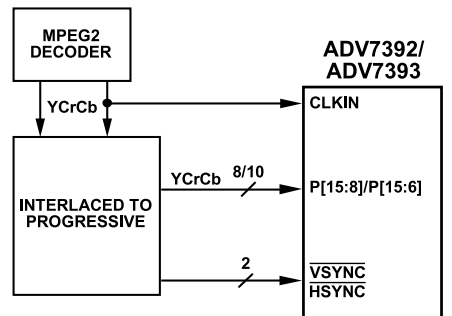

Figure 62. ED/HD-DDR Example Application

ADV7392/ADV7393 INPUT CONFIGURATION

ENHANCED DEFINITION (AT 54 MHZ)

Subaddress 0x01, Bits[6:4] = 111

ED YCrCb data can be input in an interleaved 4:2:2 format on an 8-/10-bit bus at a rate of 54 MHz.

A 54 MHz clock signal must be provided on the CLKIN pin. Embedded EAV/SAV timing codes are supported. External synchronization signals are not supported in this mode.

The interleaved pixel data is input on Pin P15 to Pin P8/P6, with Pin P8/P6 being the LSB.

The 10-bit mode is enabled using Subaddress 0x33, Bit 2.

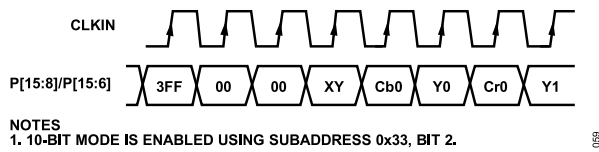

Figure 63. ED (at 54 MHz) Input Sequence (EAV/SAV)

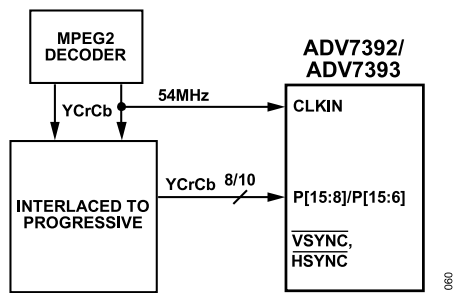

Figure 64. ED (at 54 MHz) Example Application

OUTPUT CONFIGURATION

The ADV7390/ADV7391/ADV7392/ADV7393 support a number of different output configurations. Table 37 to Table 39 list all possible output configurations.

Table 37. SD Output Configurations

RGB/YPrPb Output Select ¹ (Subaddress 0x02, Bit 5)	SD DAC Output 1 (Subaddress 0x82, Bit 1)	SD Luma/Chroma Swap (Subaddress 0x84, Bit 7)	DAC 1	DAC 2	DAC 3
0	0	0	G	B	R
1	0	0	Y	Pb	Pr
1	1	0	CVBS	Luma	Chroma
1	1	1	CVBS	Chroma	Luma

¹ If SD RGB output is selected, a color reversal is possible using Subaddress 0x86, Bit 7.

Table 38. ED/HD Output Configurations

RGB/YPrPb Output Select (Subaddress 0x02, Bit 5)	ED/HD Color DAC Swap (Subaddress 0x35, Bit 3)	DAC 1	DAC 2	DAC 3
0	0	G	B	R
0	1	G	R	B
1	0	Y	Pb	Pr
1	1	Y	Pr	Pb

Table 39. ED (at 54 MHz) Output Configurations

RGB/YPrPb Output Select (Subaddress 0x02, Bit 5)	ED/HD Color DAC Swap (Subaddress 0x35, Bit 3)	DAC 1	DAC 2	DAC 3
0	0	G	B	R
0	1	G	R	B
1	0	Y	Pb	Pr
1	1	Y	Pr	Pb

DESIGN FEATURES

OUTPUT OVERSAMPLING

The ADV7390/ADV7391/ADV7392/ADV7393 include an on-chip phase-locked loop (PLL) that allows for oversampling of SD, ED, and HD video data. By default, the PLL is disabled. The PLL can be enabled using Subaddress 0x00, Bit 1 = 0.

Table 40 shows the various oversampling rates supported in the ADV7390/ADV7391/ADV7392/ADV7393.

External Sync Polarity

For SD and ED/HD modes, the ADV7390/ADV7391/ADV7392/ADV7393 parts typically expect HS and VS to be low during their

respective blanking periods. However, when the CEA861 compliance bit is enabled (0x39, Bit 5 for ED/HD modes and 0x86, Bit 3 for SD modes), the part expects the HS or VS to be active low or high depending on the input format selected (0x30, Bits[7:3]).

If a different polarity other than the default is required for ED/HD modes, 0x3A, Bits[2:0] can be used to invert PHSYNCB, PVSYNCB or PBLANKB individually regardless of whether CEA-861-B mode is enabled. It is not possible to invert S_HSYNC or S_VSYNC.

Table 40. Output Oversampling Modes and Rates

Input Mode (0x01, Bits[6:4])		PLL and Oversampling Control (0x00, Bit 1)	SD/ED Oversample Rate Select (0x0D, Bit 3) ¹	HD Oversample Rate Select (0x31, Bit 1) ¹	Oversampling Mode and Rate
000	SD	1	X	X	SD (2×)
000	SD	0	1	X	SD (8×)
000	SD	0	0	X	SD (16×)
001/010	ED	1	X	X	ED (1×)
001/010	ED	0	1	X	ED (4×)
001/010	ED	0	0	X	ED (8×)
001/010	HD	1	X	X	HD (1×)
001/010	HD	0	X	1	HD (2×)
001/010	HD	0	X	0	HD (4×)
111	ED (at 54 MHz)	1	X	X	ED (at 54 MHz) (1×)
111	ED (at 54 MHz)	0	1	X	ED (at 54 MHz) (4×)
111	ED (at 54 MHz)	0	0	X	ED (at 54 MHz) (8×)

¹ X = don't care.

DESIGN FEATURES

HD INTERLACE EXTERNAL HSYNC AND VSYNC CONSIDERATIONS

If the encoder revision code (Subaddress 0xBB, Bits[7:6]) = 01 or higher, the user should set Subaddress 0x02, Bit 1 to high. To ensure correct timing in HD interlace modes when using HSYNC and VSYNC synchronization signals. If this bit is set to low, the first active pixel on each line is masked in HD interlace modes and the Pr and Pb outputs are swapped when using the YCrCb 4:2:2 input format. Setting Subaddress 0x02, Bit 1 to low causes the encoder to behave in the same way as the first version of silicon (that is, this setting is backward compatible).

If the encoder revision code (Subaddress 0xBB, Bits[7:6]) = 00, the setting of Subaddress 0x02, Bit 1 has no effect. In this version of the encoder, the first active pixel is masked and the Pr and Pb outputs are swapped when using YCrCb 4:2:2 input format. To avoid these limitations, use the newer revision of silicon or use a different type of synchronization.

These considerations apply only to the HD interlace modes with external HSYNC and VSYNC synchronization (EAV/SAV mode is not affected and always has correct timing).

There is no negative effect in setting Subaddress 0x02, Bit 0 to high, and this bit can remain high for all the other video standards.

ED/HD TIMING RESET

Subaddress 0x34, Bit 0

An ED/HD timing reset is achieved by setting the ED/HD timing reset control bit (Subaddress 0x34, Bit 0) to 1. In this state, the horizontal and vertical counters remain reset. When this bit is set back to 0, the internal counters resume counting. This timing reset applies to the ED/HD timing counters only.

SD SUBCARRIER FREQUENCY LOCK

Subcarrier Frequency Lock (SFL) Mode

In subcarrier frequency lock (SFL) mode (Subaddress 0x84, Bits[2:1] = 11), the ADV7390/ADV7391/ADV7392/ADV7393 can be used to lock to an external video source. The SFL mode allows the ADV7390/ADV7391/ADV7392/ADV7393 to automatically alter the subcarrier frequency to compensate for line length variations. When the part is connected to a device such as an ADV7403 video decoder that outputs a digital data stream in the SFL format, the part automatically changes to the compensated subcarrier frequency on a line-by-line basis (see Figure 65). This digital data stream is 67 bits wide, and the subcarrier is contained in Bit 0 to Bit 21. Each bit is two clock cycles long.

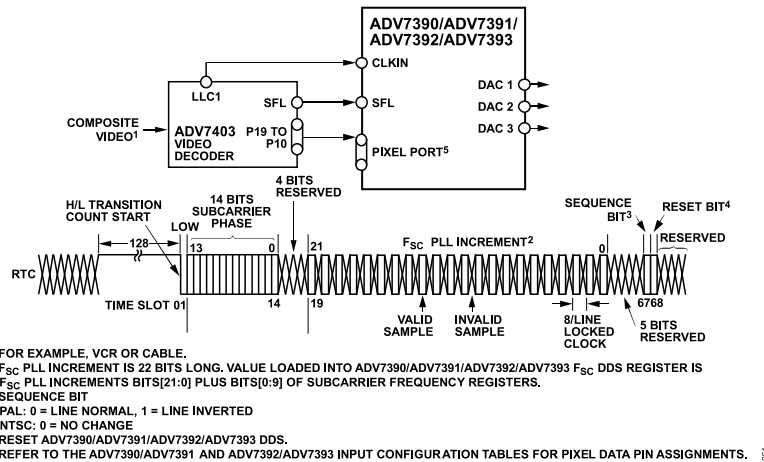

Figure 65. SD Subcarrier Frequency Lock Timing and Connections Diagram (Subaddress 0x84, Bits [2:1] = 11)

DESIGN FEATURES

SD VCR FF/RW SYNC

Subaddress 0x82, Bit 5

In DVD record applications where the encoder is used with a decoder, the VCR FF/RW sync control bit can be used for nonstandard input video, that is, in fast forward or rewind modes.

In fast forward mode, the sync information at the start of a new field in the incoming video usually occurs before the correct number of lines/fields is reached. In rewind mode, this sync signal usually occurs after the total number of lines/fields is reached. Conventionally, this means that the output video has corrupted field signals because one signal is generated by the incoming video and another is generated when the internal line/field counters reach the end of a field.

When the VCR FF/RW sync control is enabled (Subaddress 0x82, Bit 5), the line/field counters are updated according to the incoming VSYNC signal and when the analog output matches the incoming VSYNC signal. This control is available in all subordinate-timing modes except Subordinate Mode 0.

VERTICAL BLANKING INTERVAL

Subaddress 0x31, Bit 4; Subaddress 0x83, Bit 4

The ADV7390/ADV7391/ADV7392/ADV7393 are able to accept input data that contains vertical blanking interval (VBI) data (such as CGMS, WSS, VITS) in SD, ED, and HD modes.

If VBI is disabled (Subaddress 0x31, Bit 4 for ED/HD; Subaddress 0x83, Bit 4 for SD), VBI data is not present at the output and the entire VBI is blanked. These control bits are valid in all main and subordinate timing modes.

For the SMPTE 293M (525p) standard, VBI data can be inserted on Line 13 to Line 42 of each frame or on Line 6 to Line 43 for the ITU-R BT.1358 (625p) standard. VBI data can be present on Line 10 to Line 20 for NTSC and on Line 7 to Line 22 for PAL.

In SD Timing Mode 0 (subordinate option), if VBI is enabled, the blanking bit in the EAV/SAV code is overwritten. It is possible to use VBI in this timing mode as well.

If CGMS is enabled and VBI is disabled, the CGMS data is, nevertheless, available at the output.

SD SUBCARRIER FREQUENCY CONTROL

Subaddress 0x8C to Subaddress 0x8F

The ADV7390/ADV7391/ADV7392/ADV7393 are able to generate the color subcarrier used in CVBS and S-Video (Y-C) outputs from the input pixel clock. Four 8-bit registers are used to set up the subcarrier frequency. The value of these registers is calculated using the following equation:

$$\text{Subcarrier Frequency Register} = \frac{\text{Number of subcarrier periods in one video line}}{\text{Number of 27 MHz clock cycles in one video line}} \times 2^{32} \quad (1)$$

where the sum is rounded to the nearest integer.

For example, in NTSC mode:

$$\text{Subcarrier Register Value} = \left(\frac{227.5}{1716} \right) \times 2^{32} = 569408543 \infty \quad (2)$$

where:

$$\text{Subcarrier Register Value} = 569408543d = 0 \times 21F07C1F$$

SD F_{SC} Register 0: 0x1F

SD F_{SC} Register 1: 0x7C

SD F_{SC} Register 2: 0xF0

SD F_{SC} Register 3: 0x21

Programming the F_{SC}

The subcarrier frequency register value is divided into four F_{SC} registers as shown in the previous example. The four subcarrier frequency registers must be updated sequentially, starting with Subcarrier Frequency Register 0 and ending with Subcarrier Frequency Register 3. The subcarrier frequency updates only after the last subcarrier frequency register byte is received by the ADV7390/ADV7391/ADV7392/ADV7393. The SD input standard autodetection feature must be disabled.

Typical F_{SC} Values

Table 41 outlines the values that should be written to the subcarrier frequency registers for NTSC and PAL B/D/G/H/I.

Table 41. Typical F_{SC} Values

Subaddress	Description	NTSC	PAL B/D/G/H/I
0x8C	F _{SC} 0	0x1F	0xCB
0x8D	F _{SC} 1	0x7C	0x8A
0x8E	F _{SC} 2	0xF0	0x09
0x8F	F _{SC} 3	0x21	0x2A

SD NONINTERLACED MODE

Subaddress 0x88, Bit 1

The ADV7390/ADV7391/ADV7392/ADV7393 support an SD noninterlaced mode. Using this mode, progressive inputs at twice the frame rate of NTSC and PAL (240p/59.94 Hz and 288p/50 Hz, respectively) can be input into the ADV7390/ADV7391/ADV7392/ADV7393. The SD noninterlaced mode can be enabled using Subaddress 0x88, Bit 1.

A 27 MHz clock signal must be provided on the CLKIN pin. Embedded EAV/SAV timing codes or external horizontal and vertical synchronization signals provided on the HSYNC and VSYNC pins can be used to synchronize the input pixel data.

DESIGN FEATURES

FILTERS

Table 42 shows an overview of the programmable filters available on the ADV7390/ADV7391/ADV7392/ADV7393.

Table 42. Selectable Filters

Filter	Subaddress
SD Luma LPF NTSC	0x80
SD Luma LPF PAL	0x80
SD Luma Notch NTSC	0x80
SD Luma Notch PAL	0x80
SD Luma SSAF	0x80
SD Luma CIF	0x80
SD Luma QCIF	0x80
SD Chroma 0.65 MHz	0x80
SD Chroma 1.0 MHz	0x80
SD Chroma 1.3 MHz	0x80
SD Chroma 2.0 MHz	0x80
SD Chroma 3.0 MHz	0x80
SD Chroma CIF	0x80
SD Chroma QCIF	0x80
SD PrPb SSAF	0x82
ED/HD Sinc Compensation Filter	0x33
ED/HD Chroma SSAF	0x33

SD Internal Filter Response

Subaddress 0x80, Bits[7:2]; Subaddress 0x82, Bit 0

The Y filter supports several different frequency responses, including two low-pass responses, two notch responses, an extended (SSAF) response with or without gain boost attenuation, a CIF response, and a QCIF response. The PrPb filter supports several different frequency responses, including six low-pass responses, a CIF response, and a QCIF response, as shown in Figure 40 and Figure 41.

If SD Luma SSAF gain is enabled (Subaddress 0x87, Bit 4), there are 13 response options in the range -4 dB to +4 dB. The desired response can be programmed using Subaddress 0xA2. Variation in frequency responses is shown in Figure 37 to Figure 39.

In addition to the chroma filters listed in Table 42, the ADV7390/ADV7391/ADV7392/ADV7393 contain an SSAF filter that is specifically designed for the color difference component outputs, Pr and Pb. This filter has a cutoff frequency of ~2.7 MHz and a gain of -40 dB at 3.8 MHz (see Figure 68). This filter can be controlled with Bit 0 of Sub-address 0x82, Bit 0.

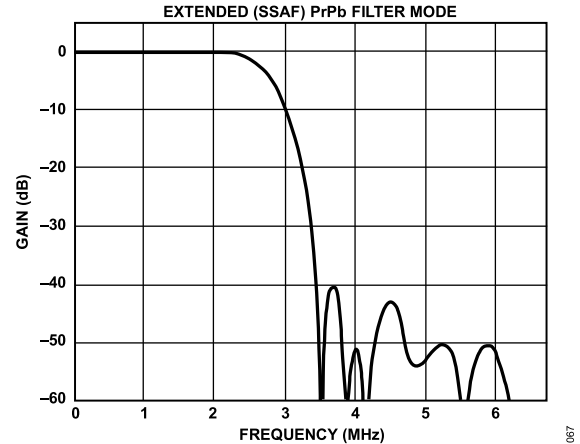

Figure 68. PrPb SSAF Filter

If this filter is disabled, one of the chroma filters shown in Table 43 can be selected and used for the CVBS or luma/chroma signal.

Table 43. Internal Filter Specifications

Filter	Pass-Band Ripple (dB) ¹	3 dB Bandwidth (MHz) ²
Luma LPF NTSC	0.16	4.24
Luma LPF PAL	0.1	4.81
Luma Notch NTSC	0.09	2.3/4.9/6.6
Luma Notch PAL	0.1	3.1/5.6/6.4
Luma SSAF	0.04	6.45
Luma CIF	0.127	3.02
Luma QCIF	Monotonic	1.5
Chroma 0.65 MHz	Monotonic	0.65
Chroma 1.0 MHz	Monotonic	1
Chroma 1.3 MHz	0.09	1.395
Chroma 2.0 MHz	0.048	2.2
Chroma 3.0 MHz	Monotonic	3.2
Chroma CIF	Monotonic	0.65
Chroma QCIF	Monotonic	0.5

¹ Pass-band ripple is the maximum fluctuation from the 0 dB response in the pass band, measured in decibels. The pass band is defined to have 0 Hz to f_c (Hz) frequency limits for a low-pass filter and 0 Hz to f_1 (Hz) and f_2 (Hz) to infinity for a notch filter, where f_c , f_1 , and f_2 are the -3 dB points.

² 3 dB bandwidth refers to the -3 dB cutoff frequency.

ED/HD Sinc Compensation Filter Response

Subaddress 0x33, Bit 3

The ADV7390/ADV7391/ADV7392/ADV7393 include a filter designed to counter the effect of sinc roll-off in DAC 1, DAC 2, and DAC 3 while operating in ED/HD mode. This filter is enabled by default. It can be disabled using Subaddress 0x33, Bit 3. The benefit of the filter is illustrated in Figure 69 and Figure 70.

DESIGN FEATURES

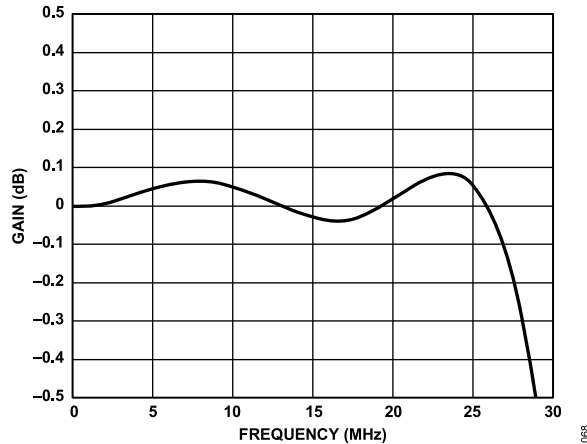

Figure 69. ED/HD Sinc Compensation Filter Enabled

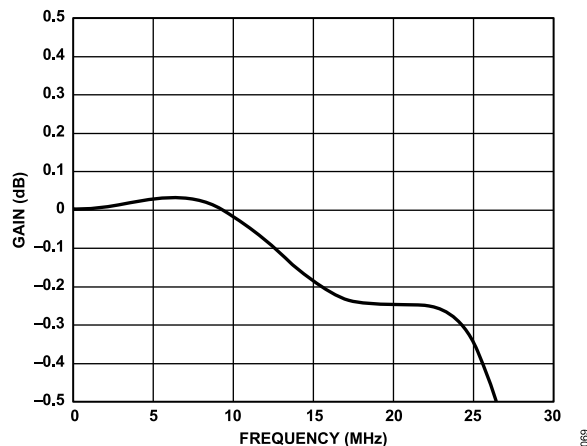

Figure 70. ED/HD Sinc Compensation Filter Disabled

ED/HD TEST PATTERN COLOR CONTROLS

Subaddress 0x36 to Subaddress 0x38

Three 8-bit registers at Subaddress 0x36 to Subaddress 0x38 are used to program the output color of the internal ED/HD test pattern generator (Subaddress 0x31, Bit 2 = 1), whether it be the lines of the crosshatch pattern or the uniform field test pattern. They are not functional as color controls for external pixel data input.

The values for the luma (Y) and color difference (Cr and Cb) signals used to obtain white, black, and saturated primary and complementary colors conform to the ITU-R BT.601-4 standard.

Table 44 shows sample color values that can be programmed into the color registers when the output standard selection is set to EIA770.2/EIA770.3 (Subaddress 0x30, Bits[1:0] = 00).

Table 44. Sample Color Values for EIA770.2/EIA770.3 ED/HD Output Standard Selection

Sample Color	Y Value	Cr Value	Cb Value
White	235 (0xEB)	128 (0x80)	128 (0x80)
Black	16 (0x10)	128 (0x80)	128 (0x80)

Table 44. Sample Color Values for EIA770.2/EIA770.3 ED/HD Output Standard Selection (Continued)

Sample Color	Y Value	Cr Value	Cb Value
Red	81 (0x51)	240 (0xF0)	90 (0x5A)
Green	145 (0x91)	34 (0x22)	54 (0x36)
Blue	41 (0x29)	110 (0x6E)	240 (0xF0)
Yellow	210 (0xD2)	146 (0x92)	16 (0x10)
Cyan	170 (0xAA)	16 (0x10)	166 (0xA6)
Magenta	106 (0x6A)	222 (0xDE)	202 (0xCA)

COLOR SPACE CONVERSION MATRIX

Subaddress 0x03 to Subaddress 0x09

The internal color space conversion (CSC) matrix automatically performs all color space conversions based on the input mode programmed in the mode select register (Subaddress 0x01, Bits[6:4]). Table 45 and Table 46 show the options available in this matrix.

An SD color space conversion from RGB-in to YPrPb-out is possible on the ADV7392/ADV7393. An ED/HD color space conversion from RGB-in to YPrPb-out is not possible.

Table 45. SD Color Space Conversion Options

Input	Output ¹	YPrPb/RGB Out (Subaddress 0x02, Bit 5)	RGB In/YCrCb In (Subaddress 0x87, Bit 7)
YCrCb	YPrPb	1	0
YCrCb	RGB	0	0
RGB ²	YPrPb	1	1
RGB ²	RGB	0	1

¹ CVBS/Y-C outputs are available for all CSC combinations.

² Available on the ADV7392/ADV7393 (40-pin devices) only.

Table 46. ED/HD Color Space Conversion Options

Input	Output	YPrPb/RGB Out (Subaddress 0x02, Bit 5)
YCrCb	YPrPb	1
YCrCb	RGB	0

SD Manual CSC Matrix Adjust Feature

The SD manual CSC matrix adjust feature (available for the ADV7392 and ADV7393 only) provides custom coefficient manipulation for RGB to YPbPr conversion (for YPbPr to RGB conversion, this matrix adjustment is not available).

Normally, there is no need to modify the SD matrix coefficients because the CSC matrix automatically performs the color space conversion based on the output color space selected (see Table 46). Note that Bit 7 in subaddress 0x87 must be set to enable RGB input and, therefore, use the CSC manual adjustment.

The SD CSC matrix scalar uses the following equations:

$$Y = (a1 \times R) + (a2 \times G) + (a3 \times B) + a4$$

$$Pr = (b1 \times R) + (b2 \times G) + (b3 \times B) + b4$$

DESIGN FEATURES

$$Pb = (c1 \times R) + (c2 \times G) + (c3 \times B) + c4$$

The coefficients and their default values are located in the registers shown in [Table 47](#).

Table 47. SD Manual CSC Matrix Default Values

Coefficient	Subaddress	Default
a1	0xBD	0x42
a2	0xBE	0x81
a3	0xBF	0x19
a4	0xC0	0x10
b1	0xC1	0x70
b2	0xC2	0x5E
b3	0xC3	0x12
b4	0xC4	0x80
c1	0xC5	0x26
c2	0xC6	0x4A
c3	0xC7	0x70
c4	0xC8	0x80

ED/HD Manual CSC Matrix Adjust Feature

The ED/HD manual CSC matrix adjust feature provides custom coefficient manipulation for color space conversions and is used in ED and HD modes only. The ED/HD manual CSC matrix adjust feature can be enabled using Subaddress 0x02, Bit 3.

Normally, there is no need to enable this feature because the CSC matrix automatically performs the color space conversion based on the input mode chosen (ED or HD) and the output color space selected (see [Table 46](#)). For this reason, the ED/HD manual CSC matrix adjust feature is disabled by default.

If RGB output is selected, the ED/HD CSC matrix scalar uses the following equations:

$$R = GY \times Y + RV \times Pr$$

$$G = GY \times Y - (GU \times Pb) - (GV \times Pr)$$

$$B = GY \times Y + BU \times Pb$$

Note that subtractions are implemented in the hardware.

If YPrPb output is selected, the following equations are used:

$$Y = GY \times Y$$

$$Pr = RV \times Pr$$

$$Pb = BU \times Pb$$

where:

GY = Subaddress 0x05, Bits[7:0] and Subaddress 0x03, Bits[1:0].

GU = Subaddress 0x06, Bits[7:0] and Subaddress 0x04, Bits[7:6].

GV = Subaddress 0x07, Bits[7:0] and Subaddress 0x04, Bits[5:4].

BU = Subaddress 0x08, Bits[7:0] and Subaddress 0x04, Bits[3:2].

RV = Subaddress 0x09, Bits[7:0] and Subaddress 0x04, Bits[1:0].

On power-up, the CSC matrix is programmed with the default values shown in [Table 48](#).

Table 48. ED/HD Manual CSC Matrix Default Values

Subaddress	Default
0x03	0x03
0x04	0xF0
0x05	0x4E
0x06	0x0E
0x07	0x24
0x08	0x92
0x09	0x7C

When the ED/HD manual CSC matrix adjust feature is enabled, the default coefficient values in Subaddress 0x03 to Subaddress 0x09 are correct for the HD color space only. The color components are converted according to the following 1080i and 720p standards (SMPTE 274M, SMPTE 296M):

$$R = Y + 1.575Pr$$

$$G = Y - 0.468Pr - 0.187Pb$$

$$B = Y + 1.855Pb$$

The conversion coefficients should be multiplied by 315 before being written to the ED/HD CSC matrix registers. This is reflected in the default values for $GY = 0x13B$, $GU = 0x03B$, $GV = 0x093$, $BU = 0x248$, and $RV = 0x1F0$.

If the ED/HD manual CSC matrix adjust feature is enabled and another input standard (such as ED) is used, the scale values for GY , GU , GV , BU , and RV must be adjusted according to this input standard color space. The user should consider that the color component conversion may use different scale values.

For example, SMPTE 293M uses the following conversion:

$$R = Y + 1.402Pr$$

$$G = Y - 0.714Pr - 0.344Pb$$

$$B = Y + 1.773Pb$$

The programmable CSC matrix is used for external ED/HD pixel data and is not functional when internal test patterns are enabled.

Programming the CSC Matrix

If custom manipulation of the ED/HD CSC matrix coefficients is required for a YCrCb-to-RGB color space conversion, use the following procedure:

1. Enable the ED/HD manual CSC matrix adjust feature (Subaddress 0x02, Bit 3).
2. Set the output to RGB (Subaddress 0x02, Bit 5).
3. Disable sync on PrPb (Subaddress 0x35, Bit 2).
4. Enable sync on RGB (optional) (Subaddress 0x02, Bit 4).

DESIGN FEATURES

The GY value controls the green signal output level, the BU value controls the blue signal output level, and the RV value controls the red signal output level.

SD LUMA AND COLOR SCALE CONTROL

Subaddress 0x9C to Subaddress 0x9F

When enabled, the SD luma and color scale control feature can be used to scale the SD Y, Cb, and Cr output levels. This feature can be enabled using Subaddress 0x87, Bit 0. This feature affects all SD output signals, that is, CVBS, Y-C, YPrPb, and RGB.

When enabled, three 10-bit registers (SD Y scale, SD Cb scale, and SD Cr scale) control the scaling of the SD Y, Cb, and Cr output levels. The SD Y scale register contains the scaling factor used to scale the Y level from 0.0 to 1.5 times its initial level. The SD Cb scale and SD Cr scale registers contain the scaling factors to scale the Cb and Cr levels from 0.0 to 2.0 times their initial levels, respectively.

The values to be written to these 10-bit registers are calculated using the following equation:

$$Y, Cb, \text{ or } Cr \text{ Scale Value} = \text{Scale Factor} \times 512$$

For example, if *Scale Factor* = 1.3

$$Y, Cb, \text{ or } Cr \text{ Scale Value} = 1.3 \times 512 = 665.6$$

$$Y, Cb, \text{ or } Cr \text{ Scale Value} = 666 \text{ (rounded to the nearest integer)}$$

$$Y, Cb, \text{ or } Cr \text{ Scale Value} = 1010011010b$$

Subaddress 0x9C, SD scale LSB = 0x2A

Subaddress 0x9D, SD Y scale register = 0xA6

Subaddress 0x9E, SD Cb scale register = 0xA6

Subaddress 0x9F, SD Cr scale register = 0xA6

It is recommended that the SD luma scale saturation feature (Subaddress 0x87, Bit 1) be enabled when scaling the Y output level to avoid excessive Y output levels.

SD HUE ADJUST CONTROL

Subaddress 0xA0

When enabled, the SD hue adjust control register (Subaddress 0xA0) is used to adjust the hue on the SD composite and chroma outputs. This feature can be enabled using Subaddress 0x87, Bit 2.

Subaddress 0xA0 contains the bits required to vary the hue of the video data, that is, the variance in phase of the subcarrier during active video with respect to the phase of the subcarrier during the color burst. The ADV7390/ADV7391/ADV7392/ADV7393 provide a range of $\pm 22.5^\circ$ in increments of 0.17578125° . For normal operation (zero adjustment), this register is set to 0x80. Value 0xFF and Value 0x00 represent the upper and lower limits, respectively, of the attainable adjustment in NTSC mode. Value 0xFF and Value 0x01

represent the upper and lower limits, respectively, of the attainable adjustment in PAL mode.

The hue adjust value is calculated using the following equation:

$$\text{Hue Adjust } (^\circ) = 0.17578125^\circ (HCR_d - 128)$$

Where HCR_d = the hue adjust control register (decimal).

For example, to adjust the hue by $+4^\circ$, write 0x97 to the hue adjust control register.

$$\left(\frac{4}{0.17578125}\right) + 128 \approx 151d = 0x97$$

where the sum is rounded to the nearest integer.

To adjust the hue by -4° , write 0x69 to the hue adjust control register.

$$\left(\frac{-4}{0.17578125}\right) + 128 \approx 105d = 0x69$$

where the sum is rounded to the nearest integer.

SD BRIGHTNESS DETECT

Subaddress 0xBA

The ADV7390/ADV7391/ADV7392/ADV7393 allow monitoring of the brightness level of the incoming video data. This feature is used to monitor the average brightness of the incoming Y signal on a field-by-field basis. The information is read from the I²C and, based on this information, the color saturation, contrast, and brightness controls can be adjusted (for example, to compensate for very dark pictures).

The luma data is monitored in the active video area only. The average brightness I²C register is updated on the falling edge of every VSYNC signal. The SD brightness detect register (Subaddress 0xBA) is a read-only register.

SD BRIGHTNESS CONTROL

Subaddress 0xA1, Bits[6:0]

When this feature is enabled, the SD brightness/WSS control register (Subaddress 0xA1) is used to control brightness by adding a programmable setup level onto the scaled Y data. This feature can be enabled using Subaddress 0x87, Bit 3.

For NTSC with pedestal, the setup can vary from 0 IRE to 22.5 IRE. For NTSC without pedestal (see Figure 71) and for PAL, the setup can vary from -7.5 IRE to $+15$ IRE.

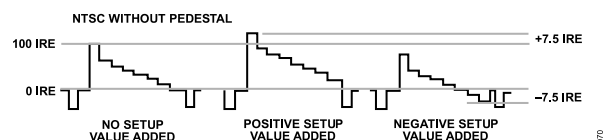

Figure 71. Examples of Brightness Control Values

DESIGN FEATURES

The SD brightness control register is an 8-bit register. The seven LSBs of this 8-bit register are used to control the brightness level, which can be a positive or negative value.

For example, to add a +20 IRE brightness level to an NTSC signal with pedestal, write 0x28 to Subaddress 0xA1.

$$0 \times (\text{SD Brightness Value}) =$$

$$0 \times (\text{IRE Value} \times 2.015631) =$$

$$0 \times (20 \times 2.015631) = 0 \times (40.31262) \approx 0x28$$

To add a -7 IRE brightness level to a PAL signal, write 0x72 to Subaddress 0xA1.

$$0 \times (\text{SD Brightness Value}) =$$

$$0 \times (\text{IRE Value} \times 2.075631) =$$

$$0 \times (7 \times 2.015631) = 0x(14.109417) \approx 0001110b$$

$$0001110b \text{ into twos complement} = 1110010b = 0x72$$

Table 49. Sample Brightness Control Values¹

Setup Level (NTSC) with Pedestal	Setup Level (NTSC) Without Pedestal	Setup Level (PAL)	Brightness Control Value
22.5 IRE	15 IRE	15 IRE	0x1E
15 IRE	7.5 IRE	7.5 IRE	0x0F
7.5 IRE	0 IRE	0 IRE	0x00
0 IRE	-7.5 IRE	-7.5 IRE	0x71

¹ Values in the range of 0x3F to 0x44 may result in an invalid output signal.

SD INPUT STANDARD AUTODETECTION

Subaddress 0x87, Bit 5

The ADV7390/ADV7391/ADV7392/ADV7393 include an SD input standard autodetect feature that can be enabled by setting Subaddress 0x87, Bits[5:1].

When enabled, the ADV7390/ADV7391/ADV7392/ADV7393 can automatically identify an NTSC or a PAL B/D/G/H/I input stream. The ADV7390/ADV7391/ADV7392/ADV7393 automatically update the subcarrier frequency registers with the appropriate value for the identified standard. The ADV7390/ADV7391/ADV7392/ADV7393 are also configured to correctly encode the identified standard.

The SD standard bits (Subaddress 0x80, Bits[1:0]) and the subcarrier frequency registers are not updated to reflect the identified standard. All registers retain their default or user-defined values.

DOUBLE BUFFERING

Subaddress 0x33, Bit 7 for ED/HD; Subaddress 0x88, Bit 2 for SD

Double-buffered registers are updated once per field. Double buffering improves overall performance because modifications to register

settings are not be made during active video but take effect prior to the start of the active video on the next field.

Using Subaddress 0x33, Bit 7, double buffering can be activated on the following ED/HD registers: the ED/HD Gamma A and Gamma B curves and ED/HD CGMS registers.

Using Subaddress 0x88, Bit 2, double buffering can be activated on the following SD registers: the SD Gamma A and Gamma B curves, SD Y scale, SD Cr scale, SD Cb scale, SD brightness, SD closed captioning, and SD Macrovision Bits[5:0] (Subaddress 0xE0, Bits[5:0]).

PROGRAMMABLE DAC GAIN CONTROL

Subaddress 0x0B

It is possible to adjust the DAC output signal gain up or down from its absolute level. This is illustrated in [Figure 72](#).

DAC 1 to DAC 3 are controlled by Register 0x0B.

In Case A of [Figure 72](#), the video output signal is gained. The absolute level of the sync tip and the blanking level increase with respect to the reference video output signal. The overall gain of the signal is increased from the reference signal.

In Case B of [Figure 72](#), the video output signal is reduced. The absolute level of the sync tip and the blanking level decrease with respect to the reference video output signal. The overall gain of the signal is reduced from the reference signal.

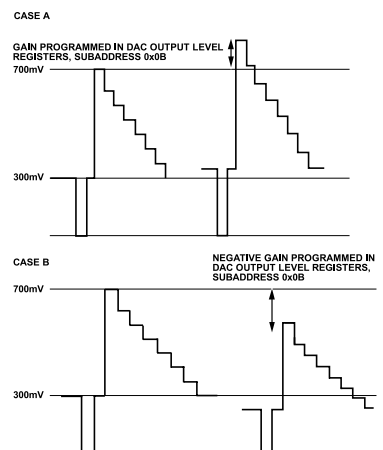

Figure 72. Programmable DAC Gain—Positive and Negative Gain

The range of this feature is specified for $\pm 7.5\%$ of the nominal output from the DACs. For example, if the output current of the DAC is 4.33 mA, the DAC gain control feature can change this output current from 4.008 mA (-7.5%) to 4.658 mA ($+7.5\%$).

The reset value of the control registers is 0x00; that is, nominal DAC current is output. [Table 50](#) is an example of how the output current of the DACs varies for a nominal 4.33 mA output current.

DESIGN FEATURES

Table 50. DAC Gain Control

Subaddress 0x0B	DAC Current (mA)	% Gain	Note
0100 0000 (0x40)	4.658	7.5000%	
0011 1111 (0x3F)	4.653	7.3820%	
0011 1110 (0x3E)	4.648	7.3640%	
...	
...	
0000 0010 (0x02)	4.43	0.0360%	
0000 0001 (0x01)	4.38	0.0180%	
0000 0000 (0x00)	4.33	0.0000%	Reset value, nominal
1111 1111 (0xFF)	4.25	-0.0180%	
1111 1110 (0xFE)	4.23	-0.0360%	
...	
...	
1100 0010 (0xC2)	4.018	-7.3640%	
1100 0001 (0xC1)	4.013	-7.3820%	
1100 0000 (0xC0)	4.008	-7.5000%	

GAMMA CORRECTION

Subaddress 0x44 to Subaddress 0x57 for ED/HD; Subaddress 0xA6 to Subaddress 0xB9 for SD

Generally, gamma correction is applied to compensate for the nonlinear relationship between signal input and output brightness level (as perceived on a CRT). It can also be applied wherever nonlinear processing is used.

Gamma correction uses the function

$$Signal_{OUT} = (Signal_{IN})^\gamma$$

where γ is the gamma correction factor.

Gamma correction is available for SD and ED/HD video. For both variations, there are twenty 8-bit registers. They are used to program Gamma Correction Curve A and Gamma Correction Curve B.

ED/HD gamma correction is enabled using Subaddress 0x35, Bit 5. ED/HD Gamma Correction Curve A is programmed at Subaddress 0x44 to Subaddress 0x4D, and ED/HD Gamma Correction Curve B is programmed at Subaddress 0x4E to Subaddress 0x57.

SD gamma correction is enabled using Subaddress 0x88, Bit 6. SD Gamma Correction Curve A is programmed at Subaddress 0xA6 to Subaddress 0xAF, and SD Gamma Correction Curve B is programmed at Subaddress 0xB0 to Subaddress 0xB9.

Gamma correction is performed on the luma data only. The user can choose one of two correction curves, Curve A or Curve B. Only one of these curves can be used at a time. For ED/HD gamma correction, curve selection is controlled using Subaddress 0x35, Bit

4. For SD gamma correction, curve selection is controlled using Subaddress 0x88, Bit 7.

The shape of the gamma correction curve is controlled by defining the curve response at 10 different locations along the curve. By altering the response at these locations, the shape of the gamma correction curve can be modified. Between these points, linear interpolation is used to generate intermediate values. Considering the curve to have a total length of 256 points, the 10 programmable locations are at the following points: 24, 32, 48, 64, 80, 96, 128, 160, 192, and 224. The following locations are fixed and cannot be changed: 0, 16, 240, and 255.

From the curve locations, 16 to 240, the values at the programmable locations and, therefore, the response of the gamma correction curve, should be calculated to produce the following result:

$$X_{DESIRED} = (X_{INPUT})^\gamma$$

where:

$X_{DESIRED}$ is the desired gamma corrected output.

X_{INPUT} is the linear input signal.

γ is the gamma correction factor.

To program the gamma correction registers, calculate the 10 programmable curve values using the following formula:

$$Y_n = \left(\left(\frac{n-16}{240-16} \right)^\gamma \times (240-16) \right) + 16 \quad (3)$$

where:

Y_n is the value to be written into the gamma correction register for point n on the gamma correction curve.

$n = 24, 32, 48, 64, 80, 96, 128, 160, 192, \text{ or } 224.$

γ is the gamma correction factor.

For example, setting $\gamma = 0.5$ for all programmable curve data points results in the following Y_n values:

$$Y_{24} = [(8/224)^{0.5} \times 224] + 16 = 58$$

$$Y_{32} = [(16/224)^{0.5} \times 224] + 16 = 76$$

$$Y_{48} = [(32/224)^{0.5} \times 224] + 16 = 101$$

$$Y_{64} = [(48/224)^{0.5} \times 224] + 16 = 120$$

$$Y_{80} = [(64/224)^{0.5} \times 224] + 16 = 136$$

$$Y_{96} = [(80/224)^{0.5} \times 224] + 16 = 150$$

$$Y_{128} = [(112/224)^{0.5} \times 224] + 16 = 174$$

$$Y_{160} = [(144/224)^{0.5} \times 224] + 16 = 195$$

$$Y_{192} = [(176/224)^{0.5} \times 224] + 16 = 214$$

$$Y_{224} = [(208/224)^{0.5} \times 224] + 16 = 232$$

where the sum of each equation is rounded to the nearest integer.

The gamma curves in Figure 73 and Figure 74 are examples only; any user-defined curve in the range from 16 to 240 is acceptable.

DESIGN FEATURES

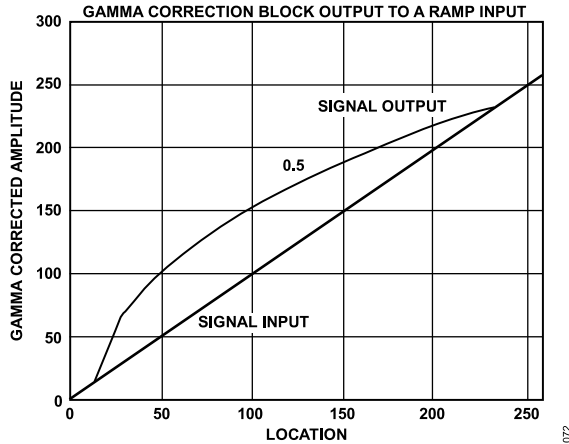

Figure 73. Signal Input (Ramp) and Signal Output for Gamma 0.5

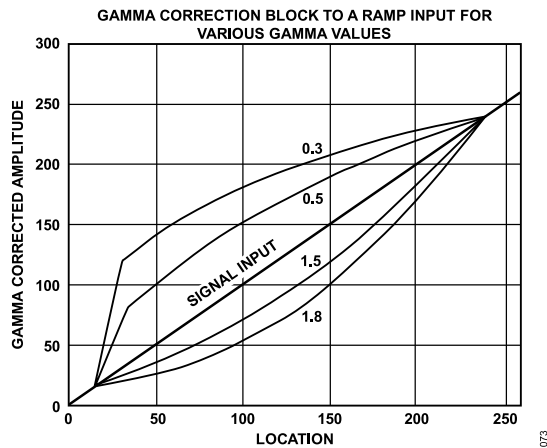

Figure 74. Signal Input (Ramp) and Selectable Output Curves

ED/HD SHARPNESS FILTER AND ADAPTIVE FILTER CONTROLS

Subaddress 0x40; Subaddress 0x58 to Subaddress 0x5D

There are three filter modes available on the ADV7390/ADV7391/ADV7392/ADV7393: sharpness filter mode and two adaptive filter modes.

ED/HD Sharpness Filter Mode

To enhance or attenuate the Y signal in the frequency ranges shown in Figure 75, the ED/HD sharpness filter must be enabled (Subaddress 0x31, Bit 7 = 1) and the ED/HD adaptive filter must be disabled (Subaddress 0x35, Bit 7 = 0).

To select one of the 256 individual responses, the corresponding gain values, ranging from -8 to $+7$ for each filter, must be programmed into the ED/HD sharpness filter gain register at Subaddress 0x40.

ED/HD Adaptive Filter Mode

In ED/HD adaptive filter mode, the following registers are used:

- ▶ ED/HD Adaptive Filter Threshold A
- ▶ ED/HD Adaptive Filter Threshold B
- ▶ ED/HD Adaptive Filter Threshold C
- ▶ ED/HD Adaptive Filter Gain 1
- ▶ ED/HD Adaptive Filter Gain 2
- ▶ ED/HD Adaptive Filter Gain 3
- ▶ ED/HD sharpness filter gain

To activate the adaptive filter control, the ED/HD sharpness filter and the ED/HD adaptive filter must be enabled (Subaddress 0x31, Bit 7 = 1, and Subaddress 0x35, Bit 7 = 1, respectively).

The derivative of the incoming signal is compared to the three programmable threshold values: ED/HD adaptive filter (Threshold A, Threshold B, and Threshold C) registers (Subaddress 0x5B, Subaddress 0x5C, and Subaddress 0x5D). The recommended threshold range is 16 to 235, although any value in the range of 0 to 255 can be used.

The edges can then be attenuated with the settings in the ED/HD adaptive filter (Gain 1, Gain 2, and Gain 3) registers (Subaddress 0x58, Subaddress 0x59 and Subaddress 0x5A), and the ED/HD sharpness filter gain register (Subaddress 0x40).

There are two adaptive filter modes available. The mode is selected using the ED/HD adaptive filter mode control (Subaddress 0x35, Bit 6) as follows:

- ▶ Mode A is used when the ED/HD adaptive filter mode control is set to 0. In this case, Filter B (LPF) is used in the adaptive filter block. In addition, only the programmed values for Gain B in the ED/HD sharpness filter gain register and ED/HD adaptive filter (Gain 1, Gain 2, and Gain 3) registers are applied when needed. The Gain A values are fixed and cannot be changed.
- ▶ Mode B is used when ED/HD adaptive filter mode control is set to 1. In this mode, a cascade of Filter A and Filter B is used. Both settings for Gain A and Gain B in the ED/HD sharpness filter gain register and ED/HD adaptive filter (Gain 1, Gain 2, and Gain 3) registers become active when needed.

DESIGN FEATURES

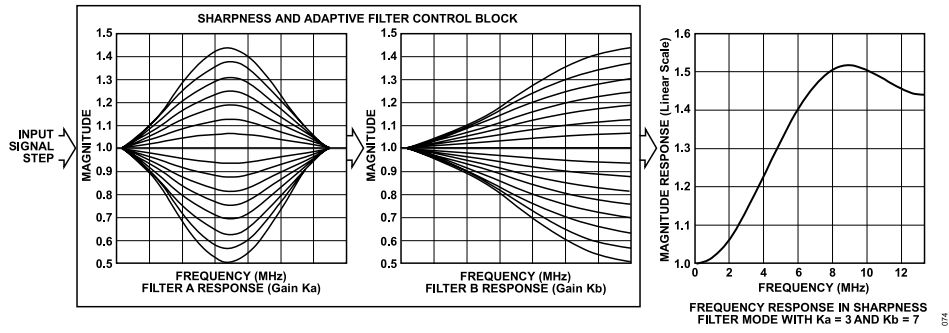

Figure 75. ED/HD Sharpness and Adaptive Filter Control

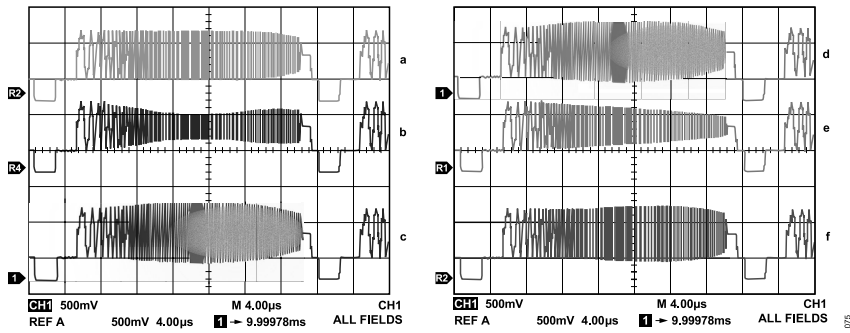

Figure 76. ED/HD Sharpness Filter Control with Different Gain Settings for ED/HD Sharpness Filter Gain Values

DESIGN FEATURES

ED/HD SHARPNESS FILTER AND ADAPTIVE FILTER APPLICATION EXAMPLES

Sharpness Filter Application

The ED/HD sharpness filter can be used to enhance or attenuate the Y video output signal. The register settings in Table 51 are used to achieve the results shown in Figure 76. Input data is generated by an external signal source.

Table 51. ED/HD Sharpness Control Settings for Figure 76

Subaddress	Register Setting	Reference ¹
0x00	0xFC	
0x01	0x10	
0x02	0x20	
0x30	0x00	
0x31	0x81	
0x40	0x00	a
0x40	0x08	b
0x40	0x04	c
0x40	0x40	d
0x40	0x80	e
0x40	0x22	f

¹ See Figure 76.

Adaptive Filter Control Application

The register settings in Table 52 are used to obtain the results shown in Figure 78, that is, to remove the ringing on the input Y signal, as shown in Figure 77. Input data is generated by an external signal source.

Table 52. Register Settings for Figure 76

Subaddress	Register Setting
0x00	0xFC
0x01	0x38
0x02	0x20
0x30	0x00
0x31	0x81
0x35	0x80
0x40	0x00
0x58	0xAC
0x59	0x9A
0x5A	0x88
0x5B	0x28
0x5C	0x3F
0x5D	0x64

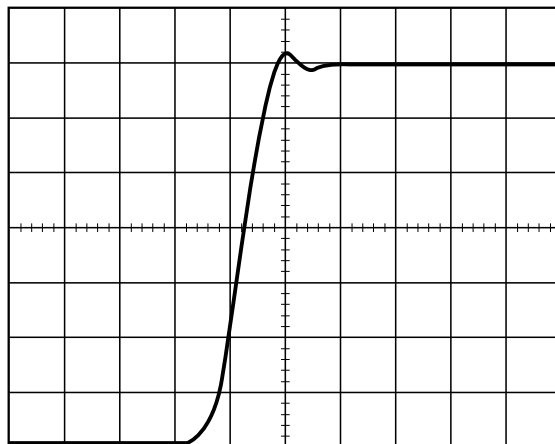

076

Figure 77. Input Signal to ED/HD Adaptive Filter

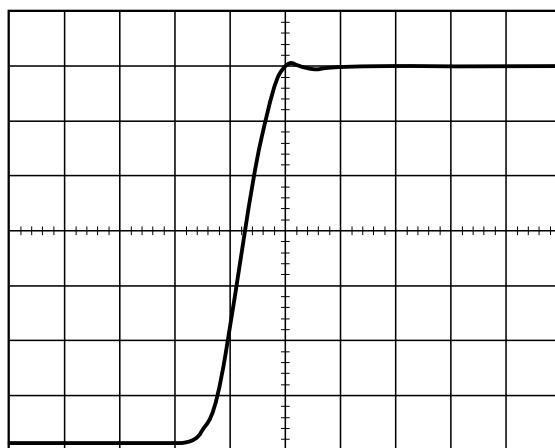

077

Figure 78. Output Signal from ED/HD Adaptive Filter (Mode A)

When the adaptive filter mode is changed to Mode B (Subaddress 0x35, Bit 6), the output shown in Figure 79 can be obtained.

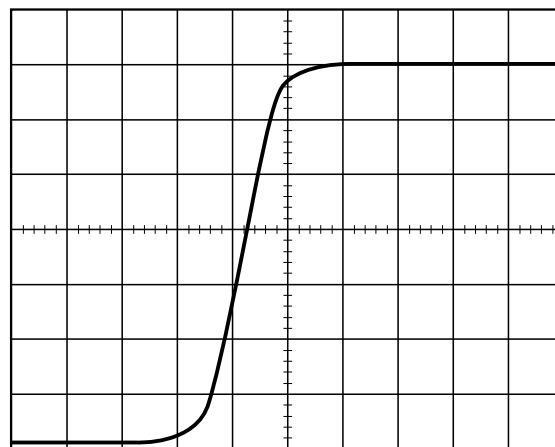

078

Figure 79. Output Signal from ED/HD Adaptive Filter (Mode B)

DESIGN FEATURES

SD DIGITAL NOISE REDUCTION

Subaddress 0xA3 to Subaddress 0xA5

Digital noise reduction (DNR) is applied to the Y data only. A filter block selects the high frequency, low amplitude components of the incoming signal (DNR input select). The absolute value of the filter output is compared to a programmable threshold value (DNR threshold control). There are two DNR modes available: DNR mode and DNR sharpness mode.

In DNR mode, if the absolute value of the filter output is smaller than the threshold, it is assumed to be noise. A programmable amount (coring gain border, coring gain data) of this noise signal is subtracted from the original signal. In DNR sharpness mode, if the absolute value of the filter output is less than the programmed threshold, it is assumed to be noise as before. However, if the level exceeds the threshold, now being identified as a valid signal, a fraction of the signal (coring gain border, coring gain data) is added to the original signal to boost high frequency components and sharpen the video image.

In MPEG systems, it is common to process the video information in blocks of 8 pixels \times 8 pixels for MPEG2 systems or 16 pixels \times 16 pixels for MPEG1 systems (block size control). DNR can be applied to the resulting block transition areas known to contain noise. Generally, the block transition area contains two pixels. It is possible to define this area to contain four pixels (border area).

It is also possible to compensate for variable block positioning or differences in YCrCb pixel timing with the use of the DNR block offset.

The digital noise reduction registers are three 8-bit registers. They are used to control the DNR processing.

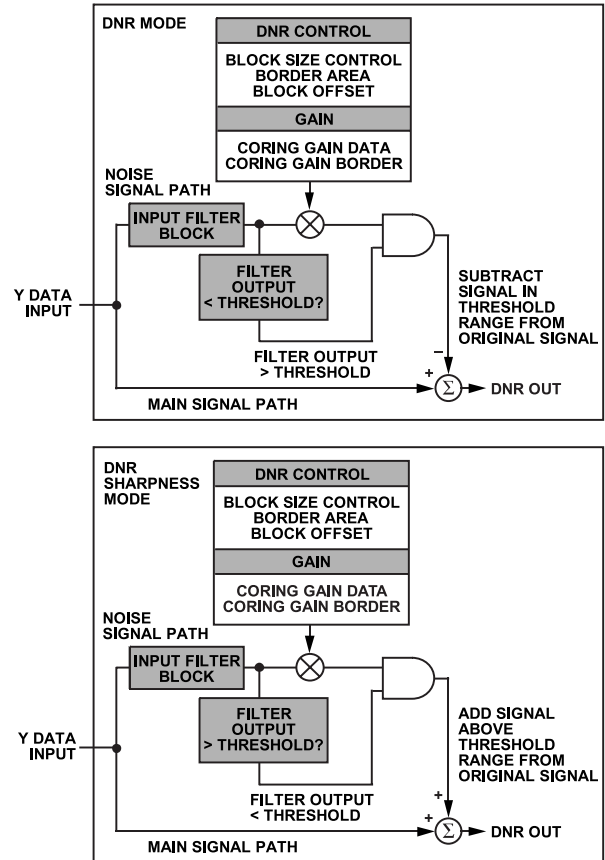

Figure 80. SD DNR Block Diagram

Coring Gain Border—Subaddress 0xA3, Bits[3:0]

These four bits are assigned to the gain factor applied to border areas. In DNR mode, the range of gain values is 0 to 1 in increments of 1/8. This factor is applied to the DNR filter output that lies below the set threshold range. The result is then subtracted from the original signal.

In DNR sharpness mode, the range of gain values is 0 to 0.5 in increments of 1/16. This factor is applied to the DNR filter output that lies above the threshold range. The result is added to the original signal.

Coring Gain Data—Subaddress 0xA3, Bits[7:4]

These four bits are assigned to the gain factor applied to the luma data inside the MPEG pixel block. In DNR mode, the range of gain values is 0 to 1 in increments of 1/8. This factor is applied to the DNR filter output that lies below the set threshold range. The result is then subtracted from the original signal.

In DNR sharpness mode, the range of gain values is 0 to 0.5 in increments of 1/16. This factor is applied to the DNR filter output that lies above the threshold range. The result is added to the original signal.

DESIGN FEATURES

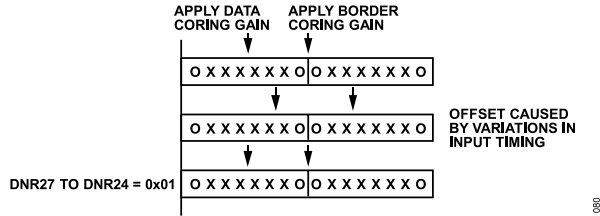

Figure 81. SD DNR Offset Control

DNR Threshold—Subaddress 0xA4, Bits[5:0]

These six bits are used to define the threshold value in the range of 0 to 63. The range is an absolute value.

Border Area—Subaddress 0xA4, Bit 6

When this bit is set to Logic 1, the block transition area can be defined to consist of four pixels. If this bit is set to Logic 0, the border transition area consists of two pixels, where one pixel refers to two clock cycles at 27 MHz.

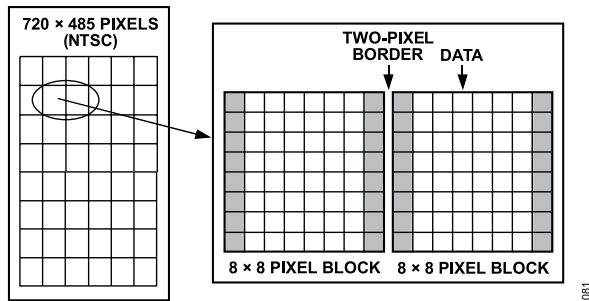

Figure 82. SD DNR Border Area

Block Size—Subaddress 0xA4, Bit 7

This bit is used to select the size of the data blocks to be processed. Setting the block size control function to Logic 1 defines a 16 pixel x 16 pixel data block, and Logic 0 defines an 8 pixel x 8 pixel data block, where one pixel refers to two clock cycles at 27 MHz.

DNR Input Select—Subaddress 0xA5, Bits[2:0]

These three bits are assigned to select the filter that is applied to the incoming Y data. The signal that lies in the pass band of the selected filter is the signal processed by DNR. Figure 83 shows the filter responses selectable with this control.

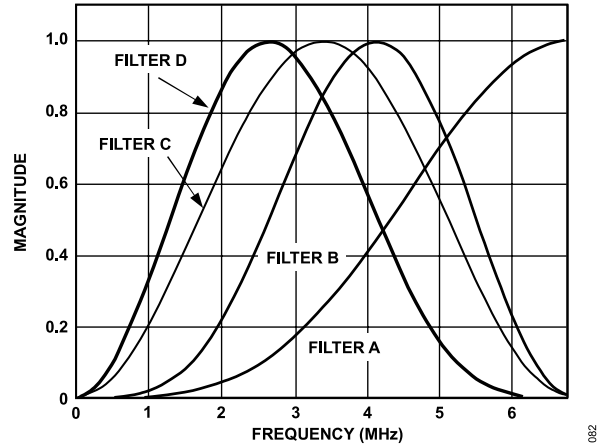

Figure 83. SD DNR Input Select

DNR Mode—Subaddress 0xA5, Bit 3

This bit controls the DNR mode selected. Logic 0 selects DNR mode; Logic 1 selects DNR sharpness mode.

DNR works on the principle of defining low amplitude, high frequency signals as probable noise and subtracting this noise from the original signal.

In DNR mode, it is possible to subtract a fraction of the signal that lies below the set threshold, assumed to be noise, from the original signal. The threshold is set in DNR Register 1.

When DNR sharpness mode is enabled, it is possible to add a fraction of the signal that lies above the set threshold to the original signal because this data is assumed to be valid data and not noise. The overall effect is that the signal is boosted (similar to using the extended SSAF filter).

Block Offset Control—Subaddress 0xA5, Bits[7:4]

Four bits are assigned to this control, which allows a shift in the data block of 15 pixels maximum. The coring gain positions are fixed. The block offset shifts the data in steps of one pixel such that the border coring gain factors can be applied at the same position regardless of variations in input timing of the data.

SD ACTIVE VIDEO EDGE CONTROL

Subaddress 0x82, Bit 7

The ADV7390/ADV7391/ADV7392/ADV7393 are able to control fast rising and falling signals at the start and end of active video to minimize ringing.

When the active video edge control feature is enabled (Subaddress 0x82, Bit 7 = 1), the first three pixels and the last three pixels of the active video on the luma channel are scaled so that maximum transitions on these pixels are not possible.

DESIGN FEATURES

At the start of active video, the first three pixels are multiplied by 1/8, 1/2, and 7/8, respectively. Approaching the end of active video,

the last three pixels are multiplied by 7/8, 1/2, and 1/8, respectively. All other active video pixels pass through unprocessed.

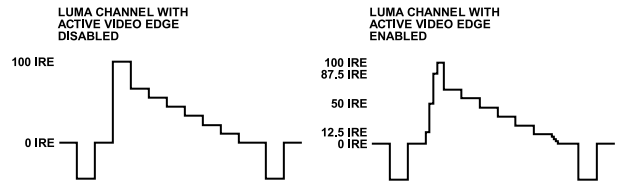

Figure 84. Example of Active Video Edge Functionality

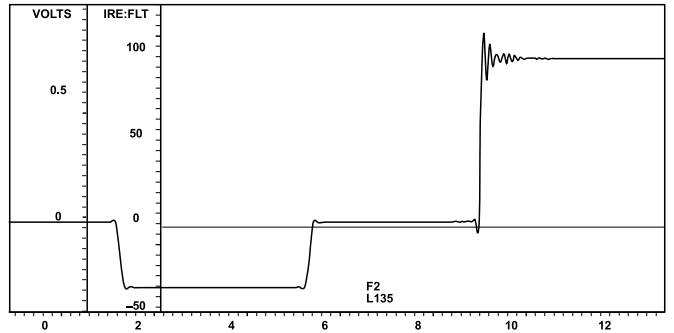

Figure 85. Example of Video Output with Subaddress 0x82, Bit 7 = 0

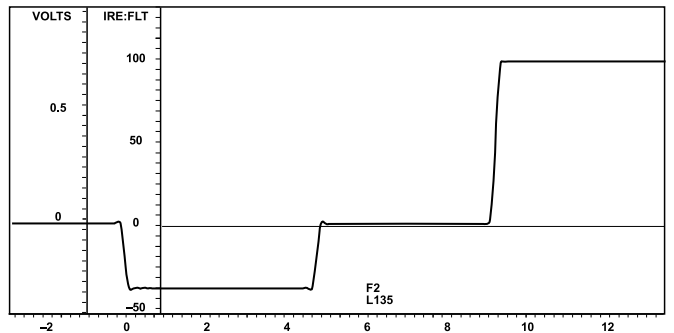

Figure 86. Example of Video Output with Subaddress 0x82, Bit 7 = 1

EXTERNAL HORIZONTAL AND VERTICAL SYNCHRONIZATION CONTROL

For timing synchronization purposes, the ADV7390/ADV7391/ADV7392/ADV7393 are able to accept either EAV/SAV time codes embedded in the input pixel data or external synchronization signals provided on the $\overline{\text{HSYNC}}$ and $\overline{\text{VSYNC}}$ pins (see Table 53). It is also possible to output synchronization signals on the $\overline{\text{HSYNC}}$ and $\overline{\text{VSYNC}}$ pins (see Table 54 to Table 56).

Table 53. Timing Synchronization Signal Input Options

Signal	Pin	Condition
SD $\overline{\text{HSYNC}}$ In	$\overline{\text{HSYNC}}$	SD subordinate timing (Mode 1, Mode 2, or Mode 3) selected (Subaddress 0x8A[2:0]) ¹
SD $\overline{\text{VSYNC}}$ /FIELD In	$\overline{\text{VSYNC}}$	SD subordinate timing (Mode 1, Mode 2, or Mode 3) selected (Subaddress 0x8A[2:0]) ¹
ED/HD $\overline{\text{HSYNC}}$ In	$\overline{\text{HSYNC}}$	ED/HD timing synchronization inputs enabled (Subaddress 0x30, Bit 2 = 0)
ED/HD $\overline{\text{VSYNC}}$ /FIELD In	$\overline{\text{VSYNC}}$	ED/HD timing synchronization inputs enabled (Subaddress 0x30, Bit 2 = 0)

¹ SD and ED/HD timing synchronization outputs must also be disabled (Subaddress 0x02[7:6] = 00).

DESIGN FEATURES

Table 54. Timing Synchronization Signal Output Options

Signal	Pin	Condition
SD HSYNC Out	HSYNC	SD timing synchronization outputs enabled (Subaddress 0x02, Bit 6 = 1) ¹
SD VSYNC/FIELD Out	VSYNC	SD timing synchronization outputs enabled (Subaddress 0x02, Bit 6 = 1) ¹
ED/HD HSYNC Out	HSYNC	ED/HD timing synchronization outputs enabled (Subaddress 0x02, Bit 7 = 1) ²
ED/HD VSYNC/FIELD Out	VSYNC	ED/HD timing synchronization outputs enabled (Subaddress 0x02, Bit 7 = 1) ²

¹ ED/HD timing synchronization outputs must also be disabled (Subaddress 0x02, Bit 7 = 0).

² ED/HD timing synchronization inputs must also be disabled; that is, embedded EAV/SAV timing codes must be enabled (Subaddress 0x30, Bit 2 = 1).

Table 55. HSYNC Output Control^{1,2}

ED/HD Input Sync Format (Subaddress 0x30, Bit 2)	ED/HD HSYNC Control (Subaddress 0x34, Bit 1)	ED/HD Sync Output Enable (Subaddress 0x02, Bit 7)	SD Sync Output Enable (Subaddress 0x02, Bit 6)	Signal on HSYNC Pin	Duration
X	X	0	0	Tristate	N/A
X	X	0	1	Pipelined SD HSYNC	See the SD Timing section.
0	0	1	X	Pipelined ED/HD HSYNC	As per HSYNC timing.
1	0	1	X	Pipelined ED/HD HSYNC based on AV Code H bit	Same as line blanking interval.
X	1	1	X	Pipelined ED/HD HSYNC based on horizontal counter	Same as embedded HSYNC.

¹ In all ED/HD standards where there is an HSYNC output, the start of the HSYNC pulse is aligned with the falling edge of the embedded HSYNC in the output video.

² X = don't care.

Table 56. VSYNC Output Control^{1,2}

ED/HD Input Sync Format (Subaddress 0x30, Bit 2)	ED/HD VSYNC Control (Subaddress 0x34, Bit 2)	ED/HD Sync Output Enable (Subaddress 0x02, Bit 7)	SD Sync Output Enable (Subaddress 0x02, Bit 6)	Video Standard	Signal on VSYNC Pin	Duration
x	x	0	0	x	Tristate	N/A
x	x	0	1	Interlaced	Pipelined SD VSYNC/field	See the SD Timing section.
0	0	1	x	x	Pipelined ED/HD VSYNC or field signal	As per VSYNC or field signal timing.
1	0	1	x	All HD interlaced standards	Pipelined field signal based on AV Code F bit	Field.
1	0	1	x	All ED/HD progressive standards	Pipelined VSYNC based on AV Code V bit	Vertical blanking interval.
X	1	1	X	All ED/HD standards except 525p	Pipelined ED/HD VSYNC based on the vertical counter	Aligned with serration lines.
X	1	1	X	525p	Pipelined ED/HD VSYNC based on the vertical counter	Vertical blanking interval.

¹ In all ED/HD standards where there is a VSYNC output, the start of the VSYNC pulse is aligned with the falling edge of the embedded VSYNC in the output video.

² X = don't care.

LOW POWER MODE

Subaddress 0x0D, Bits[2:0]

For power-sensitive applications, the ADV7390/ADV7391/ADV7392/ADV7393 support an Analog Devices, Inc., proprietary

low power mode of operation. To use this low power mode, the DACs must be operating in full-drive mode ($R_{SET} = 510 \Omega$, $R_L = 37.5 \Omega$). Low power mode is not available in low-drive mode ($R_{SET} = 4.12 \text{ k}\Omega$, $R_L = 300 \Omega$). Low power mode can be independently enabled or disabled on each DAC using Subaddress 0x0D, Bits[2:0]. Low power mode is disabled by default on all DACs.

DESIGN FEATURES

In low-power mode, DAC current consumption is content dependent and, on a typical video stream, it can be reduced by as much as 40%. For applications requiring the highest possible video performance, low power mode should be disabled.

CABLE DETECTION

Subaddress 0x10, Bits[1:0]

The ADV7390/ADV7391/ADV7392/ADV7393 include an Analog Devices proprietary cable detection feature. The cable detection feature is available on DAC 1 and DAC 2 when operating in full-drive mode ($R_{SET} = 510 \Omega$, $R_L = 37.5 \Omega$, assuming a connected cable). The feature is not available in low-drive mode ($R_{SET} = 4.12 \text{ k}\Omega$, $R_L = 300 \Omega$). For a DAC to be monitored, the DAC must be powered up in Subaddress 0x00.

The cable detection feature can be used with all SD, ED, and HD video standards. It is available for all output configurations, that is, CVBS, Y-C, YPrPb, and RGB output configurations.

For CVBS/Y-C output configurations, both DAC 1 and DAC 2 are monitored; that is, the CVBS and Y-C luma outputs are monitored. For YPrPb and RGB output configurations, only DAC 1 is monitored; that is, the luma or green output is monitored.

Once per frame, the ADV7390/ADV7391/ADV7392/ADV7393 monitor DAC 1 and/or DAC 2, updating Subaddress 0x10, Bit 0 and/or Bit 1, respectively. If a cable is detected on one of the DACs, the relevant bit is set to 0. If not, the bit is set to 1.

DAC AUTOPOWER-DOWN

Subaddress 0x10, Bit 4

For power-sensitive applications, a DAC autopower-down feature can be enabled using Subaddress 0x10, Bit 4. This feature is available only when the cable detection feature is enabled.

With this feature enabled, the cable detection circuitry monitors DAC 1 and/or DAC 2 once per frame and, if they are unconnected, automatically powers down some or all of the DACs. Which DAC or DACs are powered down depends on the selected output configuration. For CVBS/Y-C output configurations, if DAC 1 is unconnected, only DAC 1 powers down. If DAC 2 is unconnected, DAC 2 and DAC 3 power down.

For YPrPb and RGB output configurations, if DAC 1 is unconnected, all three DACs are powered down. DAC 2 is not monitored for YPrPb and RGB output configurations.

Once per frame, DAC 1 and/or DAC 2 is monitored. If a cable is detected, the appropriate DAC or DACs remain powered up for the duration of the frame. If no cable is detected, the appropriate DAC or DACs power down until the next frame, when the process is repeated.

SLEEP MODE

Subaddress 0x00, Bit 0

In sleep mode, most of the digital I/O pins of the ADV7390/ADV7391/ADV7392/ADV7393 are disabled. For inputs, this means that the external data is ignored, and internally the logic normally driven by a given input is just tied low or high. This includes CLKIN.

For digital output pins, this means that the pin goes into tristate (high impedance) mode.

There are some exceptions to allow the user to continue to communicate with the part via I²C: the RESET, ALSB, SDA and SCL pins are kept alive.

Most of the analogue circuitry is powered down when in sleep mode. In addition, the cable detect feature no longer works as the DACs are powered down.

Sleep mode is enabled using Subaddress 0x00, Bit 0.

PIXEL AND CONTROL PORT READBACK

Subaddress 0x13, Subaddress 0x14, Subaddress 0x16

The ADV7390/ADV7391/ADV7392/ADV7393 support the readback of most digital inputs via the I²C MPU port. This feature is useful for board-level connectivity testing with upstream devices.

The pixel port (P[15:0] or P[7:0]), $\overline{\text{HSYNC}}$, $\overline{\text{VSYNC}}$, and SFL are available for readback via the MPU port. The readback registers are located at Subaddress 0x13, Subaddress 0x14, and Subaddress 0x16.

When using this feature, apply a clock signal to the CLKIN pin to register the levels applied to the input pins. The SD input mode (Subaddress 0x01, Bits[6:4] = 000) must be selected when using this feature.

RESET MECHANISMS

Subaddress 0x17, Bit 1

A hardware reset is activated with a high-to-low transition on the $\overline{\text{RESET}}$ pin in accordance with the timing specifications. This resets all registers to their default values. After a hardware reset, the MPU port is configured for I²C operation. For correct device operation, a hardware reset is necessary after power-up.

The ADV7390/ADV7391/ADV7392/ADV7393 also have a software reset accessible via the I²C MPU port. A software reset is activated by writing a 1 to Subaddress 0x17, Bit 1. This resets all registers to their default values. This bit is self-clearing; that is, after a 1 has been written to the bit, the bit automatically returns to 0.

A hardware reset is necessary after power-up for correct device operation. If no hardware reset functionality is required by the

DESIGN FEATURES

application, the $\overline{\text{RESET}}$ pin can be connected to an RC network to provide the hardware reset necessary after power-up. After power-up, the time constant of the RC network holds the $\overline{\text{RESET}}$ pin low long enough to cause a reset to take place. All subsequent resets can be done via software.

SD TELETEXT INSERTION

Subaddress 0xC9 to Subaddress 0xCE

The ADV7390/ADV7391/ADV7392/ADV7393 support the insertion of teletext data, using a two pin interface, when operating in PAL mode. Teletext insertion is enabled using Subaddress 0xC9, Bit 0.

In accordance with the PAL WST teletext standard, teletext data should be inserted into the ADV7390/ADV7391/ADV7392/ADV7393 at a rate of 6.9375 Mbps. On the ADV7390/ADV7391, the teletext data is inserted on the $\overline{\text{VSYNC}}$ pin. On the ADV7392/ADV7393, the teletext data can be inserted on the $\overline{\text{VSYNC}}$ or P0 pin (selectable through Subaddress 0xC9, Bit 2).

When teletext insertion is enabled, a teletext request signal is output from the ADV7390/ADV7391/ADV7392/ADV7393 to indicate

when teletext data should be inserted. The teletext request signal is output on the SFL pin. The position (relative to the teletext data) and width of the request signal are configurable using Subaddress 0xCA. The request signal can operate in either a line or bit mode. The request signal mode is controlled using Subaddress 0xC9, Bit 1.

To account for the noninteger relationship between the teletext insertion rate (6.9375 Mbps) and the pixel clock (27 MHz), a teletext insertion protocol is implemented in the ADV7390/ADV7391/ADV7392/ADV7393. At a rate of 6.9375 Mbps, the time taken for the insertion of 37 teletext bits equates to 144 pixel clock cycles (at 27 MHz). For every 37 teletext bits inserted into the ADV7390/ADV7391/ADV7392/ADV7393, the 10th, 19th, 28th, and 37th bits are carried for three pixel clock cycles, and the remainder are carried for four pixel clock cycles (totaling 144 pixel clock cycles). The teletext insertion protocol repeats every 37 teletext bits or 144 pixel clock cycles until all 360 teletext bits are inserted.

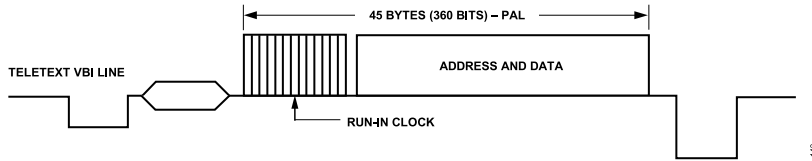

Figure 87. Teletext VBI Line

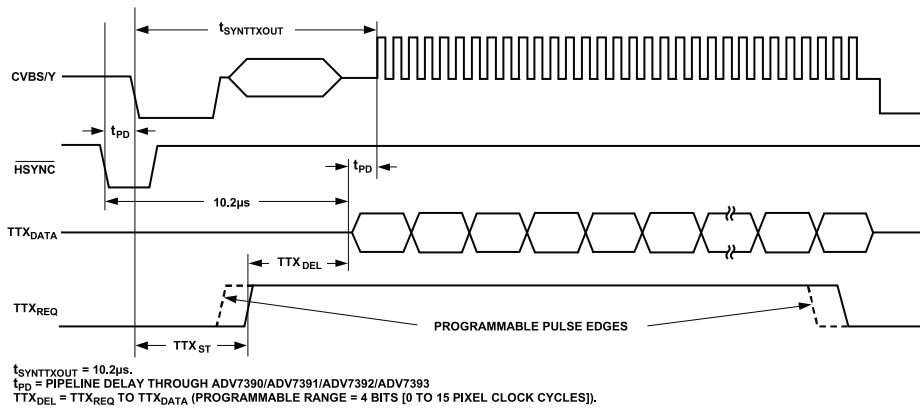

Figure 88. Teletext Functionality Diagram

PRINTED CIRCUIT BOARD LAYOUT AND DESIGN

UNUSED PINS

If the $\overline{\text{HSYNC}}$ and $\overline{\text{VSYNC}}$ pins are not used, they should be tied to V_{DD_IO} through a pull-up resistor (10 k Ω or 4.7 k Ω). Any other unused digital inputs should be tied to ground. Unused digital output pins should be left floating. DAC outputs can either be left floating or connected to GND. Disabling these outputs is recommended.

DAC CONFIGURATIONS

The ADV7390/ADV7391/ADV7392/ADV7393 contain three DACs. All three DACs can be configured to operate in full-drive mode. Full-drive mode is defined as 34.7 mA full-scale current into a 37.5 Ω load, R_L . Full drive is the recommended mode of operation for the DACs.

Alternatively, all three DACs can be configured to operate in low-drive mode. Low-drive mode is defined as 4.33 mA full-scale current into a 300 Ω load, R_L .

The ADV7390/ADV7391/ADV7392/ADV7393 contain an R_{SET} pin. A resistor connected between the R_{SET} pin and AGND is used to control the full-scale output current and, therefore, the output voltage levels of DAC 1, DAC 2, and DAC 3. For full-drive operation, R_{SET} must have a value of 510 Ω and R_L must have a value of 37.5 Ω . For low drive operation, R_{SET} must have a value of 4.12 k Ω , and R_L must have a value of 300 Ω . The resistor connected to the R_{SET} pin should have a 1% tolerance.

The ADV7390/ADV7391/ADV7392/ADV7393 contain a compensation pin, COMP. A 2.2 nF compensation capacitor should be connected from the COMP pin to V_{AA} .

VIDEO OUTPUT BUFFER AND OPTIONAL OUTPUT FILTER

An output buffer is necessary on any DAC that operates in low-drive mode ($R_{SET} = 4.12$ k Ω , $R_L = 300$ Ω). Analog Devices produces a range of op amps suitable for this application, for example, the AD8061. For more information about line driver buffering circuits, see the relevant op amp data sheet.

An optional reconstruction (anti-imaging) low-pass filter (LPF) may be required on the ADV7390/ADV7391/ADV7392/ADV7393 DAC outputs. The filter specifications vary with the application. The use of 16 \times (SD), 8 \times (ED), or 4 \times (HD) oversampling can remove the requirement for a reconstruction filter altogether.

For applications requiring an output buffer and reconstruction filter, the ADA4430-1 and ADA4411-3 integrated video filter buffers should be considered.

Table 57. ADV7390/ADV7391/ADV7392/ADV7393 Output Rates

Input Mode (Subaddress 0x01, Bits[6:4])	Oversampling	Output Rate (MHz)	
SD	Off	27	(2 \times)
	On	108	(8 \times)

Table 57. ADV7390/ADV7391/ADV7392/ADV7393 Output Rates (Continued)

Input Mode (Subaddress 0x01, Bits[6:4])	Oversampling	Output Rate (MHz)	
ED	Off	27	(1 \times)
	On	108	(4 \times)
	On	216	(8 \times)
HD	Off	74.25	(1 \times)
	On	148.5	(2 \times)
	On	297	(4 \times)

Table 58. Output Filter Requirements

Application	Oversampling	Cutoff Frequency (MHz)	Attenuation -50 dB at (MHz)
SD	2 \times	> 6.5	20.5
	8 \times	> 6.5	101.5
	16 \times	> 6.5	209.5
ED	1 \times	> 12.5	14.5
	4 \times	> 12.5	95.5
	8 \times	> 12.5	203.5
HD	1 \times	> 30	44.25
	2 \times	> 30	118.5
	4 \times	> 30	267

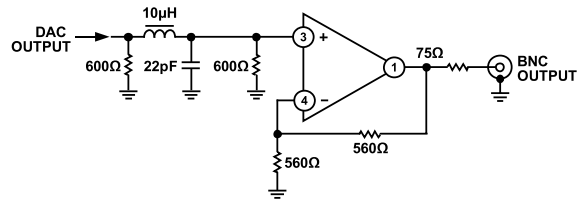

Figure 89. Example of Output Filter for SD, 16 \times Oversampling

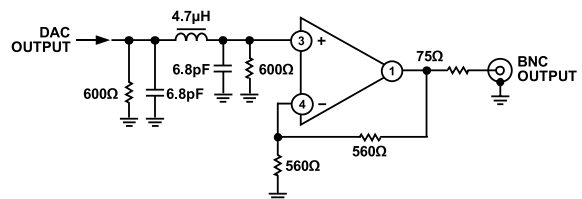

Figure 90. Example of Output Filter for ED, 8 \times Oversampling

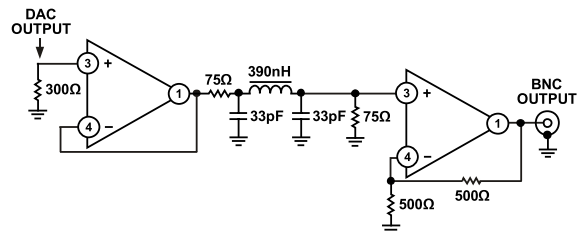

Figure 91. Example of Output Filter for HD, 4 \times Oversampling

PRINTED CIRCUIT BOARD LAYOUT AND DESIGN

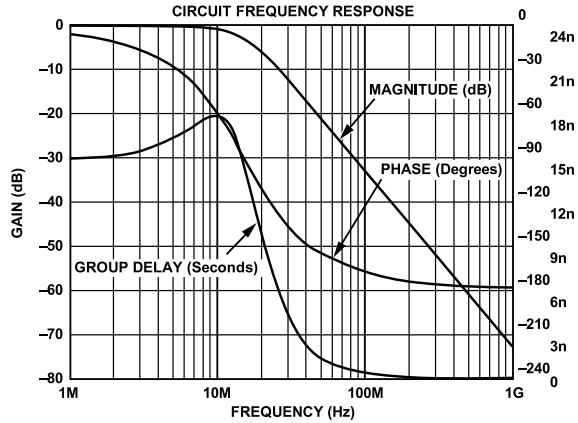

Figure 92. Output Filter Plot for SD, 16× Oversampling

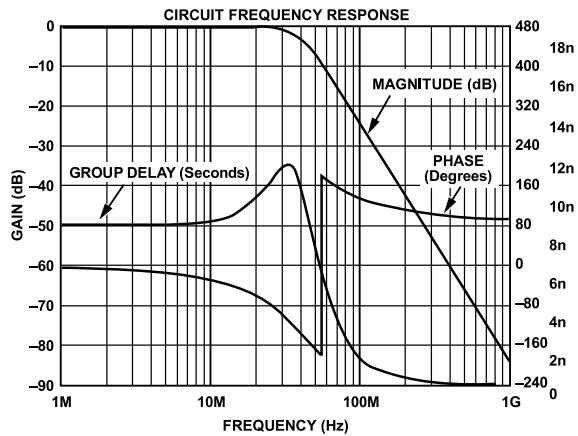

Figure 93. Output Filter Plot for ED, 8× Oversampling

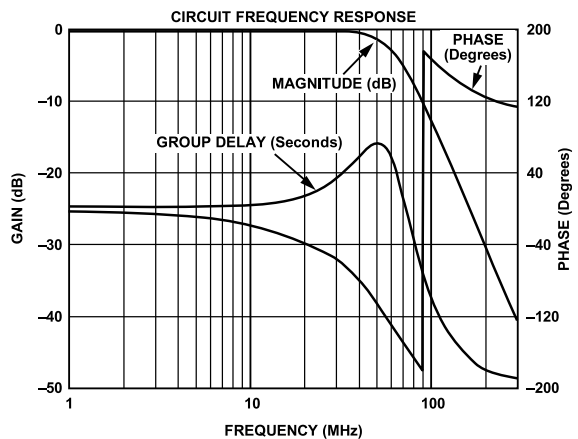

Figure 94. Output Filter Plot for HD, 4× Oversampling

PRINTED CIRCUIT BOARD (PCB) LAYOUT

The ADV7390/ADV7391/ADV7392/ADV7393 are highly integrated circuits containing both precision analog and high speed digital circuitry. It is designed to minimize interference effects on the integrity of the analog circuitry by the high speed digital circuitry. It is imperative that these same design and layout techniques be

applied to the system-level design so that optimal performance is achieved.

The layout should be optimized for lowest noise on the ADV7390/ADV7391/ADV7392/ADV7393 power and ground planes by shielding the digital inputs and providing good power supply decoupling.

It is recommended to use a 4-layer printed circuit board with ground and power planes separating the signal trace layer and the solder side layer.

Component Placement

Component placement should be carefully considered to separate noisy circuits, such as clock signals and high speed digital circuitry, from analog circuitry.

The external loop filter components and components connected to the COMP and R_{SET} pins should be placed as close as possible to, and on the same side of the PCB as, the ADV7390/ADV7391/ADV7392/ADV7393. Adding vias to the PCB to get the components closer to the ADV7390/ADV7391/ADV7392/ADV7393 is not recommended.

It is recommended that the ADV7390/ADV7391/ADV7392/ADV7393 be placed as close as possible to the output connector, with the DAC output traces as short as possible.

The termination resistors on the DAC output traces should be placed as close as possible to and on the same side of the PCB as the ADV7390/ADV7391/ADV7392/ADV7393. The termination resistors should overlay the PCB ground plane.

External filter and buffer components connected to the DAC outputs should be placed as close as possible to the ADV7390/ADV7391/ADV7392/ADV7393 to minimize the possibility of noise pickup from neighboring circuitry and to minimize the effect of trace capacitance on output bandwidth. This is particularly important when operating in low-drive mode ($R_{SET} = 4.12 \text{ k}\Omega$, $R_L = 300 \Omega$).

Power Supplies

It is recommended that a separate regulated supply be provided for each power domain (V_{AA} , V_{DD} , V_{DD_IO} , and PV_{DD}). For optimal performance, linear regulators rather than switch mode regulators should be used. If switch mode regulators must be used, care must be taken with regard to the quality of the output voltage in terms of ripple and noise. This is particularly true for the V_{AA} and PV_{DD} power domains. Each power supply should be individually connected to the system power supply at a single point through a suitable filtering device, such as a ferrite bead.

Power Supply Decoupling

It is recommended that each power supply pin be decoupled with 10 nF and 0.1 μF ceramic capacitors. The V_{AA} , PV_{DD} , V_{DD_IO} , and both V_{DD} pins should be individually decoupled to ground. The decoupling capacitors should be placed as close as possible

PRINTED CIRCUIT BOARD LAYOUT AND DESIGN

to the ADV7390/ADV7391/ADV7392/ADV7393 with the capacitor leads kept as short as possible to minimize lead inductance.

A 1 μ F tantalum capacitor is recommended across the V_{AA} supply in addition to the 10 nF and 0.1 μ F ceramic capacitors.

Power Supply Sequencing

The ADV7390/ADV7391/ADV7392/ADV7393 are robust to all power supply sequencing combinations. Any sequence can be used. However, all power supplies should settle to their nominal voltages within one second.

Digital Signal Interconnect

The digital signal traces should be isolated as much as possible from the analog outputs and other analog circuitry. Digital signal traces should not overlay the V_{AA} or PV_{DD} power plane.

Due to the high clock rates used, avoid long clock traces to the ADV7390/ADV7391/ADV7392/ADV7393 to minimize noise pickup.

Any pull-up termination resistors for the digital inputs should be connected to the V_{DD_IO} power supply.

Analog Signal Interconnect

DAC output traces should be treated as transmission lines with appropriate measures taken to ensure optimal performance (for example, impedance matched traces). The DAC output traces should

be kept as short as possible. The termination resistors on the DAC output traces should be placed as close as possible to, and on the same side of the PCB as, the ADV7390/ADV7391/ADV7392/ADV7393.

To avoid crosstalk between the DAC outputs, it is recommended that as much space as possible be left between the traces connected to the DAC output pins. Adding ground traces between the DAC output traces is also recommended.

ADDITIONAL LAYOUT CONSIDERATIONS FOR THE WLCSP PACKAGE

Due to the high pad density and 0.5 mm pitch of the WLCSP, it is not recommended that connections to inner bumps be routed on the top PCB layer only.

The traces (track and space) must fit within the limits of the solder mask openings. Routing all traces on the top surface layer of the board, while possible, is usually not a feasible solution due to the limitations of the geometries imposed by the board fabrication technology. Given a pitch of 0.5 mm with a typical solder mask opening diameter of 0.35 mm, there is only a 0.15 mm distance between the solder mask openings.

An alternative to routing on the top surface is to route out on buried layers. To achieve this, the pads are connected to the lower layers using microvias. See the [AN-617 Application Note, MicroCSP Wafer Level Chip Scale Package](#) for additional details about the board layout for the WLCSP package.

PRINTED CIRCUIT BOARD LAYOUT AND DESIGN

TYPICAL APPLICATIONS CIRCUITS

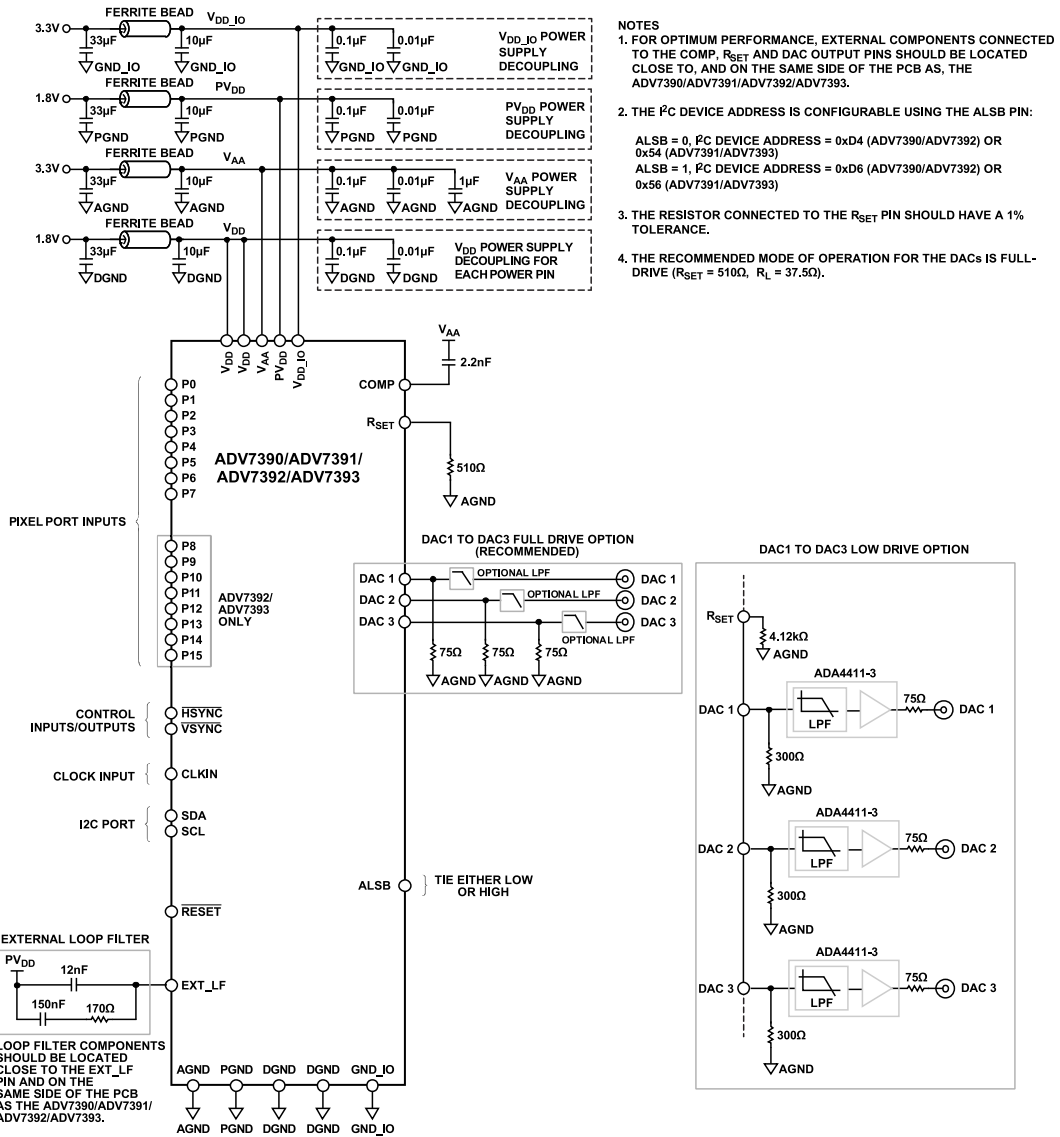

Figure 95. ADV7390/ADV7391/ADV7392/ADV7393 (LFCSP) Typical Applications Circuit

PRINTED CIRCUIT BOARD LAYOUT AND DESIGN

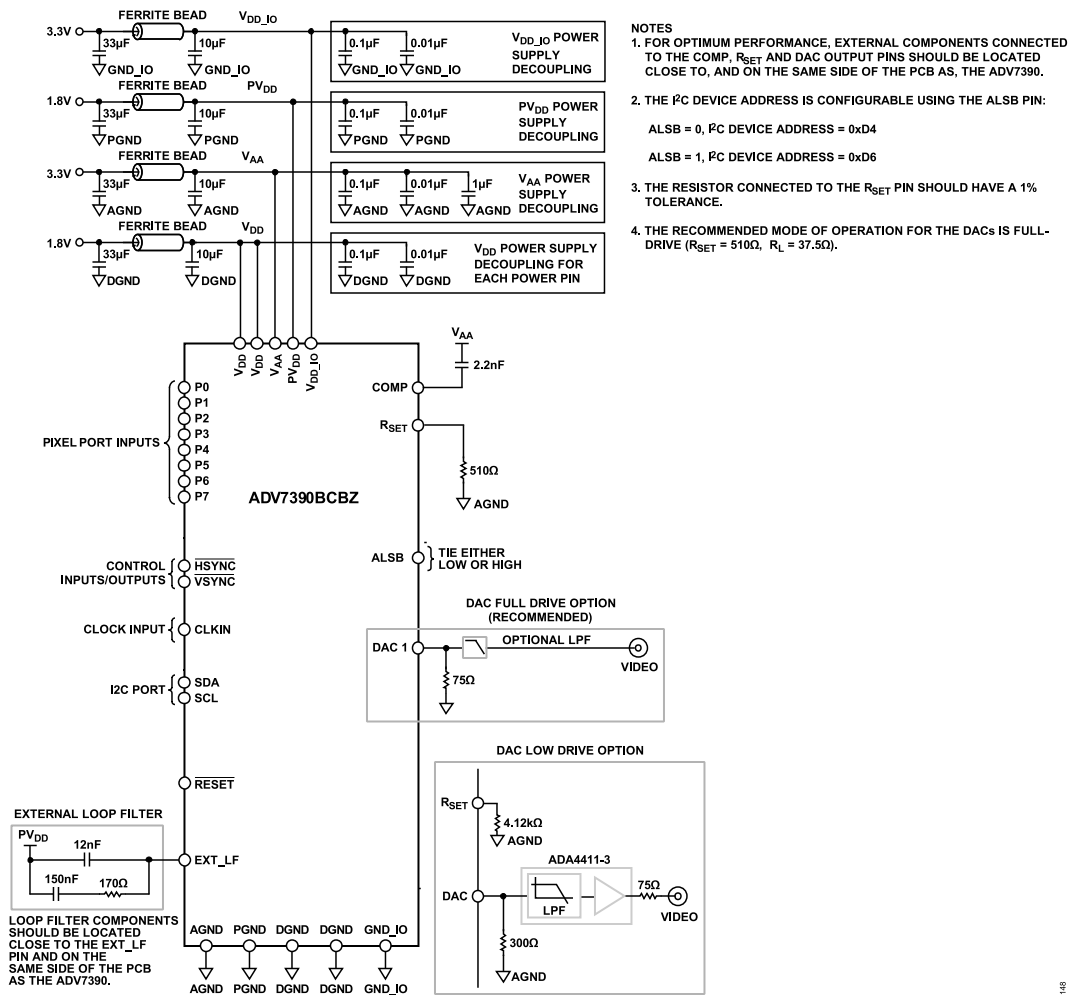

Figure 96. ADV7390BCBZ-A (WLCSP) Typical Applications Circuit

COPY GENERATION MANAGEMENT SYSTEM

SD CGMS

Subaddress 0x99 to Subaddress 0x9B

The ADV7390/ADV7391/ADV7392/ADV7393 support a copy generation management system (CGMS) that conforms to the EIAJ CPR-1204 and ARIB TR-B15 standards. CGMS data is transmitted on Line 20 of odd fields and Line 283 of even fields. Subaddress 0x99, Bits[6:5] control whether CGMS data is output on odd or even fields or both.

SD CGMS data can be transmitted only when the ADV7390/ADV7391/ADV7392/ADV7393 are configured in NTSC mode. The CGMS data is 20 bits long. The CGMS data is preceded by a reference pulse of the same amplitude and duration as a CGMS bit (see [Figure 97](#)).

ED CGMS

Subaddress 0x41 to Subaddress 0x43; Subaddress 0x5E to Subaddress 0x6E

525p Mode

The ADV7390/ADV7391/ADV7392/ADV7393 support a copy generation management system (CGMS) in 525p mode in accordance with EIAJ CPR-1204-1.

When ED CGMS is enabled (Subaddress 0x32, Bit 6 = 1), 525p CGMS data is inserted on Line 41. The 525p CGMS data registers are at Subaddress 0x41, Subaddress 0x42, and Subaddress 0x43.

The ADV7390/ADV7391/ADV7392/ADV7393 also support CGMS Type B packets in 525p mode in accordance with CEA-805-A.

When ED CGMS Type B is enabled (Subaddress 0x5E, Bit 0 = 1), 525p CGMS Type B data is inserted on Line 40. The 525p CGMS Type B data registers are at Subaddress 0x5E to Subaddress 0x6E.

625p Mode

The ADV7390/ADV7391/ADV7392/ADV7393 support a copy generation management system (CGMS) in 625p mode in accordance with IEC 62375 (2004).

When ED CGMS is enabled (Subaddress 0x32, Bit 6 = 1), 625p CGMS data is inserted on Line 43. The 625p CGMS data registers are at Subaddress 0x42 and Subaddress 0x43.

HD CGMS

Subaddress 0x41 to Subaddress 0x43; Subaddress 0x5E to Subaddress 0x6E

The ADV7390/ADV7391/ADV7392/ADV7393 support a copy generation management system (CGMS) in HD mode (720p and 1080i) in accordance with EIAJ CPR-1204-2.

When HD CGMS is enabled (Subaddress 0x32, Bit 6 = 1), 720p CGMS data is applied to Line 24 of the luminance vertical blanking interval.

When HD CGMS is enabled (Subaddress 0x32, Bit 6 = 1), 1080i CGMS data is applied to Line 19 and Line 582 of the luminance vertical blanking interval.

The HD CGMS data registers are at Subaddress 0x41, Subaddress 0x42, and Subaddress 0x43.

The ADV7390/ADV7391/ADV7392/ADV7393 also support CGMS Type B packets in HD mode (720p and 1080i) in accordance with CEA-805-A.

When HD CGMS Type B is enabled (Subaddress 0x5E, Bit 0 = 1), 720p CGMS data is applied to Line 23 of the luminance vertical blanking interval.

When HD CGMS Type B is enabled (Subaddress 0x5E, Bit 0 = 1), 1080i CGMS data is applied to Line 18 and Line 581 of the luminance vertical blanking interval.

The HD CGMS Type B data registers are at Subaddress 0x5E to Subaddress 0x6E.

CGMS CRC FUNCTIONALITY

If SD CGMS CRC (Subaddress 0x99, Bit 4) or ED/HD CGMS CRC (Subaddress 0x32, Bit 7) is enabled, the upper six CGMS data bits (C19 to C14) that comprise the 6-bit CRC check sequence are automatically calculated on the ADV7390/ADV7391/ADV7392/ADV7393. This calculation is based on the lower 14 bits (C13 to C0) of the data in the CGMS data registers, and the result is output with the remaining 14 bits to form the complete 20 bits of the CGMS data. The calculation of the CRC sequence is based on the polynomial $x^6 + x + 1$ with a preset value of 111111.

If SD CGMS CRC or ED/HD CGMS CRC is disabled, all 20 bits (C19 to C0) are output directly from the CGMS registers (CRC must be calculated by the user manually).

If ED/HD CGMS Type B CRC (Subaddress 0x5E, Bit 1) is enabled, the upper six CGMS Type B data bits (P122 to P127) that comprise the 6-bit CRC check sequence are automatically calculated on the ADV7390/ADV7391/ADV7392/ADV7393. This calculation is based on the lower 128 bits (H0 to H5 and P0 to P121) of the data in the CGMS Type B data registers. The result is output with the remaining 128 bits to form the complete 134 bits of the CGMS Type B data. The calculation of the CRC sequence is based on the polynomial $x^6 + x + 1$ with a preset value of 111111.

If ED/HD CGMS Type B CRC is disabled, all 134 bits (H0 to H5 and P0 to P127) are output directly from the CGMS Type B registers (CRC must be calculated by the user manually).

COPY GENERATION MANAGEMENT SYSTEM

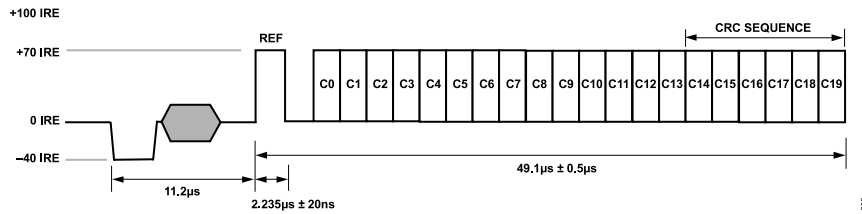

Figure 97. Standard Definition CGMS Waveform

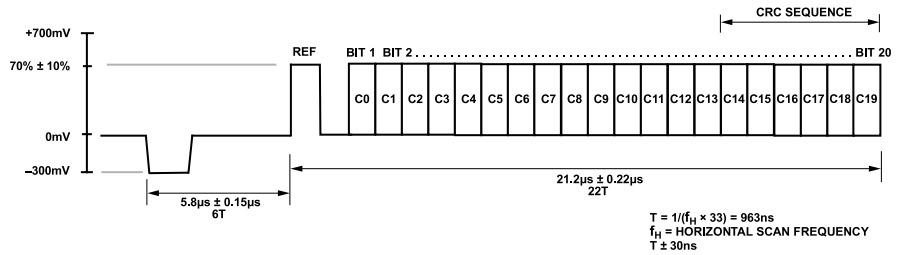

Figure 98. Enhanced Definition (525p) CGMS Waveform

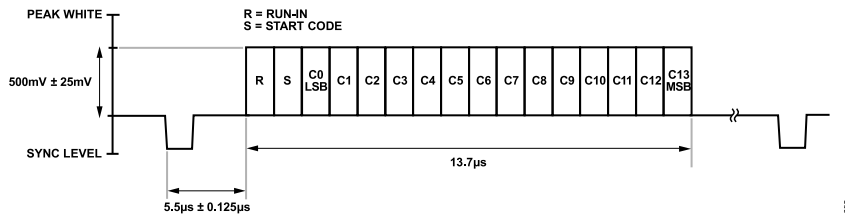

Figure 99. Enhanced Definition (625p) CGMS Waveform

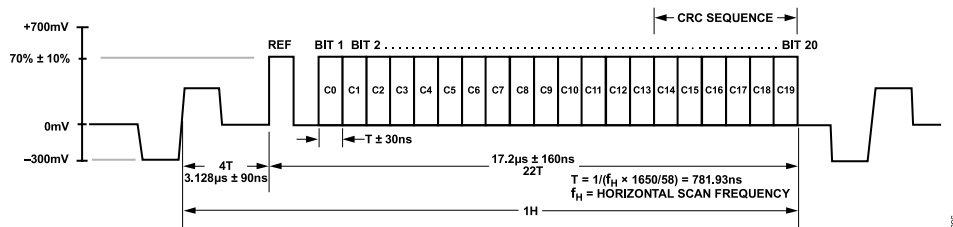

Figure 100. High Definition (720p) CGMS Waveform

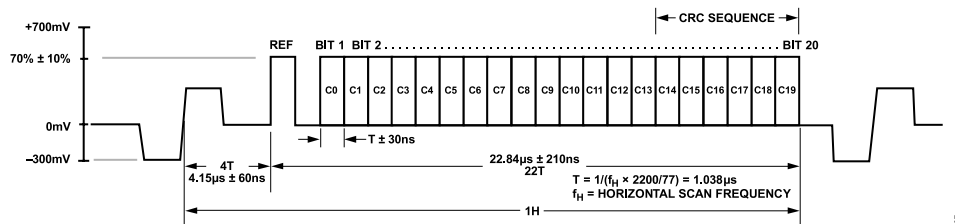
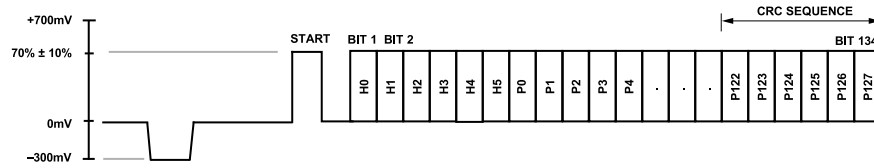

Figure 101. High Definition (1080i) CGMS Waveform

COPY GENERATION MANAGEMENT SYSTEM



NOTES
1. PLEASE REFER TO THE CEA-805-A SPECIFICATION FOR TIMING INFORMATION.

098

Figure 102. Enhanced Definition (525p) CGMS Type B Waveform

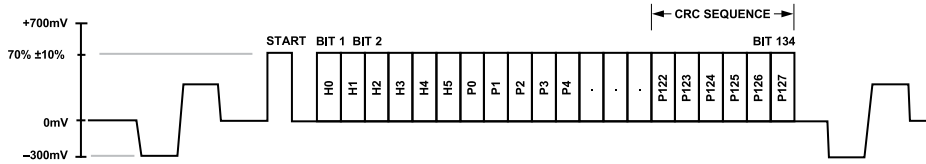

NOTES
1. PLEASE REFER TO THE CEA-805-A SPECIFICATION FOR TIMING INFORMATION.

099

Figure 103. High Definition (720p and 1080i) CGMS Type B Waveform

SD WIDE SCREEN SIGNALING

SUBADDRESS 0X99, SUBADDRESS 0X9A, SUBADDRESS 0X9B

The ADV7390/ADV7391/ADV7392/ADV7393 support wide screen signaling (WSS) con-forming to the ETSI 300 294 standard. WSS data is transmitted on Line 23. WSS data can be transmitted only when the device is configured in PAL mode. The WSS data is 14 bits long. The function of each of these bits is shown in Table

59. The WSS data is preceded by a run-in sequence and a start code (see Figure 104). The latter portion of Line 23 (after 42.5 μs from the falling edge of HSYNC) is available for the insertion of video. WSS data transmission on Line 23 can be enabled using Subaddress 0x99, Bit 7. It is possible to blank the WSS portion of Line 23 with Subaddress 0xA1, Bit 7.

Table 59. Function of WSS Bits

Bit Description	Bit Number														Setting	
	13	12	11	10	9	8	7	6	5	4	3	2	1	0		
Aspect Ratio, Format, Position												1	0	0	0	4:3, full format, N/A
												0	0	0	1	14:9, letterbox, center
												0	0	1	0	14:9, letterbox, top
												1	0	1	1	16:9, letterbox, center
												0	1	0	0	16:9, letterbox, top
												1	1	0	1	>16:9, letterbox, center
												1	1	1	0	14:9, full format, center
Mode																Camera mode
											0					Film mode
Color Encoding										0						Normal PAL
										1						Motion Adaptive ColorPlus
Helper Signals										0						Not present
										1						Present
Reserved							0									N/A
Teletext Subtitles							0									No
							1									Yes
Open Subtitles				0	0											No
				0	1											Subtitles in active image area
				1	0											Subtitles out of active image area
				1	1											Reserved
Surround Sound			0													No
			1													Yes
Copyright		0														No copyright asserted or unknown
		1														Copyright asserted
Copy Protection	0															Copying not restricted
	1															Copying restricted

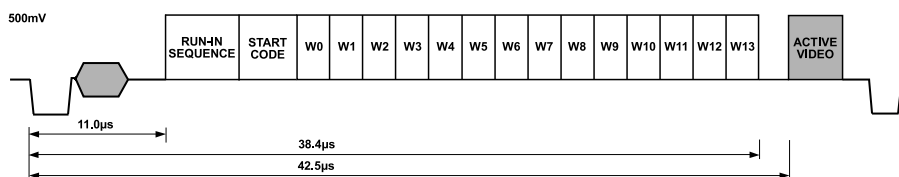

Figure 104. WSS Waveform Diagram

SD CLOSED CAPTIONING

SUBADDRESS 0X91 TO SUBADDRESS 0X94

The ADV7390/ADV7391/ADV7392/ADV7393 support closed captioning conforming to the standard television synchronizing waveform for color transmission. When enabled, closed captioning is transmitted during the blanked active line time of Line 21 of the odd fields and Line 284 of the even fields. Closed captioning can be enabled using Subaddress 0x83, Bits[6:5].

Closed captioning consists of a seven-cycle sinusoidal burst that is frequency- and phase-locked to the caption data. After the clock run-in signal, the blanking level is held for two data bits and is followed by a Logic 1 start bit. Sixteen bits of data follow the start bit. The data consists of two 8-bit bytes (seven data bits and one odd parity bit per byte). The data for these bytes is stored in SD closed captioning registers (Subaddress 0x93 to Subaddress 0x94).

The ADV7390/ADV7391/ADV7392/ADV7393 also support the extended closed captioning operation, which is active during even fields and encoded on Line 284. The data for this operation is stored in SD closed captioning registers (Subaddress 0x91 to Subaddress 0x92).

The ADV7390/ADV7391/ADV7392/ADV7393 automatically generate all clock run-in signals and timing that support closed captioning

on Line 21 and Line 284. All pixels inputs are ignored on Line 21 and Line 284 if closed captioning is enabled.

The FCC Code of Federal Regulations (CFR) Title 47 Section 15.119 and EIA-608 describe the closed captioning information for Line 21 and Line 284.

The ADV7390/ADV7391/ADV7392/ADV7393 use a single buffering method. This means that the closed captioning buffer is only 1-byte deep. Therefore, there is no frame delay in outputting the closed captioning data, unlike other 2-byte deep buffering systems. The data must be loaded one line before it is output on Line 21 and Line 284. A typical implementation of this method is to use \overline{VSYNC} to interrupt a microprocessor, which in turn loads the new data (two bytes) in every field. If no new data is required for transmission, 0s must be inserted in both data registers; this is called nulling. It is also important to load control codes, all of which are double bytes, on Line 21. Otherwise, a TV does not recognize them. If there is a message such as "Hello World" that has an odd number of characters, it is important to add a blank character at the end to make sure that the end-of-caption, 2-byte control code lands in the same field.

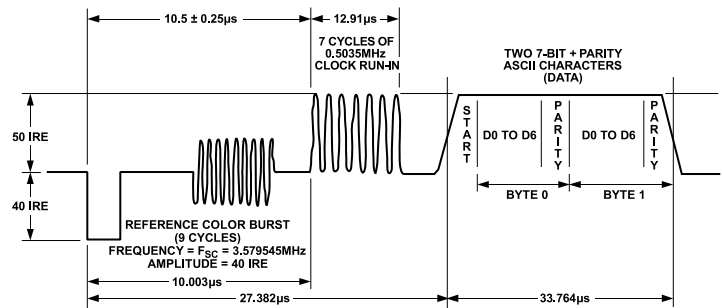

Figure 105. SD Closed Captioning Waveform, NTSC

INTERNAL TEST PATTERN GENERATION

SD TEST PATTERNS

The ADV7390/ADV7391/ADV7392/ADV7393 are able to internally generate SD color bar and black bar test patterns. For this function, a 27 MHz clock signal must be applied to the CLKIN pin.

The register settings in [Table 60](#) are used to generate an SD NTSC 75% color bar test pattern. All other registers are set as normal/default. Component YPrPb output is available on DAC 1 to DAC 3. On power-up, the subcarrier frequency registers default to the appropriate values for NTSC.

Table 60. SD NTSC Color Bar Test Pattern Register Writes

Subaddress	Setting
0x00	0x1C
0x82	0xC9
0x84	0x40

For CVBS and S-Video (Y/C) output, 0xCB instead of 0xC9 should be written to Subaddress 0x82.

For component RGB output rather than YPrPb output, 0 should be written to Subaddress 0x02, Bit 5.

To generate an SD NTSC black bar test pattern, the settings shown in [Table 60](#) should be used with an additional write of 0x24 to Subaddress 0x02.

For PAL output of either test pattern, the same settings are used except that Subaddress 0x80 is programmed to 0x11, and the subcarrier frequency (F_{SC}) registers are programmed as shown in [Table 61](#).

Table 61. PAL F_{SC} Register Writes

Subaddress	Description	Setting
0x8C	F_{SC0}	0xCB
0x8D	F_{SC1}	0x8A
0x8E	F_{SC2}	0x09
0x8F	F_{SC3}	0x2A

Note that, when programming the F_{SC} registers, the user must write the values in the sequence F_{SC0} , F_{SC1} , F_{SC2} , F_{SC3} . The full F_{SC} value to be written is only accepted after the F_{SC3} write is complete.

ED/HD TEST PATTERNS

The ADV7390/ADV7391/ADV7392/ADV7393 are able to internally generate ED/HD color bar, black bar, and hatch test patterns. For ED test patterns, a 27 MHz clock signal must be applied to the CLKIN pin. For HD test patterns, a 74.25 MHz clock signal must be applied to the CLKIN pin.

The register settings in [Table 62](#) are used to generate an ED 525p hatch test pattern. All other registers are set as normal/default. Component YPrPb output is available on DAC 1 to DAC 3. For component RGB output rather than YPrPb output, 0 should be written to Subaddress 0x02, Bit 5.

Table 62. ED 525p Hatch Test Pattern Register Writes

Subaddress	Setting
0x00	0x1C
0x01	0x10
0x31	0x05

To generate an ED 525p black bar test pattern, the settings shown in [Table 62](#) should be used with an additional write of 0x24 to Subaddress 0x02.

To generate an ED 525p flat field test pattern, the settings shown in [Table 62](#) should be used, except that 0x0D should be written to Subaddress 0x31.

The Y, Cr, and Cb levels for the hatch and flat field test patterns can be controlled using Subaddress 0x36, Subaddress 0x37, and Subaddress 0x38, respectively.

For ED/HD standards other than 525p, the settings shown in [Table 62](#) (and subsequent comments) are used, except that Subaddress 0x30, Bits[7:3] are updated as appropriate.

SD TIMING

MODE 0 (CCIR-656)—SUBORDINATE OPTION (SUBADDRESS 0X8A = X X X X X 0 0 0)

The ADV7390/ADV7391/ADV7392/ADV7393 are controlled by the SAV (start of active video) and EAV (end of active video) time codes embedded in the pixel data. All timing information is transmitted using a 4-byte synchronization pattern. A synchronization pattern is sent immediately before and after each line during active picture and retrace. If the \overline{VSYNC} and \overline{HSYNC} pins are not used, they should be tied to V_{DD_IO} when using this mode.

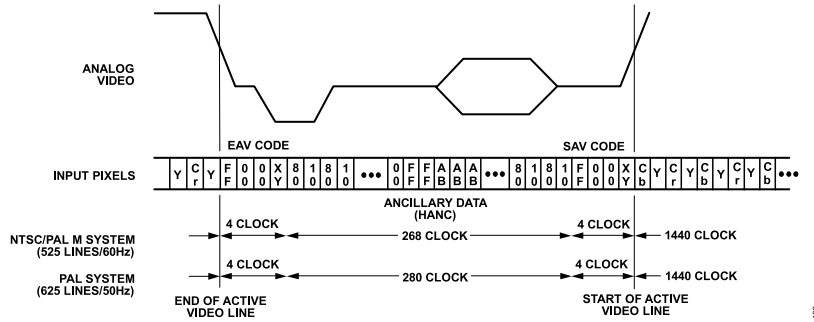

Figure 106. SD Timing Mode 0, Subordinate Option

MODE 0 (CCIR-656)—MAIN OPTION (SUBADDRESS 0X8A = X X X X X 0 0 1)

The ADV7390/ADV7391/ADV7392/ADV7393 generate H and F signals required for the SAV and EAV time codes in the CCIR-656 standard. The H bit is output on \overline{HSYNC} and the F bit is output on \overline{VSYNC} .

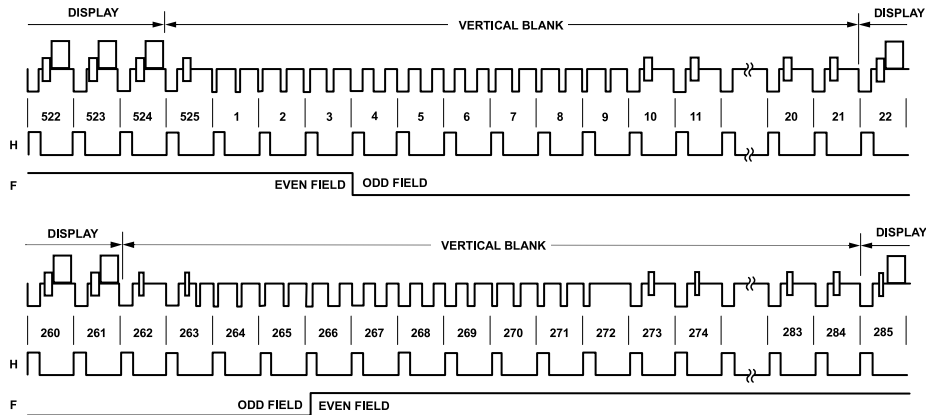

Figure 107. SD Timing Mode 0, Main Option, NTSC

SD TIMING

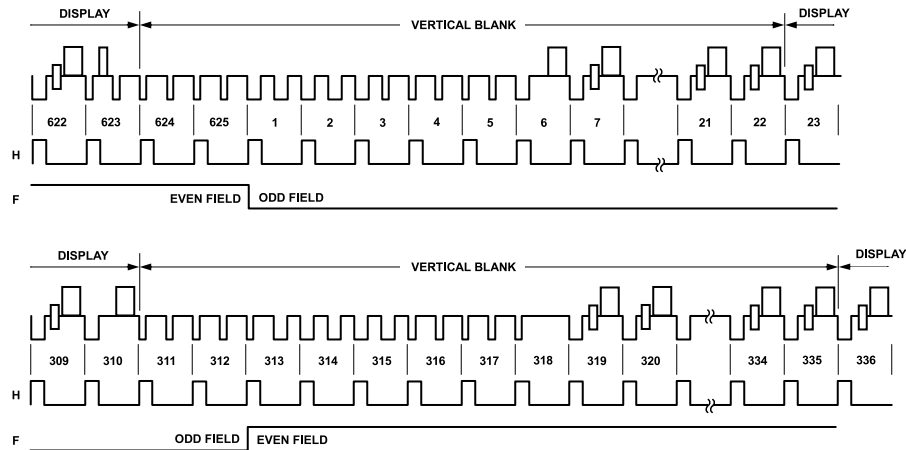

Figure 108. SD Timing Mode 0, Main Option, PAL

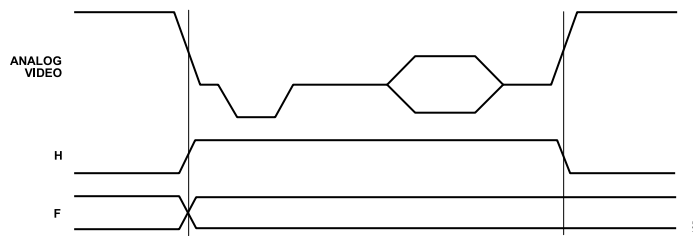

Figure 109. SD Timing Mode 0, Main Option, Data Transitions

MODE 1—SUBORDINATE OPTION (SUBADDRESS 0X8A = X X X X 0 1 0)

In this mode, the ADV7390/ADV7391/ADV7392/ADV7393 accept horizontal synchronization and odd/even field signals. When $\overline{\text{HSYNC}}$ is low, a transition of the field input indicates a new frame, that is, vertical retrace. $\overline{\text{HSYNC}}$ and FIELD are input on the $\overline{\text{HSYNC}}$ and $\overline{\text{VSYNC}}$ pins, respectively.

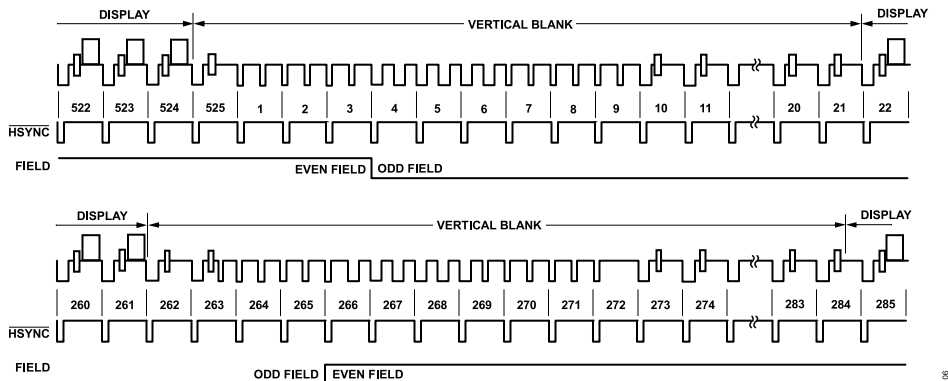

Figure 110. SD Timing Mode 1, Subordinate Option, NTSC

SD TIMING

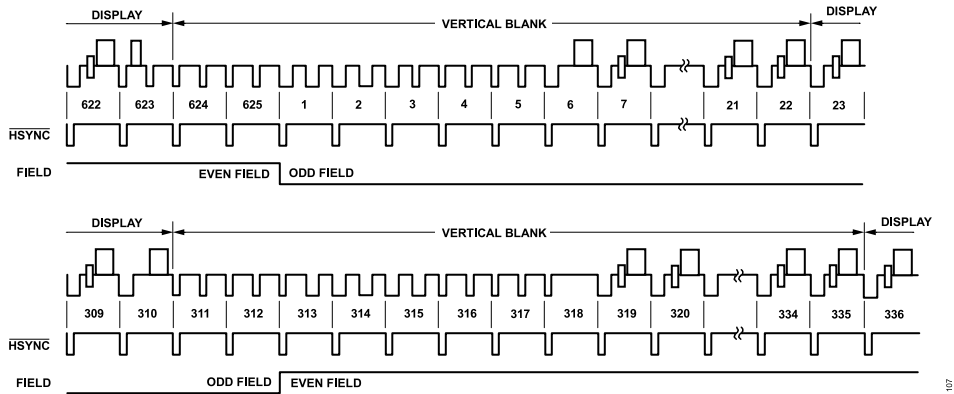

Figure 111. SD Timing Mode 1, Subordinate Option, PAL

MODE 1—MAIN OPTION (SUBADDRESS 0X8A = X X X X 0 1 1)

In this mode, the ADV7390/ADV7391/ADV7392/ADV7393 can generate horizontal synchronization and odd/even field signals. When $\overline{\text{HSYNC}}$ is low, a transition of the field input indicates a new frame, that is, vertical retrace. The ADV7390/ADV7391/ADV7392/ADV7393 automatically blank all normally blank lines as required by the CCIR-624 standard. Pixel data is latched on the rising clock edge following the timing signal transitions. $\overline{\text{HSYNC}}$ and FIELD are output on the $\overline{\text{HSYNC}}$ and $\overline{\text{VSYNC}}$ pins, respectively.

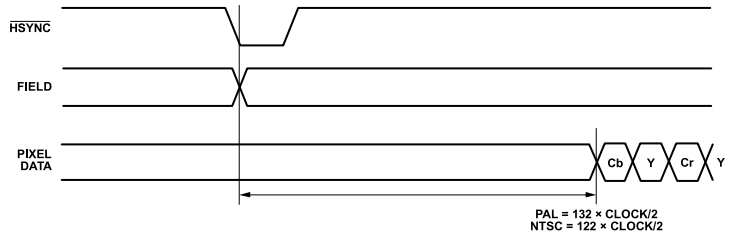

Figure 112. SD Timing Mode 1, Odd/Even Field Transitions (Main/Subordinate)

MODE 2— SUBORDINATE OPTION (SUBADDRESS 0X8A = X X X X X 1 0 0)

In this mode, the ADV7390/ADV7391/ADV7392/ADV7393 accept horizontal and vertical synchronization signals. A coincident low transition of both $\overline{\text{HSYNC}}$ and $\overline{\text{VSYNC}}$ inputs indicates the start of an odd field. A $\overline{\text{VSYNC}}$ low transition when $\overline{\text{HSYNC}}$ is high indicates the start of an even field. The ADV7390/ADV7391/ADV7392/ADV7393 automatically blank all normally blank lines as required by the CCIR-624 standard. $\overline{\text{HSYNC}}$ and $\overline{\text{VSYNC}}$ are input on the $\overline{\text{HSYNC}}$ and $\overline{\text{VSYNC}}$ pins, respectively.

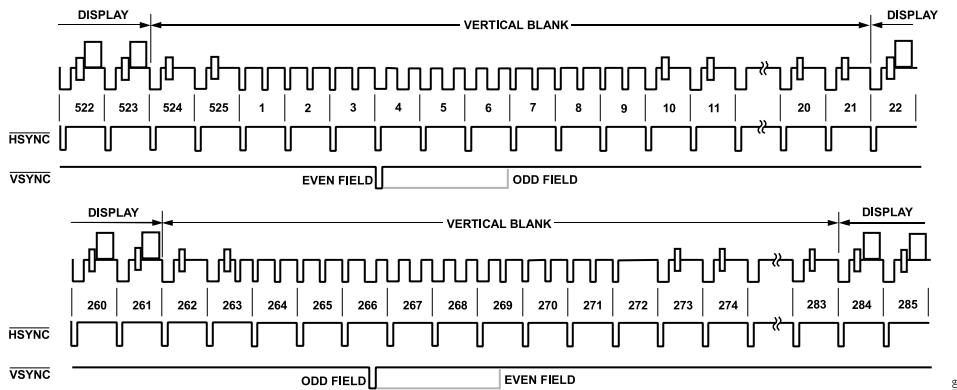

Figure 113. SD Timing Mode 2, Subordinate Option, NTSC

SD TIMING

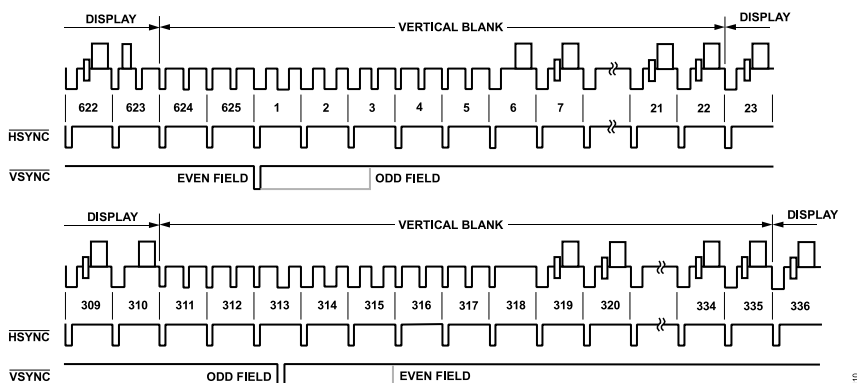

Figure 114. SD Timing Mode 2, Subordinate Option, PAL

MODE 2—MAIN OPTION (SUBADDRESS 0X8A = X X X X X 1 0 1)

In this mode, the ADV7390/ADV7391/ADV7392/ADV7393 can generate horizontal and vertical synchronization signals. A coincident low transition of both HSYNC and VSYNC inputs indicates the start of an odd field. A VSYNC low transition when HSYNC is high indicates the start of an even field. The ADV7390/ADV7391/ADV7392/ADV7393 automatically blank all normally blank lines as required by the CCIR-624 standard. HSYNC and VSYNC are output on the HSYNC and VSYNC pins, respectively.

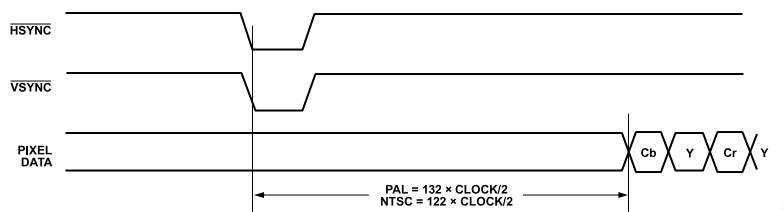

Figure 115. SD Timing Mode 2, Even-to-Odd Field Transition (Main/Subordinate)

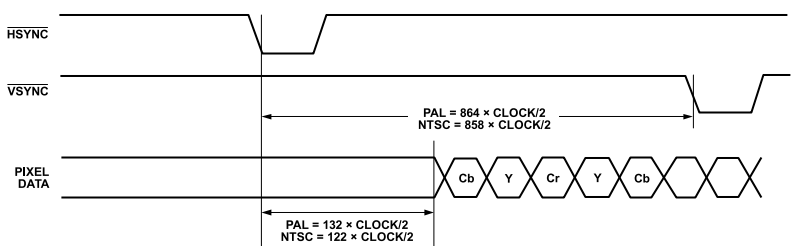

Figure 116. SD Timing Mode 2, Odd-to-Even Field Transition (Main/Subordinate)

MODE 3—MAIN/SUBORDINATE OPTION (SUBADDRESS 0X8A = X X X X X 1 1 0 OR X X X X X 1 1 1)

In this mode, the ADV7390/ADV7391/ADV7392/ADV7393 accept or generates horizontal synchronization and odd/even field signals. When HSYNC is high, a transition of the field input indicates a new frame, that is, vertical retrace. The ADV7390/ADV7391/ADV7392/ADV7393 automatically blank all normally blank lines as required by the CCIR-624 standard. HSYNC and VSYNC are output in main mode and input in subordinate mode on the HSYNC and VSYNC pins, respectively.

SD TIMING

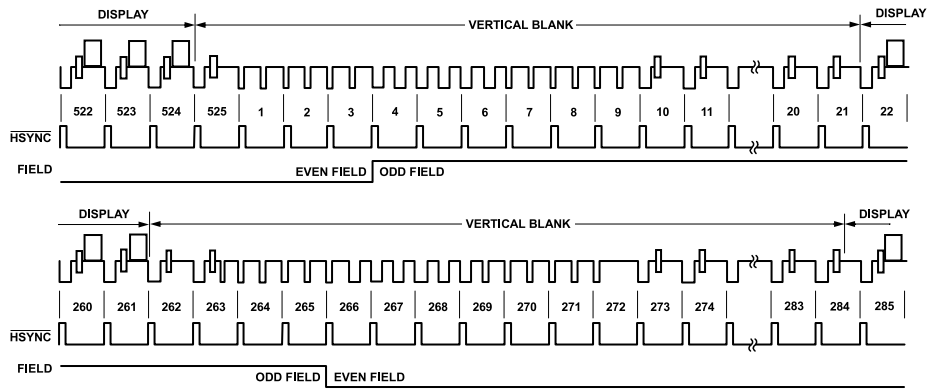

Figure 117. SD Timing Mode 3, NTSC

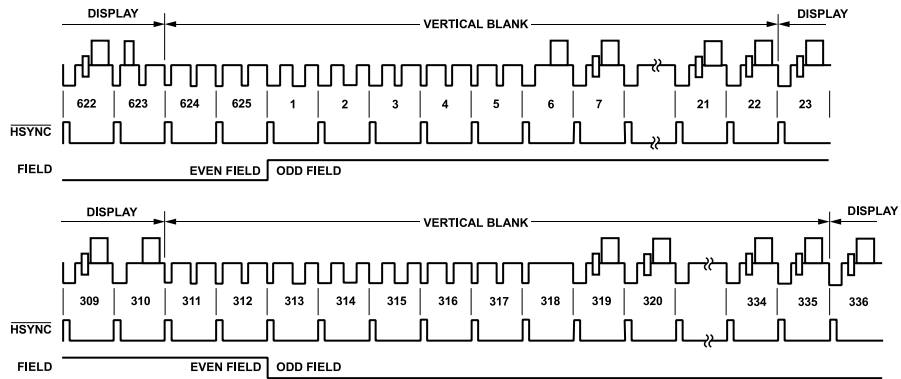

Figure 118. SD Timing Mode 3, PAL

HD TIMING

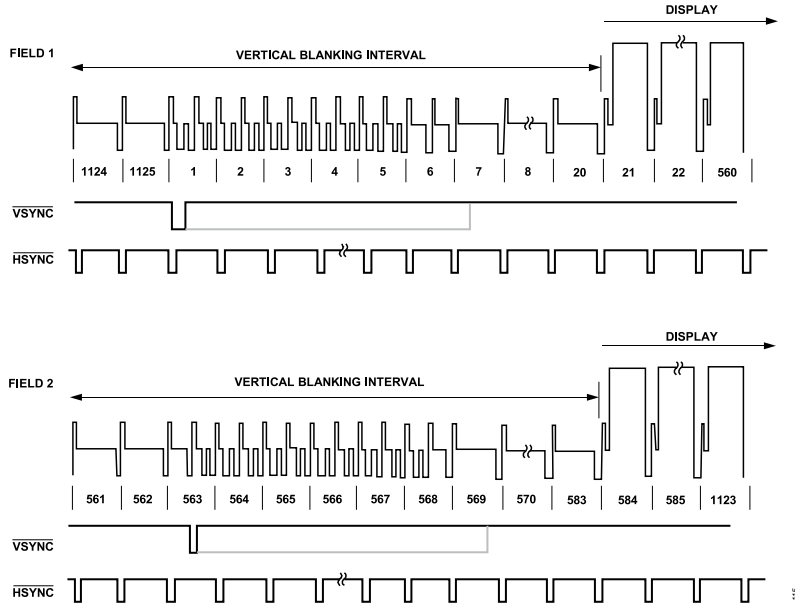

Figure 119. 1080i HSYNC and VSYNC Input Timing

VIDEO OUTPUT LEVELS

SD YPRPB OUTPUT LEVELS—SMPTE/EBU N10

Pattern: 100% Color Bars

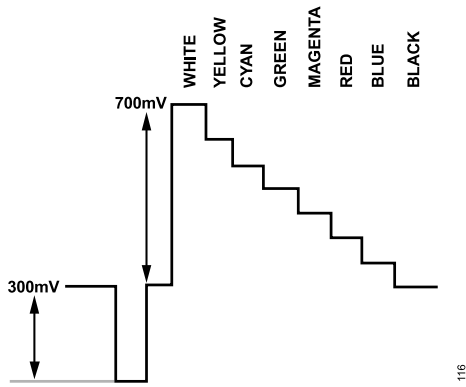

Figure 120. Y Levels—NTSC

116

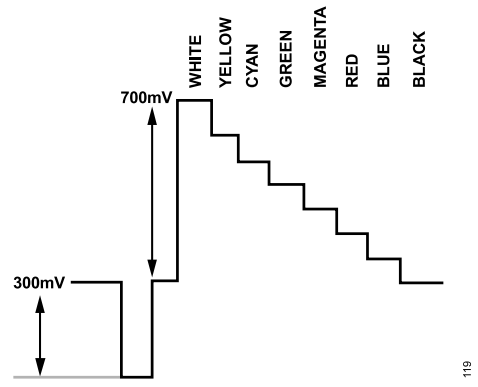

Figure 123. Y Levels—PAL

119

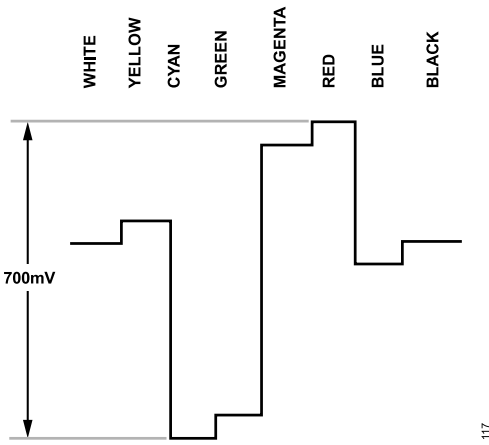

Figure 121. Pr Levels—NTSC

117

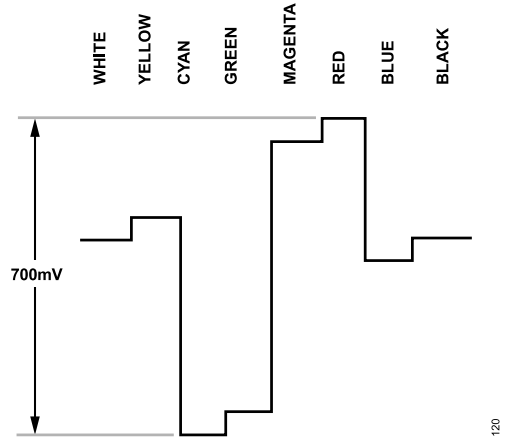

Figure 124. Pr Levels—PAL

120

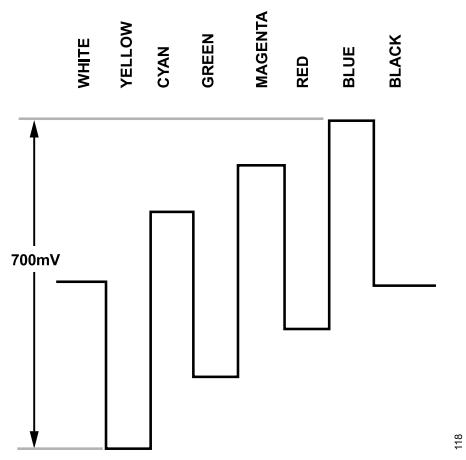

Figure 122. Pb Levels—NTSC

118

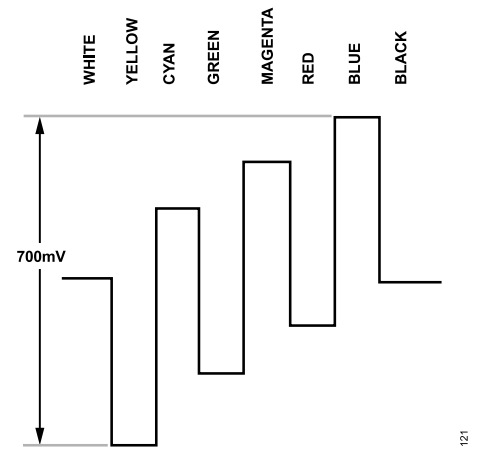

Figure 125. Pb Levels—PAL

121

VIDEO OUTPUT LEVELS

ED/HD YPRPB OUTPUT LEVELS

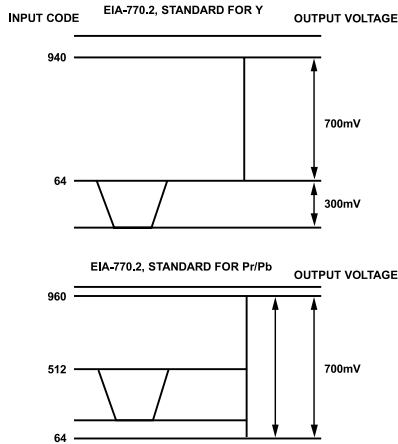

Figure 126. EIA-770.2 Standard Output Signals (525p/625p)

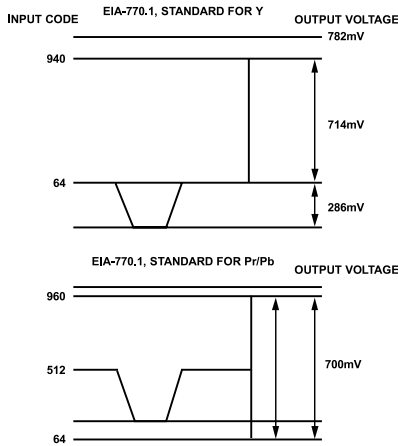

Figure 127. EIA-770.1 Standard Output Signals (525p/625p)

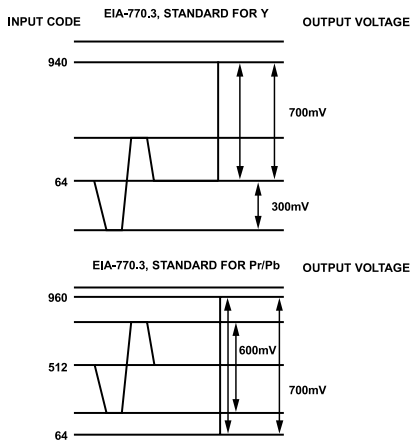

Figure 128. EIA-770.3 Standard Output Signals (1080i/720p)

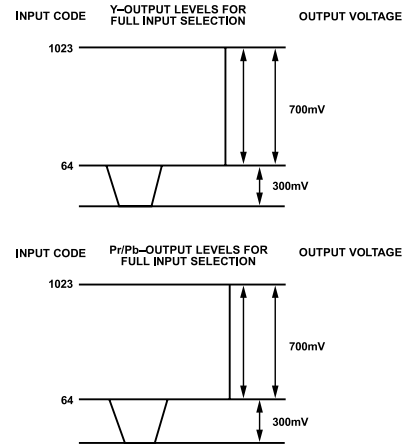

Figure 129. Output Levels for Full Input Selection

VIDEO OUTPUT LEVELS

SD/ED/HD RGB OUTPUT LEVELS

Pattern: 100%/75% Color Bars

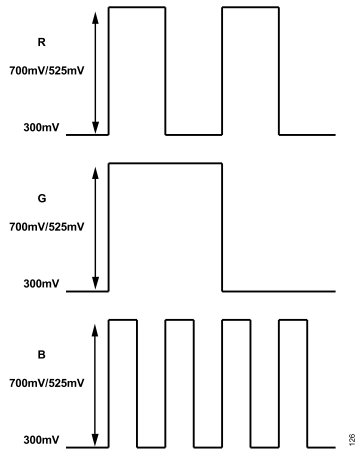

Figure 130. SD/ED RGB Output Levels—RGB Sync Disabled

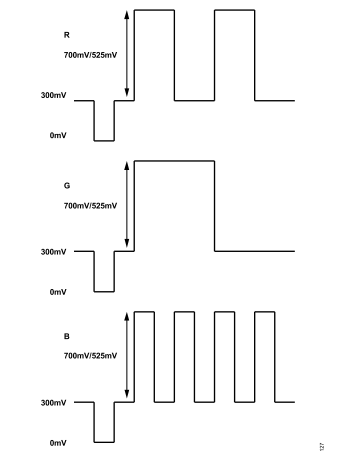

Figure 131. SD/ED RGB Output Levels—RGB Sync Enabled

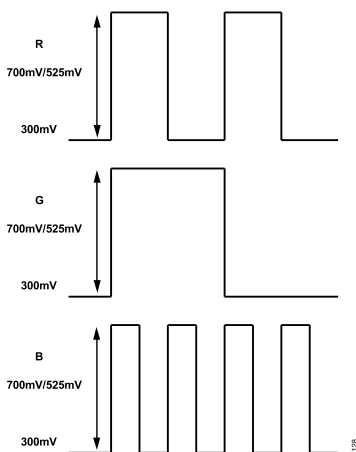

Figure 132. HD RGB Output Levels—RGB Sync Disabled

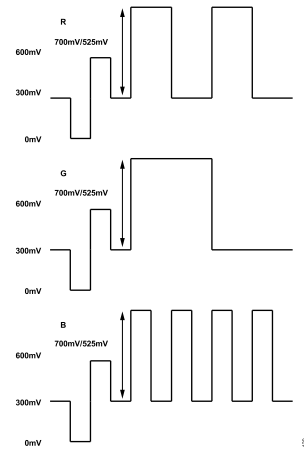
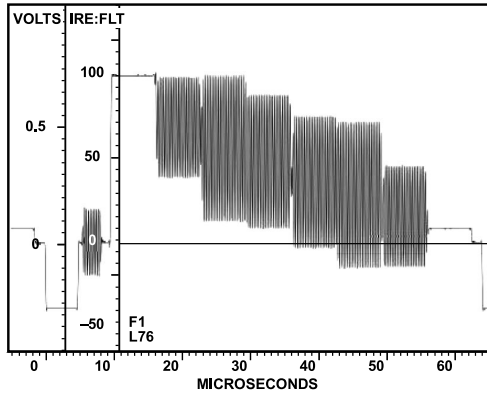

Figure 133. HD RGB Output Levels—RGB Sync Enabled

VIDEO OUTPUT LEVELS

SD OUTPUT PLOTS



APL = 44.5%
 525 LINE NTSC
 SLOW CLAMP TO 0.00V AT 6.72µs
 PRECISION MODE OFF
 SYNCHRONOUS SYNC = A
 FRAMES SELECTED 1, 2

Figure 134. NTSC Color Bars (75%)

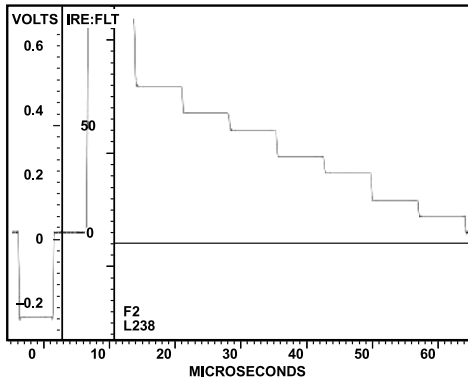

NOISE REDUCTION: 15.05dB
 APL = 44.3%
 525 LINE NTSC NO FILTERING
 SLOW CLAMP TO 0.00V AT 6.72µs
 PRECISION MODE OFF
 SYNCHRONOUS SYNC = SOURCE
 FRAMES SELECTED 1, 2

Figure 135. NTSC Luma

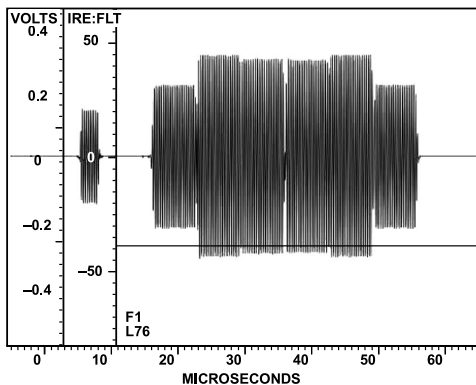

NOISE REDUCTION: 15.05dB
 APL NEEDS SYNC SOURCE.
 525 LINE NTSC NO FILTERING
 SLOW CLAMP TO 0.00 AT 6.72µs
 PRECISION MODE OFF
 SYNCHRONOUS SYNC = B
 FRAMES SELECTED 1, 2

Figure 136. NTSC Chroma

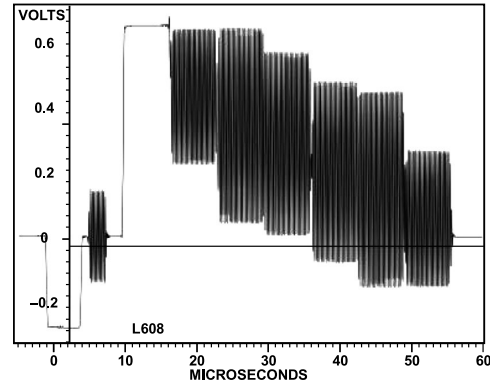

NOISE REDUCTION: 0.00dB
 APL = 39.1%
 625 LINE NTSC NO FILTERING
 SLOW CLAMP TO 0.00 AT 6.72µs
 PRECISION MODE OFF
 SYNCHRONOUS SOUND-IN-SYNC OFF
 FRAMES SELECTED 1, 2, 3, 4

Figure 137. PAL Color Bars (75%)

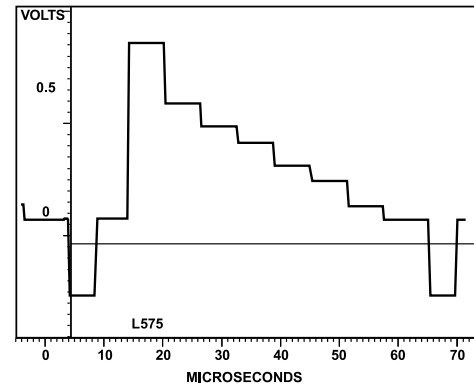

APL NEEDS SYNC SOURCE. NO BUNCH SIGNAL
 625 LINE PAL NO FILTERING
 SLOW CLAMP TO 0.00 AT 6.72µs
 PRECISION MODE OFF
 SYNCHRONOUS SOUND-IN-SYNC OFF
 FRAMES SELECTED 1

Figure 138. PAL Luma

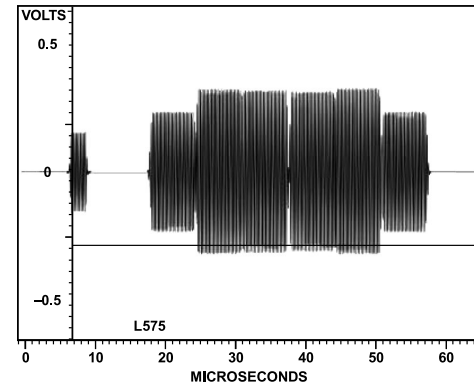

APL NEEDS SYNC SOURCE. NO BUNCH SIGNAL
 625 LINE PAL NO FILTERING
 SLOW CLAMP TO 0.00 AT 6.72µs
 PRECISION MODE OFF
 SYNCHRONOUS SOUND-IN-SYNC OFF
 FRAMES SELECTED 1

Figure 139. PAL Chroma

VIDEO STANDARDS

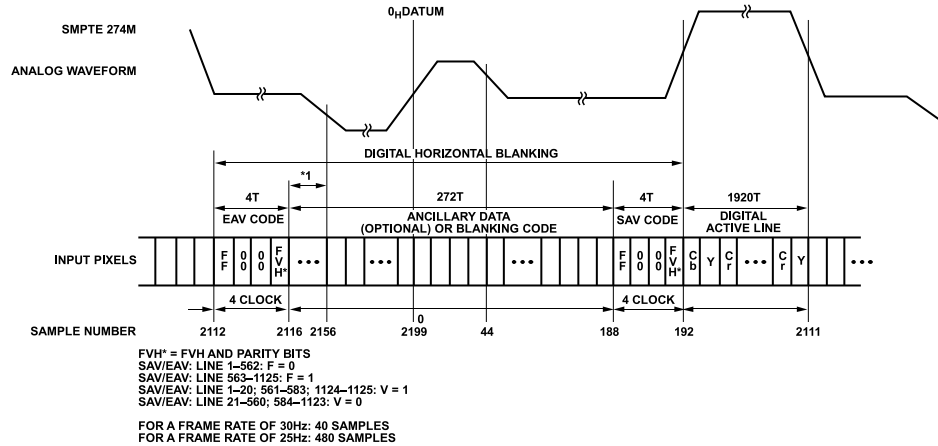

Figure 140. EAV/SAV Input Data Timing Diagram (SMPTE 274M)

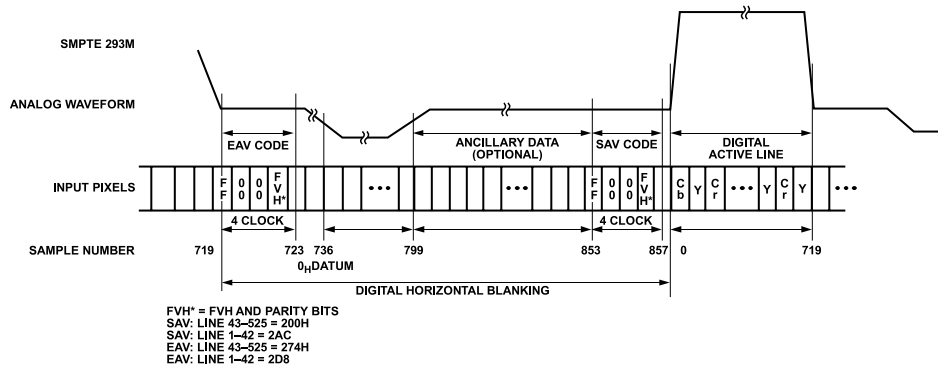

Figure 141. EAV/SAV Input Data Timing Diagram (SMPTE 293M)

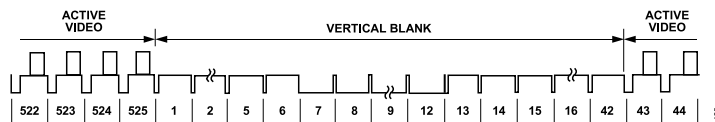

Figure 142. SMPTE 293M (525p)

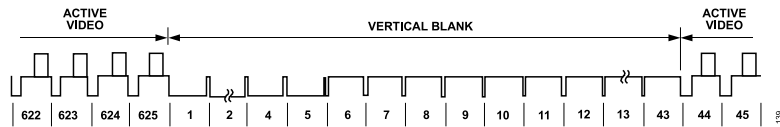

Figure 143. ITU-R BT.1358 (625p)

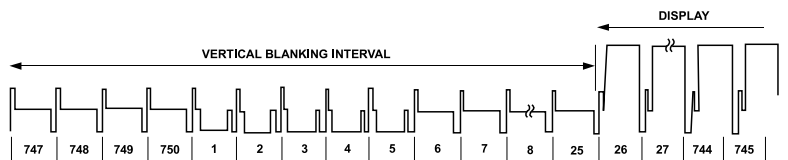

Figure 144. SMPTE 296M (720p)

VIDEO STANDARDS

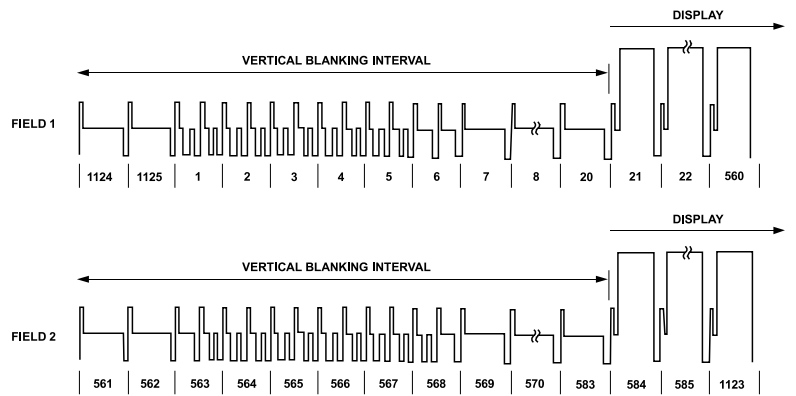

Figure 145. SMPTE 274M (1080i)

CONFIGURATION SCRIPTS

The scripts listed in the following pages can be used to configure the ADV7390/ADV7391/ADV7392/ADV7393 for basic operation. Certain features are enabled by default. If required for a specific application, additional features can be enabled. [Table 63](#) lists the scripts available for SD modes of operation. Similarly, [Table 98](#) and [Table 115](#) list the scripts available for ED and HD modes of

STANDARD DEFINITION

operation, respectively. For all scripts, only the necessary register writes are included. All other registers are assumed to have their default values. The WLCSP package supports only scripts in [Table 65](#), [Table 79](#), [Table 82](#), and [Table 96](#). In those scripts, Subaddress 0x00 must be set to 0x10.

Table 63. SD Configuration Scripts

Input Format	Input Data Width ¹	Synchronization Format	Input Color Space	Output Color Space	Table Number
525i (NTSC)	8-bit SDR	EAV/SAV	YCrCb	YPrPb	Table 64
525i (NTSC)	8-bit SDR	EAV/SAV	YCrCb	CVBS/Y-C (S-Video)	Table 65
525i (NTSC)	8-bit SDR	$\overline{\text{HSYNC}}/\overline{\text{VSYNC}}$	YCrCb	YPrPb	Table 66
525i (NTSC)	8-bit SDR	EAV/SAV	YCrCb	RGB	Table 67
525i (NTSC)	8-bit SDR	$\overline{\text{HSYNC}}/\overline{\text{VSYNC}}$	YCrCb	RGB	Table 68
525i (NTSC)	10-bit SDR	EAV/SAV	YCrCb	YPrPb	Table 69
525i (NTSC)	10-bit SDR	$\overline{\text{HSYNC}}/\overline{\text{VSYNC}}$	YCrCb	YPrPb	Table 70
525i (NTSC)	10-bit SDR	$\overline{\text{HSYNC}}/\overline{\text{VSYNC}}$	YCrCb	CVBS/Y-C (S-Video)	Table 71
525i (NTSC)	10-bit SDR	EAV/SAV	YCrCb	RGB	Table 72
525i (NTSC)	10-bit SDR	$\overline{\text{HSYNC}}/\overline{\text{VSYNC}}$	YCrCb	RGB	Table 73
525i (NTSC)	16-bit SDR	$\overline{\text{HSYNC}}/\overline{\text{VSYNC}}$	YCrCb	YPrPb	Table 74
525i (NTSC)	16-bit SDR	$\overline{\text{HSYNC}}/\overline{\text{VSYNC}}$	YCrCb	RGB	Table 75
525i (NTSC)	16-bit SDR	$\overline{\text{HSYNC}}/\overline{\text{VSYNC}}$	RGB	YPrPb	Table 76
525i (NTSC)	16-bit SDR	$\overline{\text{HSYNC}}/\overline{\text{VSYNC}}$	RGB	CVBS/Y-C (S-Video)	Table 77
525i (NTSC)	16-bit SDR	$\overline{\text{HSYNC}}/\overline{\text{VSYNC}}$	RGB	RGB	Table 78
NTSC Sq. Pixel	8-bit SDR	EAV/SAV	YCrCb	CVBS/Y-C (S-Video)	Table 79
NTSC Sq. Pixel	16-bit SDR	$\overline{\text{HSYNC}}/\overline{\text{VSYNC}}$	RGB	CVBS/Y-C (S-Video)	Table 80
625i (PAL)	8-bit SDR	EAV/SAV	YCrCb	YPrPb	Table 81
625i (PAL)	8-bit SDR	EAV/SAV	YCrCb	CVBS/Y-C (S-Video)	Table 82
625i (PAL)	8-bit SDR	$\overline{\text{HSYNC}}/\overline{\text{VSYNC}}$	YCrCb	YPrPb	Table 83
625i (PAL)	8-bit SDR	EAV/SAV	YCrCb	RGB	Table 84
625i (PAL)	8-bit SDR	$\overline{\text{HSYNC}}/\overline{\text{VSYNC}}$	YCrCb	RGB	Table 85
625i (PAL)	10-bit SDR	EAV/SAV	YCrCb	YPrPb	Table 86
625i (PAL)	10-bit SDR	$\overline{\text{HSYNC}}/\overline{\text{VSYNC}}$	YCrCb	YPrPb	Table 87
625i (PAL)	10-bit SDR	$\overline{\text{HSYNC}}/\overline{\text{VSYNC}}$	YCrCb	CVBS/Y-C (S-Video)	Table 88
625i (PAL)	10-bit SDR	EAV/SAV	YCrCb	RGB	Table 89
625i (PAL)	10-bit SDR	$\overline{\text{HSYNC}}/\overline{\text{VSYNC}}$	YCrCb	RGB	Table 90
625i (PAL)	16-bit SDR	$\overline{\text{HSYNC}}/\overline{\text{VSYNC}}$	YCrCb	YPrPb	Table 91
625i (PAL)	16-bit SDR	$\overline{\text{HSYNC}}/\overline{\text{VSYNC}}$	YCrCb	RGB	Table 92
625i (PAL)	16-bit SDR	$\overline{\text{HSYNC}}/\overline{\text{VSYNC}}$	RGB	YPrPb	Table 93
625i (PAL)	16-bit SDR	$\overline{\text{HSYNC}}/\overline{\text{VSYNC}}$	RGB	CVBS/Y-C (S-Video)	Table 94
625i (PAL)	16-bit SDR	$\overline{\text{HSYNC}}/\overline{\text{VSYNC}}$	RGB	RGB	Table 95
PAL Sq. Pixel	8-bit SDR	EAV/SAV	YCrCb	CVBS/Y-C (S-Video)	Table 96
PAL Sq. Pixel	16-bit SDR	$\overline{\text{HSYNC}}/\overline{\text{VSYNC}}$	RGB	CVBS/Y-C (S-Video)	Table 97

¹ SDR = single data rate.

CONFIGURATION SCRIPTS

Table 64. 8-Bit 525i YCrCb In (EAV/SAV), YPrPb Out

Subaddress	Setting	Description
0x17	0x02	Software reset.
0x00	0x1C	All DACs enabled. PLL enabled (16×).
0x01	0x00	SD input mode.
0x80	0x10	NTSC standard. SSAF luma filter enabled. 1.3 MHz chroma filter enabled.
0x82	0xC9	Pixel data valid. YPrPb out. SSAF PrPb filter enabled. Active video edge control enabled. Pedestal enabled.

Table 65. 8-Bit 525i YCrCb In (EAV/SAV), CVBS/Y-C Out

Subaddress	Setting	Description
0x17	0x02	Software reset
0x00	0x1C	All DACs enabled. PLL enabled (16×).
	0x10	WLCSP required.
0x01	0x00	SD input mode.
0x80	0x10	NTSC standard. SSAF luma filter enabled. 1.3 MHz chroma filter enabled.
0x82	0xCB	Pixel data valid. CVBS/Y-C (S-Video) out. SSAF PrPb filter enabled. Active video edge control enabled. Pedestal enabled.

Table 66. 8-Bit 525i YCrCb In, YPrPb Out

Subaddress	Setting	Description
0x17	0x02	Software reset.
0x00	0x1C	All DACs enabled. PLL enabled (16×).
0x01	0x00	SD input mode.
0x80	0x10	NTSC standard. SSAF luma filter enabled. 1.3 MHz chroma filter enabled.
0x82	0xC9	Pixel data valid. YPrPb out. SSAF PrPb filter enabled. Active video edge control enabled. Pedestal enabled.
0x8A	0x0C	Timing Mode 2 (subordinate). HSYNC/VSYNC synchronization.

Table 67. 8-Bit 525i YCrCb In (EAV/SAV), RGB Out

Subaddress	Setting	Description
0x17	0x02	Software reset.
0x00	0x1C	All DACs enabled. PLL enabled (16×).
0x01	0x00	SD input mode.
0x02	0x10	RGB output enabled. RGB output sync enabled.
0x80	0x10	NTSC standard. SSAF luma filter enabled. 1.3 MHz chroma filter enabled.
0x82	0xC9	Pixel data valid. RGB out. SSAF PrPb filter enabled. Active video edge control enabled. Pedestal enabled.

Table 68. 8-Bit 525i YCrCb In, RGB Out

Subaddress	Setting	Description
0x17	0x02	Software reset.
0x00	0x1C	All DACs enabled. PLL enabled (16×).
0x01	0x00	SD input mode.

Table 68. 8-Bit 525i YCrCb In, RGB Out (Continued)

Subaddress	Setting	Description
0x02	0x10	RGB output enabled. RGB output sync enabled.
0x80	0x10	NTSC standard. SSAF luma filter enabled. 1.3 MHz chroma filter enabled.
0x82	0xC9	Pixel data valid. RGB out. SSAF PrPb filter enabled. Active video edge control enabled. Pedestal enabled.
0x8A	0x0C	Timing Mode 2 (subordinate). HSYNC/VSYNC synchronization.

Table 69. 10-Bit 525i YCrCb In (EAV/SAV), YPrPb Out

Subaddress	Setting	Description
0x17	0x02	Software reset.
0x00	0x1C	All DACs enabled. PLL enabled (16×).
0x01	0x00	SD input mode.
0x80	0x10	NTSC standard. SSAF luma filter enabled. 1.3 MHz chroma filter enabled.
0x82	0xC9	Pixel data valid. YPrPb out. SSAF PrPb filter enabled. Active video edge control enabled. Pedestal enabled.
0x88	0x10	10-bit input enabled.

Table 70. 10-Bit 525i YCrCb In, YPrPb Out

Subaddress	Setting	Description
0x17	0x02	Software reset.
0x00	0x1C	All DACs enabled. PLL enabled (16×).
0x01	0x00	SD input mode.
0x80	0x10	NTSC standard. SSAF luma filter enabled. 1.3 MHz chroma filter enabled.
0x82	0xC9	Pixel data valid. YPrPb out. SSAF PrPb filter enabled. Active video edge control enabled. Pedestal enabled.
0x88	0x10	10-bit input enabled.
0x8A	0x0C	Timing Mode 2 (subordinate). HSYNC/VSYNC synchronization.

Table 71. 10-Bit 525i YCrCb In, CVBS/Y-C Out

Subaddress	Setting	Description
0x17	0x02	Software reset.
0x00	0x1C	All DACs enabled. PLL enabled (16×).
0x01	0x00	SD input mode.
0x80	0x10	NTSC standard. SSAF luma filter enabled. 1.3 MHz chroma filter enabled.
0x82	0xCB	Pixel data valid. CVBS/Y-C (S-Video) out. SSAF PrPb filter enabled. Active video edge control enabled. Pedestal enabled.
0x88	0x10	10-bit input enabled.
0x8A	0x0C	Timing Mode 2 (subordinate). HSYNC/VSYNC synchronization.

Table 72. 10-Bit 525i YCrCb In (EAV/SAV), RGB Out

Subaddress	Setting	Description
0x17	0x02	Software reset.

CONFIGURATION SCRIPTS

Table 72. 10-Bit 525i YCrCb In (EAV/SAV), RGB Out (Continued)

Subaddress	Setting	Description
0x00	0x1C	All DACs enabled. PLL enabled (16×).
0x01	0x00	SD input mode.
0x02	0x10	RGB output enabled. RGB output sync enabled.
0x80	0x10	NTSC standard. SSAF luma filter enabled. 1.3 MHz chroma filter enabled.
0x82	0xC9	Pixel data valid. RGB out. SSAF PrPb filter enabled. Active video edge control enabled. Pedestal enabled.
0x88	0x10	10-bit input enabled.

Table 73. 10-Bit 525i YCrCb In, RGB Out

Subaddress	Setting	Description
0x17	0x02	Software reset.
0x00	0x1C	All DACs enabled. PLL enabled (16×).
0x01	0x00	SD input mode.
0x02	0x10	RGB output enabled. RGB output sync enabled.
0x80	0x10	NTSC standard. SSAF luma filter enabled. 1.3 MHz chroma filter enabled.
0x82	0xC9	Pixel data valid. RGB out. SSAF PrPb filter enabled. Active video edge control enabled. Pedestal enabled.
0x88	0x10	10-bit input enabled.
0x8A	0x0C	Timing Mode 2 (subordinate). HSYNC/VSYNC synchronization.

Table 74. 16-Bit 525i YCrCb In, YPrPb Out

Subaddress	Setting	Description
0x17	0x02	Software reset.
0x00	0x1C	All DACs enabled. PLL enabled (16×).
0x01	0x00	SD input mode.
0x80	0x10	NTSC standard. SSAF luma filter enabled. 1.3 MHz chroma filter enabled.
0x82	0xC9	Pixel data valid. YPrPb out. SSAF PrPb filter enabled. Active video edge control enabled. Pedestal enabled.
0x88	0x10	16-bit RGB input enabled.
0x8A	0x0C	Timing Mode 2 (subordinate). HSYNC/VSYNC synchronization.

Table 75. 16-Bit 525i YCrCb In, RGB Out

Subaddress	Setting	Description
0x17	0x02	Software reset.
0x00	0x1C	All DACs enabled. PLL enabled (16×).
0x01	0x00	SD input mode.
0x02	0x10	RGB output enabled. RGB output sync enabled.
0x80	0x10	NTSC standard. SSAF luma filter enabled. 1.3 MHz chroma filter enabled.
0x82	0xC9	Pixel data valid. RGB out. SSAF PrPb filter enabled. Active video edge control enabled. Pedestal enabled.
0x88	0x10	16-bit RGB input enabled.

Table 75. 16-Bit 525i YCrCb In, RGB Out (Continued)

Subaddress	Setting	Description
0x8A	0x0C	Timing Mode 2 (subordinate). HSYNC/VSYNC synchronization.

Table 76. 16-Bit 525i RGB In, YPrPb Out

Subaddress	Setting	Description
0x17	0x02	Software reset.
0x00	0x1C	All DACs enabled. PLL enabled (16×).
0x01	0x00	SD input mode.
0x80	0x10	NTSC standard. SSAF luma filter enabled. 1.3 MHz chroma filter enabled.
0x82	0xC9	Pixel data valid. YPrPb out. SSAF PrPb filter enabled. Active video edge control enabled. Pedestal enabled.
0x87	0x80	RGB input enabled.
0x88	0x10	16-bit RGB input enabled.
0x8A	0x0C	Timing Mode 2 (subordinate). HSYNC/VSYNC synchronization.

Table 77. 16-Bit 525i RGB In, CVBS/Y-C Out

Subaddress	Setting	Description
0x17	0x02	Software reset.
0x00	0x1C	All DACs enabled. PLL enabled (16×).
0x01	0x00	SD input mode.
0x80	0x10	NTSC standard. SSAF luma filter enabled. 1.3 MHz chroma filter enabled.
0x82	0xCB	Pixel data valid. CVBS/Y-C (S-Video) out. SSAF PrPb filter enabled. Active video edge control enabled. Pedestal enabled.
0x87	0x80	RGB input enabled.
0x88	0x10	16-bit RGB input enabled.
0x8A	0x0C	Timing Mode 2 (subordinate). HSYNC/VSYNC synchronization.

Table 78. 16-Bit 525i RGB In, RGB Out

Subaddress	Setting	Description
0x17	0x02	Software reset.
0x00	0x1C	All DACs enabled. PLL enabled (16×).
0x01	0x00	SD input mode.
0x02	0x10	RGB output enabled. RGB output sync enabled.
0x80	0x10	NTSC standard. SSAF luma filter enabled. 1.3 MHz chroma filter enabled.
0x82	0xC9	Pixel data valid. RGB out. SSAF PrPb filter enabled. Active video edge control enabled. Pedestal enabled.
0x87	0x80	RGB input enabled.
0x88	0x10	16-bit RGB input enabled.
0x8A	0x0C	Timing Mode 2 (subordinate). HSYNC/VSYNC synchronization.

CONFIGURATION SCRIPTS

Table 79. 8-Bit NTSC Square Pixel YCrCb In (EAV/SAV), CVBS/Y-C Out

Subaddress	Setting	Description
0x17	0x02	Software reset.
0x00	0x1C	All DACs enabled. PLL enabled (16×).
	0x10	WLCSP required.
0x01	0x00	SD input mode.
0x80	0x10	NTSC standard. SSAF luma filter enabled. 1.3 MHz chroma filter enabled.
0x82	0xDB	Pixel data valid. CVBS/Y-C (S-Video) out. SSAF PrPb filter enabled. Active video edge control enabled. Pedestal enabled. Square pixel mode enabled.
0x8C	0x55	Subcarrier frequency register values for CVBS and/or S-Video (Y-C) output in NTSC square pixel mode (24.5454 MHz input clock).
0x8D	0x55	
0x8E	0x55	
0x8F	0x25	

Table 80. 16-Bit NTSC Square Pixel RGB In, CVBS/Y-C Out

Subaddress	Setting	Description
0x17	0x02	Software reset.
0x00	0x1C	All DACs enabled. PLL enabled (16×).
0x01	0x00	SD input mode.
0x80	0x10	NTSC standard. SSAF luma filter enabled. 1.3 MHz chroma filter enabled.
0x82	0xDB	Pixel data valid. CVBS/Y-C (S-Video) out. SSAF PrPb filter enabled. Active video edge control enabled. Pedestal enabled. Square pixel mode enabled.
0x87	0x80	RGB input enabled.
0x88	0x10	16-bit RGB input enabled.
0x8A	0x0C	Timing Mode 2 (subordinate). HSYNC/VSynch synchronization.
0x8C	0x55	Subcarrier frequency register values for CVBS and/or S-Video (Y-C) output in NTSC square pixel mode (24.5454 MHz input clock).
0x8D	0x55	
0x8E	0x55	
0x8F	0x25	

Table 81. 8-Bit 625i YCrCb In (EAV/SAV), YPrPb Out

Subaddress	Setting	Description
0x17	0x02	Software reset.
0x00	0x1C	All DACs enabled. PLL enabled (16×).
0x01	0x00	SD input mode.
0x80	0x11	PAL standard. SSAF luma filter enabled. 1.3 MHz chroma filter enabled.
0x82	0xC1	Pixel data valid. YPrPb out. SSAF PrPb filter enabled. Active video edge control enabled.

Table 82. 8-Bit 625i YCrCb In (EAV/SAV), CVBS/Y-C Out

Subaddress	Setting	Description
0x17	0x02	Software reset.
0x00	0x1C	All DACs enabled. PLL enabled (16×).
	0x10	WLCSP required.

Table 82. 8-Bit 625i YCrCb In (EAV/SAV), CVBS/Y-C Out (Continued)

Subaddress	Setting	Description
0x01	0x00	SD input mode.
0x80	0x11	PAL standard. SSAF luma filter enabled. 1.3 MHz chroma filter enabled.
0x82	0xC3	Pixel data valid. CVBS/Y-C (S-Video) out. SSAF PrPb filter enabled. Active video edge control enabled.
0x8C	0xCB	Subcarrier frequency register values for CVBS and/or S-Video (Y-C) output in PAL mode (27 MHz input clock).
0x8D	0x8A	
0x8E	0x09	
0x8F	0x2A	

Table 83. 8-Bit 625i YCrCb In, YPrPb Out

Subaddress	Setting	Description
0x17	0x02	Software reset.
0x00	0x1C	All DACs enabled. PLL enabled (16×).
0x01	0x00	SD input mode.
0x80	0x11	PAL standard. SSAF luma filter enabled. 1.3 MHz chroma filter enabled.
0x82	0xC1	Pixel data valid. YPrPb out. SSAF PrPb filter enabled. Active video edge control enabled.
0x8A	0x0C	Timing Mode 2 (subordinate). HSYNC/VSynch synchronization.

Table 84. 8-Bit 625i YCrCb In (EAV/SAV), RGB Out

Subaddress	Setting	Description
0x17	0x02	Software reset.
0x00	0x1C	All DACs enabled. PLL enabled (16×).
0x01	0x00	SD input mode.
0x02	0x10	RGB output enabled. RGB output sync enabled.
0x80	0x11	PAL standard. SSAF luma filter enabled. 1.3 MHz chroma filter enabled.
0x82	0xC1	Pixel data valid. RGB out. SSAF PrPb filter enabled. Active video edge control enabled.

Table 85. 8-Bit 625i YCrCb In, RGB Out

Subaddress	Setting	Description
0x17	0x02	Software reset.
0x00	0x1C	All DACs enabled. PLL enabled (16×).
0x01	0x00	SD input mode.
0x02	0x10	RGB output enabled. RGB output sync enabled.
0x80	0x11	PAL standard. SSAF luma filter enabled. 1.3 MHz chroma filter enabled.
0x82	0xC1	Pixel data valid. RGB out. SSAF PrPb filter enabled. Active video edge control enabled.
0x8A	0x0C	Timing Mode 2 (subordinate). HSYNC/VSynch synchronization.

Table 86. 10-Bit 625i YCrCb In (EAV/SAV), YPrPb Out

Subaddress	Setting	Description
0x17	0x02	Software reset.
0x00	0x1C	All DACs enabled. PLL enabled (16×).

CONFIGURATION SCRIPTS

Table 86. 10-Bit 625i YCrCb In (EAV/SAV), YPrPb Out (Continued)

Subaddress	Setting	Description
0x01	0x00	SD input mode.
0x80	0x11	PAL standard. SSAF luma filter enabled. 1.3 MHz chroma filter enabled.
0x82	0xC1	Pixel data valid. YPrPb out. SSAF PrPb filter enabled. Active video edge control enabled.
0x88	0x10	10-bit input enabled.

Table 87. 10-Bit 625i YCrCb In, YPrPb Out

Subaddress	Setting	Description
0x17	0x02	Software reset.
0x00	0x1C	All DACs enabled. PLL enabled (16×).
0x01	0x00	SD input mode.
0x80	0x11	PAL standard. SSAF luma filter enabled. 1.3 MHz chroma filter enabled.
0x82	0xC1	Pixel data valid. YPrPb out. SSAF PrPb filter enabled. Active video edge control enabled.
0x88	0x10	10-bit input enabled.
0x8A	0x0C	Timing Mode 2 (subordinate). HSYNC/VSNC synchronization.

Table 88. 10-Bit 625i YCrCb In, CVBS/Y-C Out

Subaddress	Setting	Description
0x17	0x02	Software reset.
0x00	0x1C	All DACs enabled. PLL enabled (16×).
0x01	0x00	SD input mode.
0x80	0x11	PAL standard. SSAF luma filter enabled. 1.3 MHz chroma filter enabled.
0x82	0xC3	Pixel Data Valid. CVBS/Y-C (S-Video) Out. SSAF PrPb filter enabled. Active video edge control enabled.
0x88	0x10	10-bit input enabled.
0x8A	0x0C	Timing Mode 2 (subordinate). HSYNC/VSNC synchronization.
0x8C	0xCB	Subcarrier frequency register values for CVBS and/or S-Video (Y-C) output in PAL mode (27 MHz input clock).
0x8D	0x8A	
0x8E	0x09	
0x8F	0x2A	

Table 89. 10-Bit 625i YCrCb In (EAV/SAV), RGB Out

Subaddress	Setting	Description
0x17	0x02	Software reset.
0x00	0x1C	All DACs enabled. PLL enabled (16×).
0x01	0x00	SD input mode.
0x02	0x10	RGB output enabled. RGB output sync enabled.
0x80	0x11	PAL standard. SSAF luma filter enabled. 1.3 MHz chroma filter enabled.
0x82	0xC1	Pixel data valid. RGB out. SSAF PrPb filter enabled. Active video edge control enabled.
0x88	0x10	10-bit input enabled.

Table 90. 10-Bit 625i YCrCb In, RGB Out

Subaddress	Setting	Description
0x17	0x02	Software reset.
0x00	0x1C	All DACs enabled. PLL enabled (16×).
0x01	0x00	SD input mode.
0x02	0x10	RGB output enabled. RGB output sync enabled.
0x80	0x11	PAL standard. SSAF luma filter enabled. 1.3 MHz chroma filter enabled.
0x82	0xC1	Pixel data valid. RGB out. SSAF PrPb filter enabled. Active video edge control enabled.
0x88	0x10	10-bit input enabled.
0x8A	0x0C	Timing Mode 2 (subordinate). HSYNC/VSNC synchronization.

Table 91. 16-Bit 625i YCrCb In, YPrPb Out

Subaddress	Setting	Description
0x17	0x02	Software reset.
0x00	0x1C	All DACs enabled. PLL enabled (16×).
0x01	0x00	SD input mode.
0x80	0x11	PAL standard. SSAF luma filter enabled. 1.3 MHz chroma filter enabled.
0x82	0xC1	Pixel data valid. YPrPb out. SSAF PrPb filter enabled. Active video edge control enabled.
0x88	0x10	16-bit RGB input enabled.
0x8A	0x0C	Timing Mode 2 (subordinate). HSYNC/VSNC synchronization.

Table 92. 16-Bit 625i YCrCb In, RGB Out

Subaddress	Setting	Description
0x17	0x02	Software reset.
0x00	0x1C	All DACs enabled. PLL enabled (16×).
0x01	0x00	SD input mode.
0x02	0x10	RGB output enabled. RGB output sync enabled.
0x80	0x11	PAL standard. SSAF luma filter enabled. 1.3 MHz chroma filter enabled.
0x82	0xC1	Pixel data valid. RGB out. SSAF PrPb filter enabled. Active video edge control enabled.
0x88	0x10	16-bit RGB input enabled.
0x8A	0x0C	Timing Mode 2 (subordinate). HSYNC/VSNC synchronization.

Table 93. 16-Bit 625i RGB In, YPrPb Out

Subaddress	Setting	Description
0x17	0x02	Software reset.
0x00	0x1C	All DACs enabled. PLL enabled (16×).
0x01	0x00	SD input mode.
0x80	0x11	PAL standard. SSAF luma filter enabled. 1.3 MHz chroma filter enabled.
0x82	0xC1	Pixel data valid. YPrPb out. SSAF PrPb filter enabled. Active video edge control enabled.
0x87	0x80	RGB input enabled.
0x88	0x10	16-bit RGB input enabled.

CONFIGURATION SCRIPTS

Table 93. 16-Bit 625i RGB In, YPrPb Out (Continued)

Subaddress	Setting	Description
0x8A	0x0C	Timing Mode 2 (subordinate). HSYNC/VSYNC synchronization.

Table 94. 16-Bit 625i RGB In, CVBS/Y-C Out

Subaddress	Setting	Description
0x17	0x02	Software reset.
0x00	0x1C	All DACs enabled. PLL enabled (16×).
0x01	0x00	SD input mode.
0x80	0x11	PAL standard. SSAF luma filter enabled. 1.3 MHz chroma filter enabled.
0x82	0xC3	Pixel data valid. CVBS/Y-C (S-Video) out. SSAF PrPb filter enabled. Active video edge control enabled.
0x87	0x80	RGB input enabled.
0x88	0x10	16-bit RGB input enabled.
0x8A	0x0C	Timing Mode 2 (subordinate). HSYNC/VSYNC synchronization.
0x8C	0xCB	Subcarrier frequency register values for CVBS and/or S-Video (Y-C) output in PAL mode (27 MHz input clock).
0x8D	0x8A	
0x8E	0x09	
0x8F	0x2A	

Table 95. 16-Bit 625i RGB In, RGB Out

Subaddress	Setting	Description
0x17	0x02	Software reset.
0x00	0x1C	All DACs enabled. PLL enabled (16×).
0x01	0x00	SD input mode.
0x02	0x10	RGB output enabled. RGB output sync enabled.
0x80	0x11	PAL standard. SSAF luma filter enabled. 1.3 MHz chroma filter enabled.
0x82	0xC1	Pixel data valid. RGB out. SSAF PrPb filter enabled. Active video edge control enabled.
0x87	0x80	RGB input enabled.
0x88	0x10	16-bit RGB input enabled.
0x8A	0x0C	Timing Mode 2 (subordinate). HSYNC/VSYNC synchronization.

Table 96. 8-Bit PAL Square Pixel YCrCb In (EAV/SAV), CVBS/Y-C Out (Continued)

Subaddress	Setting	Description
0x17	0x02	Software reset.
0x00	0x1C	All DACs enabled. PLL enabled (16×).
	0x10	WLCSP required.
0x01	0x00	SD input mode.
0x80	0x11	PAL standard. SSAF luma filter enabled. 1.3 MHz chroma filter enabled.
0x82	0xD3	Pixel data valid. CVBS/Y-C (S-Video) out. SSAF PrPb filter enabled. Active video edge control enabled. Square pixel mode enabled.
0x8C	0x0C	Subcarrier frequency register values for CVBS and/or S-Video (Y-C) output in PAL square pixel mode (29.5 MHz input clock).
0x8D	0x8C	

Table 96. 8-Bit PAL Square Pixel YCrCb In (EAV/SAV), CVBS/Y-C Out (Continued)

Subaddress	Setting	Description
0x8E	0x79	
0x8F	0x26	

Table 97. 16-Bit PAL Square Pixel RGB In, CVBS/Y-C Out

Subaddress	Setting	Description
0x17	0x02	Software reset.
0x00	0x1C	All DACs enabled. PLL enabled (16×).
0x01	0x00	SD input mode.
0x80	0x11	PAL standard. SSAF luma filter enabled. 1.3 MHz chroma filter enabled.
0x82	0xD3	Pixel data valid. CVBS/Y-C (S-Video) out. SSAF PrPb filter enabled. Active video edge control enabled. Square pixel mode enabled.
0x87	0x80	RGB input enabled.
0x88	0x10	16-bit RGB input enabled.
0x8A	0x0C	Timing Mode 2 (subordinate). HSYNC/VSYNC synchronization.
0x8C	0x0C	Subcarrier frequency register values for CVBS and/or S-Video (Y-C) output in PAL square pixel mode (29.5 MHz input clock).
0x8D	0x8C	
0x8E	0x79	
0x8F	0x26	

CONFIGURATION SCRIPTS

ENHANCED DEFINITION

Table 98. ED Configuration Scripts

Input Format	Input Data Width	Synchronization Format	Input Color Space	Output Color Space	Table Number
525p	8-bit DDR	EAV/SAV	YCrCb	YPrPb	Table 107
525p	8-bit DDR	EAV/SAV	YCrCb	RGB	Table 109
525p	10-bit DDR	EAV/SAV	YCrCb	YPrPb	Table 108
525p	10-bit DDR	EAV/SAV	YCrCb	RGB	Table 110
525p	16-bit SDR	EAV/SAV	YCrCb	YPrPb	Table 99
525p	16-bit SDR	HSYNC/VSYNC	YCrCb	YPrPb	Table 100
525p	16-bit SDR	EAV/SAV	YCrCb	RGB	Table 101
525p	16-bit SDR	HSYNC/VSYNC	YCrCb	RGB	Table 102
625p	8-bit DDR	EAV/SAV	YCrCb	YPrPb	Table 111
625p	8-bit DDR	EAV/SAV	YCrCb	RGB	Table 113
625p	10-bit DDR	EAV/SAV	YCrCb	YPrPb	Table 112
625p	10-bit DDR	EAV/SAV	YCrCb	RGB	Table 114
625p	16-bit SDR	EAV/SAV	YCrCb	YPrPb	Table 103
625p	16-bit SDR	HSYNC/VSYNC	YCrCb	YPrPb	Table 104
625p	16-bit SDR	EAV/SAV	YCrCb	RGB	Table 105
625p	16-bit SDR	HSYNC/VSYNC	YCrCb	RGB	Table 106

Table 99. 16-Bit 525p YCrCb In (EAV/SAV), YPrPb Out

Subaddress	Setting	Description
0x17	0x02	Software reset.
0x00	0x1C	All DACs enabled. PLL enabled (8×).
0x01	0x10	ED-SDR input mode.
0x30	0x04	525p at 59.94 Hz. EAV/SAV synchronization. EIA-770.2 output levels.
0x31	0x01	Pixel data valid.

Table 100. 16-Bit 525p YCrCb In, YPrPb Out

Subaddress	Setting	Description
0x17	0x02	Software reset.
0x00	0x1C	All DACs enabled. PLL enabled (8×).
0x01	0x10	ED-SDR input mode.
0x30	0x00	525p at 59.94 Hz. HSYNC/VSYNC synchronization. EIA-770.2 output levels.
0x31	0x01	Pixel data valid.

Table 101. 16-Bit 525p YCrCb In (EAV/SAV), RGB Out

Subaddress	Setting	Description
0x17	0x02	Software reset.
0x00	0x1C	All DACs enabled. PLL enabled (8×).
0x01	0x10	ED-SDR input mode.
0x02	0x10	RGB output enabled. RGB output sync enabled.
0x30	0x04	525p at 59.94 Hz. EAV/SAV synchronization. EIA-770.2 output levels.
0x31	0x01	Pixel data valid.

Table 102. 16-Bit 525p YCrCb In, RGB Out

Subaddress	Setting	Description
0x17	0x02	Software reset.
0x00	0x1C	All DACs enabled. PLL enabled (8×).

Table 102. 16-Bit 525p YCrCb In, RGB Out (Continued)

Subaddress	Setting	Description
0x01	0x10	ED-SDR input mode.
0x02	0x10	RGB output enabled. RGB output sync enabled.
0x30	0x00	525p at 59.94 Hz. HSYNC/VSYNC synchronization. EIA-770.2 output levels.
0x31	0x01	Pixel data valid.

Table 103. 16-Bit 625p YCrCb In (EAV/SAV), YPrPb Out

Subaddress	Setting	Description
0x17	0x02	Software reset.
0x00	0x1C	All DACs enabled. PLL enabled (8×).
0x01	0x10	ED-SDR input mode.
0x30	0x1C	625p at 50 Hz. EAV/SAV synchronization. EIA-770.2 output levels.
0x31	0x01	Pixel data valid.

Table 104. 16-Bit 625p YCrCb In, YPrPb Out

Subaddress	Setting	Description
0x17	0x02	Software reset.
0x00	0x1C	All DACs enabled. PLL enabled (8×).
0x01	0x10	ED-SDR input mode.
0x30	0x18	625p at 50 Hz. HSYNC/VSYNC synchronization. EIA-770.2 output levels.
0x31	0x01	Pixel data valid.

Table 105. 16-Bit 625p YCrCb In (EAV/SAV), RGB Out

Subaddress	Setting	Description
0x17	0x02	Software reset.
0x00	0x1C	All DACs enabled. PLL enabled (8×).
0x01	0x10	ED-SDR input mode.
0x02	0x10	RGB output enabled. RGB output sync enabled.

CONFIGURATION SCRIPTS

Table 105. 16-Bit 625p YCrCb In (EAV/SAV), RGB Out (Continued)

Subaddress	Setting	Description
0x30	0x1C	625p at 50 Hz. EAV/SAV synchronization. EIA-770.2 output levels.
0x31	0x01	Pixel data valid.

Table 106. 16-Bit 625p YCrCb In, RGB Out

Subaddress	Setting	Description
0x17	0x02	Software reset.
0x00	0x1C	All DACs enabled. PLL enabled (8×).
0x01	0x10	ED-SDR input mode.
0x02	0x10	RGB output enabled. RGB output sync enabled.
0x30	0x18	625p at 50 Hz. HSYNC/VSYNc synchronization. EIA-770.2 output levels.
0x31	0x01	Pixel data valid.

Table 107. 8-Bit 525p YCrCb In (EAV/SAV), YPrPb Out

Subaddress	Setting	Description
0x17	0x02	Software reset.
0x00	0x1C	All DACs enabled. PLL enabled (8×).
0x01	0x20	ED-DDR input mode. Luma data clocked on falling edge of CLKIN.
0x30	0x04	525p at 59.94 Hz. EAV/SAV synchronization. EIA-770.2 output levels.
0x31	0x01	Pixel data valid.

Table 108. 10-Bit 525p YCrCb In (EAV/SAV), YPrPb Out

Subaddress	Setting	Description
0x17	0x02	Software reset.
0x00	0x1C	All DACs enabled. PLL enabled (8×).
0x01	0x20	ED-DDR input mode. Luma data clocked on falling edge of CLKIN.
0x30	0x04	525p at 59.94 Hz. EAV/SAV synchronization. EIA-770.2 output levels.
0x31	0x01	Pixel data valid.
0x33	0x6C	10-bit input enabled.

Table 109. 8-Bit 525p YCrCb In (EAV/SAV), RGB Out

Subaddress	Setting	Description
0x17	0x02	Software reset.
0x00	0x1C	All DACs enabled. PLL enabled (8×).
0x01	0x20	ED-DDR input mode. Luma data clocked on falling edge of CLKIN.
0x02	0x10	RGB output enabled. RGB output sync enabled.
0x30	0x04	525p at 59.94 Hz. EAV/SAV synchronization. EIA-770.2 output levels.
0x31	0x01	Pixel data valid.

Table 110. 10-Bit 525p YCrCb In (EAV/SAV), RGB Out

Subaddress	Setting	Description
0x17	0x02	Software reset.
0x00	0x1C	All DACs enabled. PLL enabled (8×).

Table 110. 10-Bit 525p YCrCb In (EAV/SAV), RGB Out (Continued)

Subaddress	Setting	Description
0x01	0x20	ED-DDR input mode. Luma data clocked on falling edge of CLKIN.
0x02	0x10	RGB output enabled. RGB output sync enabled.
0x30	0x04	525p at 59.94 Hz. EAV/SAV synchronization. EIA-770.2 output levels.
0x31	0x01	Pixel data valid.
0x33	0x6C	10-bit input enabled.

Table 111. 8-Bit 625p YCrCb In (EAV/SAV), YPrPb Out

Subaddress	Setting	Description
0x17	0x02	Software reset.
0x00	0x1C	All DACs enabled. PLL enabled (8×).
0x01	0x20	ED-DDR input mode. Luma data clocked on falling edge of CLKIN.
0x30	0x1C	625p at 50 Hz. EAV/SAV synchronization. EIA-770.2 output levels.
0x31	0x01	Pixel data valid.

Table 112. 10-Bit 625p YCrCb In (EAV/SAV), YPrPb Out

Subaddress	Setting	Description
0x17	0x02	Software reset.
0x00	0x1C	All DACs enabled. PLL enabled (8×).
0x01	0x20	ED-DDR input mode. Luma data clocked on falling edge of CLKIN.
0x30	0x1C	625p at 50 Hz. EAV/SAV synchronization. EIA-770.2 output levels.
0x31	0x01	Pixel data valid.
0x33	0x6C	10-bit input enabled.

Table 113. 8-Bit 625p YCrCb In (EAV/SAV), RGB Out

Subaddress	Setting	Description
0x17	0x02	Software reset.
0x00	0x1C	All DACs enabled. PLL enabled (8×).
0x01	0x20	ED-DDR input mode. Luma data clocked on falling edge of CLKIN.
0x02	0x10	RGB output enabled. RGB output sync enabled.
0x30	0x1C	625p at 50 Hz. EAV/SAV synchronization. EIA-770.2 output levels.
0x31	0x01	Pixel data valid.

Table 114. 10-Bit 625p YCrCb In (EAV/SAV), RGB Out

Subaddress	Setting	Description
0x17	0x02	Software reset.
0x00	0x1C	All DACs enabled. PLL enabled (8×).
0x01	0x20	ED-DDR input mode. Luma data clocked on falling edge of CLKIN.
0x02	0x10	RGB output enabled. RGB output sync enabled.
0x30	0x1C	625p at 50 Hz. EAV/SAV synchronization. EIA-770.2 output levels.
0x31	0x01	Pixel data valid.
0x33	0x6C	10-bit input enabled.

CONFIGURATION SCRIPTS

HIGH DEFINITION

Table 115. HD Configuration Scripts

Input Format	Input Data Width	Synchronization Format	Input Color Space	Output Color Space	Table Number
720p	8-bit DDR	EAV/SAV	YCrCb	YPrPb	Table 124
720p	8-bit DDR	EAV/SAV	YCrCb	RGB	Table 126
720p	10-bit DDR	EAV/SAV	YCrCb	YPrPb	Table 125
720p	10-bit DDR	EAV/SAV	YCrCb	RGB	Table 127
720p	16-bit SDR	EAV/SAV	YCrCb	YPrPb	Table 116
720p	16-bit SDR	HSYNC/VSYNC	YCrCb	YPrPb	Table 117
720p	16-bit SDR	EAV/SAV	YCrCb	RGB	Table 118
720p	16-bit SDR	HSYNC/VSYNC/	YCrCb	RGB	Table 119
1080i	8-bit DDR	EAV/SAV	YCrCb	YPrPb	Table 128
1080i	8-bit DDR	EAV/SAV	YCrCb	RGB	Table 130
1080i	10-bit DDR	EAV/SAV	YCrCb	YPrPb	Table 129
1080i	10-bit DDR	EAV/SAV	YCrCb	RGB	Table 131
1080i	16-bit SDR	EAV/SAV	YCrCb	YPrPb	Table 120
1080i	16-bit SDR	HSYNC/VSYNC	YCrCb	YPrPb	Table 121
1080i	16-bit SDR	EAV/SAV	YCrCb	RGB	Table 122
1080i	16-bit SDR	HSYNC/VSYNC	YCrCb	RGB	Table 123

Table 116. 16-Bit 720p YCrCb In (EAV/SAV), YPrPb Out

Subaddress	Setting	Description
0x17	0x02	Software reset.
0x00	0x1C	All DACs enabled. PLL enabled (4x).
0x01	0x10	HD-SDR input mode.
0x30	0x2C	720p at 60 Hz/59.94 Hz. EAV/SAV synchronization. EIA-770.3 output levels.
0x31	0x01	Pixel data valid. 4x oversampling.

Table 117. 16-Bit 720p YCrCb In, YPrPb Out

Subaddress	Setting	Description
0x17	0x02	Software reset.
0x00	0x1C	All DACs enabled. PLL enabled (4x).
0x01	0x10	HD-SDR input mode.
0x30	0x28	720p at 60 Hz/59.94 Hz. HSYNC/VSYNC synchronization. EIA-770.3 output levels.
0x31	0x01	Pixel data valid. 4x oversampling.

Table 118. 16-Bit 720p YCrCb In (EAV/SAV), RGB Out

Subaddress	Setting	Description
0x17	0x02	Software reset.
0x00	0x1C	All DACs enabled. PLL enabled (4x).
0x01	0x10	HD-SDR input mode.
0x02	0x10	RGB output enabled. RGB output sync enabled.
0x30	0x2C	720p at 60 Hz/59.94 Hz. EAV/SAV synchronization. EIA-770.3 output levels.
0x31	0x01	Pixel data valid. 4x oversampling.

Table 119. 16-Bit 720p YCrCb In, RGB Out

Subaddress	Setting	Description
0x17	0x02	Software reset.
0x00	0x1C	All DACs enabled. PLL enabled (4x).

Table 119. 16-Bit 720p YCrCb In, RGB Out (Continued)

Subaddress	Setting	Description
0x01	0x10	HD-SDR input mode.
0x02	0x10	RGB output enabled. RGB output sync enabled.
0x30	0x28	720p at 60 Hz/59.94 Hz. HSYNC/VSYNC synchronization. EIA-770.3 output levels.
0x31	0x01	Pixel data valid. 4x oversampling.

Table 120. 16-Bit 1080i YCrCb In (EAV/SAV), YPrPb Out

Subaddress	Setting	Description
0x17	0x02	Software reset.
0x00	0x1C	All DACs enabled. PLL enabled (4x).
0x01	0x10	HD-SDR input mode.
0x30	0x6C	1080i at 30 Hz/29.97 Hz. EAV/SAV synchronization. EIA-770.3 output levels.
0x31	0x01	Pixel data valid. 4x oversampling.

Table 121. 16-Bit 1080i YCrCb In, YPrPb Out

Subaddress	Setting	Description
0x17	0x02	Software reset.
0x00	0x1C	All DACs enabled. PLL enabled (4x).
0x01	0x10	HD-SDR input mode.
0x30	0x18	1080i at 30 Hz/29.97 Hz. HSYNC/VSYNC synchronization. EIA-770.3 output levels.
0x31	0x01	Pixel data valid. 4x oversampling.

Table 122. 16-Bit 1080i YCrCb In (EAV/SAV), RGB Out

Subaddress	Setting	Description
0x17	0x02	Software reset.
0x00	0x1C	All DACs enabled. PLL enabled (4x).
0x01	0x10	HD-SDR input mode.
0x02	0x10	RGB output enabled. RGB output sync enabled.

CONFIGURATION SCRIPTS

Table 122. 16-Bit 1080i YCrCb In (EAV/SAV), RGB Out (Continued)

Subaddress	Setting	Description
0x30	0x6C	1080i at 30 Hz/29.97 Hz. EAV/SAV synchronization. EIA-770.3 output levels.
0x31	0x01	Pixel data valid. 4× oversampling.

Table 123. 16-Bit 1080i YCrCb In, RGB Out

Subaddress	Setting	Description
0x17	0x02	Software reset.
0x00	0x1C	All DACs enabled. PLL enabled (4×).
0x01	0x10	HD-SDR input mode.
0x02	0x10	RGB output enabled. RGB output sync enabled.
0x30	0x18	1080i at 30 Hz/29.97 Hz. HSYNC/VSYNC synchronization. EIA-770.3 output levels.
0x31	0x01	Pixel data valid. 4× oversampling.

Table 124. 8-Bit 720p YCrCb In (EAV/SAV), YPrPb Out

Subaddress	Setting	Description
0x17	0x02	Software reset.
0x00	0x1C	All DACs enabled. PLL enabled (4×).
0x01	0x20	HD-DDR input mode. Luma data clocked on falling edge of CLKIN.
0x30	0x2C	720p at 60 Hz/59.94 Hz. EAV/SAV synchronization. EIA-770.3 output levels.
0x31	0x01	Pixel data valid. 4× oversampling.

Table 125. 10-Bit 720p YCrCb In (EAV/SAV), YPrPb Out

Subaddress	Setting	Description
0x17	0x02	Software reset.
0x00	0x1C	All DACs enabled. PLL enabled (4×).
0x01	0x20	HD-DDR input mode. Luma data clocked on falling edge of CLKIN.
0x30	0x2C	720p at 60 Hz/59.94 Hz. EAV/SAV synchronization. EIA-770.3 output levels.
0x31	0x01	Pixel data valid. 4× oversampling.
0x33	0x6C	10-bit input enabled.

Table 126. 8-Bit 720p YCrCb In (EAV/SAV), RGB Out

Subaddress	Setting	Description
0x17	0x02	Software reset.
0x00	0x1C	All DACs enabled. PLL enabled (4×).
0x01	0x20	HD-DDR input mode. Luma data clocked on falling edge of CLKIN.
0x02	0x10	RGB output enabled. RGB output sync enabled.
0x30	0x2C	720p at 60 Hz/59.94 Hz. EAV/SAV synchronization. EIA-770.3 output levels.
0x31	0x01	Pixel data valid. 4× oversampling.

Table 127. 10-Bit 720p YCrCb In (EAV/SAV), RGB Out

Subaddress	Setting	Description
0x17	0x02	Software reset.
0x00	0x1C	All DACs enabled. PLL enabled (4×).

Table 127. 10-Bit 720p YCrCb In (EAV/SAV), RGB Out (Continued)

Subaddress	Setting	Description
0x01	0x20	HD-DDR input mode. Luma data clocked on falling edge of CLKIN.
0x02	0x10	RGB output enabled. RGB output sync enabled.
0x30	0x2C	720p at 60 Hz/59.94 Hz. EAV/SAV synchronization. EIA-770.3 output levels.
0x31	0x01	Pixel data valid. 4× oversampling.
0x33	0x6C	10-bit input enabled.

Table 128. 8-Bit 1080i YCrCb In (EAV/SAV), YPrPb Out

Subaddress	Setting	Description
0x17	0x02	Software reset.
0x00	0x1C	All DACs enabled. PLL enabled (4×).
0x01	0x20	HD-DDR input mode. Luma data clocked on falling edge of CLKIN.
0x30	0x6C	1080i at 30 Hz/29.97 Hz. EAV/SAV synchronization. EIA-770.3 output levels.
0x31	0x01	Pixel data valid. 4× oversampling.

Table 129. 10-Bit 1080i YCrCb In (EAV/SAV), YPrPb Out

Subaddress	Setting	Description
0x17	0x02	Software reset.
0x00	0x1C	All DACs enabled. PLL enabled (4×).
0x01	0x20	HD-DDR input mode. Luma data clocked on falling edge of CLKIN.
0x30	0x6C	1080i at 30 Hz/29.97 Hz. EAV/SAV synchronization. EIA-770.3 output levels.
0x31	0x01	Pixel data valid. 4× oversampling.
0x33	0x6C	10-bit input enabled.

Table 130. 8-Bit 1080i YCrCb In (EAV/SAV), RGB Out

Subaddress	Setting	Description
0x17	0x02	Software reset.
0x00	0x1C	All DACs enabled. PLL enabled (4×).
0x01	0x20	HD-DDR input mode. Luma data clocked on falling edge of CLKIN.
0x02	0x10	RGB output enabled. RGB output sync enabled.
0x30	0x6C	1080i at 30 Hz/29.97 Hz. EAV/SAV synchronization. EIA-770.3 output levels.
0x31	0x01	Pixel data valid. 4× oversampling.

Table 131. 10-Bit 1080i YCrCb In (EAV/SAV), RGB Out

Subaddress	Setting	Description
0x17	0x02	Software reset.
0x00	0x1C	All DACs enabled. PLL enabled (4×).
0x01	0x20	HD-DDR input mode. Luma data clocked on falling edge of CLKIN.
0x02	0x10	RGB output enabled. RGB output sync enabled.
0x30	0x6C	1080i @ 30 Hz/29.97 Hz. EAV/SAV synchronization. EIA-770.3 output levels.
0x31	0x01	Pixel data valid. 4× oversampling.
0x33	0x6C	10-bit input enabled.

ADV7390/ADV7391/ADV7392/ADV7393 EVALUATION BOARD

To accommodate evaluation of the ADV7390/ADV7391/ADV7392/ADV7393, Analog Devices provides a two-board solution. The ADV7390/ADV7391/ADV7392/ADV7393 evaluation platform front-end board contains an Analog Devices decoder (ADV7403) and an FPGA. The back-end board (where the actual ADV7390/ADV7391/ADV7392/ADV7393 are attached) is connected to the front-end board through a connector.

These two boards allow the user to perform a complete evaluation of the part, although it is also possible to order only the back-end board. Note that these two boards must be ordered separately.

For more information about the evaluation boards, see the evaluation board documentation available on the Analog Devices product web page.

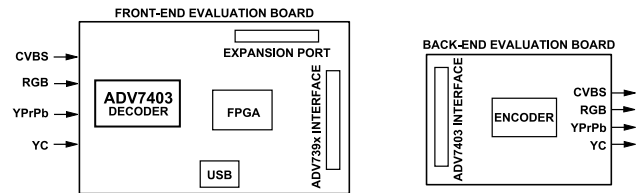

Figure 146. ADV7390/ADV7391/ADV7392/ADV7393 Front-End and Back-End Evaluation Boards

OUTLINE DIMENSIONS

Package Drawing (Option)	Package Type	Package Description
CP-32-3	LFCSP	32-Lead Lead Frame Chip Scale Package
CP-32-13	LFCSP	32-Lead Lead Frame Chip Scale Package
CB-30-3	WLCSP	30-Ball Wafer Level Chip Scale Package
CP-40-9	LFCSP	40-Lead Lead Frame Chip Scale Package
CP-40-1	LFCSP	40-Lead Lead Frame Chip Scale Package

For the latest package outline information and land patterns (footprints), go to [Package Index](#).

ORDERING GUIDE

Model ^{1, 2}	Temperature Range	Package Description	Packing Quantity	Package Option
ADV7390BCPZ	-40°C to +85°C	32-Lead Lead Frame Chip Scale Package [LFCSP]	Tray, 490	CP-32-3
ADV7390BCPZ-REEL	-40°C to +85°C	32-Lead Lead Frame Chip Scale Package [LFCSP]	Reel, 5000	CP-32-3
ADV7390WBCPZ	-40°C to +105°C	32-Lead Lead Frame Chip Scale Package [LFCSP]	Tray, 490	CP-32-13
ADV7390WBCPZ-RL	-40°C to +105°C	32-Lead Lead Frame Chip Scale Package [LFCSP]	Reel, 5000	CP-32-13
ADV7390BCBZ-A-RL	-40°C to +85°C	30-Ball Wafer Level Chip Scale Package [WLCSP]	Reel, 5000	CB-30-3
ADV7391BCPZ	-40°C to +85°C	32-Lead Lead Frame Chip Scale Package [LFCSP]	Tray, 490	CP-32-3
ADV7391BCPZ-REEL	-40°C to +85°C	32-Lead Lead Frame Chip Scale Package [LFCSP]	Reel, 5000	CP-32-3
ADV7391WBCPZ	-40°C to +105°C	32-Lead Lead Frame Chip Scale Package [LFCSP]	Tray, 490	CP-32-13
ADV7391WBCPZ-RL	-40°C to +105°C	32-Lead Lead Frame Chip Scale Package [LFCSP]	Reel, 5000	CP-32-13
ADV7392BCPZ	-40°C to +85°C	40-Lead Lead Frame Chip Scale Package [LFCSP]	Tray, 490	CP-40-1
ADV7392BCPZ-REEL	-40°C to +85°C	40-Lead Lead Frame Chip Scale Package [LFCSP]	Reel, 2500	CP-40-1
ADV7392BCPZ-3REEL	-40°C to +85°C	40-Lead Lead Frame Chip Scale Package [LFCSP]	Reel, 2500	CP-40-1
ADV7392WBCPZ	-40°C to +105°C	40-Lead Lead Frame Chip Scale Package [LFCSP]	Tray, 490	CP-40-9
ADV7392WBCPZ-REEL	-40°C to +105°C	40-Lead Lead Frame Chip Scale Package [LFCSP]	Reel, 2500	CP-40-9
ADV7393BCPZ	-40°C to +85°C	40-Lead Lead Frame Chip Scale Package [LFCSP]	Tray, 490	CP-40-1
ADV7393BCPZ-REEL	-40°C to +85°C	40-Lead Lead Frame Chip Scale Package [LFCSP]	Reel, 2500	CP-40-1
ADV7393WBCPZ	-40°C to +105°C	40-Lead Lead Frame Chip Scale Package [LFCSP]	Tray, 490	CP-40-9
ADV7393WBCPZ-REEL	-40°C to +105°C	40-Lead Lead Frame Chip Scale Package [LFCSP]	Reel, 2500	CP-40-9

¹ Z = RoHS Compliant Part.

² W = Qualified for Automotive Applications.

MACROVISION ANTITAPING

Model ^{1, 2}	Macrovision ³ Antitaping
ADV7390BCPZ	Yes
ADV7390BCPZ-REEL	Yes
ADV7390WBCPZ	Yes
ADV7390WBCPZ-RL	Yes
ADV7390BCBZ-A-RL	Yes
ADV7391BCPZ	No
ADV7391BCPZ-REEL	No
ADV7391WBCPZ	No
ADV7391WBCPZ-RL	No
ADV7392BCPZ	Yes
ADV7392BCPZ-REEL	Yes
ADV7392BCPZ-3REEL	Yes
ADV7392WBCPZ	Yes

OUTLINE DIMENSIONS

Model ^{1, 2}	Macrovision ³ Antitaping
ADV7392WBCPZ-REEL	Yes
ADV7393BCPZ	No
ADV7393BCPZ-REEL	No
ADV7393WBCPZ	No
ADV7393WBCPZ-REEL	No

¹ Z = RoHS Compliant Part.

² W = Qualified for Automotive Applications.

³ Macrovision-enabled ICs require the buyer to be an approved licensee (authorized buyer) of ICs that are able to output Macrovision Rev 7.1.L1-compliant video.

EVALUATION BOARDS

Model ¹	Description
EVAL-ADV739xFEZ	ADV739x Evaluation Platform Front-End Board
EVAL-ADV7390EBZ	ADV7390 Evaluation Board
EVAL-ADV7391EBZ	ADV7391 Evaluation Board
EVAL-ADV7392EBZ	ADV7392 Evaluation Board
EVAL-ADV7393EBZ	ADV7393 Evaluation Board

¹ Z = RoHS Compliant Part.

AUTOMOTIVE PRODUCTS

The [ADV7390W](#), [ADV7391W](#), [ADV7392W](#), and [ADV7393W](#) models are available with controlled manufacturing to support the quality and reliability requirements of automotive applications. Note that these automotive models may have specifications that differ from the commercial models; therefore, designers should review the [Specifications](#) section of this data sheet carefully. Only the automotive grade products shown are available for use in automotive applications. Contact your local Analog Devices account representative for specific product ordering information and to obtain the specific Automotive Reliability reports for these models.

I²C refers to a communications protocol originally developed by Philips Semiconductors (now NXP Semiconductors).