

1 GHz to 60 GHz, Reflective, Silicon SPDT Switch

**FEATURES**

- ▶ Ultra-wideband frequency range: 1 GHz to 60 GHz
- ▶ Low insertion loss
  - ▶ 1.3 dB typical up to 40 GHz
  - ▶ 1.9 dB typical up to 55 GHz
  - ▶ 2.0 dB typical up to 60 GHz
- ▶ High isolation
  - ▶ 43 dB typical up to 40 GHz
  - ▶ 37 dB typical up to 55 GHz
  - ▶ 32 dB typical up to 60 GHz
- ▶ High input linearity
  - ▶ P0.1dB: 24 dBm typical
  - ▶ IP3: 45 dBm typical
- ▶ High RF power handling
  - ▶ Through path: 24 dBm
  - ▶ Hot switching path: 21 dBm
- ▶ CMOS/LVTTL compatible
- ▶ No low-frequency spur
- ▶ Fast RF switching time: 15 ns
- ▶ RF settling time (50%  $V_{CTRL}$  to 0.1 dB of RF output): 35 ns
- ▶ Single-supply operation capability ( $V_{DD} = 3.3\text{ V}$ ,  $V_{SS} = 0\text{ V}$ )
- ▶ 12-terminal, 2.5 mm × 2.5 mm, RoHS-compliant, LGA package

**APPLICATIONS**

- ▶ Industrial scanners
- ▶ Test and instrumentation
- ▶ Cellular infrastructure: 5G mmWave
- ▶ Military radios, radars, electronic counter measures (ECMs)
- ▶ Microwave radios and very small aperture terminals (VSATs)

**FUNCTIONAL BLOCK DIAGRAM**

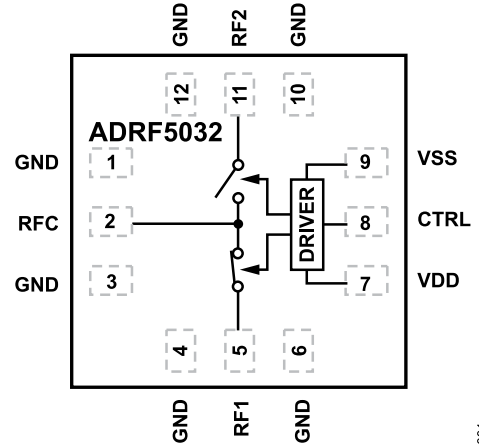

Figure 1. Functional Block Diagram

**GENERAL DESCRIPTION**

The ADRF5032 is a reflective, single-pole double-throw (SPDT) switch manufactured using the silicon process. The ADRF5032 operates from 1 GHz to 60 GHz with insertion loss of lower than 2.0 dB and isolation of higher than 32 dB. The device has an RF input power handling capability of 24 dBm for both through paths and 21 dBm for hot switching. The ADRF5032 requires dual-supply voltages of  $\pm 3.3\text{ V}$ . The ADRF5032 employs CMOS and low-voltage transistor to transistor logic (LVTTTL)-compatible control.

The ADRF5032 can also operate with a single positive supply voltage ( $V_{DD}$ ) applied while the negative supply voltage ( $V_{SS}$ ) is tied to ground. In this operating condition, the small signal performance is maintained while the switching characteristics, linearity, and power handling performance are derated. See Table 2 for more details.

The ADRF5032 is packaged in a 12-terminal, 2.5 mm × 2.5 mm, RoHS-compliant, land grid array (LGA). The ADRF5032 operates from  $-40^{\circ}\text{C}$  to  $+105^{\circ}\text{C}$ .

**TABLE OF CONTENTS**

Features.....	1	Typical Performance Characteristics.....	7
Applications .....	1	Insertion Loss, Return Loss, and Isolation.....	7
Functional Block Diagram.....	1	Input Power Compression and Third-Order	
General Description.....	1	Intercept .....	8
Specifications.....	3	Theory of Operation.....	9
Single-Supply Operation.....	4	RF Input and Output.....	9
Absolute Maximum Ratings.....	5	Power Supply.....	9
Thermal Resistance.....	5	Applications Information.....	10
Power Derating Curves.....	5	Recommendations for Printed Circuit Board	
Electrostatic Discharge (ESD) Ratings.....	5	Design.....	10
ESD Caution.....	5	Outline Dimensions.....	11
Pin Configuration and Function Descriptions.....	6	Ordering Guide.....	11
Interface Schematics.....	6		

**REVISION HISTORY****6/2023—Rev. 0 to Rev. A**

Changes to Features Section.....	1
Changes to General Description Section.....	1
Changes to Table 1.....	3
Added Single-Supply Operation Section and Table 2; Renumbered Sequentially.....	4
Changes to Table 3.....	5
Changes to RF Input and Output Section.....	9
Changes to Power Supply Section.....	9
Changes to Applications Information Section and Figure 16.....	10
Deleted Evaluation Board Section.....	10
Deleted Evaluation Boards.....	11

**2/2023—Revision 0: Initial Version**

## SPECIFICATIONS

$V_{DD} = 3.3\text{ V}$ ,  $V_{SS} = -3.3\text{ V}$ ,  $V_{CTL} = 0\text{ V}$  or  $V_{DD}$ ,  $T_{CASE} = 25^\circ\text{C}$ ,  $50\ \Omega$  system, unless otherwise noted. RFx refers to RF1 or RF2.

Table 1. Electrical Characteristics

Parameter	Symbol	Test Conditions/Comments	Min	Typ	Max	Unit
FREQUENCY RANGE	f		1		60	GHz
INSERTION LOSS						
Between RFC and RFx (On)		1 GHz to 18 GHz		1.1		dB
		18 GHz to 40 GHz		1.3		dB
		40 GHz to 55 GHz		1.9		dB
		55 GHz to 60 GHz		2.0		dB
RETURN LOSS						
RFC		1 GHz to 18 GHz		22		dB
		18 GHz to 40 GHz		17		dB
		40 GHz to 55 GHz		16		dB
		55 GHz to 60 GHz		18		dB
RFx		1 GHz to 18 GHz		24		dB
		18 GHz to 40 GHz		23		dB
		40 GHz to 55 GHz		19		dB
		55 GHz to 60 GHz		18		dB
ISOLATION						
Between RFC and RFx		1 GHz to 18 GHz		46		dB
		18 GHz to 40 GHz		43		dB
		40 GHz to 55 GHz		37		dB
		55 GHz to 60 GHz		32		dB
Between RFx and RFx		1 GHz to 18 GHz		50		dB
		18 GHz to 40 GHz		45		dB
		40 GHz to 55 GHz		40		dB
		55 GHz to 60 GHz		36		dB
SWITCHING						
Rise and Fall Time	$t_{RISE}, t_{FALL}$	10% to 90% of RF output		5		ns
On and Off Time	$t_{ON}, t_{OFF}$	50% $V_{CTL}$ to 90% of RF output		15		ns
Settling Time		50% $V_{CTL}$ to 0.1 dB of final RF output		35		ns
INPUT LINEARITY <sup>1</sup>		f = 1 GHz to 60 GHz				
Input Compression	P0.1dB			24		dBm
Third-Order Intercept	IP3	Two-tone input power = 12 dBm each tone, $\Delta f = 1\text{ MHz}$		45		dBm
SUPPLY CURRENT		VDD and VSS pins				
Positive Supply Current	$I_{DD}$			130		$\mu\text{A}$
Negative Supply Current	$I_{SS}$			490		A
DIGITAL CONTROL INPUTS		CTRL pin				
Voltage						
Low	$V_{INL}$		0		0.8	V
High	$V_{INH}$		1.2		3.3	V
Current						
Low and High	$I_{INL}, I_{INH}$			<1		$\mu\text{A}$
RECOMMENDED OPERATING CONDITIONS						
Supply Voltage						
Positive	$V_{DD}$		3.15		3.45	V
Negative	$V_{SS}$		-3.45		-3.15	V
Digital Control Inputs Voltage	$V_{CTL}$		0		$V_{DD}$	V

## SPECIFICATIONS

Table 1. Electrical Characteristics (Continued)

Parameter	Symbol	Test Conditions/Comments	Min	Typ	Max	Unit
RF Input Power <sup>2,3</sup> Through Path	P <sub>IN</sub>	f = 3 GHz to 60 GHz, T <sub>CASE</sub> = 85°C RF signal is applied to RFC or through connected RF1/RF2			24	dBm
Hot Switching		RF signal is applied to RFC or through connected RF1/RF2			21	dBm
Case Temperature	T <sub>CASE</sub>		-40		+105	°C

<sup>1</sup> For input linearity performance over frequency, see Figure 12 to Figure 15.

<sup>2</sup> For power derating over frequency, see the Power Derating Curves section.

<sup>3</sup> For 105°C operation, the power handling degrades from the T<sub>CASE</sub> = 85°C specification by 3 dB.

## SINGLE-SUPPLY OPERATION

V<sub>DD</sub> = 3.3 V, V<sub>SS</sub> = 0 V, V<sub>CTL</sub> = 0 V or V<sub>DD</sub>, T<sub>CASE</sub> = 25°C for 50 Ω system, unless otherwise noted.

Table 2. Single-Supply Operational Specifications

Parameter	Symbol	Test Conditions/Comments	Min	Typ	Max	Unit
FREQUENCY RANGE	f		1		60	GHz
SWITCHING CHARACTERISTICS						
Rise and Fall Time	t <sub>RISE</sub> , t <sub>FALL</sub>	10% to 90% of RF output		20		ns
On and Off Time	t <sub>ON</sub> , t <sub>OFF</sub>	50% V <sub>CTRL</sub> to 90% of RF output		38		ns
0.1 dB RF Settling Time		50% V <sub>CTRL</sub> to 0.1 dB of final RF output		42		ns
INPUT LINEARITY		f = 1 GHz to 60 GHz				
0.1 dB Power Compression	P0.1dB			14		dBm
Input Third-Order Intercept	IIP3	Two-tone input power = 0 dBm each tone, Δf = 1 MHz		41		dBm
RECOMMENDED OPERATING CONDITIONS						
RF Input Power <sup>1</sup> Through Path	P <sub>IN</sub>	f = 3 GHz to 60 GHz, T <sub>CASE</sub> = 85°C RF signal is applied to the RFC or through connected RF1/RF2			14	dBm
Hot Switching		RF signal is applied to the RFC while switching between RF1/RF2			11	dBm

<sup>1</sup> For 105°C operation, the power handling degrades from the T<sub>CASE</sub> = 85°C specification by 1 dB.

## ABSOLUTE MAXIMUM RATINGS

For the recommended operating conditions, see Table 1.

**Table 3. Absolute Maximum Ratings**

Parameter	Rating
Positive Supply Voltage	-0.3 V to +3.6 V
Negative Supply Voltage	-3.6 V to +0.3 V
Digital Control Input <sup>1</sup>	
Voltage	-0.3 V to $V_{DD} + 0.3$ V
Current	3 mA
RF Input Power, Dual Supply <sup>2</sup> ( $V_{DD} = 3.3$ V, $V_{SS} = -3.3$ V, $f = 3$ GHz to 60 GHz, $T_{CASE} = 85^{\circ}\text{C}^3$ )	
Through Path	25 dBm
Hot Switching (RFC)	22 dBm
RF Input Power, Single Supply ( $V_{DD} = 3.3$ V, $V_{SS} = 0$ V, $f = 3$ GHz to 60 GHz, $T_{CASE} = 85^{\circ}\text{C}^3$ )	
Through Path	15 dBm
Hot Switching (RFC)	12 dBm
RF Input Power, Unbiased ( $V_{DD}, V_{SS} = 0$ V)	15 dBm
Temperature	
Junction, $T_J$	135°C
Storage Range	-65°C to +150°C
Reflow	260°C

- Overvoltages at the digital control input are clamped by internal diodes. Current must be limited to the maximum rating given.
- For power derating over frequency, see Figure 2.
- For 105°C operation, the power handling degrades from the  $T_{CASE} = 85^{\circ}\text{C}$  specification by 3 dB for dual supply and 1 dB for single supply.

Stresses at or above those listed under Absolute Maximum Ratings may cause permanent damage to the product. This is a stress rating only; functional operation of the product at these or any other conditions above those indicated in the operational section of this specification is not implied. Operation beyond the maximum operating conditions for extended periods may affect product reliability.

Only one absolute maximum rating can be applied at any one time.

## THERMAL RESISTANCE

Thermal performance is directly linked to printed circuit board (PCB) design and operating environment. Careful attention to PCB thermal design is required.

$\theta_{JC}$  is the junction-to-case bottom (channel-to-package bottom) thermal resistance.

**Table 4. Thermal Resistance**

Package Type	$\theta_{JC}^1$	Unit
CC-12-07, Through Path	476	°C/W

- $\theta_{JC}$  was determined by simulation under the following conditions: the heat transfer is due solely to the thermal conduction from the channel through the ground pad to the PCB, and the ground pad is held constant at the operating temperature of 85°C.

## POWER DERATING CURVES

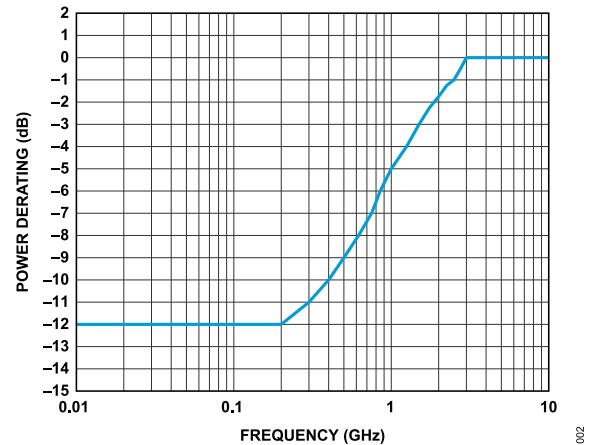

Figure 2. Power Derating vs. Frequency, Low-Frequency Detail,  $T_{CASE} = 85^{\circ}\text{C}$ .

## ELECTROSTATIC DISCHARGE (ESD) RATINGS

The following ESD information is provided for handling of ESD-sensitive devices in an ESD-protected area only.

Human body model (HBM) per ANSI/ESDA/JEDEC JS-001. Charged device model (CDM) ratings are per ANSI/ESDA/JEDEC JS-002.

## ESD Ratings for the ADRF5032

**Table 5. ADRF5032, 20-Terminal LGA**

ESD Model	Withstand Threshold (V)
HBM	±750 for RF Pins ±2000 for Supply and Digital Control Pins
CDM	±500 for All Pins

## ESD CAUTION



**ESD (electrostatic discharge) sensitive device.** Charged devices and circuit boards can discharge without detection. Although this product features patented or proprietary protection circuitry, damage may occur on devices subjected to high energy ESD. Therefore, proper ESD precautions should be taken to avoid performance degradation or loss of functionality.

**PIN CONFIGURATION AND FUNCTION DESCRIPTIONS**

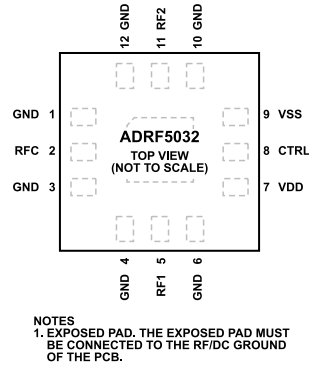

Figure 3. Pin Configuration (Top View)

Table 6. Pin Function Descriptions

Pin No.	Mnemonic	Description
1, 3, 4, 6, 10, 12	GND	Ground. These pins must be connected to the RF/DC ground of the PCB.
2	RFC	RF Common Port. This pin is DC-coupled to 0 V. No DC-blocking capacitor is necessary when the RF line potential is equal to 0 V DC. See Figure 4 for the interface schematic.
5	RF1	RF Port 1. This pin is DC-coupled to 0 V. No DC-blocking capacitor is necessary when the RF line potential is equal to 0 V DC. See Figure 4 for the interface schematic.
7	VDD	Positive Supply Voltage. See Figure 5 for the interface schematic.
8	CTRL	Control Input Voltage. See Figure 6 for the interface schematic.
9	VSS	Negative Supply Voltage. See Figure 7 for the interface schematic.
11	RF2	RF Port 2. This pin is DC-coupled to 0 V. No DC-blocking capacitor is necessary when the RF line potential is equal to 0 V DC. See Figure 4 for the interface schematic.
	EPAD	Exposed Pad. The exposed pad must be connected to the RF/DC ground of the PCB.

**INTERFACE SCHEMATICS**

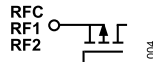

Figure 4. RFx Pins Interface Schematic

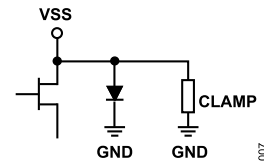

Figure 7. VSS Interface Schematic

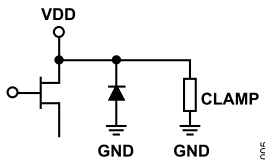

Figure 5. VDD Interface Schematic

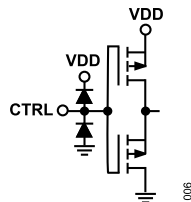

Figure 6. CTRL Pin Interface Schematic

TYPICAL PERFORMANCE CHARACTERISTICS

INSERTION LOSS, RETURN LOSS, AND ISOLATION

$V_{DD} = 3.3\text{ V}$ ,  $V_{SS} = -3.3\text{ V}$ ,  $V_{CTRL} = 0\text{ V}$  or  $V_{DD}$ , and  $T_{CASE} = 25^\circ\text{C}$ , and a  $50\ \Omega$  system, unless otherwise noted. RFx refers to RF1 to RF2.

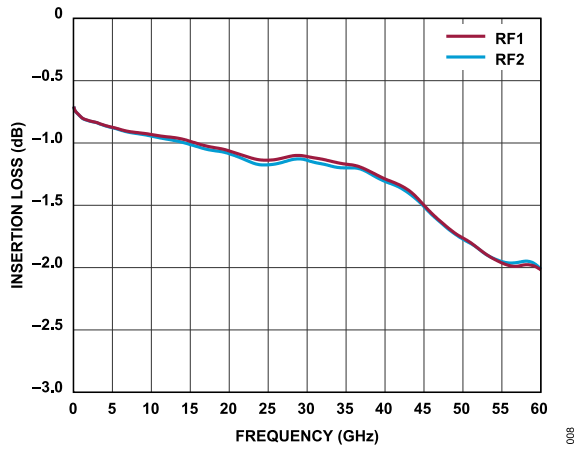

Figure 8. Insertion Loss vs. Frequency RF1 and RF2

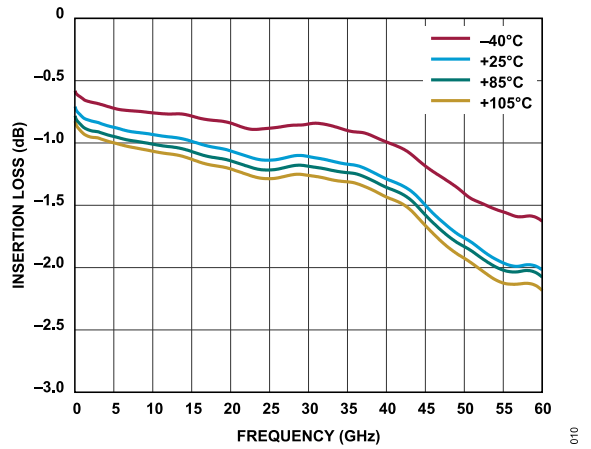

Figure 10. Insertion Loss vs. Frequency over Various Temperatures

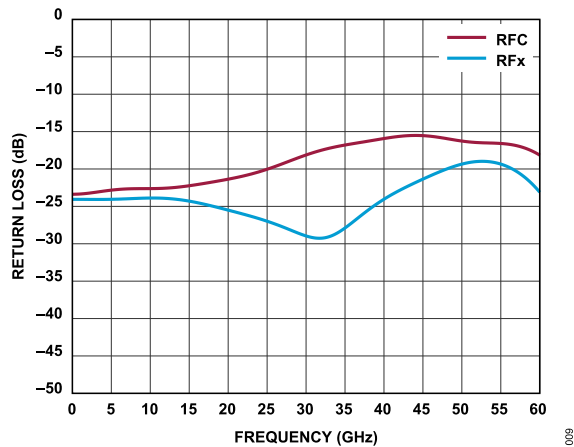

Figure 9. Return Loss vs. Frequency

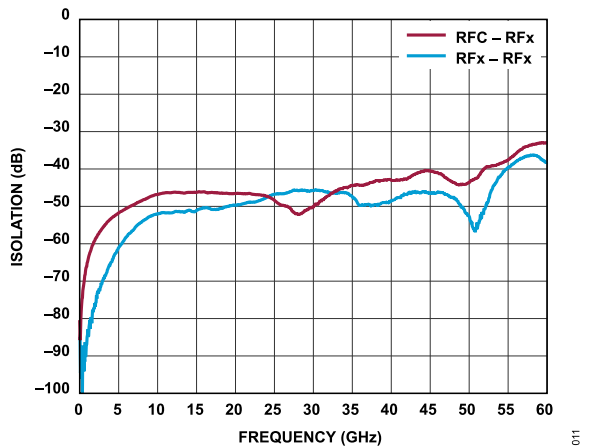

Figure 11. Isolation vs. Frequency

TYPICAL PERFORMANCE CHARACTERISTICS

INPUT POWER COMPRESSION AND THIRD-ORDER INTERCEPT

$V_{DD} = 3.3\text{ V}$ ,  $V_{SS} = -3.3\text{ V}$ ,  $V_{CTRL} = 0\text{ V}$  or  $V_{DD}$ , and  $T_{CASE} = 25^\circ\text{C}$  for a  $50\ \Omega$  system, unless otherwise noted.

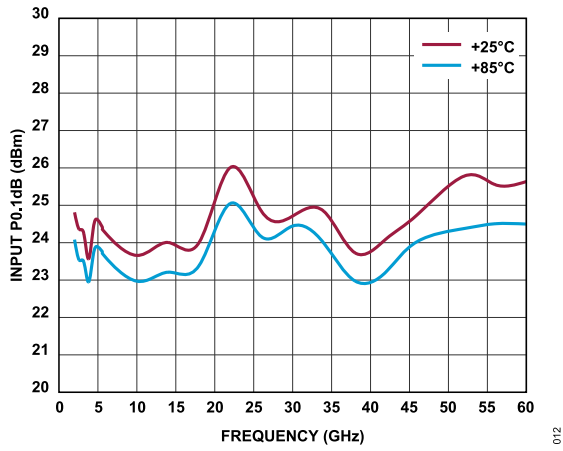

Figure 12. Input P0.1dB vs. Frequency

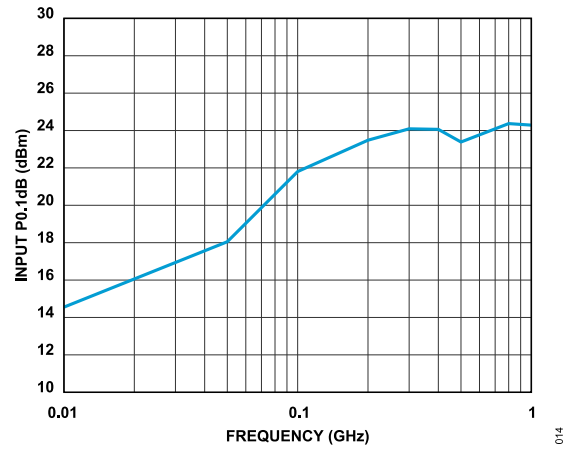

Figure 14. Input P0.1dB vs. Frequency (Low-Frequency Detail)

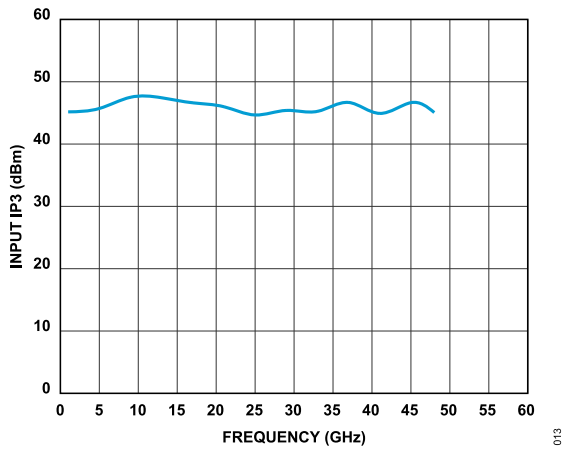

Figure 13. Input IP3 vs. Frequency

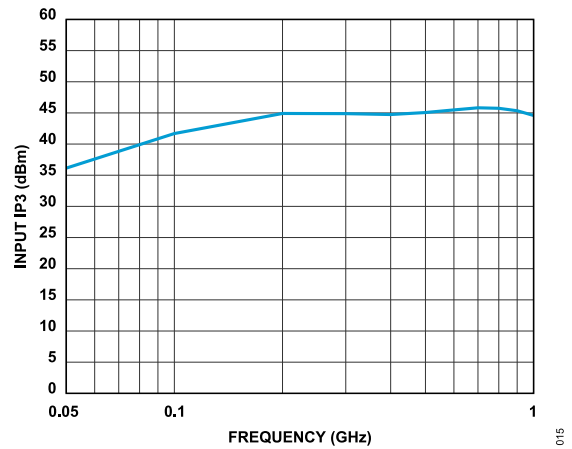

Figure 15. Input IP3 vs. Frequency (Low-Frequency Detail)



## THEORY OF OPERATION

The ADRF5032 can connect to CMOS/LVTTL-compatible control interfaces directly. The CTRL pin determines which RF port is in the insertion loss state and in the isolation state. See [Table 7](#) for the control voltage truth table.

### RF INPUT AND OUTPUT

The RF ports (RFC, RF1, and RF2) are DC-coupled to 0 V, and no DC-blocking is required at the RF ports when the RF line potential is equal to 0 V. The RF ports are internally matched to 50  $\Omega$ .

The ADRF5032 is bidirectional with equal power-handling capabilities. The RF input signal can be applied to the RFC port or the selected RF throw port.

The insertion loss path conducts the RF signal between the selected RF throw port and the RF common port. The isolation paths provide high loss between the insertion loss path and the unselected RF throw port. The unselected RF port of the ADRF5032 is reflective.

The power handling of the ADRF5032 derates with frequencies below 3 GHz. See [Figure 2](#) for derating of the RF power towards lower frequencies.

**Table 7. Control Voltage Truth Table**

Digital Control Input	RF Path	
	RF1 to RFC	RF2 to RFC
Low	Isolation (off)	Insertion loss (on)
High	Insertion loss (on)	Isolation (off)

## POWER SUPPLY

The ADRF5032 requires that a positive supply voltage is applied to the VDD pin and a negative supply voltage to the VSS pin. Bypassing capacitors are recommended on the supply lines to minimize RF coupling.

The ideal power-up sequence is as follows:

1. Connect GND.
2. Power up VDD and VSS. Power up VSS after VDD to avoid current transients on VDD during ramp up.
3. Apply digital control inputs. The relative order of the control inputs is not important. However, powering the digital control inputs before the VDD supply can inadvertently forward bias and damage the internal ESD protection structures. To avoid this damage, use a series 1 k $\Omega$  resistor to limit the current flowing into the control pin. Use pull-up or pull-down resistors if the controller is in a high impedance state after VDD is powered up and the control pins are not driven to a valid logic state.
4. Apply RF input signal.

The ideal power-down sequence is the reverse of the above.

**APPLICATIONS INFORMATION**

The ADRF5032 has two power-supply pins (VDD and VSS) and one control pin (CTRL). Figure 16 shows the external components and connections for the supply pin. The VDD and VSS pins are decoupled with a 100 pF multilayer ceramic capacitor. The device pinout allows the placement of the decoupling capacitors close to the device. No other external components are needed for bias and operation, except DC-blocking capacitors on the RF pins when the RF lines are biased at a voltage other than 0 V. See Table 6 for details.

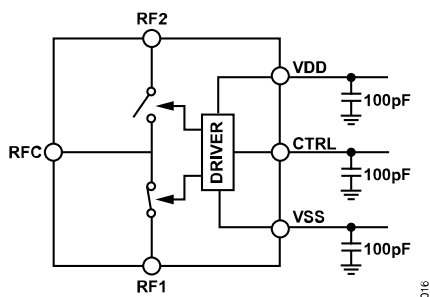

Figure 16. Recommended Schematic

**RECOMMENDATIONS FOR PRINTED CIRCUIT BOARD DESIGN**

The RF ports are matched to 50 Ω internally and the pinout is designed to mate a coplanar waveguide (CPWG) with 50 Ω characteristic impedance on the PCB. Figure 17 shows the referenced CPWG RF trace design for an RF substrate with 8 mil thick Rogers RO4003C dielectric material. RF trace with 16 mil width and 13 mil clearance is recommended for 1.7 mil finished copper thickness.

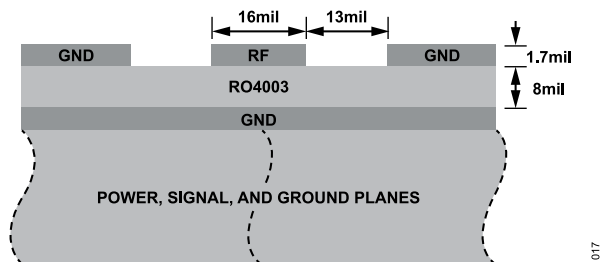

Figure 17. Example PCB Stack-up

Figure 18 shows the routing of the RF traces, supply, and control signals from the device. The ground planes are connected with densely filled through vias for optimal RF and thermal performance. The primary thermal path for the device is the bottom side.

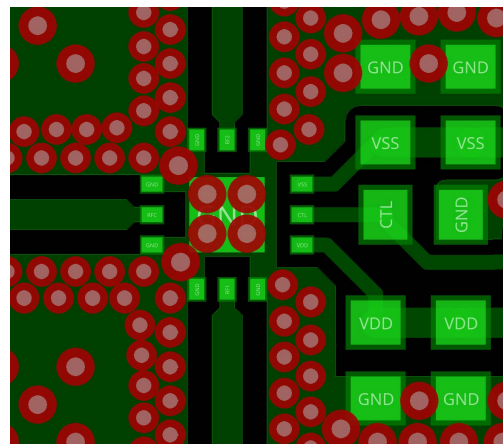

Figure 18. PCB Layout

Figure 19 shows the recommended layout from the device RF pins to the 50 Ω CPWG on the referenced stack-up. PCB pads are drawn 1:1 to device pads. The ground pads are drawn soldermask defined and the signal pads are drawn as pad defined. The RF trace from the PCB pad is extended with the same width to the package edge and tapered to RF trace. The paste mask is designed to match the device pads without any aperture reduction. The paste mask is divided into multiple openings for the paddle.

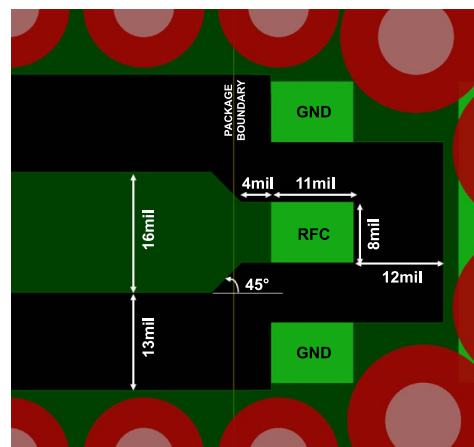
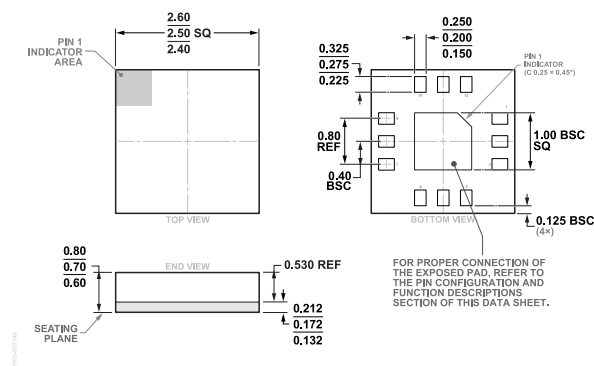

Figure 19. Recommended RF Pin Transition

For alternate PCB stack-ups with different dielectric thickness and RF trace design, contact Analog Devices Technical Support for further recommendations.

## OUTLINE DIMENSIONS



**Figure 20. 12-Terminal Land Grid Array [LGA]  
2.5 mm × 2.5 mm Body and 0.7 mm Package Height (CC-12-7)  
Dimensions Shown in Millimeters**

Updated: May 25, 2023

## ORDERING GUIDE

Model <sup>1</sup>	Temperature Range	Package Description	Packing Quantity	Package Option
ADRF5032BCCZN	-40°C to +105°C	12-terminal LGA (2.5 mm x 2.5 mm x 0.70 mm)	Reel, 1500	CC-12-7
ADRF5032BCCZN-R7	-40°C to +105°C	12-terminal LGA (2.5 mm x 2.5 mm x 0.70 mm)	Reel, 1500	CC-12-7

<sup>1</sup> Z = RoHS Compliant Part.