

## FEATURES

**Ultrawide common-mode range:**  $-V_S - 0.1\text{ V}$  to  $-V_S + 70\text{ V}$   
**Wide power supply voltage range:** ( $V_{SV}$ ):  $+3.15\text{ V}$  to  $+50\text{ V}$  ( $\pm 25\text{ V}$  for PSRR)  
**Low supply current:** 1.5 mA (typical)  
**Low input offset voltage:**  $\pm 30\ \mu\text{V}$  maximum  
**Low input offset voltage drift:**  $\pm 0.4\ \mu\text{V}/^\circ\text{C}$  maximum  
**Low voltage noise:**  
   1/f noise corner: 6 Hz typical  
   150 nV p-p typical at 0.1 Hz to 10 Hz  
   7 nV/ $\sqrt{\text{Hz}}$  typical at 100 Hz ( $e_n$ )  
**High speed**  
   GBP: 8 MHz typical  
   Slew rate: 5.5 V/ $\mu\text{s}$  typical at  $\Delta V_{OUT} = 25\text{ V}$   
**Low power shutdown:** 20  $\mu\text{A}$  maximum  
**Low input bias current:**  $\pm 10\text{ nA}$  maximum  
**Large signal voltage gain:** 120 dB minimum  
**CMRR:** 123 dB, minimum  
**PSRR:** 126 dB, minimum  
**Input overdrive tolerant with no phase reversal**  
 $\pm 2\text{ kV HBM}$  and  $\pm 2\text{ kV FICDM}$   
**Wide temperature range:**  $-55^\circ\text{C}$  to  $+150^\circ\text{C}$  (H grade)  
**6-lead TSOT package**

## APPLICATIONS

Industrial sensor conditioning  
 Supply current sensing  
 Battery and power supply monitoring  
 Front-end amplifiers in abusive environments  
 4 mA to 20 mA transmitters

## GENERAL DESCRIPTION

The ADA4099-1 is a robust, precision, rail-to-rail input/output operational amplifier (op amp) with inputs that operate from  $-V_S$  to  $+V_S$  and beyond, which is referred to in this data sheet as Over-The-Top™. The device features offset voltages of  $<30\ \mu\text{V}$ , input bias currents ( $I_B$ ) of  $<10\text{ nA}$ , and can operate on single or split supplies that range from 3.15 V to 50 V. The ADA4099-1 draws 1.5 mA of quiescent current.

The ADA4099-1 Over-The-Top input stage has robust input protection features for abusive environments. The inputs can tolerate up to 80 V of differential voltage without damage or degradation to dc accuracy. The operating input common-mode range extends from rail-to-rail and beyond, up to  $70\text{ V} > -V_S$ , independent of the  $+V_S$  supply.

The ADA4099-1 is unity-gain stable and can drive loads requiring up to 20 mA. The device can also drive capacitive loads as large as 100 pF. The amplifier is available with low power shutdown.

The ADA4099-1 is available in a standard, 6-lead, thin small outline transistor (TSOT) package.

## TYPICAL APPLICATION CIRCUIT

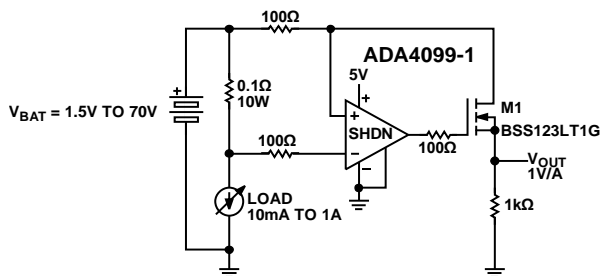

Figure 1. 1 V/A Over-The-Top™ Current Sense Application

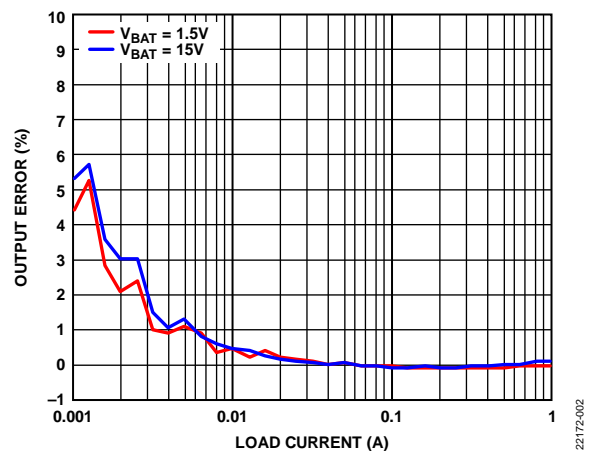

Figure 2. Output Error vs. Load Current

Rev. 0

[Document Feedback](#)

Information furnished by Analog Devices is believed to be accurate and reliable. However, no responsibility is assumed by Analog Devices for its use, nor for any infringements of patents or other rights of third parties that may result from its use. Specifications subject to change without notice. No license is granted by implication or otherwise under any patent or patent rights of Analog Devices. Trademarks and registered trademarks are the property of their respective owners.

One Technology Way, P.O. Box 9106, Norwood, MA 02062-9106, U.S.A.  
 Tel: 781.329.4700 ©2021 Analog Devices, Inc. All rights reserved.  
[Technical Support](#) [www.analog.com](http://www.analog.com)

## TABLE OF CONTENTS

Features .....	1	Output.....	19
Applications.....	1	Shutdown Pin (SHDN).....	19
General Description .....	1	Applications Information .....	20
Typical Application Circuit .....	1	Large Resistor Gain Operation .....	20
Revision History .....	2	Recommended Values for Various Gains.....	20
Specifications.....	3	Noise .....	21
5 V Supply.....	3	Distortion .....	21
±15 V Supply.....	5	Power Dissipation and Thermal Shutdown.....	22
Absolute Maximum Ratings.....	7	Circuit Layout Considerations .....	22
Maximum Power Dissipation .....	7	Power Supply Bypassing.....	22
Thermal Resistance .....	7	Grounding.....	22
Electrostatic Discharge (ESD) Ratings .....	7	ESD Protection when Powered.....	23
ESD Caution.....	7	Related Products.....	23
Pin Configuration and Function Descriptions.....	8	Typical Applications.....	24
Typical Performance Characteristics .....	9	Outline Dimensions .....	26
Theory of Operation .....	17	Ordering Guide .....	26
Input Protection.....	18		
Over-The-Top Operation Considerations .....	18		

## REVISION HISTORY

1/2021—Revision 0: Initial Version

## SPECIFICATIONS

## 5 V SUPPLY

Common-mode voltage ( $V_{CM}$ ) = 2.5 V, SHDN pin is open, load resistance ( $R_L$ ) = 499 k $\Omega$  to midsupply, ambient temperature ( $T_A$ ) = 25°C, unless otherwise noted.

Table 1.

Parameter	Test Conditions/Comments	B Grade			H Grade			Unit
		Min	Typ	Max	Min	Typ	Max	
DC PERFORMANCE								
Input Offset Voltage ( $V_{OS}$ ) <sup>1</sup>	0.25 V < $V_{CM}$ < 3.25 V		±10	±30		±10	±30	μV
	Minimum temperature ( $T_{MIN}$ ) < $T_A$ < maximum temperature ( $T_{MAX}$ )			±90			±90	μV
	0.25 V < $V_{CM}$ < 70 V		±25	±65		±25	±65	μV
	$T_{MIN}$ < $T_A$ < $T_{MAX}$			±125			±140	μV
	−0.1 V < $V_{CM}$ < +70 V		±25	±70		±25	±70	μV
Input Offset Voltage Drift <sup>2</sup>	$T_{MIN}$ < $T_A$ < $T_{MAX}$			±125			±175	μV
	$T_{MIN}$ < $T_A$ < $T_{MAX}$		±0.1	±0.4		±0.1	±0.8	μV/°C
Input Bias Current ( $I_B$ )			±4	±10		±4	±10	nA
	$T_{MIN}$ < $T_A$ < $T_{MAX}$			±15			±30	nA
	$V_{CM}$ = 70 V, Over-The-Top	70	82.5	95	70	82.5	95	μA
	$T_{MIN}$ < $T_A$ < $T_{MAX}$	40		125	40		125	μA
	0 V < $V_{CM}$ < 70 V, $V_{SY}$ = 0 V		0.001	10		0.001	10	μA
Input Offset Current ( $I_{OS}$ )	$T_{MIN}$ < $T_A$ < $T_{MAX}$			25			25	μA
			±2	±4		±2	±4	nA
	$T_{MIN}$ < $T_A$ < $T_{MAX}$			±8			±10	nA
	$V_{CM}$ = 70 V, Over-The-Top <sup>3</sup>		±0.5	±2		±0.5	±2	μA
	$T_{MIN}$ < $T_A$ < $T_{MAX}$			±5			±5	μA
Common-Mode Rejection Ratio (CMRR)	$V_{CM}$ = −0.1 V to +70 V	123	136		123	136		dB
	$T_{MIN}$ < $T_A$ < $T_{MAX}$	115			110			dB
	$V_{CM}$ = 0.25 V to 3.25 V	114	132		114	132		dB
Common-Mode Input Range	$T_{MIN}$ < $T_A$ < $T_{MAX}$	110			110			dB
	Guaranteed by CMRR tests	− $V_S$ − 0.1		− $V_S$ + 70	− $V_S$ − 0.1		− $V_S$ + 70	V
Large Signal Voltage Gain ( $A_{OL}$ )	$\Delta V_{OUT}$ = 4 V	126	140		126	140		dB
	$T_{MIN}$ < $T_A$ < $T_{MAX}$	116			110			dB
	$\Delta V_{OUT}$ = 4 V, $R_L$ = 10 k $\Omega$	120	130		120	130		dB
	$T_{MIN}$ < $T_A$ < $T_{MAX}$	110			102			dB
NOISE PERFORMANCE								
Input Voltage Noise	Frequency (f) = 0.1 Hz to 10 Hz		150			150		nV p-p
	1/f noise corner		6			6		Hz
	f = 100 Hz		7			7		nV/√Hz
Over-The-Top	f = 100 Hz, $V_{CM}$ > 5 V		8			8		nV/√Hz
Input Current Noise	f = 100 Hz		0.5			0.5		pA/√Hz
	Over-The-Top	f = 100 Hz, $V_{CM}$ > 5 V		5		5		pA/√Hz
DYNAMIC PERFORMANCE								
Slew Rate	$\Delta V_{OUT}$ = 2 V	2.7	4		2.7	4		V/μs
	$T_{MIN}$ < $T_A$ < $T_{MAX}$	1.75			1.75			V/μs
Gain Bandwidth Product (GBP)	Test frequency ( $f_{TEST}$ ) = 25 kHz	7.5	8		7.5	8		MHz
	$T_{MIN}$ < $T_A$ < $T_{MAX}$	6.75			6.5			MHz
Phase Margin			47			47		Degrees
1% Settling Time	$\Delta V_{OUT}$ = ±2 V		1.15			1.15		μs
0.1% Settling Time	$\Delta V_{OUT}$ = ±2 V		1.5			1.5		μs
Total Harmonic Distortion Plus Noise (THD + N)	f = 10 kHz, $V_{OUT}$ = 2 V p-p, $R_L$ = 10 k $\Omega$ , bandwidth = 80 kHz		0.001			0.001		%

Parameter	Test Conditions/Comments	B Grade			H Grade			Unit
		Min	Typ	Max	Min	Typ	Max	
<b>INPUT CHARACTERISTICS</b>								
Input Resistance	Differential mode		100			100		kΩ
	Common mode		>1			>1		GΩ
Over-The-Top	Differential mode, $V_{CM} > 5\text{ V}$		600			600		Ω
	Common mode, $V_{CM} > 5\text{ V}$		>100			>100		MΩ
Input Capacitance	Differential mode		9			9		pF
	Common mode		3			3		pF
<b>SHDN PIN</b>								
Input Logic Low	Amplifier active, SHDN pin voltage ( $V_{SHDN}$ ) < $-V_S + 0.5\text{ V}$ , $T_{MIN} < T_A < T_{MAX}$			$-V_S + 0.5$		$-V_S + 0.5$		V
Input Logic High	Amplifier shutdown, $V_{SHDN} > -V_S + 1.5\text{ V}$ , $T_{MIN} < T_A < T_{MAX}$	$-V_S + 1.5$			$-V_S + 1.5$			V
Response Time	Amplifier active to shutdown		2.5			2.5		μs
	Amplifier shutdown to active		10			10		μs
Pull-Down Current	$V_{SHDN} = -V_S + 0.5\text{ V}$ , $T_{MIN} < T_A < T_{MAX}$		0.6	3		0.6	3	μA
	$V_{SHDN} = -V_S + 1.5\text{ V}$ , $T_{MIN} < T_A < T_{MAX}$		0.3	2.5		0.3	2.5	μA
<b>OUTPUT CHARACTERISTICS</b>								
Output Voltage Swing Low	Overdrive voltage ( $V_{OD}^4$ ) = 30 mV, no load		45	55		45	55	mV
	$T_{MIN} < T_A < T_{MAX}$			105			120	mV
	$V_{OD} = 30\text{ mV}$ , sink current, ( $I_{SINK}$ ) = 10 mA		260	325		260	325	mV
	$T_{MIN} < T_A < T_{MAX}$			435			450	mV
Output Voltage Swing High	$V_{OD} = 30\text{ mV}$ , no load		45	55		45	55	mV
	$T_{MIN} < T_A < T_{MAX}$			110			140	mV
	$V_{OD} = 30\text{ mV}$ , source current, ( $I_{SOURCE}$ ) = 10 mA		900	1100		900	1100	mV
	$T_{MIN} < T_A < T_{MAX}$			1500			1650	mV
Short-Circuit Current	$I_{SOURCE}$	20	30		20	30		mA
	$T_{MIN} < T_A < T_{MAX}$	15			15			mA
	$I_{SINK}$	40	50		40	50		mA
	$T_{MIN} < T_A < T_{MAX}$	20			20			mA
Output Pin Leakage During Shutdown	$V_{SHDN} = -V_S + 1.5\text{ V}$		±0.01	±100		±0.01	±100	nA
	$T_{MIN} < T_A < T_{MAX}$			±10			±10	μA
<b>POWER SUPPLY</b>								
Maximum Operating Voltage <sup>5</sup>				50			50	V
Voltage Range	Guaranteed by power supply rejection ratio (PSRR)	3.15		50	3.15		50	V
Supply Current	Amplifier active		1.5	1.6		1.5	1.6	mA
	$T_{MIN} < T_A < T_{MAX}$			2.2			2.35	mA
	Amplifier shutdown $V_{SHDN} = -V_S + 1.5\text{ V}$		12	20		12	20	μA
	$T_{MIN} < T_A < T_{MAX}$			22.5			22.5	μA
PSRR	$V_{SY} = 3.15\text{ V}$ to ±25 V	126	136		126	136		dB
	$T_{MIN} < T_A < T_{MAX}$	122			120			dB
<b>THERMAL SHUTDOWN<sup>6</sup></b>								
Temperature	Junction temperature ( $T_J$ )		175			175		°C
Hysteresis			20			20		°C
Operating Temperature	Ambient temperature ( $T_A$ )	-40		+125	-55		+150	°C

<sup>1</sup> Thermoelectric voltages present in the high speed production test limit the measurement accuracy of this parameter. The limits shown in Table 1 are determined by test capability and are not necessarily indicative of actual device performance.

<sup>2</sup> Offset voltage drift is guaranteed through lab characterization and is not production tested.

<sup>3</sup> Test accuracy is limited by high speed production test equipment repeatability. Bench measurements indicate that the input offset current in Over-The-Top configuration is typically controlled to under 250 nA at +25°C and 1000 nA over the -55°C <  $T_A$  < +150°C temperature range.

<sup>4</sup>  $V_{OD}$  is +30 mV for  $V_{OUT}$  high and -30 mV for  $V_{OUT}$  low.

<sup>5</sup> Maximum operating voltage is limited by the time-dependent dielectric breakdown (TDDb) of on-chip capacitor oxides. The amplifier tolerates temporary transient overshoot up to the specified absolute maximum rating, but the dc supply voltage must be limited to the maximum operating voltage.

<sup>6</sup> Thermal shutdown is lab characterized only and is not tested in production.

**±15 V SUPPLY**

$V_{CM} = 0$  V, SHDN pin is open,  $R_L = 499$  k $\Omega$  to ground, and  $T_A = 25^\circ\text{C}$ , unless otherwise noted.

**Table 2.**

Parameter	Test Conditions/Comments	B Grade			H Grade			Unit
		Min	Typ	Max	Min	Typ	Max	
<b>DC PERFORMANCE</b>								
Input Offset Voltage ( $V_{OS}$ ) <sup>1</sup>	$T_{MIN} < T_A < T_{MAX}$ $V_{SY} = \pm 25$ V $T_{MIN} < T_A < T_{MAX}$		$\pm 12$	$\pm 30$		$\pm 12$	$\pm 30$	$\mu\text{V}$
				$\pm 95$		$\pm 90$		$\mu\text{V}$
			$\pm 15$	$\pm 35$		$\pm 15$	$\pm 35$	$\mu\text{V}$
				$\pm 105$		$\pm 90$		$\mu\text{V}$
Input Offset Voltage Drift <sup>2</sup>	$T_{MIN} < T_A < T_{MAX}$		$\pm 0.1$	$\pm 0.4$		$\pm 0.1$	$\pm 0.9$	$\mu\text{V}/^\circ\text{C}$
Input Bias Current	$T_{MIN} < T_A < T_{MAX}$ $V_{SY} = \pm 25$ V $T_{MIN} < T_A < T_{MAX}$		$\pm 4$	$\pm 10$		$\pm 4$	$\pm 10$	nA
				$\pm 25$			$\pm 60$	nA
			$\pm 4$	$\pm 10$		$\pm 4$	$\pm 10$	nA
				$\pm 35$			$\pm 100$	nA
Input Offset Current	$T_{MIN} < T_A < T_{MAX}$ $V_{SY} = \pm 25$ V $T_{MIN} < T_A < T_{MAX}$		$\pm 2$	$\pm 5$		$\pm 2$	$\pm 5$	nA
				$\pm 15$			$\pm 30$	nA
			$\pm 4$	$\pm 5$		$\pm 4$	$\pm 5$	nA
				$\pm 20$			$\pm 35$	nA
CMRR	$V_{CM} = -14.75$ V to $+13.25$ V $T_{MIN} < T_A < T_{MAX}$	118	130		118	130		dB
		113			115			dB
	$V_{CM} = -15.1$ V to $+13.25$ V $T_{MIN} < T_A < T_{MAX}$	115	126		115	126		dB
		108			104			dB
	$V_{CM} = -15.1$ V to $+55$ V $T_{MIN} < T_A < T_{MAX}$	117	126		117	126		dB
		114			110			dB
Common-Mode Input Range	Guaranteed by CMRR tests	-15.1		+55	-15.1		+55	V
$A_{OL}$	$\Delta V_{OUT} = 25$ V $T_{MIN} < T_A < T_{MAX}$ $\Delta V_{OUT} = 25$ V, $R_L = 10$ k $\Omega$ $T_{MIN} < T_A < T_{MAX}$	134	154		134	154		dB
		120			116			dB
		120	134		120	134		dB
		114			110			dB
<b>NOISE PERFORMANCE</b>								
Input Voltage Noise	$f = 0.1$ Hz to 10 Hz 1/f noise corner $f = 100$ Hz		150			150		nV p-p
				6		6		Hz
				7		7		nV/ $\sqrt{\text{Hz}}$
Over-The-Top	$f = 100$ Hz, $V_{CM} > +V_S$		8			8		nV/ $\sqrt{\text{Hz}}$
Input Current Noise	$f = 100$ Hz $f = 100$ Hz, $V_{CM} > +V_S$		0.5			0.5		pA/ $\sqrt{\text{Hz}}$
				5		5		pA/ $\sqrt{\text{Hz}}$
<b>DYNAMIC PERFORMANCE</b>								
Slew Rate	$\Delta V_{OUT} = 25$ V $T_{MIN} < T_A < T_{MAX}$	3.5	5.5		3.5	5.5		V/ $\mu\text{s}$
		2.6			2.6			V/ $\mu\text{s}$
GBP	$f_{TEST} = 25$ kHz $T_{MIN} < T_A < T_{MAX}$	7.5	8		7.5	8		MHz
		6.75			6.5			MHz
Phase Margin			57			57		Degrees
1% Settling Time	$\Delta V_{OUT} = \pm 2$ V		1.15			1.15		$\mu\text{s}$
0.1% Settling Time	$\Delta V_{OUT} = \pm 2$ V		1.5			1.5		$\mu\text{s}$
THD + N	$f = 10$ kHz, $V_{OUT} = 5.6$ V p-p, $R_L = 10$ k $\Omega$ , bandwidth = 80 kHz		0.001			0.001		%
<b>INPUT CHARACTERISTICS</b>								
Input Resistance	Differential mode		100			100		k $\Omega$
	Common mode		>1			>1		G $\Omega$
Input Capacitance	Differential mode		9			9		pF
	Common mode		3			3		pF

Parameter	Test Conditions/Comments	B Grade			H Grade			Unit
		Min	Typ	Max	Min	Typ	Max	
<b>SHDN PIN</b>								
Input Logic Low	Amplifier active, $V_{SHDN} < -V_S + 0.5\text{ V}$			$-V_S + 0.5$			$-V_S + 0.5$	V
Input Logic High	Amplifier shutdown, $V_{SHDN} > -V_S + 1.5\text{ V}$	$-V_S + 1.5$			$-V_S + 1.5$			V
Response Time	Amplifier active to shutdown		2.5			2.5		$\mu\text{s}$
Pull-Down Current	Amplifier shutdown to active		10			10		$\mu\text{s}$
	$V_{SHDN} = -V_S + 0.5\text{ V}, T_{MIN} < T_A < T_{MAX}$		0.6	3		0.6	3	$\mu\text{A}$
	$V_{SHDN} = -V_S + 1.5\text{ V}, T_{MIN} < T_A < T_{MAX}$		0.3	2.5		0.3	2.5	$\mu\text{A}$
<b>OUTPUT CHARACTERISTICS</b>								
Output Voltage Swing Low	$V_{OD}^3 = 30\text{ mV}$ , no load		45	60		45	60	mV
	$T_{MIN} < T_A < T_{MAX}$			115			125	mV
	$V_{OD} = 30\text{ mV}$ , $I_{SINK} = 10\text{ mA}$		260	325		260	325	mV
	$T_{MIN} < T_A < T_{MAX}$			435			450	mV
Output Voltage Swing High	$V_{OD} = 30\text{ mV}$ , no load		45	55		45	55	mV
	$T_{MIN} < T_A < T_{MAX}$			140			165	mV
	$V_{OD} = 30\text{ mV}$ , $I_{SOURCE} = 10\text{ mA}$		900	1100		900	1100	mV
	$T_{MIN} < T_A < T_{MAX}$			1500			1650	mV
Short-Circuit Current	$I_{SOURCE}$	25	34		25	34		mA
	$T_{MIN} < T_A < T_{MAX}$	20			20			mA
	$I_{SINK}$	40	50		40	50		mA
	$T_{MIN} < T_A < T_{MAX}$	20			20			mA
<b>POWER SUPPLY</b>								
Maximum Operating Voltage <sup>4</sup>				50			50	V
Voltage Range Supply Current	Guaranteed by PSRR	3.15		50	3.15		50	V
	Amplifier active		1.65	1.8		1.65	1.8	mA
	$T_{MIN} < T_A < T_{MAX}$			2.45			2.6	mA
	$V_{SY} = \pm 25\text{ V}$		1.75	2		1.75	2	mA
	$T_{MIN} < T_A < T_{MAX}$			2.7			2.85	mA
	Amplifier shutdown, $V_{SHDN} = -V_S + 1.5\text{ V}$		17	24		17	24	$\mu\text{A}$
PSRR	$T_{MIN} < T_A < T_{MAX}$			27			27	$\mu\text{A}$
	$V_{SY} = 3.15\text{ V to } 50\text{ V}$	126	136		126	136		dB
	$T_{MIN} < T_A < T_{MAX}$	122			120			dB
<b>THERMAL SHUTDOWN<sup>5</sup></b>								
Temperature	$T_J$		175			175		$^{\circ}\text{C}$
Hysteresis			20			20		$^{\circ}\text{C}$
Operating Temperature	$T_A$	-40		+125	-55		+150	$^{\circ}\text{C}$

<sup>1</sup> Thermoelectric voltages present in the high speed production test limit the measurement accuracy of this parameter. The limits shown in Table 2 are determined by test capability and are not necessarily indicative of actual device performance.

<sup>2</sup> Offset voltage drift is guaranteed through lab characterization and is not production tested.

<sup>3</sup>  $V_{OD}$  is +30 mV for  $V_{OUT}$  high and -30 mV for  $V_{OUT}$  low.

<sup>4</sup> Maximum operating voltage is limited by the TDDB of on-chip capacitor oxides. The amplifier tolerates temporary transient overshoot up to the specified absolute maximum rating and the dc supply voltage must be limited to the maximum operating voltage.

<sup>5</sup> Thermal shutdown is lab characterized only and is not tested in production.

# ABSOLUTE MAXIMUM RATINGS

Table 3.

Parameter	Rating
Supply Voltage <sup>1</sup>	
Transient	60 V
Continuous	50 V
Power Dissipation (P <sub>D</sub> )	See Figure 3
Differential Input Voltage	±80 V
±IN Pin Voltage	
Continuous	-5 V to +80 V
Survival	-10 V to +80 V
±IN Pin Current	20 mA
SHDN Pin Voltage	-0.3 V to +60 V
Storage Temperature Range	-65°C to +150°C
Operating Temperature Range	-55°C to +150°C
Lead Temperature (Soldering, 10 sec)	300°C
Junction Temperature (T <sub>J</sub> )	175°C

<sup>1</sup> Maximum supply voltage is limited by the TDDB of on-chip capacitor oxides. The amplifier tolerates temporary transient overshoot up to the specified transient maximum rating. The continuous operating supply voltage must be limited to no more than 50 V.

Stresses at or above those listed under Absolute Maximum Ratings may cause permanent damage to the device. This is a stress rating only; functional operation of the product at these or any other conditions above those indicated in the operational section of this specification is not implied. Operation beyond the maximum operating conditions for extended periods may affect product reliability.

Junction temperatures (T<sub>J</sub>) exceeding 125°C promote accelerated aging. The ADA4099-1 demonstrates ±25 V supply operation beyond 1400 hours at T<sub>A</sub> = 140°C.

## MAXIMUM POWER DISSIPATION

The maximum safe power dissipation (P<sub>D</sub>) on the device is limited by the associated rise in either case temperature (T<sub>C</sub>) or T<sub>J</sub> on the die. At approximately T<sub>C</sub> = 150°C, which is the glass transition temperature, the properties of the plastic changes. Exceeding this temperature limit, even temporarily, may change the stresses that the package exerts on the die, which permanently shifts the parametric performance of the ADA4099-1. Exceeding T<sub>J</sub> = 175°C for an extended period may result in changes in the silicon devices and may potentially cause failure of the device.

The P<sub>D</sub> on the package is the sum of the quiescent power dissipation and the power dissipated in the package due to the output load drive. The quiescent power is expressed in the following equation:

$$V_{SY} \times I_{SY}$$

where I<sub>SY</sub> is the quiescent current.

The P<sub>D</sub> due to the load drive depends on the application. The P<sub>D</sub> due to load drive is calculated by multiplying the load current by the associated voltage drop across the device. RMS voltages and currents must be used in these calculations.

Airflow increases heat dissipation, effectively reducing θ<sub>JA</sub>. Additional metal that is directly in contact with the package leads from metal traces through vias, ground, and power planes reduces θ<sub>JA</sub>.

Figure 3 shows the maximum P<sub>D</sub> vs. T<sub>A</sub> for the single and dual 6-lead TSOT packages on a JEDEC standard, 4-layer board, with -V<sub>S</sub> connected to a pad that is thermally connected to a printed circuit board (PCB) plane. θ<sub>JA</sub> values are approximations.

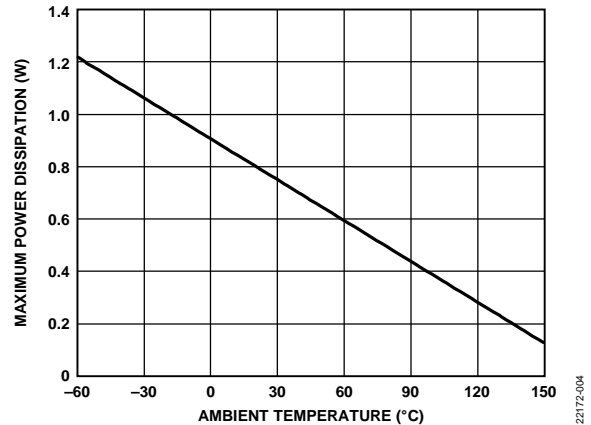

Figure 3. Maximum Power Dissipation vs. Ambient Temperature

## THERMAL RESISTANCE

Thermal performance is directly linked to PCB design and operating environment. Careful attention to PCB thermal design is required.

θ<sub>JA</sub> is the junction to ambient thermal resistance.

Table 4. Thermal Resistance

Package Type	θ <sub>JA</sub>	Unit
UJ-6	192	°C/W

## ELECTROSTATIC DISCHARGE (ESD) RATINGS

The following ESD information is provided for handling of ESD-sensitive devices in an ESD protected area only.

Human body model (HBM) per ANSI/ESDA/JEDEC JS-001.

Field induced charged device model (FICDM) per ANSI/ESDA/JEDEC JS-002.

### ESD Ratings for ADA4099-1

Table 5. ADA4099-1, 6-Lead TSOT

ESD Model	Withstand Threshold	Class
HBM	±2 kV	2
FICDM	±2 kV	3

## ESD CAUTION



**ESD (electrostatic discharge) sensitive device.** Charged devices and circuit boards can discharge without detection. Although this product features patented or proprietary protection circuitry, damage may occur on devices subjected to high energy ESD. Therefore, proper ESD precautions should be taken to avoid performance degradation or loss of functionality.

## PIN CONFIGURATION AND FUNCTION DESCRIPTIONS

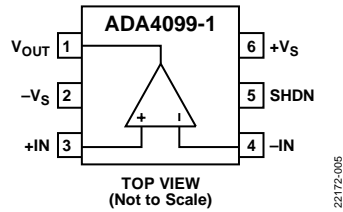

Figure 4. Pin Configuration

22172-005

Table 6. Pin Function Descriptions

Pin No.	Mnemonic	Description
1	V <sub>OUT</sub>	Amplifier Output.
2	-V <sub>S</sub>	Negative Power Supply. In single-supply applications, this pin is normally soldered to a low impedance ground plane. In split supply applications, bypass this pin with a capacitance of at least 0.1 μF to a low impedance ground plane, as close to the pin as possible.
3	+IN	Noninverting Input of the Amplifier.
4	-IN	Inverting Input of the Amplifier.
5	SHDN	Op Amp Shutdown. The threshold for shutdown is approximately 1 V above the negative supply. If this pin is not connected or hard tied to -V <sub>S</sub> , the amplifier is active. If asserted high (V <sub>SHDN</sub> > -V <sub>S</sub> + 1.5 V), the amplifier is placed in a shutdown state, and the output of the amplifier goes to a high impedance state. If this pin is left unconnected, it is recommended to connect a small capacitor of 1 nF between SHDN and -V <sub>S</sub> to prevent signals from -IN from capacitively coupling to the SHDN pin.
6	+V <sub>S</sub>	Positive Power Supply. Bypass this pin with a capacitance of at least 0.1 μF to a low impedance ground plane, as close to the pin as possible.



### TYPICAL PERFORMANCE CHARACTERISTICS

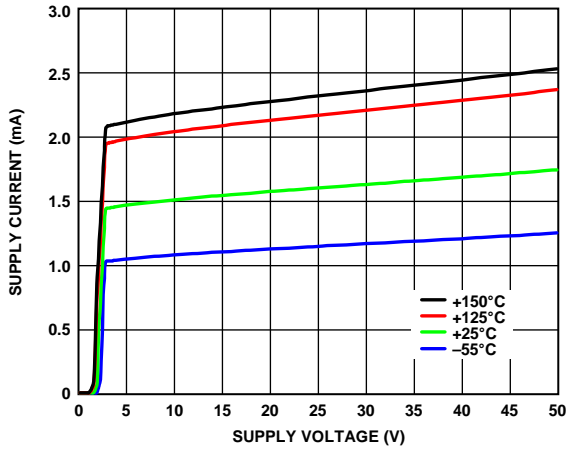

Figure 5. Supply Current vs. Supply Voltage

22172-006

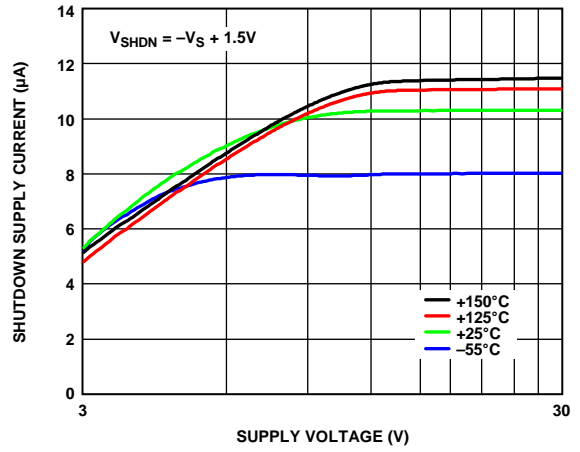

Figure 8. Shutdown Supply Current vs. Supply Voltage

22172-009

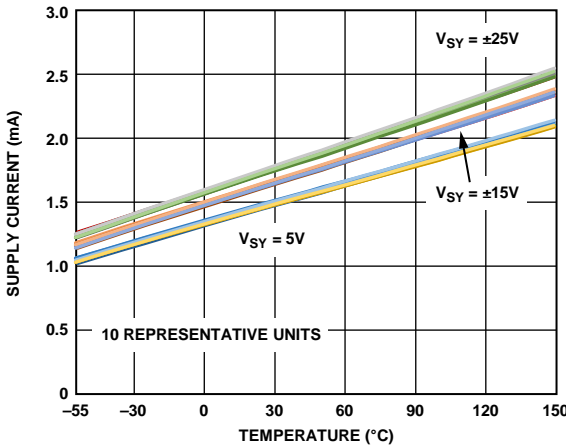

Figure 6. Supply Current vs. Temperature Across Various Supply Voltages

22172-007

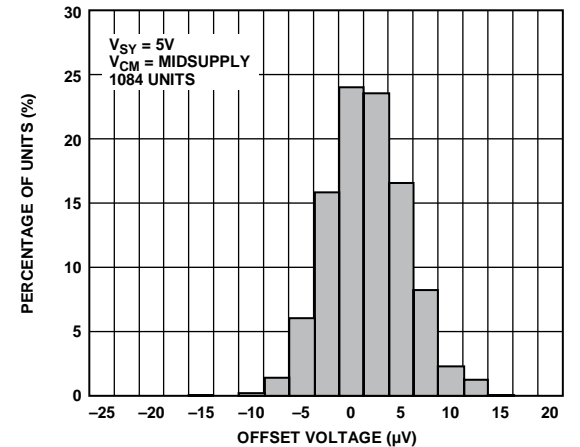

Figure 9. Typical Distribution of Input Offset Voltage,  $V_{SY} = 5V$

22172-010

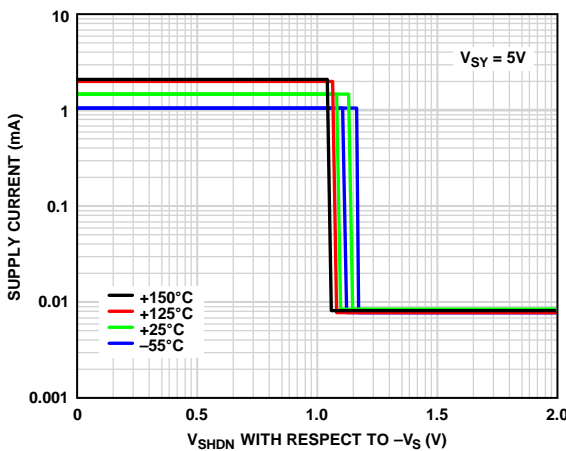

Figure 7. Supply Current vs.  $V_{SHDN}$  with Respect to  $-V_S$

22172-008

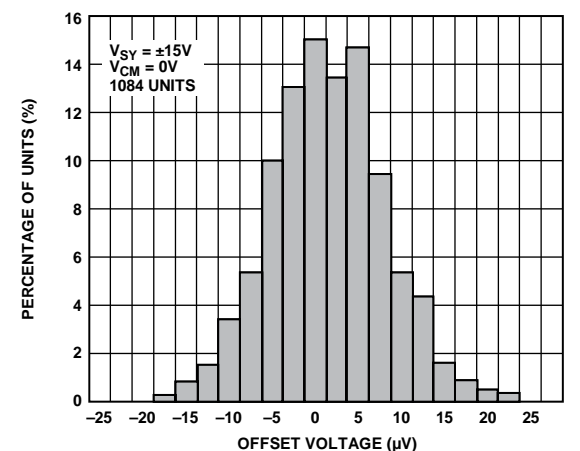

Figure 10. Typical Distribution of Input Offset Voltage with  $V_{SY} = \pm 15V$

22172-011

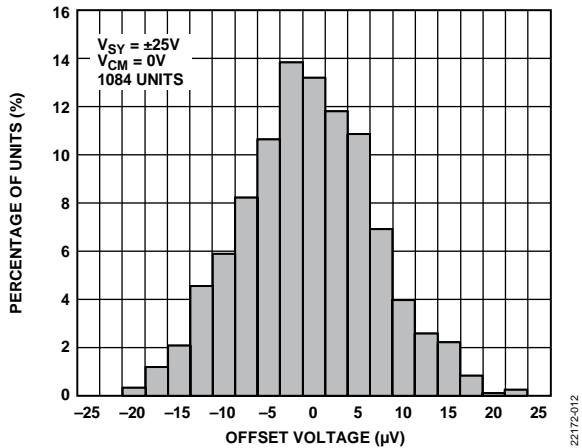

Figure 11. Typical Distribution of Input Offset Voltage with  $V_{SY} = \pm 25 V$

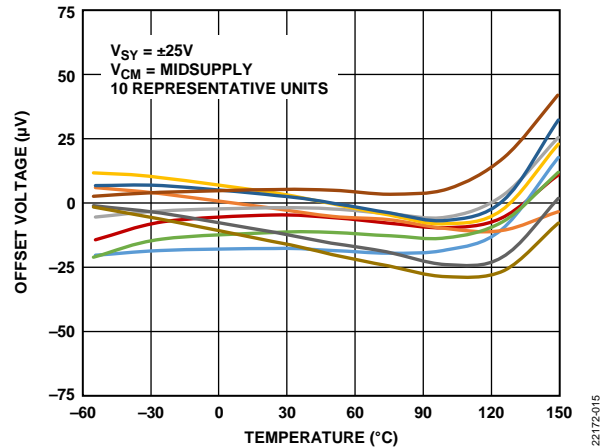

Figure 14. Offset Voltage vs. Temperature with  $V_{SY} = \pm 25 V$

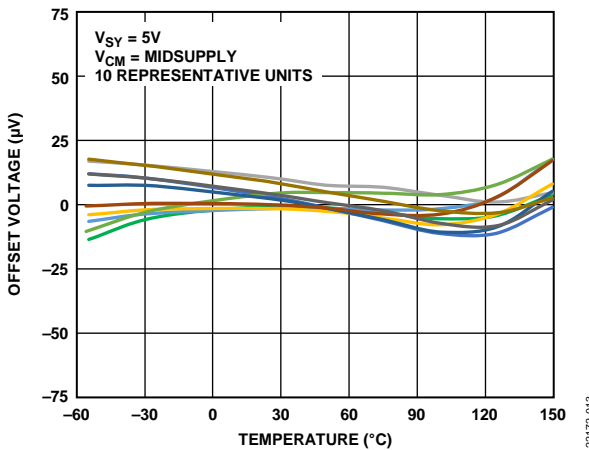

Figure 12. Offset Voltage vs. Temperature with  $V_{SY} = 5 V$

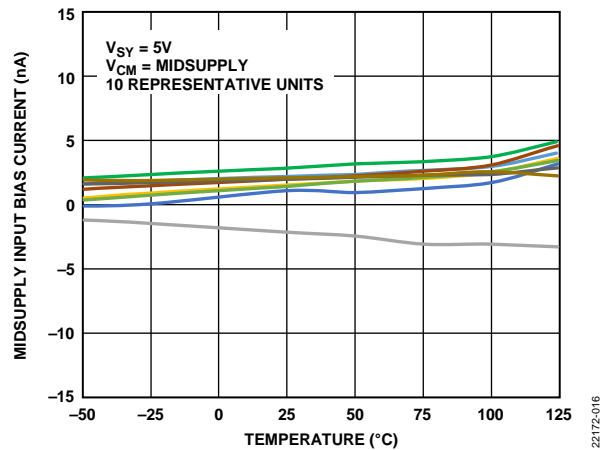

Figure 15. Midsupply Input Bias Current vs. Temperature with  $V_{SY} = 5 V$

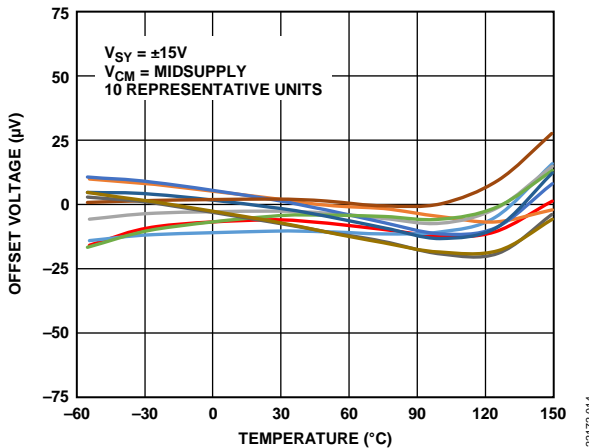

Figure 13. Offset Voltage vs. Temperature with  $V_{SY} = \pm 15 V$

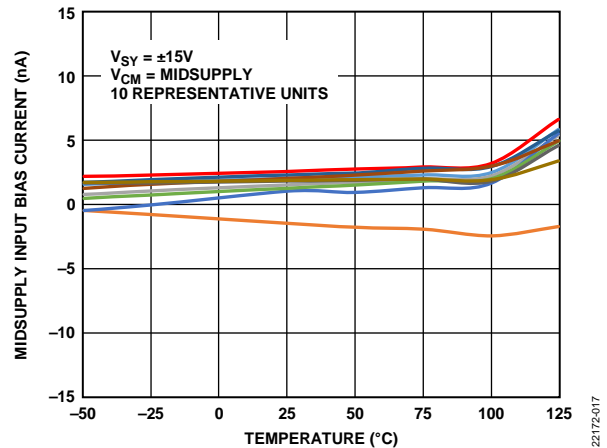

Figure 16. Midsupply Input Bias Current vs. Temperature with  $V_{SY} = \pm 15 V$

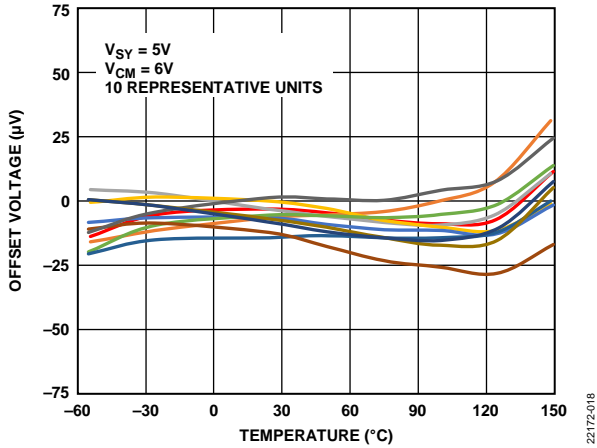

Figure 17. Offset Voltage vs. Temperature with  $V_{CM} = 6V$ , Over-The-Top

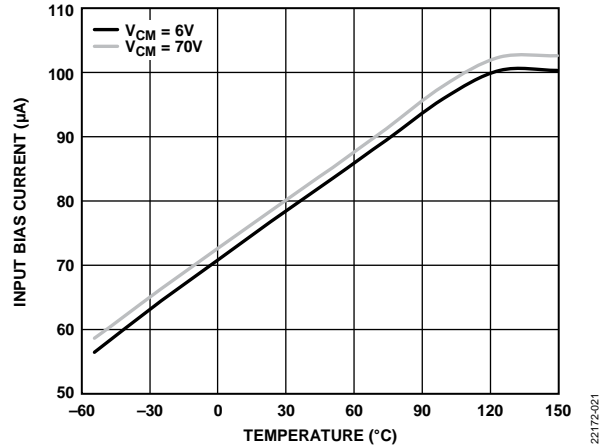

Figure 20. Input Bias Current vs. Temperature with  $V_{SY} = 5V$ , Over-The-Top

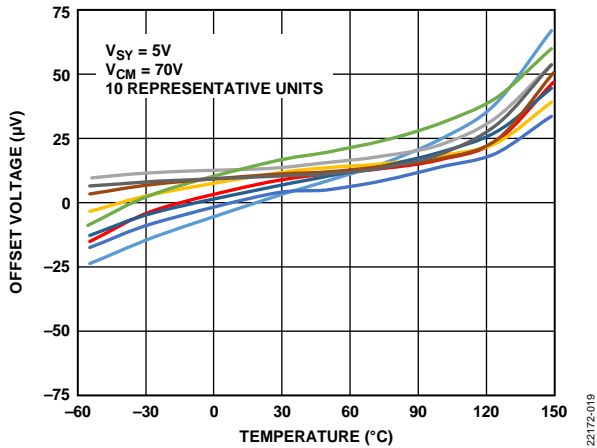

Figure 18. Offset Voltage vs. Temperature with  $V_{CM} = 70V$

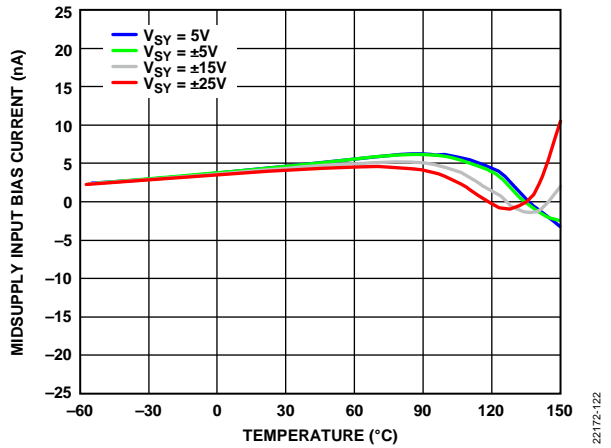

Figure 21. Midsupply Input Bias Current vs. Temperature Across Various Supply Voltages

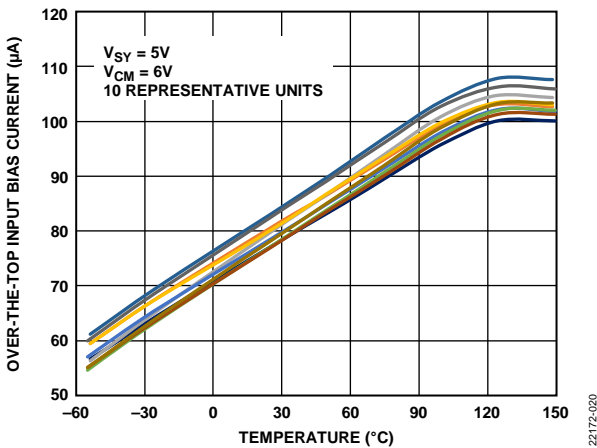

Figure 19. Over-The-Top Input Bias Current vs. Temperature with  $V_{CM} = 6V$

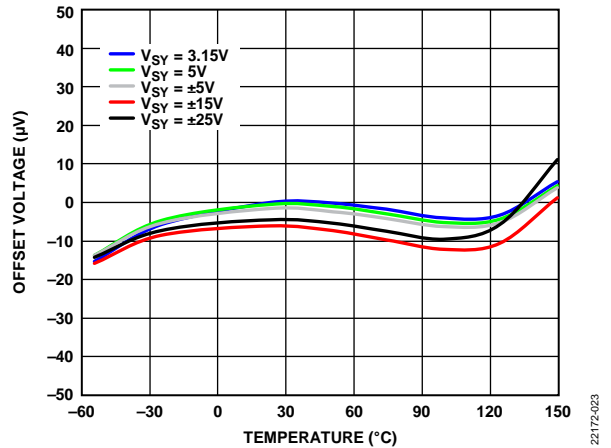

Figure 22. Offset Voltage vs. Temperature Across Various Supply Voltages

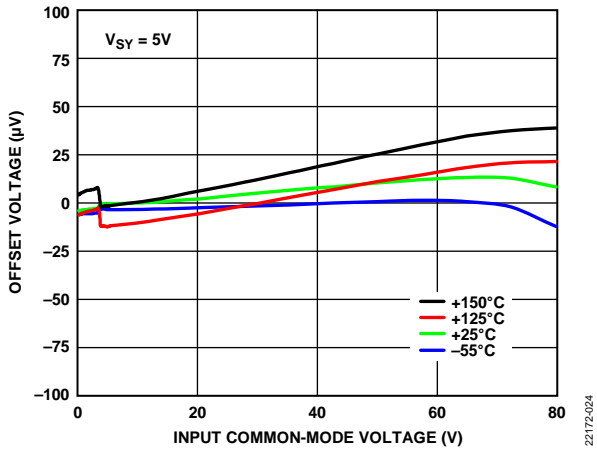

Figure 23. Offset Voltage vs. Input Common-Mode Voltage over the Input Common-Mode Range

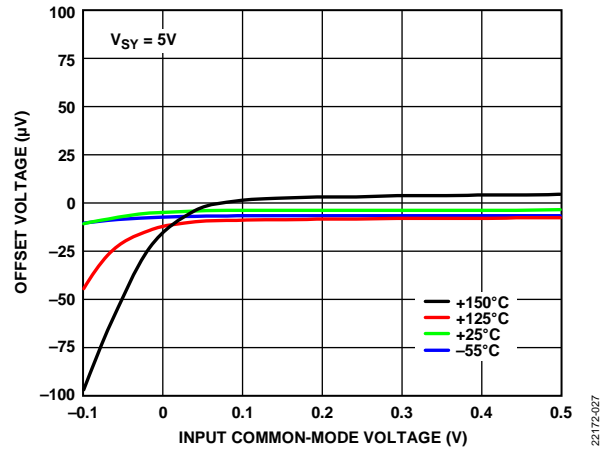

Figure 26. Offset Voltage vs. Input Common-Mode Voltage for Ground Sensing Applications

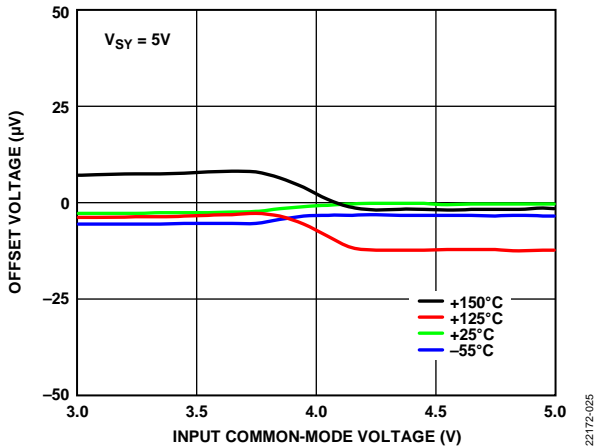

Figure 24. Offset Voltage vs. Input Common-Mode Voltage from Normal Operation to Over-The-Top Operation

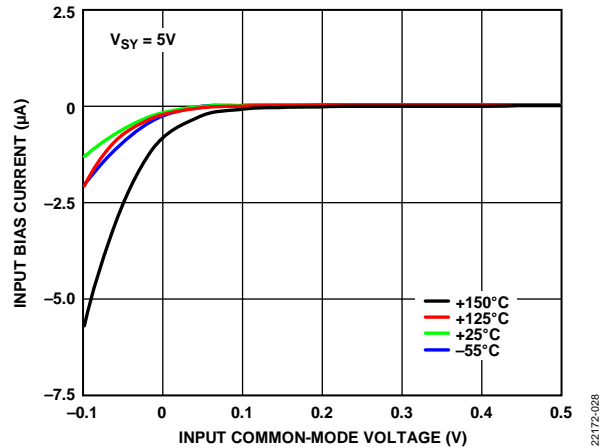

Figure 27. Input Bias Current vs. Input Common-Mode Voltage for Ground Sensing Applications

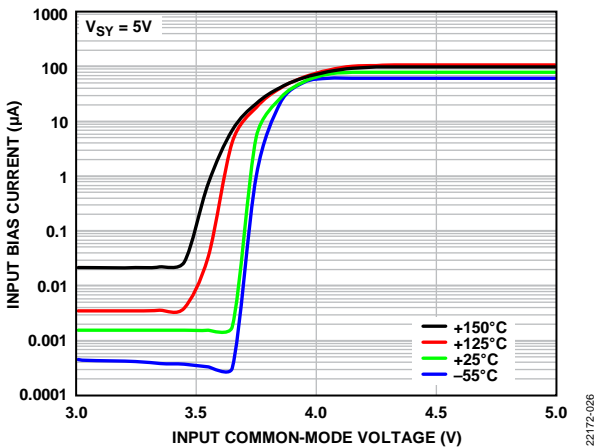

Figure 25. Input Bias Current vs. Input Common-Mode Voltage from Normal Operation to Over-The-Top Operation

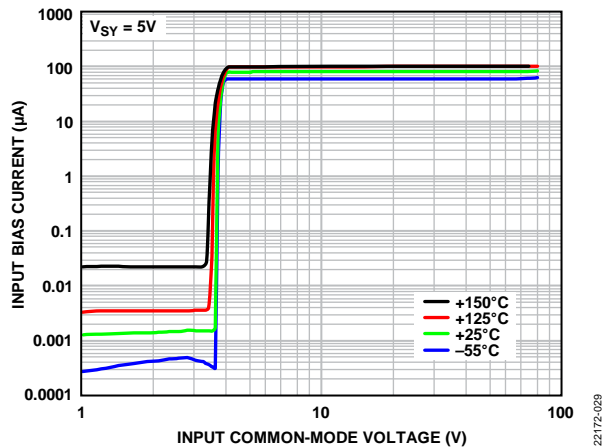

Figure 28. Input Bias Current vs. Input Common-Mode Voltage

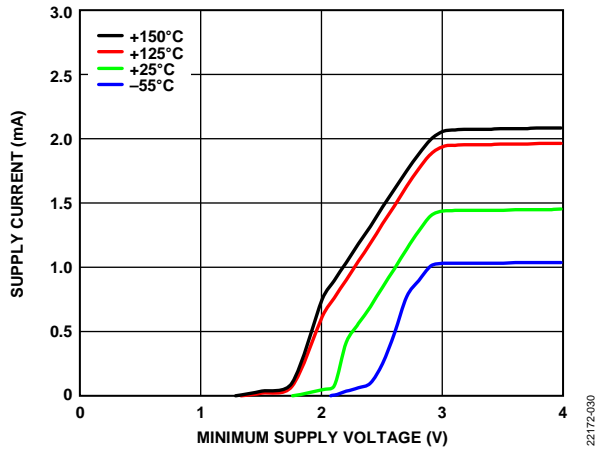

Figure 29. Supply Current vs. Minimum Supply Voltage

22172-030

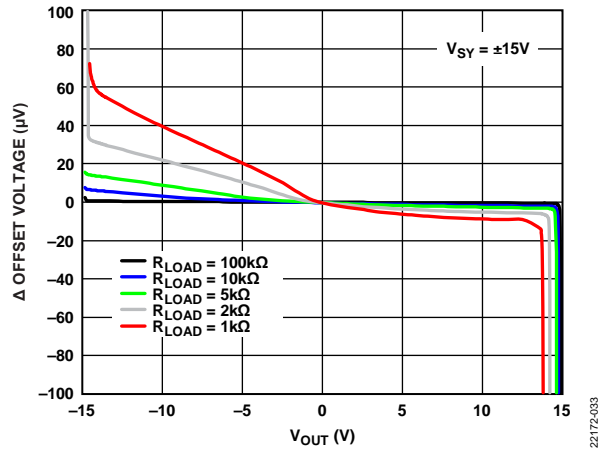

Figure 32. Δ Offset Voltage vs. Output Voltage ( $V_{OUT}$ )

22172-033

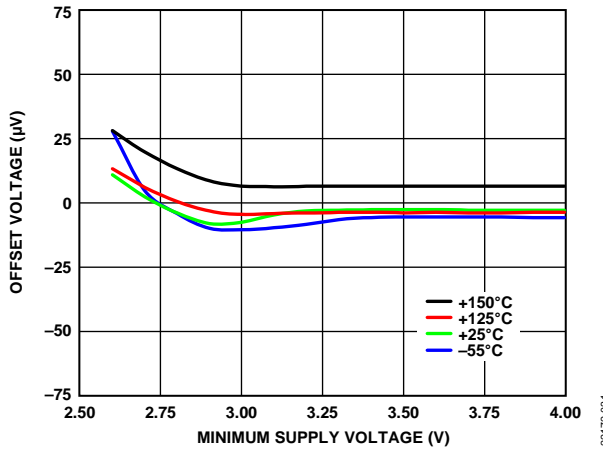

Figure 30. Offset Voltage vs. Minimum Supply Voltage

22172-031

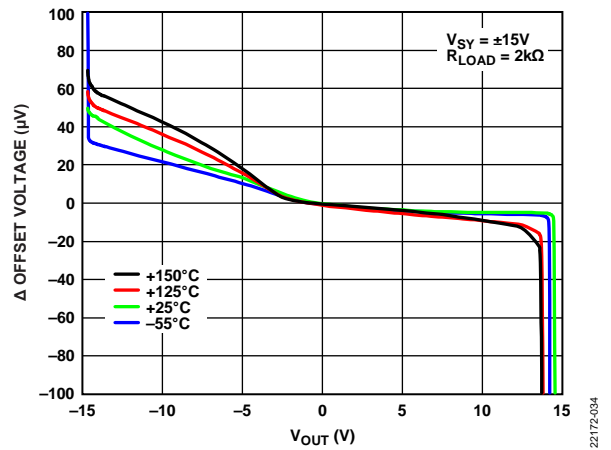

Figure 33. Δ Offset Voltage vs.  $V_{OUT}$  (2 kΩ Load)

22172-034

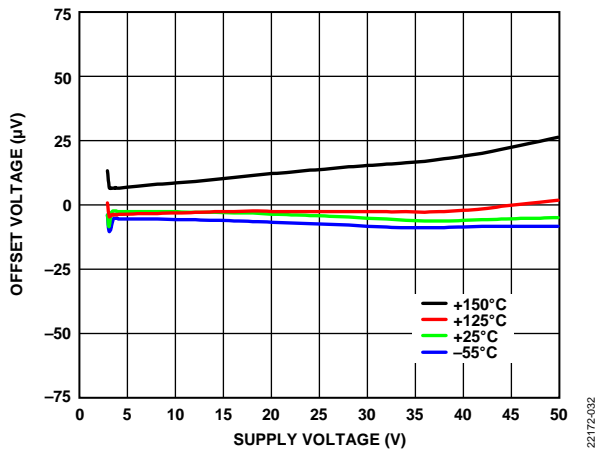

Figure 31. Offset Voltage vs. Supply Voltage

22172-032

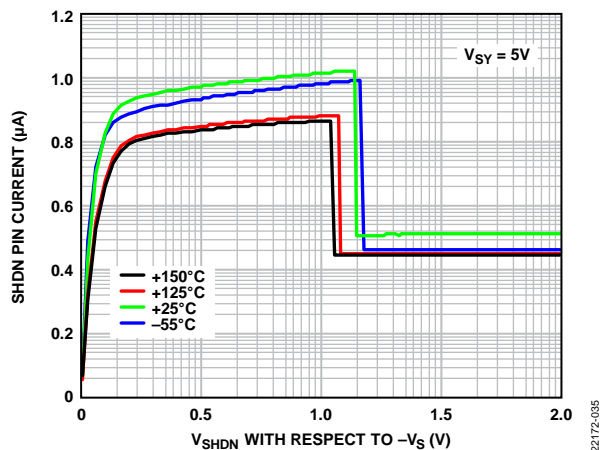

Figure 34. SHDN Pin Current vs.  $V_{SHDN}$  with Respect to  $-V_S$  over Various Temperatures

22172-035

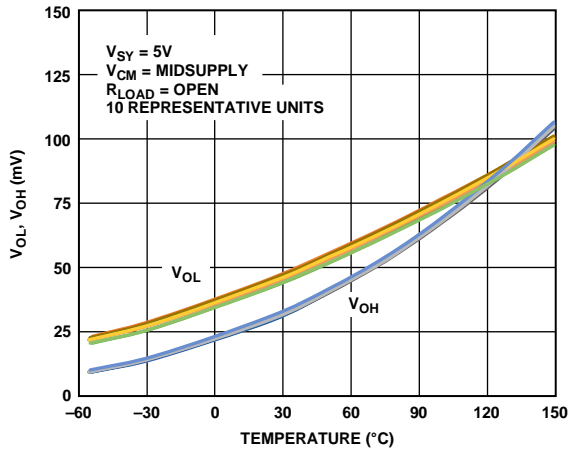

Figure 35. Output Voltage Low ( $V_{OL}$ ) and Output Voltage High ( $V_{OH}$ ) vs. Temperature

22172-036

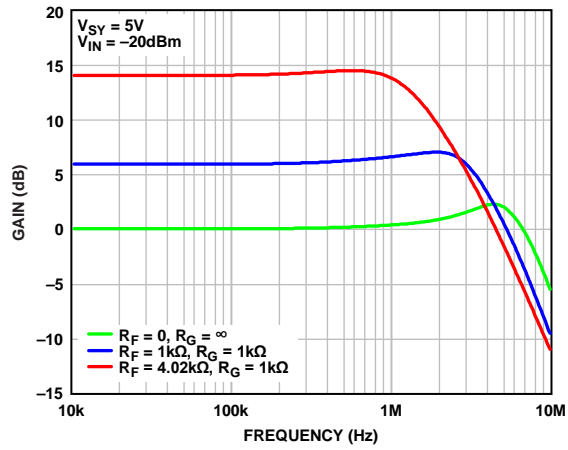

Figure 38. Noninverting Small Signal Frequency Response

22172-039

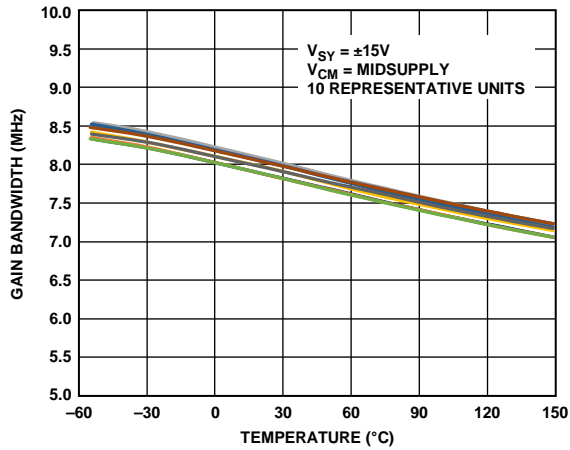

Figure 36. Gain Bandwidth vs. Temperature

22172-037

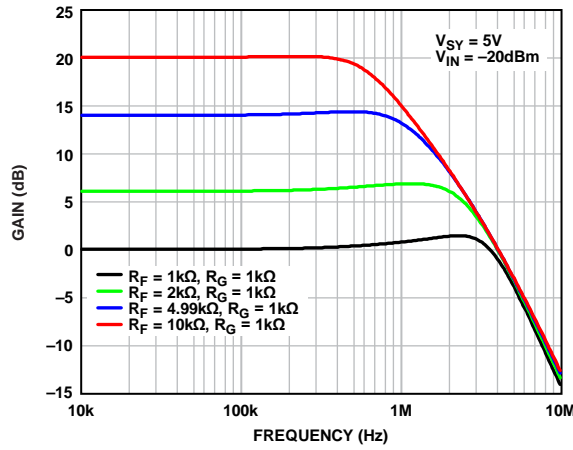

Figure 39. Inverting Small Signal Frequency Response

22172-040

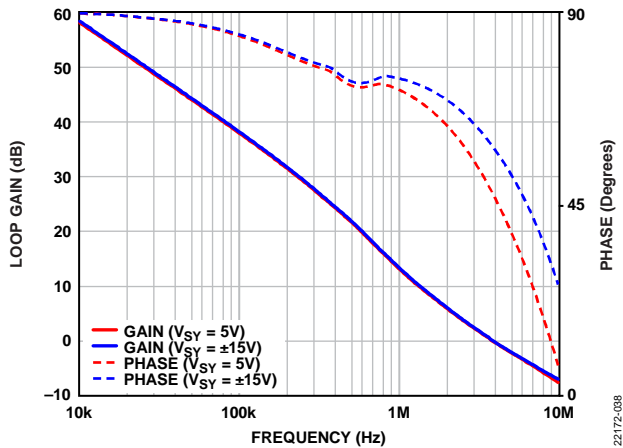

Figure 37. Loop Gain and Phase vs. Frequency

22172-038

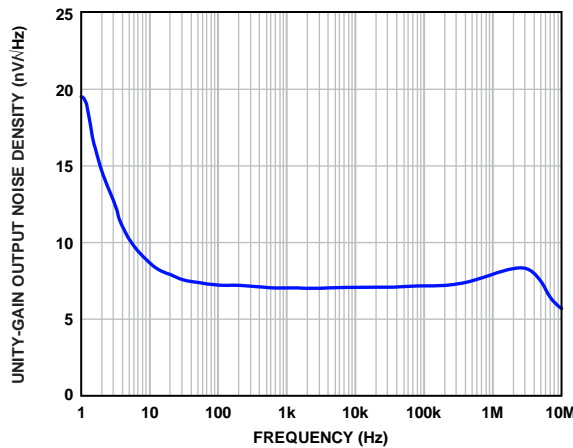

Figure 40. Unity-Gain Output Noise Density vs. Frequency

22172-041

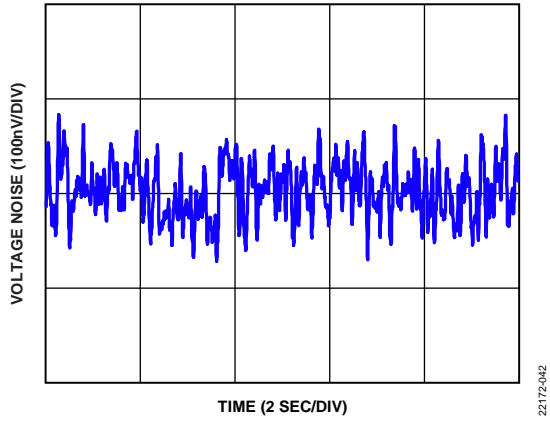

Figure 41. 0.1 Hz to 10 Hz Noise

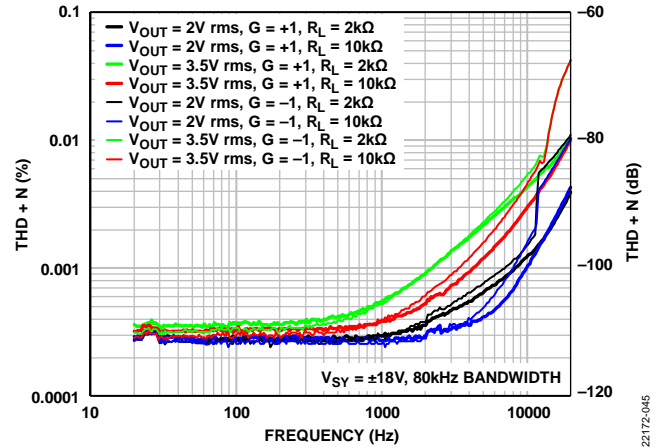

Figure 44. THD + N vs. Frequency over Load

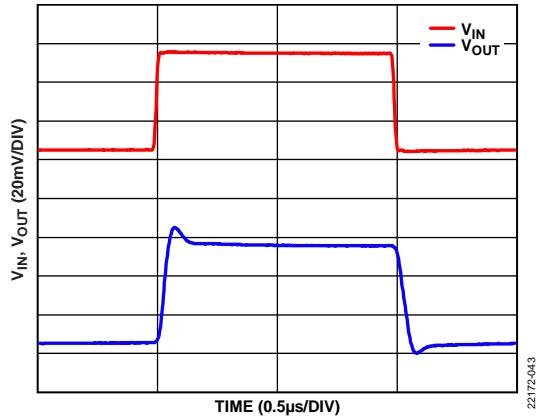

Figure 42. Unity-Gain Small Signal Step Response

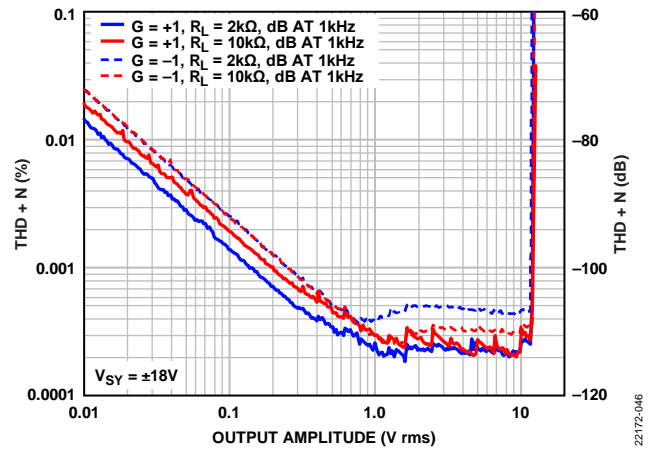

Figure 45. THD + N vs. Output Amplitude

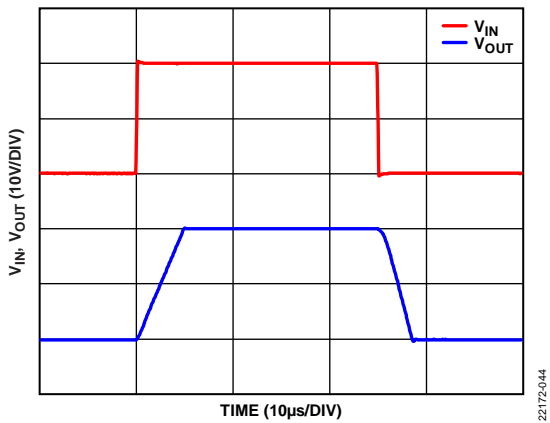

Figure 43. Unity-Gain Large Signal Step Response

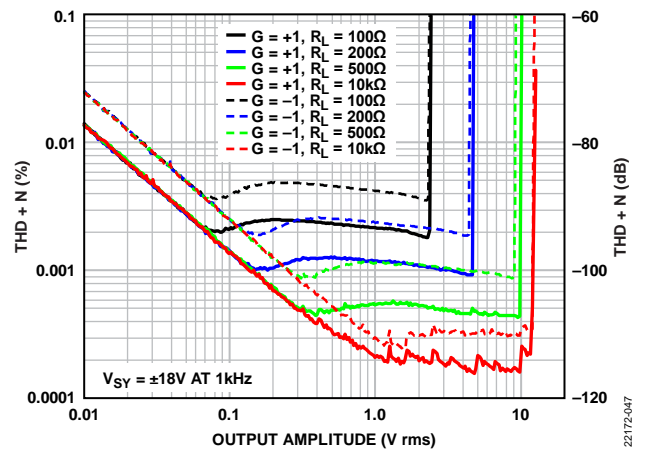

Figure 46. THD + N vs. Output Amplitude and Load

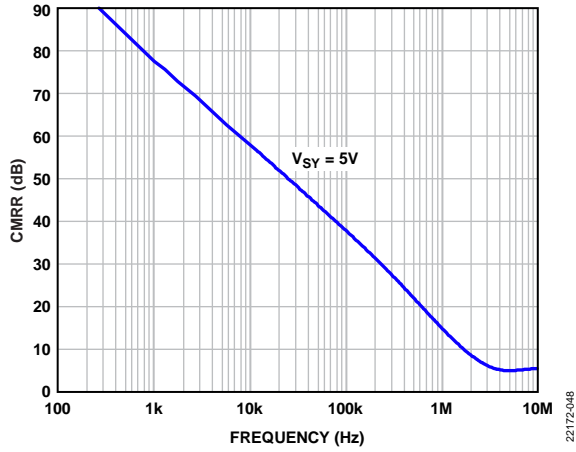

Figure 47. CMRR vs. Frequency

22172-048

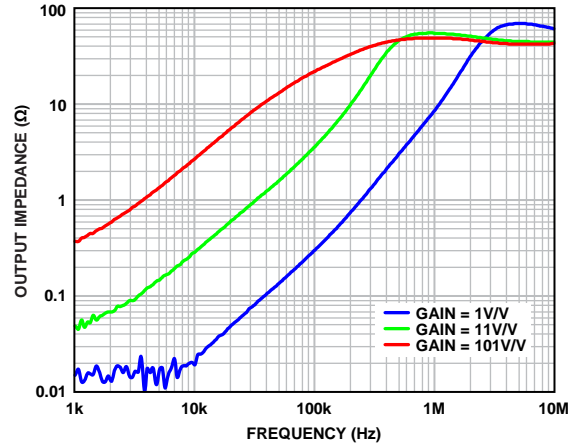

Figure 49. Output Impedance vs. Frequency

22172-050

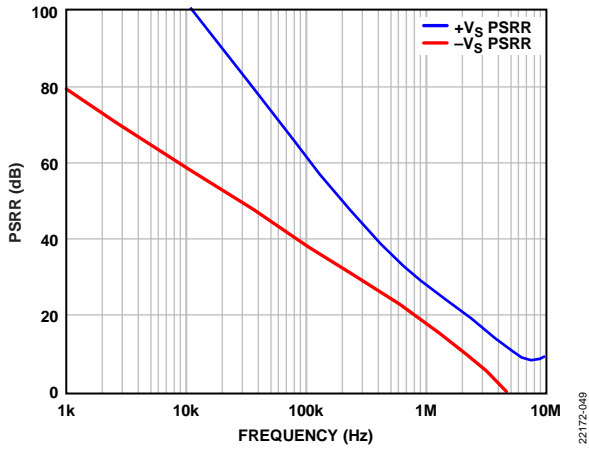

Figure 48. PSRR vs. Frequency

22172-049



# THEORY OF OPERATION

The ADA4099-1 is a robust, voltage feedback amplifier that combines unity-gain stability with low offset, low offset drift, and 7 nV/ $\sqrt{\text{Hz}}$  of input noise. Figure 52 shows a simplified schematic of the device. The ADA4099-1 has two input stages: a common emitter differential input stage consisting of the Q1 and Q2 PNP transistors that operate with the inputs biased between  $-V_S$  and 1.5 V below  $+V_S$ , and a common base input stage that consists of the Q3 to Q6 PNP transistors that operate when the common-mode input is biased  $>+V_S - 1.5$  V. These input stages result in two distinct operating regions, as shown in Figure 50.

For common-mode input voltages that are approximately 1.5 V below the  $+V_S$  supply, where Q1 and Q2 are active (see Figure 50), the common emitter PNP input stage is active and the input bias current is typically  $<4$  nA. When the common-mode input is above  $+V_S - 1.5$  V, the Q9 transistor turns on, which diverts bias current away from the common emitter differential input pair to the mirror that consists of M3 and M4. The current from M4 biases the common base differential input pair (Q3 to Q6). The Over-The-Top input pair operates in a common base configuration and the input bias current increases to  $\sim 82.5$   $\mu\text{A}$ . The offset voltages of both input stages are tightly trimmed and are specified in Table 1 and Table 2.

As the input common-mode transitions to the Over-The-Top region, the input CMRR degrades slightly when compared to the rest of the input common-mode range, as shown in Figure 51.

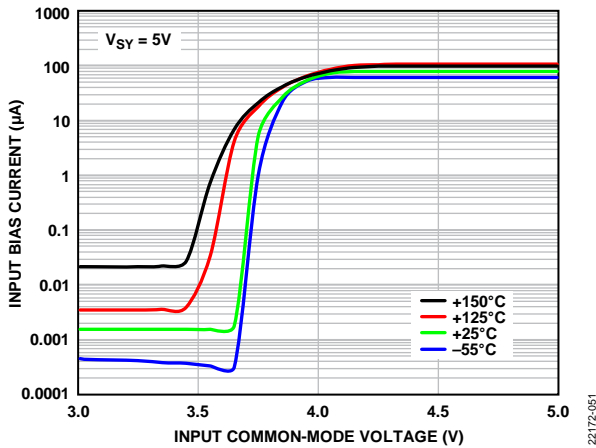

Figure 50. Input Bias Current vs. Input Common-Mode Voltage over Temperature,  $V_{SY} = 5$  V

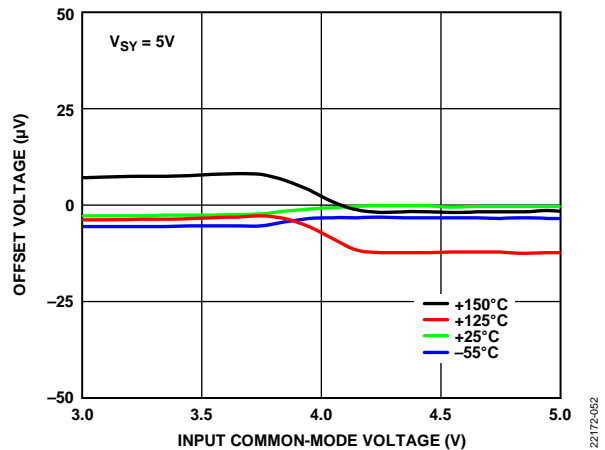

Figure 51. Offset Voltage vs. Input Common-Mode Voltage over Temperature,  $V_{SY} = 5$  V

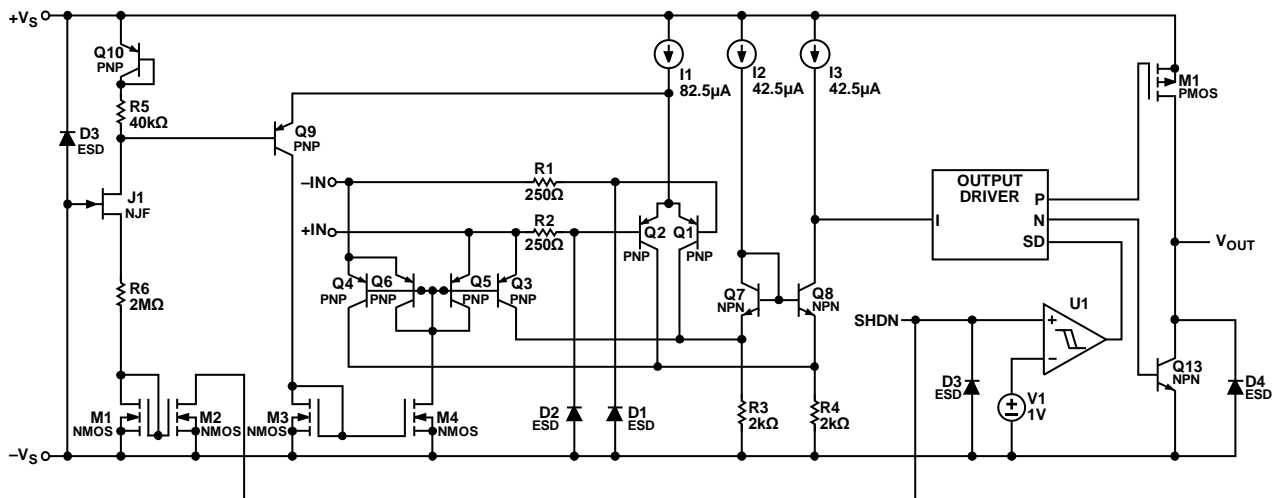

Figure 52. Simplified ADA4099-1 Schematic

**INPUT PROTECTION**

The inputs are protected against temporary voltage excursions to 10 V below  $-V_S$  (see Figure 53) by an internal 250  $\Omega$  resistor (see Figure 52). This resistor limits the current in the series D1 diode and D2 diode that are tied to the bases of the Q1 and Q2 transistors, respectively. Adding additional external series resistance extends the protection to  $>10$  V below  $-V_S$ , at the cost of stability and added thermal noise. The input stage of the ADA4099-1 incorporates phase reversal protection to prevent the output from phase reversing for inputs below  $-V_S$ . The ADA4099-1 op amp does not have clamping diodes between the inputs and can be differentially overdriven up to 80 V without damage, inducing parametric shifts, or drawing appreciable input current. Figure 54 summarizes the input fault types that can be applied to the ADA4099-1 without compromising input integrity.

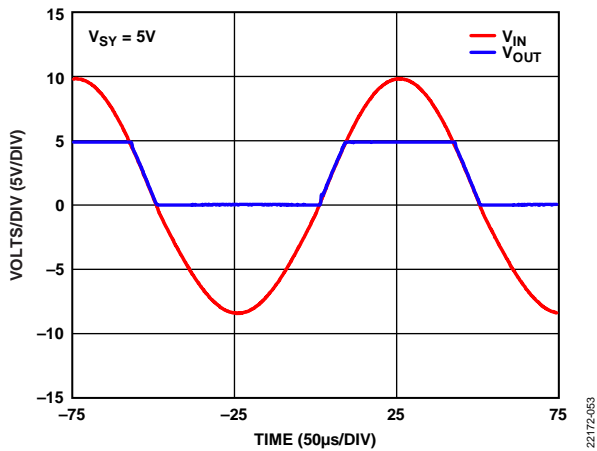

Figure 53. ADA4099-1 as Unity-Gain Buffer with Noninverting Input Driven Beyond the Supply ( $V_{SY} = 5$  V)

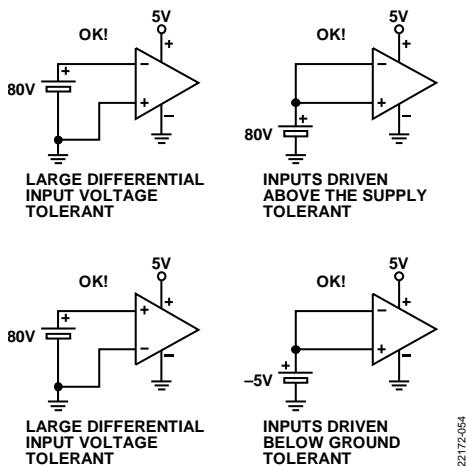

Figure 54. ADA4099-1 Fault Tolerant Conditions

**OVER-THE-TOP OPERATION CONSIDERATIONS**

When the ADA4099-1 input common-mode is biased near or  $>+V_S$  supply, the amplifier operates in the Over-The-Top configuration. The differential input pair that controls amplifier operation is the common base pair, Q3 to Q6 (see Figure 52).

Input bias currents change from  $<\pm 4$  nA in normal operation to approximately 82.5  $\mu$ A in Over-The-Top operation when the input stage transitions from common emitter to common base. The Over-The-Top input bias currents are well matched, and the associated offset is typically  $<250$  nA. Ensure that the impedance connected to the inverting and noninverting inputs is well matched to avoid any input bias current induced voltage offsets.

Differential input impedance,  $R_{IN}$  (see Figure 55), decreases from  $>100$  k $\Omega$  in normal operation to  $\sim 600$   $\Omega$  in Over-The-Top operation (see Table 1 and Table 2).

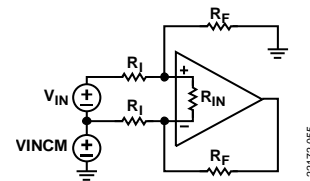

Figure 55. Difference Amplifier Configured for Normal Operation and Over-The-Top Operation

This  $R_{IN}$  resistance appears across the summing nodes in Over-The-Top operation due to the configuration of the common base input stage.

The  $R_{IN}$  value is derived from the specified  $I_B$  that flows to the op amp inputs, as expressed in the following equation:

$$R_{IN} = 2kT/(qI_B)$$

where:

$k$  is Boltzmann's constant.

$T$  is the operating temperature.

$q$  is the charge of an electron.

$I_B$  is the operating input bias current in Over-The-Top operation.

The inputs are biased proportional to absolute temperature. Therefore,  $R_{IN}$  is relatively constant with temperature. This resistance appears across the summing nodes of the amplifier, which is forced to 0 V differentially by the feedback action of the amplifier and can seem relatively harmless. However, depending on the configuration, this input resistance can boost the noise gain, lower overall amplifier loop gain and closed-loop bandwidth, and raise output noise. The singular benefit of this configuration is an increase in closed-loop amplifier stability.

In normal mode ( $-V_S < V_{CM} < +V_S - 1.5$  V),  $R_{IN}$  is typically large compared to the value of the gain setting resistors ( $R_F$  and  $R_i$ ), and  $R_{IN}$  can be ignored.

In this case, the noise gain is defined by the following equation:

$$Noise\ Gain = 1 + R_F/R_i$$

When the amplifier transitions to Over-The-Top operation with the input common-mode biased near or above the  $+V_S$  supply, consider the value of  $R_{IN}$ .

The noise gain of the amplifier increases as shown in the following equation:

$$\text{Noise Gain}_{OTT} = \left( \left( 1 + \frac{R_F}{R_I \parallel R_{IN} + R_I \parallel R_F} \right) \times \left( 1 + \frac{R_I \parallel R_F}{R_{IN}} \right) \right)$$

where  $\text{Noise Gain}_{OTT}$  is the Over-The-Top noise gain.

The dc closed-loop gain remains mostly unaffected ( $R_F/R_I$ ). However, the loop gain of the amplifier decreases, as expressed in the following equation:

$$\frac{A_{OL}}{1 + \frac{R_F}{R_I}} \text{ to } \frac{A_{OL}}{\text{Noise Gain}_{OTT}}$$

Likewise, the closed loop bandwidth ( $BW_{CLOSED\_LOOP}$ ) of the amplifier changes, going from normal operation to Over-The-Top operation.

In normal operation,

$$BW_{CLOSED\_LOOP} \approx \frac{GBP}{1 + \frac{R_F}{R_I}}$$

In Over-The-Top operation,

$$BW_{CLOSED\_LOOP} \approx \frac{GBP}{\text{Noise Gain}_{OTT}}$$

Output voltage noise density ( $e_{no}$ ) is impacted when the device transitions from normal operation to Over-The-Top operation. Resistor noise is neglected in both modes of operation in the following equations:

In normal operation, neglecting resistor noise,

$$e_{no} \cong e_n \left( 1 + \frac{R_F}{R_I} \right)$$

where  $e_n$  is input referred voltage noise density.

In Over-The-Top operation, neglecting resistor noise,

$$e_{no} \cong e_n \times \text{Noise Gain}_{OTT}$$

## OUTPUT

The output of the ADA4099-1 can swing rail-to-rail to within 45 mV of the either supply with no load. The output can source and sink  $\sim 30$  mA. The amplifier is internally compensated to drive at least 100 pF of load capacitance ( $C_L$ ). Adding a series resistance of 50  $\Omega$  between the output and larger capacitive loads extends the capacitive drive capability of the amplifier.

If the ADA4099-1 enters shutdown, the  $V_{OUT}$  pin appears as high impedance with two steering diodes connected to either supply. In this state, the output typically leaks  $< 5$  nA.

## SHUTDOWN PIN (SHDN)

The ADA4099-1 has a dedicated SHDN pin to place the amplifier in a very low power shutdown state when asserted high. A logic high is defined by a voltage  $\geq 1.5$  V applied to the SHDN pin with respect to the  $-V_S$  pin. In shutdown, the amplifier draws  $< 15$   $\mu$ A of supply current (see Figure 56) and the  $V_{OUT}$  pin is placed in a high impedance state.

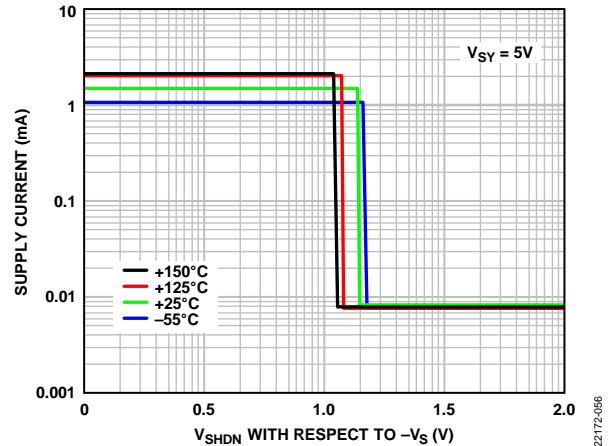

Figure 56. Supply Current vs.  $V_{SHDN}$  with Respect to  $-V_S$

The SHDN pin can be driven beyond the  $+V_S$  supply up to the absolute maximum voltage (60 V with respect to  $-V_S$ ) and draws little current ( $< 1.5$   $\mu$ A). For normal active amplifier operation, the SHDN pin can be floated or driven by an external voltage source low (within 0.5 V of  $-V_S$ ). If the SHDN pin is left floating, an internal current source ( $\sim 600$  nA) pulls the SHDN pin to  $-V_S$ , which places the amplifier into a default, active amplifying state. Because of the close proximity of the  $-IN$  pin and SHDN pin, fast edges on the  $-IN$  pin may ac-couple to the adjacent high impedance SHDN pin, inadvertently placing the device in shutdown. If this scenario is a concern, add a 1 nF capacitor between the SHDN pin and the  $-V_S$  pin.

Alternatively, the amplifier can be effectively placed in a low power state by removing  $+V_S$ . In this low power state, the inputs typically leak  $< 1$  nA with either  $\pm IN$  pin biased between  $-V_S$  and 70 V above  $-V_S$ . If the  $\pm IN$  pins are taken below  $-V_S$ , they appear as a diode connected to the  $-V_S$  supply in series with a resistance of 250  $\Omega$ . In this condition, limit the current to  $< 30$  mA.

Using an external source to drive the output beyond either  $\pm V_S$  supply under shutdown conditions may produce unlimited current and may damage the device.

## APPLICATIONS INFORMATION

### LARGE RESISTOR GAIN OPERATION

The ADA4099-1 has approximately 12 pF of input capacitance.

The parallel combination of the feedback resistor ( $R_F$ ) and gain setting resistor ( $R_G$ ) on the inverting input can combine with this input capacitance ( $C_{IN}$ ) to form a pole that can reduce bandwidth, cause frequency response peaking, or produce oscillations (see Figure 58). To mitigate these consequences, place a feedback capacitor with a value of  $C_F > C_{IN}(R_G/R_F)$  in parallel with  $R_F$  for summing node impedances  $>1\text{ k}\Omega$  ( $R_F || R_G > 1\text{ k}\Omega$ ). This capacitor placement cancels the input pole and optimizes dynamic performance (see Figure 57).

For applications where the noise gain is unity ( $R_G \rightarrow \infty$ ), and the feedback resistor exceeds 1 k $\Omega$ ,  $C_F \geq C_{IN}$ . Optimize PCB layouts to keep layout related summing node capacitance to an absolute minimum.

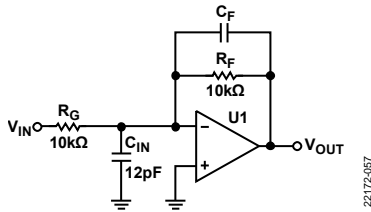

Figure 57. Inverting Gain Schematic

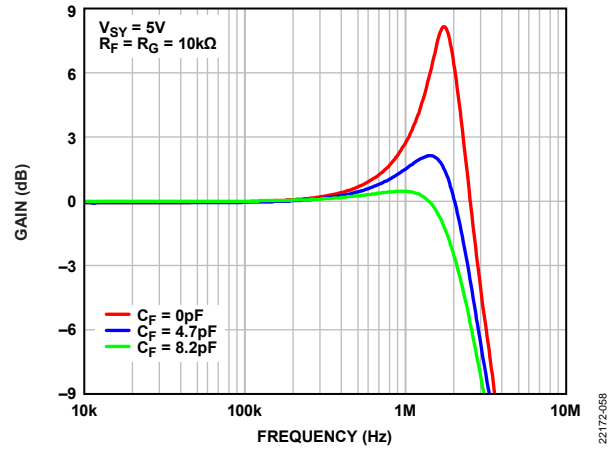

Figure 58. Inverting Gain of 1, Small Signal Frequency Response,  $R_F = R_G = 10\text{ k}\Omega$

### RECOMMENDED VALUES FOR VARIOUS GAINS

Table 7 is a reference for determining various recommended gains and associated noise performance. The total impedance seen at the inverting input is kept to  $<1\text{ k}\Omega$  for gains  $>1$  to maintain ideal small signal bandwidth.

Table 7. Gains and Associated Recommended Resistor Values ( $T_A = 25^\circ\text{C}$ )

Gain	$R_G$ (k $\Omega$ )	$R_F$ (k $\Omega$ )	$C_F$ (pF)	Approximate -3 dB Frequency (MHz)	Total System Noise (nV/ $\sqrt{\text{Hz}}$ at 1 kHz), Referred to Input
+1	Not applicable	0	Not applicable	8	6.8
+2	1	1	0	4	7.2
+2	10	10	8.2	2.7	11
+5	1	4.02	0	1.5	7.4
-1	10	10	8.2	2.1	22
-1	1	1	0	4.8	14.4
-2	1	2	0	2.9	11.3
-5	1	4.99	0	1.4	9.2
-10	1	10	0	0.75	8.7

**NOISE**

To analyze the noise performance of an amplifier circuit, identify the noise sources, and then determine if each source has a significant contribution to the overall noise performance of the amplifier. To simplify the noise calculations, noise spectral densities (NSDs) are used rather than actual voltages, to leave bandwidth out of the expressions. NSD is generally expressed in nV/√Hz and is equivalent to the noise in a 1 Hz bandwidth.

The noise model shown in Figure 59 has six individual noise sources: the Johnson noise of the three resistors (R1 to R3), the op amp voltage noise, and the current noise (IN±) in each input of the amplifier. Each noise source has its own contribution to the noise at the output. Noise is generally specified as referring to input (RTI), but it is often simpler to calculate the noise referred to the output (RTO), and then divide by the noise gain to obtain the RTI noise.

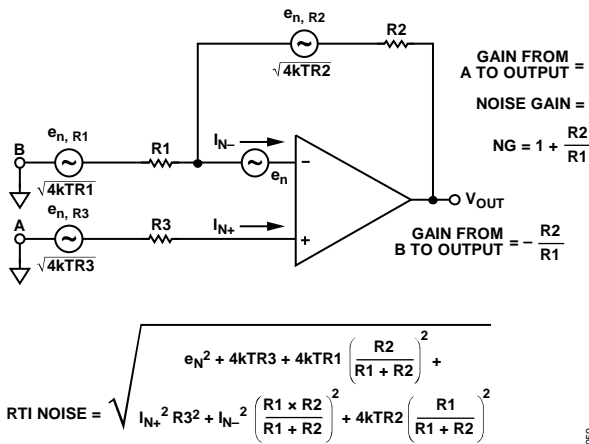

RTO NOISE = NG × RTI NOISE

Figure 59. Op Amp Noise Analysis Model

Assuming  $I_{N+} = I_{N-} = I_N$ , the equation for RTI noise can be simplified to the following form:

$$RTI\ Noise = \sqrt{e_n^2 + e_{n,R}^2 + (I_N R_{EQ})^2}$$

$$e_{n,R} = \sqrt{4kTR_{EQ}}$$

$$R_{EQ} = R_3 + R_1 || R_2$$

where:

$e_n$  is the op amp voltage noise.

$e_{n,R}$  is the thermal noise contribution of the surrounding R1 to R3 resistors.

$R_{EQ}$  is the equivalent input resistance.

$T$  is the absolute temperature in Kelvin.

A 50 Ω resistor generates a Johnson noise of 1 nV/√Hz at 25°C.

For optimal performance, the lower bound of resistance in a feedback network is determined by the amount of quiescent power and distortion that can be tolerated. The upper bound is determined by the resistor and current noise density. The ADA4099-1 has an  $e_n$  of 7 nV/√Hz.

If resistor and current noise contributions are less than half this value, the  $e_n$  introduced by the op amp dominates and provides optimal noise performance of the device.

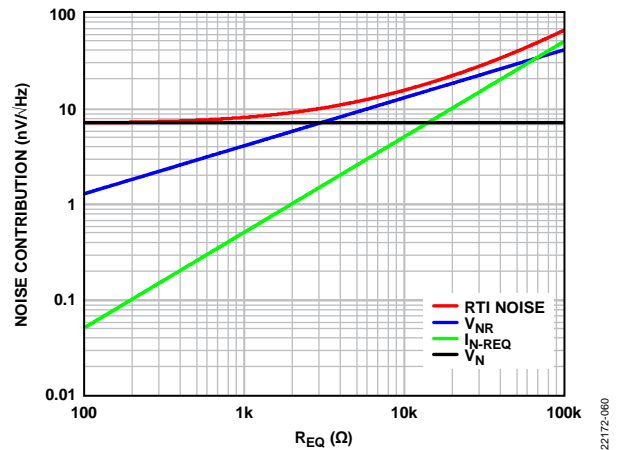

Figure 60. Noise Contributions vs. Equivalent Input Resistance (REQ)

For the ADA4099-1, this lower bound of resistance in the feedback network is about 750 Ω. For the amplifier configuration shown in Figure 59,  $R_{EQ} < 750 \Omega$  provides stable noise performance. If noise performance is not important,  $e_n$  is typically fixed for a given  $T_A$ ,  $e_{n,R}$  increases with the square root of the resistor value, and the  $I_N \times R_{EQ}$  resistance increases linearly, but does not impact total noise until it approaches the value of  $e_{n,R}$ . With  $R_{EQ} < \sim 60 \text{ k}\Omega$ ,  $e_{n,R}$  is larger than  $I_N \times R_{EQ}$ . A safe value for  $R_{EQ}$  is  $\sim 30 \text{ k}\Omega$  to ensure that  $I_N$  is not the majority contributor to total noise seen by the input.

Figure 60 shows the noise contributions for the range of resistance values discussed in this section.

**DISTORTION**

There are two main contributors of distortion in op amps: output crossover distortion as the output transitions from sourcing to sinking, and distortion caused by nonlinear common-mode rejection. If the op amp is operating in an inverting configuration, there is no common-mode induced distortion. If the op amp is operating in the noninverting configurations within the normal input common-mode range ( $-V_S$  to  $+V_S - 1.5 \text{ V}$ ), distortion is acceptable. When the inputs transition from normal to Over-The-Top operation or vice versa, a significant degradation occurs in linearity due to the change of input circuitry.

As  $R_L$  decreases, distortion increases due to a net decrease in loop gain and greater signal swings internal to the amplifier that are necessary to drive the load. The lowest distortion can be achieved with the ADA4099-1 operating in Class A operation in an inverting configuration, with the input common-mode biased at midsupply.

**POWER DISSIPATION AND THERMAL SHUTDOWN**

The ADA4099-1 can drive heavy loads on power supplies up to ±25 V. Therefore, ensure that  $T_J$  on the integrated circuit does not exceed 175°C. The ADA4099-1 is housed in a 6-lead TSOT package ( $\theta_{JA} = 192^\circ\text{C}/\text{W}$ ).

Junction temperatures exceeding 125°C promote accelerated aging. Reliability of the ADA4099-1 may be impaired if the junction temperature exceeds 175°C. If the junction temperature exceeds 175°C, the ADA4099-1 has a final safety measure in the form of a thermal shutdown that shuts off the output stage and reduces the internal device currents. When this thermal shutdown function triggers, the output remains disabled in a high impedance state until the junction temperature drops 20°C. Persistent heavy loads and elevated ambient temperatures can cause the ADA4099-1 to oscillate in and out of thermal shutdown depending on the power dissipated on the die, until the heavy load is removed (see Figure 61).

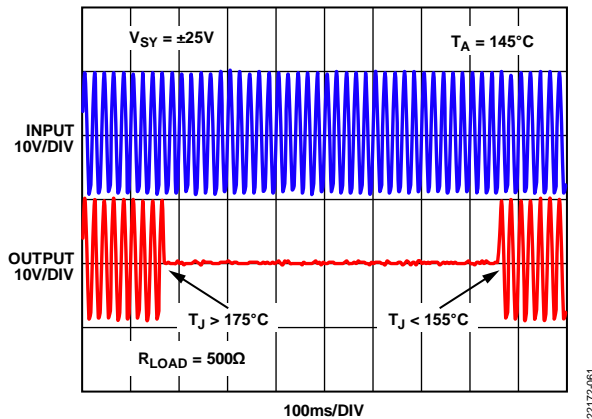

Figure 61. ADA4099-1 Cycling In and Out of Thermal Shutdown

It is not recommended to operate near the maximum junction temperature.

Typically,  $T_J$  can be estimated from  $T_A$  and the device power dissipation ( $P_D \times \theta_{JA}$ ), as shown in the following equation:

$$T_J = T_A + P_D \times \theta_{JA}$$

The power dissipation in the IC varies as a function of supply voltage, the output voltage, and load resistance. For a given supply voltage, the worst case power dissipation ( $P_{D(MAX)}$ ) in the IC occurs when the supply current is maximum, and the output voltage is at half of either supply voltage.

$$P_{D(MAX)} = V_s I_{s(MAX)} + \left( \frac{V_{SY}}{2} \right)^2 / R_L$$

For a given supply voltage, use Figure 62 as a guide for estimating the minimum load resistance that the ADA4099-1 can drive for a given supply voltage and a given rise in junction temperature ( $\Delta T_J$ ). For example, to limit  $\Delta T_J$  to 50°C, the load driven on the ±15 V supplies (+30 V total supply) must not be lower than 1.2 kΩ. It is assumed that  $\theta_{JA}$  is 192°C/W.

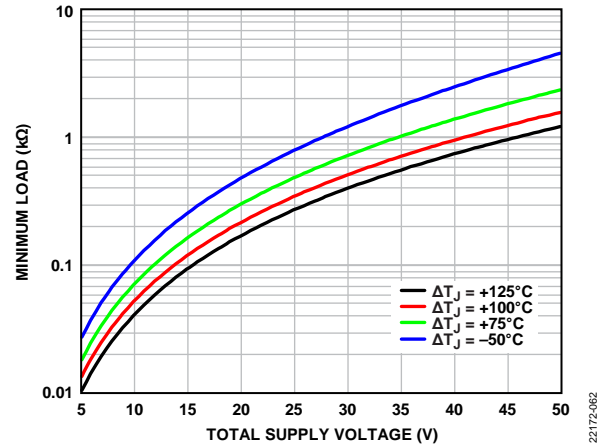

Figure 62. Minimum Load Resistance for Given  $\Delta T_J$  and  $V_{SY}$

**CIRCUIT LAYOUT CONSIDERATIONS**

Careful and deliberate attention to detail when laying out the ADA4099-1 boards yields optimal performance. Power supply bypassing, parasitic capacitance, and component selection all contribute to the overall performance of the amplifier.

**POWER SUPPLY BYPASSING**

On single supplies, solder the  $-V_s$  supply pin directly to a low impedance ground plane. Bypass the  $+V_s$  pin to a low impedance ground plane with a low effective series resistance (ESR) multilayer ceramic capacitor (MLCC) of 0.1 μF, typically, as close to the ± $V_s$  supply pins as possible. When driving heavy loads, add 10 μF of supply capacitance. When using split supplies, these conditions are applicable to the  $-V_s$  supply pin.

The ADA4099-1 has an internal current source of ~0.6 μA on the SHDN pin to pull the pin down to  $-V_s$  and to place the amplifier in the default amplifying state. If the SHDN state is not required, hard tie the SHDN pin to the  $-V_s$  pin. If the SHDN pin is left floating or driven by a source with significant source impedance (>100 Ω), bypass the  $-V_s$  supply pin with a small, 1 nF capacitor to prevent stray signals from coupling on the SHDN pin, which can inadvertently trigger shutdown.

**GROUNDING**

Use ground and power planes where possible to reduce the resistance and inductance of the supply and ground returns. Place bypass capacitors as close as possible to the ± $V_s$  supply pins, with the other ends connected to the ground plane. It is recommended to use a bypass capacitor of at least 0.1 μF when driving light loads (load currents < 100 μA), and more capacitance when driving heavier loads. Routing from the output to the load and return to the ground plane must have minimal loop area to keep inductance to a minimum.



**ESD PROTECTION WHEN POWERED**

ICs react to ESD strikes differently when unpowered vs. powered, which falls under IEC-61000-4-2 standards (see the Absolute Maximum Ratings section). A device that performs well under HBM conditions can perform poorly under International Electro-technical Commission (IEC) conditions. The ADA4099-1 is thoroughly abused with ESD strikes under IEC conditions to create a front-end circuit protection scheme that protects the device if subjected to ESD strikes. Figure 63 and Figure 64 show two different protection schemes that extend the protection of the ADA4099-1 to ±8 kV ESD strikes.

Consider the following when selecting components:

- A component size of 0805 or larger to reduce chance of arc-over.
- Pulse withstanding, thick film resistors.
- C0G MLCC with a minimum rating of 100 V.
- Bidirectional, transient voltage suppression (TVS) diodes.

In the circuit shown in Figure 63, R1 is a 220 Ω, Panasonic, 0805, ERJ-P6 series, and C1 is a 100 pF, Yageo, 0805, 100 V, C0G/NPO.

ADVANTAGES	DISADVANTAGES
INEXPENSIVE (~5 CENTS)	R1 INTRODUCES THERMAL NOISE
SMALL FOOTPRINT	RC NETWORK LIMITS SPEED
MINIMAL LEAKAGE	NEED TO CAREFULLY CHARACTERIZE CAPACITOR
	NOT AS ROBUST AGAINST REPEATED STRIKES

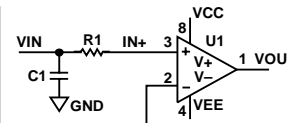

Figure 63. ESD Protection Circuit (RC Network)

In the circuit shown in Figure 64, R1 is a 220 Ω, Panasonic, 0805, ERJ-P6 series, and D1 is a Bourns CDSOD323-T36SC. An ESD varistor can be considered for D1.

For more information on system level ESD considerations, see the technical article, [When Good Electrons Go Bad: How to Protect Your Analog Front End](#), on the Analog Devices, Inc., website.

**RELATED PRODUCTS**

Table 8 describes several alternative precision amplifiers that can also be considered for certain applications.

ADVANTAGES	DISADVANTAGES
INEXPENSIVE (20 TO 30 CENTS)	R1 INTRODUCES NOISE
SMALL FOOTPRINT	D1 HAS LEAKAGE CURRENT
VERY ROBUST	D1 HAS CAPACITANCE (5pF TO 300pF)

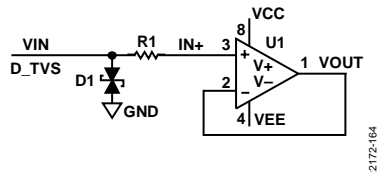

Figure 64. ESD Protection Circuit (R-TVS Network)

Table 8. ADA4099-1 Related Products

Model	V <sub>os</sub> (μV)	I <sub>B</sub> (nA)	GBP (kHz)	e <sub>n</sub> (nV/√Hz)	I <sub>SY</sub> (μA)	Input Common-Mode Range (V)
ADA4099-1	30	10	8000	7	1500	-V <sub>S</sub> to -V <sub>S</sub> + 70
<a href="#">ADA4077-1</a>	35	1	3900	7	500	-V <sub>S</sub> to +V <sub>S</sub>
<a href="#">LT6015</a>	50	5	3200	18	335	-V <sub>S</sub> to -V <sub>S</sub> + 76
<a href="#">LT6014</a>	60	0.4	1600	9.5	165	-V <sub>S</sub> to +V <sub>S</sub>
<a href="#">LT1494</a>	375	1	2.7	185	1.5	-V <sub>S</sub> to -V <sub>S</sub> + 36
<a href="#">LT1490A</a>	500	8	180	50	55	-V <sub>S</sub> to -V <sub>S</sub> + 44

TYPICAL APPLICATIONS

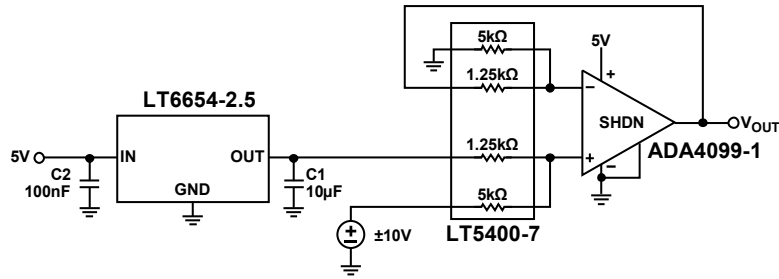

Figure 65.  $\pm 10\text{ V}$  to  $0\text{ V}$  to  $+5\text{ V}$  Funnel Amplifier, High CMRR and  $\pm 80\text{ V}$  Input Protection via **LT5400-7** Resistor Network

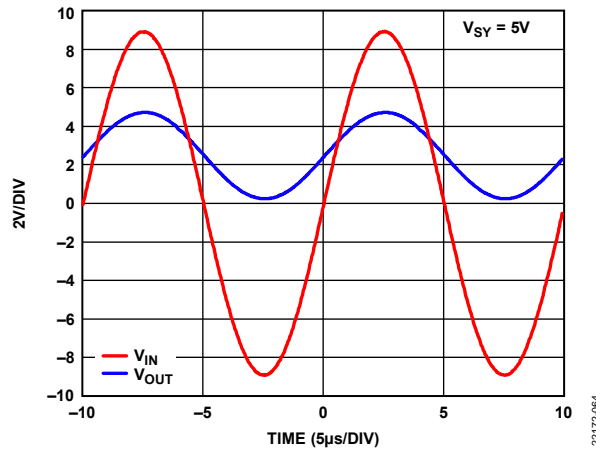

Figure 66.  $\pm 10\text{ V}$  to  $0\text{ V}$  to  $+5\text{ V}$  Funnel Amplifier, Input and Output Voltages

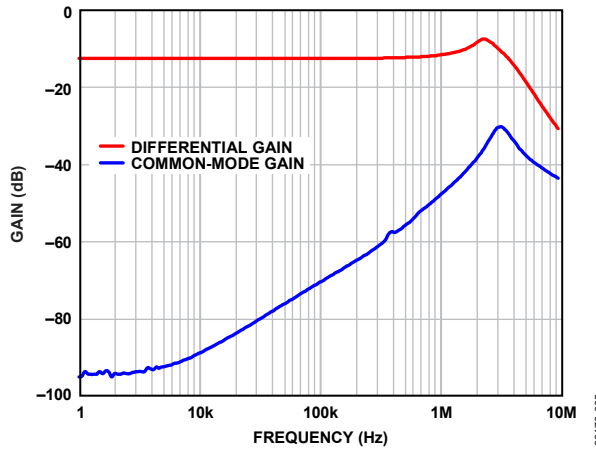

Figure 67.  $\pm 10\text{ V}$  to  $0\text{ V}$  to  $+5\text{ V}$  Funnel Amplifier, System Gain



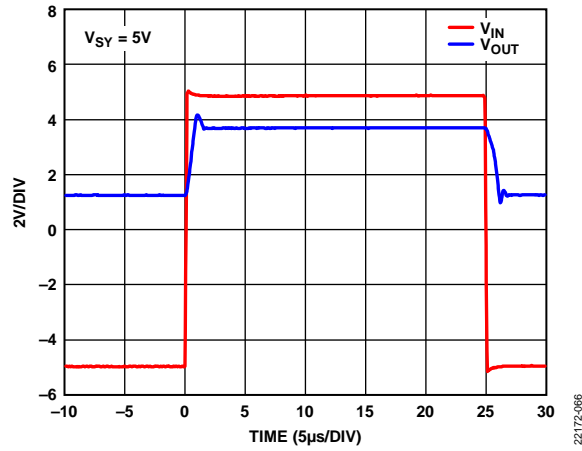

Figure 68.  $\pm 10\text{ V}$  to  $0\text{ V}$  to  $+5\text{ V}$  Funnel Amplifier, Large Signal Pulse Response

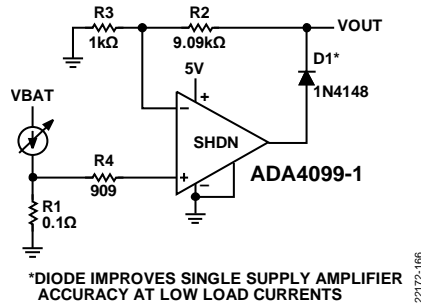

Figure 69. 1 V/A Low-Side Current Sense

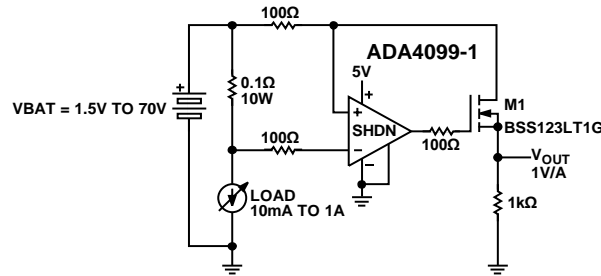

Figure 70. 1 V/A High-Side Current Sense

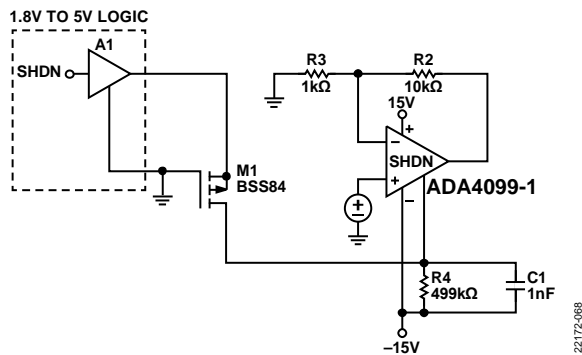

Figure 71. Microprocessor Control of SHDN Pin in Split Supply Applications

OUTLINE DIMENSIONS

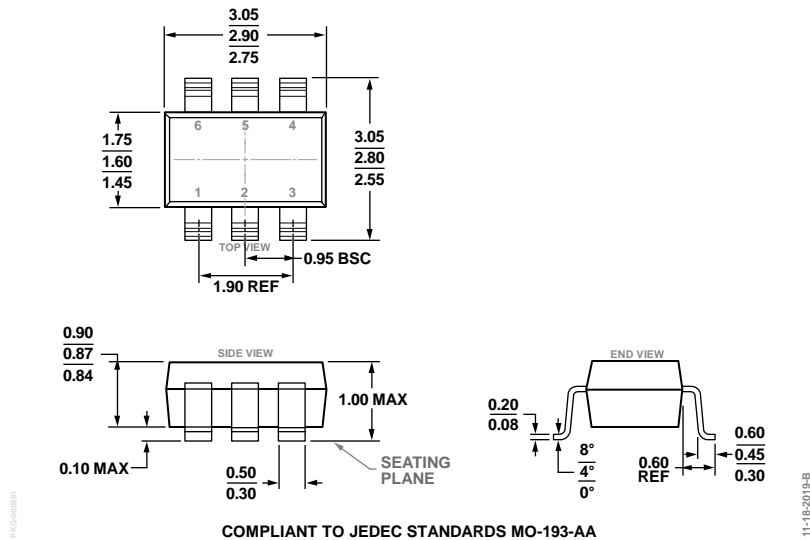

Figure 72. 6-Lead Small Outline Transistor Package [TSOT] (UJ-6)  
 Dimensions shown in millimeters

ORDERING GUIDE

Model <sup>1, 2</sup>	Temperature Range	Package Description	Package Option	Marking Code
ADA4099-1BUJZ-R5	-40°C to +125°C	6-Lead TSOT	UJ-6	Y7P
ADA4099-1BUJZ-RL7	-40°C to +125°C	6-Lead TSOT	UJ-6	Y7P
ADA4099-1HUJZ-RL7	-55°C to +150°C	6-Lead TSOT	UJ-6	Y7Q
EVAL-ADA4099-1HUJZ		Evaluation Board		

<sup>1</sup> Z = RoHS Compliant Part.

<sup>2</sup> Use a universal board, as referenced in the [UG-838](#) user guide, to evaluate the ADA4099-1.