

### FEATURES

- RF 2 × 2 transceiver with integrated 12-bit DACs and ADCs**
- Transmit band: 46.875 MHz to 6.0 GHz**
- Receive band: 70 MHz to 6.0 GHz**
- Dual receivers: 6 differential or 12 single-ended inputs**
- Superior receiver sensitivity with a NF of 2 dB at 800 MHz LO**
- Receive gain control**
  - Real-time monitor and control signals for manual gain
  - Independent AGC
- Dual transmitters: 4 differential outputs**
- Highly linear broadband transmitter**
  - Transmit EVM:  $-40$  dB (typical) at 800 MHz
  - Transmit noise:  $-157$  dBm/Hz (typical)
  - Transmit monitor: 66 dB dynamic range (typical) with 1 dB accuracy
- Integrated fractional-N synthesizers**
  - 2.4 Hz typical LO frequency step size
- Multichip synchronization**
- CMOS/LVDS digital interface**

### COMMERCIAL SPACE FEATURES

- Wafer diffusion lot traceability**
- Radiation lot acceptance testing: TID**

### APPLICATIONS

- Low Earth orbit (LEO) satellites**
- Avionics**
- Point to point communication systems**

### GENERAL DESCRIPTION

The AD9361S-CSL is a high performance, highly integrated, RF agile transceiver designed for use in 3G and 4G applications. Its programmability and wideband capability make it ideal for a broad range of transceiver applications. The device combines an RF front end with a flexible mixed-signal baseband section and integrated frequency synthesizers, simplifying design-in by providing a configurable digital interface to a processor. The AD9361S-CSL receiver LO operates from 70 MHz to 6.0 GHz and the transmitter LO operates from 46.875 MHz to 6.0 GHz range, covering most licensed and unlicensed bands. Channel bandwidths from less than 200 kHz to 56 MHz are supported.

The two independent direct conversion receivers have state-of-the-art noise figure and linearity. Each receive subsystem includes independent automatic gain control (AGC), dc offset correction, quadrature correction, and digital filtering, thereby eliminating the need for these functions in the digital baseband. The AD9361S-CSL also has flexible manual gain modes that can be externally controlled.

#### Rev. 0

#### Document Feedback

Information furnished by Analog Devices is believed to be accurate and reliable. However, no responsibility is assumed by Analog Devices for its use, nor for any infringements of patents or other rights of third parties that may result from its use. Specifications subject to change without notice. No license is granted by implication or otherwise under any patent or patent rights of Analog Devices. Trademarks and registered trademarks are the property of their respective owners.

### FUNCTIONAL BLOCK DIAGRAM

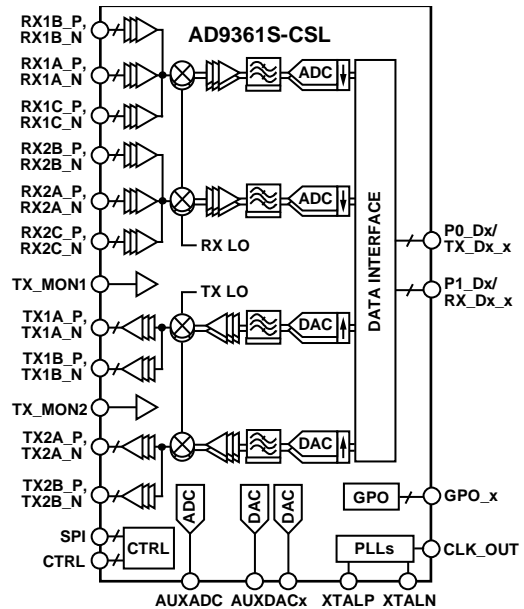

NOTES  
1. SPI, CTRL, P0\_Dx/TX\_Dx\_x, P1\_Dx/RX\_Dx\_x, AND GPO\_x CONTAIN MULTIPLE PINS.

23131-001

Figure 1.

Two high dynamic range analog-to-digital converters (ADCs) per channel digitize the received inphase (I) and quadrature (Q) signals and pass them through configurable decimation filters and 128-tap finite impulse response (FIR) filters to produce a 12-bit output signal at the appropriate sample rate.

The transmitters use a direct conversion architecture that achieves high modulation accuracy with ultralow noise. This transmitter design produces a best-in-class transmit error vector magnitude (EVM) of  $\leq -40$  dB, allowing significant system margin for the external power amplifier (PA) selection. The on-board transmit power monitor can be used as a power detector, enabling highly accurate transmit power measurements.

The fully integrated phase-locked loops (PLLs) provide low power fractional-N frequency synthesis for all receive and transmit channels. Channel isolation, demanded by frequency division duplex (FDD) systems, is integrated into the design. All voltage controlled oscillator (VCO) and loop filter components are integrated.

The AD9361S-CSL is packaged in a 10 mm × 10 mm, 144-ball chip scale package ball grid array (CSP\_BGA).

Additional application and technical information can be found in the [Commercial Space Products Program](#) brochure and the [AD9361](#) data sheet.

## TABLE OF CONTENTS

Features .....	1	Thermal Resistance .....	15
Commercial Space Features .....	1	ESD Caution.....	15
Applications.....	1	Pin Configuration and Function Descriptions.....	16
General Description .....	1	Typical Performance Characteristics .....	21
Functional Block Diagram .....	1	800 MHz Frequency Band .....	21
Revision History .....	2	2.4 GHz Frequency Band .....	26
Specifications.....	3	5.5 GHz Frequency Band .....	30
Current Consumption—VDD_Interface .....	9	Packaging and Ordering Information .....	33
Current Consumption—VDDD1P3_DIG and VDDAx (Combination of All 1.3 V Supplies) .....	10	Outline Dimensions.....	33
Radiation Test and Limit Specifications.....	14	Ordering Guide .....	33
Absolute Maximum Ratings .....	15		
Reflow Profile.....	15		

## REVISION HISTORY

12/2020—Revision 0: Initial Version

## SPECIFICATIONS

Electrical characteristics at VDD\_GPO = 3.3 V, VDD\_INTERFACE = 1.8 V, VDDD1P3\_DIG = 1.3 V, and all other VDDA1P3\_x pins = 1.3 V, T<sub>A</sub> = 25°C, unless otherwise noted. TX is transmit, and RX is receive. VDDA1P3\_x refers to VDDA1P3\_TX\_LO, VDDA1P3\_TX\_VCO\_LDO, VDDA1P3\_RX\_RF, VDDA1P3\_RX\_TX, VDDA1P3\_RX\_LO, VDDA1P3\_TX\_LO\_BUFFER, VDDA1P3\_RX\_VCO\_LDO, VDDA1P3\_RX\_SYNTH, VDDA1P3\_TX\_SYNTH, and VDDA1P3\_BB.

**Table 1.**

Parameter <sup>1</sup>	Symbol	Min	Typ	Max	Unit	Test Conditions/ Comments
RECEIVERS, GENERAL						
Center Frequency		70		6000	MHz	
Gain						
Minimum			0		dB	
Maximum			74.5		dB	At 800 MHz
			73.0		dB	At 2300 MHz (RX1A_x, RX2A_x)
			72.0		dB	At 2300 MHz (RX1B_x, RX1C_x, RX2B_x, RX2C_x)
			65.5		dB	At 5500 MHz (RX1A_x, RX2A_x)
Gain Step			1		dB	
Received Signal Strength Indicator	RSSI					
Range			100		dB	
Accuracy			±2		dB	
RECEIVERS, 800 MHz						
Noise Figure	NF		2		dB	Maximum RX gain
Third-Order Input Intermodulation Intercept Point	IIP3		-18		dBm	Maximum RX gain
Second-Order Input Intermodulation Intercept Point	IIP2		40		dBm	Maximum RX gain
Local Oscillator (LO) Leakage			-122		dBm	At RX front-end input
Quadrature						
Gain Error			0.2		%	
Phase Error			0.2		Degrees	
Modulation Accuracy (EVM)			-42		dB	19.2 MHz reference clock
Input Return Loss	S <sub>11</sub>		-10		dB	
Receiver Channel 1 (RX1) to Receiver Channel 2 (RX2) Isolation						
RX1A_x to RX2A_x, RX1C_x to RX2C_x			70		dB	
RX1B_x to RX2B_x			55		dB	
RX2 to RX1 Isolation						
RX2A_x to RX1A_x, RX2C_x to RX1C_x			70		dB	
RX2B_x to RX1B_x			55		dB	
RECEIVERS, 2.4 GHz						
Noise Figure	NF		3		dB	Maximum RX gain
Third-Order Input Intermodulation Intercept Point	IIP3		-14		dBm	Maximum RX gain
Second-Order Input Intermodulation Intercept Point	IIP2		45		dBm	Maximum RX gain
LO Leakage			-110		dBm	At receiver front-end input
Quadrature						
Gain Error			0.2		%	
Phase Error			0.2		Degrees	

Parameter <sup>1</sup>	Symbol	Min	Typ	Max	Unit	Test Conditions/ Comments	
Modulation Accuracy (EVM)	S <sub>11</sub>		-42		dB	40 MHz reference clock	
Input Return Loss			-10		dB		
RX1 to RX2 Isolation				65			dB
RX1A_x to RX2A_x, RX1C_x to RX2C_x				65			dB
RX1B_x to RX2B_x				50			dB
RX2 to RX1 Isolation				65			dB
RX2A_x to RX1A_x, RX2C_x to RX1C_x				65			dB
RX2B_x to RX1B_x			50		dB		
RECEIVERS, 5.5 GHz							
Noise Figure	NF		3.8		dB	Maximum RX gain	
Third-Order Input Intermodulation Intercept Point	IIP3		-17		dBm	Maximum RX gain	
Second-Order Input Intermodulation Intercept Point	IIP2		42		dBm	Maximum RX gain	
LO Leakage			-95		dBm	At RX front-end input	
Quadrature							
Gain Error			0.2		%		
Phase Error			0.2		Degrees		
Modulation Accuracy (EVM)			-37		dB	40 MHz reference clock (doubled internally for RF synthesizer)	
Input Return Loss	S <sub>11</sub>		-10		dB		
RX1A to RX2A Isolation			52		dB		
RX2A to RX1A Isolation			52		dB		
TRANSMITTERS—GENERAL							
Center Frequency		46.875		6000	MHz		
Power Control Range			90		dB		
Power Control Resolution			0.25		dB		
TRANSMITTERS, 800 MHz							
Output Return Loss	S <sub>22</sub>		-10		dB	1 MHz tone into 50 Ω load	
Maximum Output Power			8		dBm		
Modulation Accuracy (EVM)			-40		dB	19.2 MHz reference clock	
Third-Order Output Intermodulation Intercept Point	OIP3		23		dBm		
Carrier Leakage			-50		dBc	0 dB attenuation	
			-32		dBc	40 dB attenuation	
Noise Floor			-157		dBm/Hz	90 MHz offset	
Isolation							
Transmit Channel 1 (TX1) to Transmit Channel 2 (TX2)			50		dB		
TX2 to TX1			50		dB		
TRANSMITTERS, 2.4 GHz							
Output Return Loss	S <sub>22</sub>		-10		dB	1 MHz tone into 50 Ω load	
Maximum Output Power			7.5		dBm		
Modulation Accuracy (EVM)			-40		dB	40 MHz reference clock	
Third-Order Output Intermodulation Intercept Point	OIP3		19		dBm		
Carrier Leakage			-50		dBc	0 dB attenuation	
			-32		dBc	40 dB attenuation	
Noise Floor			-156		dBm/Hz	90 MHz offset	
Isolation							
TX1 to TX2			50		dB		
TX2 to TX1			50		dB		

Parameter <sup>1</sup>	Symbol	Min	Typ	Max	Unit	Test Conditions/ Comments
TRANSMITTERS, 5.5 GHz						
Output Return Loss	$S_{22}$		-10		dB	7 MHz tone into 50 $\Omega$ load
Maximum Output Power			6.5		dBm	
Modulation Accuracy (EVM)			-36		dB	40 MHz reference clock (doubled internally for RF synthesizer)
Third-Order Output Intermodulation Intercept Point	OIP3		17		dBm	0 dB attenuation 40 dB attenuation 90 MHz offset
Carrier Leakage			-50		dBc	
Noise Floor			-30		dBc	
Isolation			-151.5		dBm/Hz	
TX1 to TX2			50		dB	
TX2 to TX1			50		dB	
TX MONITOR INPUTS (TX_MON1, TX_MON2)						
Maximum Input Level			4		dBm	
Dynamic Range			66		dB	
Accuracy			1		dB	
LO SYNTHESIZER						
LO Frequency Step			2.4		Hz	2.4 GHz, 40 MHz reference clock
Integrated Phase Noise					$^{\circ}$ rms	
800 MHz			0.13			100 Hz to 100 MHz, 30.72 MHz reference clock (doubled internally for RF synthesizer)
2.4 GHz			0.37		$^{\circ}$ rms	100 Hz to 100 MHz, 40 MHz reference clock
5.5 GHz			0.59		$^{\circ}$ rms	100 Hz to 100 MHz, 40 MHz reference clock (doubled internally for RF synthesizer)
REFERENCE CLOCK						
Input						The reference clock is either the input to the XTALP/XTALN pins or a line directly to the XTALN pin
Frequency Range		19		50	MHz	Crystal input External oscillator
		10		80	MHz	
Signal Level			1.3		V p-p	AC-coupled external oscillator
AUXILIARY CONVERTERS						
ADC						
Resolution			12		Bits	
Input Voltage						
Minimum			0.05		V	
Maximum			VDDA1P3_BB - 0.05		V	
DAC						
Resolution			10		Bits	
Output Voltage						
Minimum			0.5		V	
Maximum			VDD_GPO - 0.3		V	
Output Current			10		mA	

Parameter <sup>1</sup>	Symbol	Min	Typ	Max	Unit	Test Conditions/ Comments
<b>DIGITAL SPECIFICATIONS (CMOS)</b>						
Logic Inputs						
Input Voltage						
High		$V_{DD\_INTERFACE} \times 0.8$		$V_{DD\_INTERFACE}$	V	
Low		0		$V_{DD\_INTERFACE} \times 0.2$	V	
Input Current						
High		-10		+10	μA	
Low		-10		+10	μA	
Logic Outputs						
Output Voltage						
High		$V_{DD\_INTERFACE} \times 0.8$			V	
Low				$V_{DD\_INTERFACE} \times 0.2$	V	
<b>DIGITAL SPECIFICATIONS (LOW VOLTAGE DIFFERENTIAL SIGNALING (LVDS))</b>						
Logic Inputs						
Input Voltage Range		825		1575	mV	Each differential input in the pair
Input Differential Voltage Threshold		-100		+100	mV	
Receiver Differential Input Impedance			100		Ω	
Logic Outputs						
Output Voltage						
High				1375	mV	Programmable in 75 mV steps
Low		1025			mV	
Output Differential Voltage		150			mV	
Output Offset Voltage			1200		mV	
<b>GENERAL-PURPOSE OUTPUTS</b>						
Output Voltage						
High		$V_{DD\_GPO} \times 0.8$			V	
Low				$V_{DD\_GPO} \times 0.2$	V	
Output Current			10		mA	
<b>SERIAL PERIPHERAL INTERFACE (SPI) TIMING</b>						
VDD_INTERFACE = 1.8 V						
SPI_CLK						
Period	t <sub>CP</sub>	20			ns	
Pulse Width	t <sub>MP</sub>	9			ns	
SPI_ENB Setup to First SPI_CLK Rising Edge	t <sub>SC</sub>	1			ns	
Last SPI_CLK Falling Edge to SPI_ENB Hold	t <sub>HC</sub>	0			ns	
SPI_DI						
Data Input Setup to SPI_CLK	t <sub>S</sub>	2			ns	
Data Input Hold to SPI_CLK	t <sub>H</sub>	1			ns	
SPI_CLK Rising Edge to Output Data Delay						
4-Wire Mode	t <sub>CO</sub>	3		8	ns	
3-Wire Mode	t <sub>CO</sub>	3		8	ns	

Parameter <sup>1</sup>	Symbol	Min	Typ	Max	Unit	Test Conditions/ Comments
Bus Turnaround Time, Read	t <sub>HZM</sub>	t <sub>H</sub>		t <sub>CO (max)</sub>	ns	After baseband processor (BBP) drives the last address bit
Bus Turnaround Time, Read	t <sub>HZS</sub>	0		t <sub>CO (max)</sub>	ns	After the AD9361S-CSL drives the last data bit
DIGITAL DATA TIMING (CMOS), VDD_INTERFACE = 1.8 V						
DATA_CLK_x Clock Period	t <sub>CP</sub>	16.276			ns	61.44 MHz
DATA_CLK_x and FB_CLK_x Pulse Width	t <sub>MP</sub>	45% of t <sub>CP</sub>		55% of t <sub>CP</sub>	ns	
TX Data						TX_FRAME_x, P0_Dx, and P1_Dx
Setup to FB_CLK_x	t <sub>STX</sub>	1			ns	
Hold to FB_CLK_x	t <sub>HTX</sub>	0			ns	
DATA_CLK_x to Data Bus Output Delay	t <sub>DDR<sub>X</sub></sub>	0		1.5	ns	
DATA_CLK_x to RX_FRAME_x Delay	t <sub>DDDV</sub>	0		1.0	ns	
Pulse Width						
ENABLE	t <sub>ENPW</sub>	t <sub>CP</sub>			ns	
TXNRX	t <sub>TXNRXPW</sub>	t <sub>CP</sub>			ns	FDD independent enable state machine (ESM) mode
TXNRX Setup to ENABLE	t <sub>TXNRXSU</sub>	0			ns	Time division duplex (TDD) ESM mode
Bus Turnaround Time						
Before RX	t <sub>RPRE</sub>	2 × t <sub>CP</sub>			ns	TDD mode
After RX	t <sub>RPST</sub>	2 × t <sub>CP</sub>			ns	TDD mode
Capacitive Load			3		pF	
Capacitive Input			3		pF	
DIGITAL DATA TIMING (CMOS), VDD_INTERFACE = 2.5 V						
DATA_CLK_x Clock Period	t <sub>CP</sub>	16.276			ns	61.44 MHz
DATA_CLK_x and FB_CLK_x Pulse Width	t <sub>MP</sub>	45% of t <sub>CP</sub>		55% of t <sub>CP</sub>	ns	
TX Data						TX_FRAME_x, P0_Dx, and P1_Dx
Setup to FB_CLK_x	t <sub>STX</sub>	1			ns	
Hold to FB_CLK_x	t <sub>HTX</sub>	0			ns	
DATA_CLK_x to Data Bus Output Delay	t <sub>DDR<sub>X</sub></sub>	0		1.2	ns	
DATA_CLK_x to RX_FRAME_x Delay	t <sub>DDDV</sub>	0		1.0	ns	
Pulse Width						
ENABLE	t <sub>ENPW</sub>	t <sub>CP</sub>			ns	
TXNRX	t <sub>TXNRXPW</sub>	t <sub>CP</sub>			ns	FDD independent ESM mode
TXNRX Setup to ENABLE	t <sub>TXNRXSU</sub>	0			ns	TDD ESM mode
Bus Turnaround Time						
Before RX	t <sub>RPRE</sub>	2 × t <sub>CP</sub>			ns	TDD mode
After RX	t <sub>RPST</sub>	2 × t <sub>CP</sub>			ns	TDD mode
Capacitive Load			3		pF	
Capacitive Input			3		pF	

Parameter <sup>1</sup>	Symbol	Min	Typ	Max	Unit	Test Conditions/ Comments
<b>DIGITAL DATA TIMING (LVDS)</b>						
DATA_CLK_x Clock Period	t <sub>CP</sub>	4.069			ns	245.76 MHz
DATA_CLK_x and FB_CLK_x Pulse Width	t <sub>MP</sub>	45% of t <sub>CP</sub>		55% of t <sub>CP</sub>	ns	
<b>TX Data</b>						
Setup to FB_CLK_x	t <sub>STX</sub>	1			ns	TX_FRAME_x and TX_Dx_x
Hold to FB_CLK_x	t <sub>HTX</sub>	0			ns	
DATA_CLK_x to Data Bus Output Delay	t <sub>DDRX</sub>	0.25		1.25	ns	
DATA_CLK_x to RX_FRAME_x Delay	t <sub>DDDV</sub>	0.25		1.25	ns	
Pulse Width						
ENABLE	t <sub>ENPW</sub>	t <sub>CP</sub>			ns	FDD independent ESM mode
TXNRX	t <sub>TXNRXPW</sub>	t <sub>CP</sub>			ns	
TXNRX Setup to ENABLE	t <sub>TXNRXSU</sub>	0			ns	TDD ESM mode
<b>Bus Turnaround Time</b>						
Before RX	t <sub>RPRE</sub>	2 × t <sub>CP</sub>			ns	
After RX	t <sub>RPST</sub>	2 × t <sub>CP</sub>			ns	
Capacitive Load			3		pF	
Capacitive Input			3		pF	
<b>SUPPLY CHARACTERISTICS</b>						
1.3 V Main Supply Voltage		1.267	1.3	1.33	V	
VDD_INTERFACE Supply						
Nominal Settings						
CMOS		1.14		2.625	V	
LVDS		1.71		2.625	V	
VDD_INTERFACE Tolerance		-5		+5	%	Tolerance is applicable to any voltage setting
VDD_GPO Supply Nominal Setting		1.3		3.3	V	When unused, must be set to 1.3 V
VDD_GPO Tolerance		-5		+5	%	Tolerance is applicable to any voltage setting
<b>Current Consumption</b>						
VDDA1P3_x, Sleep Mode			180		μA	Sum of all input currents
VDD_GPO			50		μA	No load

<sup>1</sup> When referencing a single function of a multifunction pin in the parameters, only the portion of the pin name that is relevant to the specification is listed. For full pin names of multifunction pins, refer to the Pin Configuration and Function Descriptions section.



**CURRENT CONSUMPTION—VDD\_INTERFACE**

TX is transmit, and RX is receive.

**Table 2. VDD\_INTERFACE = 1.2 V**

Parameter	Min	Typ	Max	Unit	Test Conditions/Comments
SLEEP MODE		45		μA	Power applied, device disabled
ONE RX CHANNEL, ONE TX CHANNEL, DOUBLE DATA RATE (DDR) Long-Term Evolution (LTE 10 MHz)					
Single Port		2.9		mA	30.72 MHz data clock, CMOS
Dual Port		2.7		mA	15.36 MHz data clock, CMOS
LTE 20 MHz					
Dual Port		5.2		mA	30.72 MHz data clock, CMOS
TWO RX CHANNELS, TWO TX CHANNELS, DDR					
LTE 3 MHz					
Dual Port		1.3		mA	7.68 MHz data clock, CMOS
LTE 10 MHz					
Single Port		4.6		mA	61.44 MHz data clock, CMOS
Dual Port		5.0		mA	30.72 MHz data clock, CMOS
LTE 20 MHz					
Dual Port		8.2		mA	61.44 MHz data clock, CMOS
Global System for Mobile Communications (GSM)					
Dual Port		0.2		mA	1.08 MHz data clock, CMOS

**Table 3. VDD\_INTERFACE = 1.8 V**

Parameter	Min	Typ	Max	Unit	Test Conditions/Comments
SLEEP MODE		84		μA	Power applied, device disabled
ONE RX CHANNEL, ONE TX CHANNEL, DDR					
LTE 10 MHz					
Single Port		4.5		mA	30.72 MHz data clock, CMOS
Dual Port		4.1		mA	15.36 MHz data clock, CMOS
LTE 20 MHz					
Dual Port		8.0		mA	30.72 MHz data clock, CMOS
TWO RX CHANNELS, TWO TX CHANNELS, DDR					
LTE 3 MHz					
Dual Port		2.0		mA	7.68 MHz data clock, CMOS
LTE 10 MHz					
Single Port		8.0		mA	61.44 MHz data clock, CMOS
Dual Port		7.5		mA	30.72 MHz data clock, CMOS
LTE 20 MHz					
Dual Port		14.0		mA	61.44 MHz data clock, CMOS
GSM					
Dual Port		0.3		mA	1.08 MHz data clock, CMOS

Table 4. VDD\_INTERFACE = 2.5 V

Parameter	Min	Typ	Max	Unit	Test Conditions/Comments
SLEEP MODE		150		μA	Power applied, device disabled
ONE RX CHANNEL, ONE TX CHANNEL, DDR					
LTE 10 MHz					
Single Port		6.5		mA	30.72 MHz data clock, CMOS
Dual Port		6.0		mA	15.36 MHz data clock, CMOS
LTE 20 MHz					
Dual Port		11.5		mA	30.72 MHz data clock, CMOS
TWO RX CHANNELS, TWO TX CHANNELS, DDR					
LTE 3 MHz					
Dual Port		3.0		mA	7.68 MHz data clock, CMOS
LTE 10 MHz					
Single Port		11.5		mA	61.44 MHz data clock, CMOS
Dual Port		10.0		mA	30.72 MHz data clock, CMOS
LTE 20 MHz					
Dual Port		20.0		mA	61.44 MHz data clock, CMOS
GSM					
Dual Port		0.5		mA	1.08 MHz data clock, CMOS

**CURRENT CONSUMPTION—VDD1P3\_DIG AND VDDA1P3\_x (COMBINATION OF ALL 1.3 V SUPPLIES)**

TX is transmit, and RX is receive.

Table 5. 800 MHz, TDD Mode

Parameter	Min	Typ	Max	Unit	Test Conditions/Comments
ONE RX CHANNEL					
5 MHz Bandwidth		180		mA	Continuous RX
10 MHz Bandwidth		210		mA	Continuous RX
20 MHz Bandwidth		260		mA	Continuous RX
TWO RX CHANNELS					
5 MHz Bandwidth		265		mA	Continuous RX
10 MHz Bandwidth		315		mA	Continuous RX
20 MHz Bandwidth		405		mA	Continuous RX
ONE TX CHANNEL					
5 MHz Bandwidth					
7 dBm		340		mA	Continuous TX
–27 dBm		190		mA	Continuous TX
10 MHz Bandwidth					
7 dBm		360		mA	Continuous TX
–27 dBm		220		mA	Continuous TX
20 MHz Bandwidth					
7 dBm		400		mA	Continuous TX
–27 dBm		250		mA	Continuous TX
TWO TX CHANNELS					
5 MHz Bandwidth					
7 dBm		550		mA	Continuous TX
–27 dBm		260		mA	Continuous TX
10 MHz Bandwidth					
7 dBm		600		mA	Continuous TX
–27 dBm		310		mA	Continuous TX
20 MHz Bandwidth					
7 dBm		660		mA	Continuous TX
–27 dBm		370		mA	Continuous TX

Table 6. TDD Mode, 2.4 GHz

Parameter	Min	Typ	Max	Unit	Test Conditions/Comments
ONE RX CHANNEL					
5 MHz Bandwidth		175		mA	Continuous receive
10 MHz Bandwidth		200		mA	Continuous RX
20 MHz Bandwidth		240		mA	Continuous RX
TWO RX CHANNELS					
5 MHz Bandwidth		260		mA	Continuous RX
10 MHz Bandwidth		305		mA	Continuous RX
20 MHz Bandwidth		390		mA	Continuous RX
ONE TX CHANNEL					
5 MHz Bandwidth					
7 dBm		350		mA	Continuous TX
-27 dBm		160		mA	Continuous TX
10 MHz Bandwidth					
7 dBm		380		mA	Continuous TX
-27 dBm		220		mA	Continuous TX
20 MHz Bandwidth					
7 dBm		410		mA	Continuous TX
-27 dBm		260		mA	Continuous TX
TWO TX CHANNELS					
5 MHz Bandwidth					
7 dBm		580		mA	Continuous TX
-27 dBm		280		mA	Continuous TX
10 MHz Bandwidth					
7 dBm		635		mA	Continuous TX
-27 dBm		330		mA	Continuous TX
20 MHz Bandwidth					
7 dBm		690		mA	Continuous TX
-27 dBm		390		mA	Continuous TX

Table 7. TDD Mode, 5.5 GHz

Parameter	Min	Typ	Max	Unit	Test Conditions/Comments
ONE RX CHANNEL					
5 MHz Bandwidth		175		mA	Continuous RX
40 MHz Bandwidth		275		mA	Continuous RX
TWO RX CHANNELS					
5 MHz Bandwidth		270		mA	Continuous RX
40 MHz Bandwidth		445		mA	Continuous RX
ONE TX CHANNEL					
5 MHz Bandwidth					
7 dBm		400		mA	Continuous TX
-27 dBm		240		mA	Continuous TX
40 MHz Bandwidth					
7 dBm		490		mA	Continuous TX
-27 dBm		385		mA	Continuous TX
TWO TX CHANNELS					
5 MHz Bandwidth					
7 dBm		650		mA	Continuous TX
-27 dBm		335		mA	Continuous TX
40 MHz Bandwidth					
7 dBm		820		mA	Continuous TX
-27 dBm		500		mA	Continuous TX

**Table 8. FDD Mode, 800 MHz**

<b>Parameter</b>	<b>Min</b>	<b>Typ</b>	<b>Max</b>	<b>Unit</b>
<b>ONE RX CHANNEL, ONE TX CHANNEL</b>				
5 MHz Bandwidth				
7 dBm		490		mA
-27 dBm		345		mA
10 MHz Bandwidth				
7 dBm		540		mA
-27 dBm		395		mA
20 MHz Bandwidth				
7 dBm		615		mA
-27 dBm		470		mA
<b>TWO RX CHANNELS, ONE TX CHANNEL</b>				
5 MHz Bandwidth				
7 dBm		555		mA
-27 dBm		410		mA
10 MHz Bandwidth				
7 dBm		625		mA
-27 dBm		480		mA
20 MHz Bandwidth				
7 dBm		740		mA
-27 dBm		600		mA
<b>ONE RX CHANNEL, TWO TX CHANNELS</b>				
5 MHz Bandwidth				
7 dBm		685		mA
-27 dBm		395		mA
10 MHz Bandwidth				
7 dBm		755		mA
-27 dBm		465		mA
20 MHz Bandwidth				
7 dBm		850		mA
-27 dBm		570		mA
<b>TWO RX CHANNELS, TWO TX CHANNELS</b>				
5 MHz Bandwidth				
7 dBm		790		mA
-27 dBm		495		mA
10 MHz Bandwidth				
7 dBm		885		mA
-27 dBm		590		mA
20 MHz Bandwidth				
7 dBm		1020		mA
-27 dBm		730		mA

Table 9. FDD Mode, 2.4 GHz

Parameter	Min	Typ	Max	Unit
ONE RX CHANNEL, ONE TX CHANNEL				
5 MHz Bandwidth				
7 dBm		500		mA
-27 dBm		350		mA
10 MHz Bandwidth				
7 dBm		540		mA
-27 dBm		390		mA
20 MHz Bandwidth				
7 dBm		620		mA
-27 dBm		475		mA
TWO RX CHANNELS, ONE TX CHANNEL				
5 MHz Bandwidth				
7 dBm		590		mA
-27 dBm		435		mA
10 MHz Bandwidth				
7 dBm		660		mA
-27 dBm		510		mA
20 MHz Bandwidth				
7 dBm		770		mA
-27 dBm		620		mA
ONE RX CHANNEL, TWO TX CHANNELS				mA
5 MHz Bandwidth				
7 dBm		730		mA
-27 dBm		425		mA
10 MHz Bandwidth				
7 dBm		800		mA
-27 dBm		500		mA
20 MHz Bandwidth				
7 dBm		900		mA
-27 dBm		600		mA
TWO RX CHANNELS, TWO TX CHANNELS				mA
5 MHz Bandwidth				
7 dBm		820		mA
-27 dBm		515		mA
10 MHz Bandwidth				
7 dBm		900		mA
-27 dBm		595		mA
20 MHz Bandwidth				
7 dBm		1050		mA
-27 dBm		740		mA

Table 10. FDD Mode, 5.5 GHz

Parameter	Min	Typ	Max	Unit
ONE RX CHANNEL, ONE TX CHANNEL				
5 MHz Bandwidth				
7 dBm		550		mA
-27 dBm		385		mA
TWO RX CHANNELS, ONE TX CHANNEL				
5 MHz Bandwidth				
7 dBm		645		mA
-27 dBm		480		mA

Parameter	Min	Typ	Max	Unit
ONE RX CHANNELS, TWO TX CHANNELS				
5 MHz Bandwidth				
7 dBm		805		mA
-27 dBm		480		mA
TWO RX CHANNELS, TWO TX CHANNELS				
5 MHz Bandwidth				
7 dBm		895		mA
-27 dBm		575		mA

## RADIATION TEST AND LIMIT SPECIFICATIONS

Electrical characteristics at VDD\_GPO = 3.3 V, VDD\_INTERFACE = 1.8 V, VDDD1P3\_DIG = 1.3 V, and all other VDDA1P3\_x pins = 1.3 V, T<sub>A</sub> = 25°C, unless otherwise noted. Total ionizing dose (TID) testing done to 30 krads with 50% overstress and biased annealing at 100°C for 168 hours.

Table 11.

Parameter	Test Conditions/Comments	Min	Typ	Max	Unit
SUPPLY CHARACTERISTICS					
Total Sleep Mode Current			2	14	mA
Total Active Mode Current			120	150	mA
DIGITAL INPUT CURRENTS					
Low		-0.1		+0.1	μA
High		-0.1		+0.1	μA
XTALN INPUT CURRENT	Reference clock input directly to the XTALN pin				
Low		-0.1		+0.1	μA
High		-200		+200	μA
RECEIVERS, 2.3 GHz					
LO Leakage	At receiver front-end input		-110	-75	dBm
RX1 to RX2 Isolation					
RX1A_x to RX2A_x, RX1C_x to RX2C_x		28	65		dB
RX1B_x to RX2B_x		28	50		dB
RX2 to RX1 Isolation					
RX2A_x to RX1A_x, RX2C_x to RX1C_x		28	65		dB
RX2B_x to RX1B_x		28	50		dB
TRANSMITTERS, 2.3 GHz					
Carrier Leakage	0 dB attenuation		-50	-42	dBc
	41.75 dB attenuation		-34	-25	dBc
Fundamental Output Power	0 dB attenuation	3.0	5.0		dBm

**ABSOLUTE MAXIMUM RATINGS**

Table 12.

Parameter	Rating
VDDD1P3_DIG, VDDA1P3_x <sup>1</sup> to VSSx	−0.3 V to +1.4 V
VDD_INTERFACE to VSSx	−0.3 V to +3.0 V
VDD_GPO to VSSx	−0.3 V to +3.9 V
Logic Inputs and Outputs to VSSx	−0.3 V to VDD_INTERFACE + 0.3 V
Input Current to Any Pin Except Supplies	±10 mA
RF Inputs (Peak Power)	2.5 dBm
TX Monitor Input Power (Peak Power)	9 dBm
Package Power Dissipation Maximum Junction Temperature (T <sub>JMAX</sub> )	(T <sub>JMAX</sub> − T <sub>A</sub> )/θ <sub>JA</sub> 110°C
Peak Reflow	260°C
Operating Temperature Range	−40°C to +85°C
Storage Temperature Range	−65°C to +150°C

<sup>1</sup> VDDA1P3\_x refers to VDDA1P3\_TX\_LO, VDDA1P3\_TX\_VCO\_LDO, VDDA1P3\_RX\_RF, VDDA1P3\_RX\_TX, VDDA1P3\_RX\_LO, VDDA1P3\_TX\_LO\_BUFFER, VDDA1P3\_RX\_VCO\_LDO, VDDA1P3\_RX\_SYNTH, VDDA1P3\_TX\_SYNTH, and VDDA1P3\_BB.

Stresses at or above those listed under Absolute Maximum Ratings may cause permanent damage to the product. This is a stress rating only; functional operation of the product at these or any other conditions above those indicated in the operational section of this specification is not implied. Operation beyond the maximum operating conditions for extended periods may affect product reliability.

**REFLOW PROFILE**

The AD9361S-CSL reflow profile is in accordance with the JEDEC JESD20 criteria for Pb-free devices. The maximum reflow temperature is 260°C.

**THERMAL RESISTANCE**

Thermal performance is directly linked to printed circuit board (PCB) design and operating environment. Careful attention to PCB thermal design is required.

θ<sub>JA</sub> is the natural convection junction to ambient thermal resistance measured in a one cubic foot sealed enclosure.

θ<sub>JCT</sub> is the junction to case top thermal resistance.

Table 13. Thermal Resistance

Package Type	Airflow Velocity (m/sec)	θ <sub>JA</sub> <sup>1,2</sup>	θ <sub>JCT</sub> <sup>1,3</sup>	Unit
BC-144-7	0	32.3	9.6	°C/W
	1.0	29.6		°C/W
	2.5	27.8		°C/W

<sup>1</sup> Per JEDEC JESD51-7, plus JEDEC JESD51-5 2S2P test board.

<sup>2</sup> Per JEDEC JESD51-2 (still air) or JEDEC JESD51-6 (moving air).

<sup>3</sup> Per MIL-STD 883, Method 1012.1.

**ESD CAUTION****ESD (electrostatic discharge) sensitive device.**

Charged devices and circuit boards can discharge without detection. Although this product features patented or proprietary protection circuitry, damage may occur on devices subjected to high energy ESD. Therefore, proper ESD precautions should be taken to avoid performance degradation or loss of functionality.

### PIN CONFIGURATION AND FUNCTION DESCRIPTIONS

	1	2	3	4	5	6	7	8	9	10	11	12
A	RX2A_N	RX2A_P	DNC	VSSA	TX_MON2	VSSA	TX2A_N	TX2A_P	TX2B_N	TX2B_P	VDDA1P1_TX_VCO	TX_EXT_LO_IN
B	VSSA	VSSA	AUXDAC1	GPO_3	GPO_2	GPO_1	GPO_0	VDD_GPO	VDDA1P3_TX_LO	VDDA1P3_TX_VCO_LDO	TX_VCO_LDO_OUT	VSSA
C	RX2C_P	VSSA	AUXDAC2	TEST/ENABLE	CTRL_IN0	CTRL_IN1	VSSA	VSSA	VSSA	VSSA	VSSA	VSSA
D	RX2C_N	VDDA1P3_RX_RF	VDDA1P3_RX_TX	CTRL_OUT0	CTRL_IN3	CTRL_IN2	P0_D9/TX_D4_P	P0_D7/TX_D3_P	P0_D5/TX_D2_P	P0_D3/TX_D1_P	P0_D1/TX_D0_P	VSSD
E	RX2B_P	VDDA1P3_RX_LO	VDDA1P3_TX_LO_BUFFER	CTRL_OUT1	CTRL_OUT2	CTRL_OUT3	P0_D11/TX_D5_P	P0_D8/TX_D4_N	P0_D6/TX_D3_N	P0_D4/TX_D2_N	P0_D2/TX_D1_N	P0_D0/TX_D0_N
F	RX2B_N	VDDA1P3_RX_VCO_LDO	VSSA	CTRL_OUT6	CTRL_OUT5	CTRL_OUT4	VSSD	P0_D10/TX_D5_N	VSSD	FB_CLK_P	VSSD	VDDD1P3_DIG
G	RX_EXT_LO_IN	RX_VCO_LDO_OUT	VDDA1P1_RX_VCO	CTRL_OUT7	EN_AGC	ENABLE	RX_FRAME_N	RX_FRAME_P	TX_FRAME_P	FB_CLK_N	DATA_CLK_P	VSSD
H	RX1B_P	VSSA	VSSA	TXNRX	SYNC_IN	VSSA	VSSD	P1_D11/RX_D5_P	TX_FRAME_N	VSSD	DATA_CLK_N	VDD_INTERFACE
J	RX1B_N	VSSA	VDDA1P3_RX_SYNTH	SPI_DI	SPI_CLK	CLK_OUT	P1_D10/RX_D5_N	P1_D9/RX_D4_P	P1_D7/RX_D3_P	P1_D5/RX_D2_P	P1_D3/RX_D1_P	P1_D1/RX_D0_P
K	RX1C_P	VSSA	VDDA1P3_TX_SYNTH	VDDA1P3_BB	RESETB	SPI_ENB	P1_D8/RX_D4_N	P1_D6/RX_D3_N	P1_D4/RX_D2_N	P1_D2/RX_D1_N	P1_D0/RX_D0_N	VSSD
L	RX1C_N	VSSA	VSSA	RBIAS	AUXADC	SPI_DO	VSSA	VSSA	VSSA	VSSA	VSSA	VSSA
M	RX1A_P	RX1A_N	DNC	VSSA	TX_MON1	VSSA	TX1A_P	TX1A_N	TX1B_P	TX1B_N	XTALP	XTALN

ANALOG I/O   
  DC POWER  
 DIGITAL I/O   
  GROUND  
 DO NOT CONNECT

Figure 2. Pin Configuration, Top View

Table 14. Pin Function Descriptions

Pin No.	Type <sup>1</sup>	Mnemonic	Description
A1, A2	I	RX2A_N, RX2A_P	Receive Channel 2 Differential Input A. Each pin can be used as a single-ended input or combined to make a differential pair. Tie unused pins to ground.
A3, M3	DNC	DNC	Do Not Connect. Do not connect to these pins.
A4, A6, B1, B2, B12, C2, C7 to C12, F3, H2, H3, H6, J2, K2, L2, L3, L7 to L12, M4, M6	I	VSSA	Analog Ground. Tie these pins directly to the VSSD digital ground on the PCB (one ground plane).
A5	I	TX_MON2	Transmit Channel 2 Power Monitor Input. If this pin is unused, tie it to ground.
A7, A8	O	TX2A_N, TX2A_P	Transmit Channel 2 Differential Output A. Tie unused pins to 1.3 V.
A9, A10	O	TX2B_N, TX2B_P	Transmit Channel 2 Differential Output B. Tie unused pins to 1.3 V.
A11	I	VDDA1P1_TX_VCO	Transmit VCO Supply Input. Connect to B11.
A12	I	TX_EXT_LO_IN	External Transmit LO Input. If this pin is unused, tie it to ground.
B3	O	AUXDAC1	Auxiliary DAC 1 Output.
B4 to B7	O	GPO_3 to GPO_0	3.3 V Capable General-Purpose Outputs.
B8	I	VDD_GPO	2.5 V to 3.3 V Supply for the AUXDACx and General-Purpose Output Pins. When the VDD_GPO supply is not used, this supply must be set to 1.3 V.
B9	I	VDDA1P3_TX_LO	Transmit LO 1.3 V Supply Input. Connect to B10.
B10	I	VDDA1P3_TX_VCO_LDO	Transmit VCO LDO 1.3 V Supply Input. Connect to B9.
B11	O	TX_VCO_LDO_OUT	Transmit VCO LDO Output. Connect to A11 and a 1 μF bypass capacitor in series with a 1 Ω resistor to ground.



Pin No.	Type <sup>1</sup>	Mnemonic	Description
C1, D1	I	RX2C_P, RX2C_N	Receive Channel 2 Differential Input C. Each pin can be used as a single-ended input or combined to make a differential pair. These inputs experience degraded performance above 3 GHz. Tie unused pins to ground.
C3	O	AUXDAC2	Auxiliary DAC 2 Output.
C4	I	TEST/ENABLE	Test Input. Ground this pin for normal operation.
C5, C6, D6, D5	I	CTRL_IN0 to CTRL_IN3	Control Inputs. Use these pins for manual RX gain and TX attenuation control.
D2	I	VDDA1P3_RX_RF	Receiver 1.3 V Supply Input. Connect to D3.
D3	I	VDDA1P3_RX_TX	1.3 V Supply Input. Connect to D2.
D4, E4 to E6, F4 to F6, G4	O	CTRL_OUT0, CTRL_OUT1 to CTRL_OUT3, CTRL_OUT6 to CTRL_OUT4, CTRL_OUT7	Control Outputs. These pins are multipurpose outputs that have programmable functionality.
D7	I/O	P0_D9/TX_D4_P	Digital Data Port P0/Transmit Differential Input Bus. This is a dual function pin. As P0_D9, it functions as part of the 12-bit bidirectional parallel CMOS level Data Port 0. Alternatively, as TX_D4_P, this pin can function as part of the LVDS 6-bit TX differential input bus with internal LVDS termination.
D8	I/O	P0_D7/TX_D3_P	Digital Data Port P0/Transmit Differential Input Bus. This is a dual function pin. As P0_D7, it functions as part of the 12-bit bidirectional parallel CMOS level Data Port 0. Alternatively, as TX_D3_P, this pin can function as part of the LVDS 6-bit TX differential input bus with internal LVDS termination.
D9	I/O	P0_D5/TX_D2_P	Digital Data Port P0/Transmit Differential Input Bus. This is a dual function pin. As P0_D5, it functions as part of the 12-bit bidirectional parallel CMOS level Data Port 0. Alternatively, as TX_D2_P, this pin can function as part of the LVDS 6-bit TX differential input bus with internal LVDS termination.
D10	I/O	P0_D3/TX_D1_P	Digital Data Port P0/Transmit Differential Input Bus. This is a dual function pin. As P0_D3, it functions as part of the 12-bit bidirectional parallel CMOS level Data Port 0. Alternatively, as TX_D1_P, this pin can function as part of the LVDS 6-bit TX differential input bus with internal LVDS termination.
D11	I/O	P0_D1/TX_D0_P	Digital Data Port P0/Transmit Differential Input Bus. This is a dual function pin. As P0_D1, it functions as part of the 12-bit bidirectional parallel CMOS level Data Port 0. Alternatively, as TX_D0_P, this pin can function as part of the LVDS 6-bit TX differential input bus with internal LVDS termination.
D12, F7, F9, F11, G12, H7, H10, K12	I	VSSD	Digital Ground. Tie these pins directly to the VSSA analog ground on the PCB (one ground plane).
E1, F1	I	RX2B_P, RX2B_N	Receive Channel 2 Differential Input B. Each pin can be used as a single-ended input or combined to make a differential pair. These inputs experience degraded performance above 3 GHz. Tie unused pins to ground.
E2	I	VDDA1P3_RX_LO	Receive LO 1.3 V Supply Input. Connect to F2.
E3	I	VDDA1P3_TX_LO_BUFFER	Transmit LO Buffer. 1.3 V Supply Input.
E7	I/O	P0_D11/TX_D5_P	Digital Data Port P0/Transmit Differential Input Bus. This is a dual function pin. As P0_D11, it functions as part of the 12-bit bidirectional parallel CMOS level Data Port 0. Alternatively, as TX_D5_P, this pin can function as part of the LVDS 6-bit TX differential input bus with internal LVDS termination.
E8	I/O	P0_D8/TX_D4_N	Digital Data Port P0/Transmit Differential Input Bus. This is a dual function pin. As P0_D8, it functions as part of the 12-bit bidirectional parallel CMOS level Data Port 0. Alternatively, as TX_D4_N, this pin can function as part of the LVDS 6-bit TX differential input bus with internal LVDS termination.

Pin No.	Type <sup>1</sup>	Mnemonic	Description
E9	I/O	P0_D6/TX_D3_N	Digital Data Port P0/Transmit Differential Input Bus. This is a dual function pin. As P0_D6, it functions as part of the 12-bit bidirectional parallel CMOS level Data Port 0. Alternatively, as TX_D3_N, this pin can function as part of the LVDS 6-bit TX differential input bus with internal LVDS termination.
E10	I/O	P0_D4/TX_D2_N	Digital Data Port P0/Transmit Differential Input Bus. This is a dual function pin. As P0_D4, it functions as part of the 12-bit bidirectional parallel CMOS level Data Port 0. Alternatively, as TX_D2_N, this pin can function as part of the LVDS 6-bit TX differential input bus with internal LVDS termination.
E11	I/O	P0_D2/TX_D1_N	Digital Data Port P0/Transmit Differential Input Bus. This is a dual function pin. As P0_D2, it functions as part of the 12-bit bidirectional parallel CMOS level Data Port 0. Alternatively, as TX_D1_N, this pin can function as part of the LVDS 6-bit TX differential input bus with internal LVDS termination.
E12	I/O	P0_D0/TX_D0_N	Digital Data Port P0/Transmit Differential Input Bus. This is a dual function pin. As P0_D0, it functions as part of the 12-bit bidirectional parallel CMOS level Data Port 0. Alternatively, as TX_D0_N, this pin can function as part of the LVDS 6-bit TX differential input bus with internal LVDS termination.
F2	I	VDDA1P3_RX_VCO_LDO	Receive VCO LDO 1.3 V Supply Input. Connect to E2.
F8	I/O	P0_D10/TX_D5_N	Digital Data Port P0/Transmit Differential Input Bus. This is a dual function pin. As P0_D10, it functions as part of the 12-bit bidirectional parallel CMOS level Data Port 0. Alternatively, as TX_D5_N, this pin can function as part of the LVDS 6-bit TX differential input bus with internal LVDS termination.
F10, G10	I	FB_CLK_P, FB_CLK_N	Feedback Clock. These pins receive the FB_CLK_x signal that clocks in TX data. In CMOS mode, use FB_CLK_P as the input and tie FB_CLK_N to ground.
F12	I	VDDD1P3_DIG	1.3 V Digital Supply Input.
G1	I	RX_EXT_LO_IN	External Receive LO Input. If this pin is unused, tie it to ground.
G2	O	RX_VCO_LDO_OUT	Receive VCO LDO Output. Connect this pin directly to G3 and a 1 $\mu$ F bypass capacitor in series with a 1 $\Omega$ resistor to ground.
G3	I	VDDA1P1_RX_VCO	Receive VCO Supply Input. Connect this pin directly to G2 only.
G5	I	EN_AGC	Manual Control Input for AGC.
G6	I	ENABLE	Control Input. This pin moves the device through various operational states.
G7, G8	O	RX_FRAME_N, RX_FRAME_P	Receive Digital Data Framing Output Signal. These pins transmit the RX_FRAME_x signal that indicates whether the RX output data is valid. In CMOS mode, use RX_FRAME_P as the output and leave RX_FRAME_N unconnected.
G9, H9	I	TX_FRAME_P, TX_FRAME_N	Transmit Digital Data Framing Input Signal. These pins receive the TX_FRAME_x signal that indicates when TX data is valid. In CMOS mode, use TX_FRAME_P as the input and tie TX_FRAME_N to ground.
G11, H11	O	DATA_CLK_P, DATA_CLK_N	Receive Data Clock Output. These pins transmit the DATA_CLK_x signal that is used by the BBP to clock RX data. In CMOS mode, use DATA_CLK_P as the output and leave DATA_CLK_N unconnected.
H1, J1	I	RX1B_P, RX1B_N	Receive Channel 1 Differential Input B. Alternatively, each pin can be used as a single-ended input. These inputs experience degraded performance above 3 GHz. Tie unused pins to ground.
H4	I	TXNRX	Enable State Machine Control Signal. This pin controls the data port bus direction. A logic low selects the RX direction, and a logic high selects the TX direction.
H5	I	SYNC_IN	Input to Synchronize Digital Clocks Between Multiple AD9361S-CSL Devices. If this pin is unused, tie it to ground.
H8	I/O	P1_D11/RX_D5_P	Digital Data Port P1/Receive Differential Output Bus. This is a dual function pin. As P1_D11, it functions as part of the 12-bit bidirectional parallel CMOS level Data Port 1. Alternatively, as RX_D5_P, this pin can function as part of the LVDS 6-bit RX differential output bus with internal LVDS termination.

Pin No.	Type <sup>1</sup>	Mnemonic	Description
H12	I	VDD_INTERFACE	1.2 V to 2.5 V Supply for Digital I/O Pins (1.8 V to 2.5 V in LVDS Mode).
J3	I	VDDA1P3_RX_SYNTN	1.3 V Supply Input.
J4	I	SPI_DI	SPI Serial Data Input.
J5	I	SPI_CLK	SPI Clock Input.
J6	O	CLK_OUT	Output Clock. This pin can be configured to output either a buffered version of the external input clock, the digitally controlled crystal oscillator (DCXO), or a divided down version of the internal ADC clock.
J7	I/O	P1_D10/RX_D5_N	Digital Data Port P1/Receive Differential Output Bus. This is a dual function pin. As P1_D10, it functions as part of the 12-bit bidirectional parallel CMOS level Data Port 1. Alternatively, as RX_D5_N, this pin can function as part of the LVDS 6-bit RX differential output bus with internal LVDS termination.
J8	I/O	P1_D9/RX_D4_P	Digital Data Port P1/Receive Differential Output Bus. This is a dual function pin. As P1_D9, it functions as part of the 12-bit bidirectional parallel CMOS level Data Port 1. Alternatively, as RX_D4_P, this pin can function as part of the LVDS 6-bit RX differential output bus with internal LVDS termination.
J9	I/O	P1_D7/RX_D3_P	Digital Data Port P1/Receive Differential Output Bus. This is a dual function pin. As P1_D7, it functions as part of the 12-bit bidirectional parallel CMOS level Data Port 1. Alternatively, as RX_D3_P, this pin can function as part of the LVDS 6-bit RX differential output bus with internal LVDS termination.
J10	I/O	P1_D5/RX_D2_P	Digital Data Port P1/Receive Differential Output Bus. This is a dual function pin. As P1_D5, it functions as part of the 12-bit bidirectional parallel CMOS level Data Port 1. Alternatively, as RX_D2_P, this pin can function as part of the LVDS 6-bit RX differential output bus with internal LVDS termination.
J11	I/O	P1_D3/RX_D1_P	Digital Data Port P1/Receive Differential Output Bus. This is a dual function pin. As P1_D3, it functions as part of the 12-bit bidirectional parallel CMOS level Data Port 1. Alternatively, as RX_D1_P, this pin can function as part of the LVDS 6-bit RX differential output bus with internal LVDS termination.
J12	I/O	P1_D1/RX_D0_P	Digital Data Port P1/Receive Differential Output Bus. This is a dual function pin. As P1_D1, it functions as part of the 12-bit bidirectional parallel CMOS level Data Port 1. Alternatively, as RX_D0_P, this pin can function as part of the LVDS 6-bit RX differential output bus with internal LVDS termination.
K1, L1	I	RX1C_P, RX1C_N	Receive Channel 1 Differential Input C. Alternatively, each pin can be used as a single-ended input. These inputs experience degraded performance above 3 GHz. Tie unused pins to ground.
K3	I	VDDA1P3_TX_SYNTN	1.3 V Supply Input.
K4	I	VDDA1P3_BB	1.3 V Supply Input.
K5	I	RESETB	Asynchronous Reset. Logic low resets the device.
K6	I	SPI_ENB	SPI Enable Input. Set this pin to logic low to enable the SPI bus.
K7	I/O	P1_D8/RX_D4_N	Digital Data Port P1/Receive Differential Output Bus. This is a dual function pin. As P1_D8, it functions as part of the 12-bit bidirectional parallel CMOS level Data Port 1. Alternatively, as RX_D4_N, this pin can function as part of the LVDS 6-bit RX differential output bus with internal LVDS termination.
K8	I/O	P1_D6/RX_D3_N	Digital Data Port P1/Receive Differential Output Bus. This is a dual function pin. As P1_D6, it functions as part of the 12-bit bidirectional parallel CMOS level Data Port 1. Alternatively, as RX_D3_N, this pin can function as part of the LVDS 6-bit RX differential output bus with internal LVDS termination.
K9	I/O	P1_D4/RX_D2_N	Digital Data Port P1/Receive Differential Output Bus. This is a dual function pin. As P1_D4, it functions as part of the 12-bit bidirectional parallel CMOS level Data Port 1. Alternatively, as RX_D2_N, this pin can function as part of the LVDS 6-bit RX differential output bus with internal LVDS termination.

Pin No.	Type <sup>1</sup>	Mnemonic	Description
K10	I/O	P1_D2/RX_D1_N	Digital Data Port P1/Receive Differential Output Bus. This is a dual function pin. As P1_D2, it functions as part of the 12-bit bidirectional parallel CMOS level Data Port 1. Alternatively, as RX_D1_N, this pin can function as part of the LVDS 6-bit RX differential output bus with internal LVDS termination.
K11	I/O	P1_D0/RX_D0_N	Digital Data Port P1/Receive Differential Output Bus. This is a dual function pin. As P1_D0, it functions as part of the 12-bit bidirectional parallel CMOS level Data Port 1. Alternatively, as RX_D0_N, this pin can function as part of the LVDS 6-bit RX differential output bus with internal LVDS termination.
L4	I	RBIAS	Bias Input Reference. Connect this pin through a 14.3 kΩ (1% tolerance) resistor to ground.
L5	I	AUXADC	Auxiliary ADC Input. If this pin is unused, tie it to ground.
L6	O	SPI_DO	SPI Serial Data Output in 4-Wire Mode, or High-Z in 3-Wire Mode.
M1, M2	I	RX1A_P, RX1A_N	Receive Channel 1 Differential Input A. Alternatively, each pin can be used as a single-ended input. Tie unused pins to ground.
M5	I	TX_MON1	Transmit Channel 1 Power Monitor Input. When this pin is unused, tie it to ground.
M7, M8	O	TX1A_P, TX1A_N	Transmit Channel 1 Differential Output A. Tie unused pins to 1.3 V.
M9, M10	O	TX1B_P, TX1B_N	Transmit Channel 1 Differential Output B. Tie unused pins to 1.3 V.
M11, M12	I	XTALP, XTALN	Reference Frequency Crystal Connections. When a crystal is used, connect it between these two pins. When an external clock source is used, connect it to XTALN and leave XTALP unconnected.

<sup>1</sup> I is input, O is output, I/O is input/output, and DNC is do not connect.

# TYPICAL PERFORMANCE CHARACTERISTICS

## 800 MHz FREQUENCY BAND

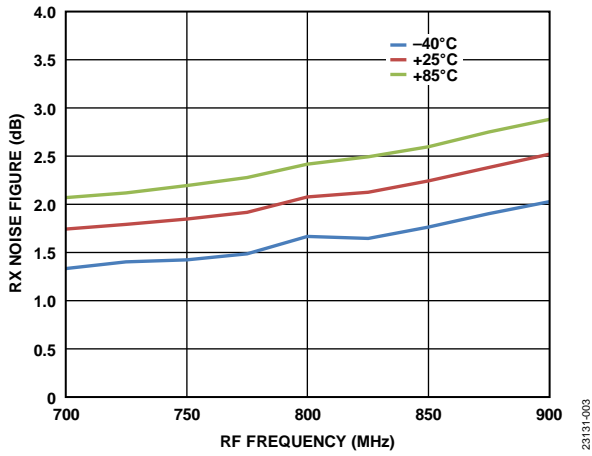

Figure 3. RX Noise Figure vs. RF Frequency

23131-003

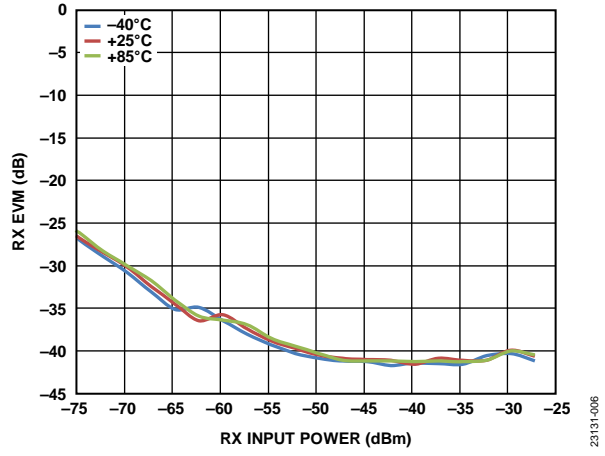

Figure 6. RX EVM vs. RX Input Power, 64 Quadrature Amplitude Modulation (QAM) LTE 10 MHz Mode, 19.2 MHz Reference Clock

23131-006

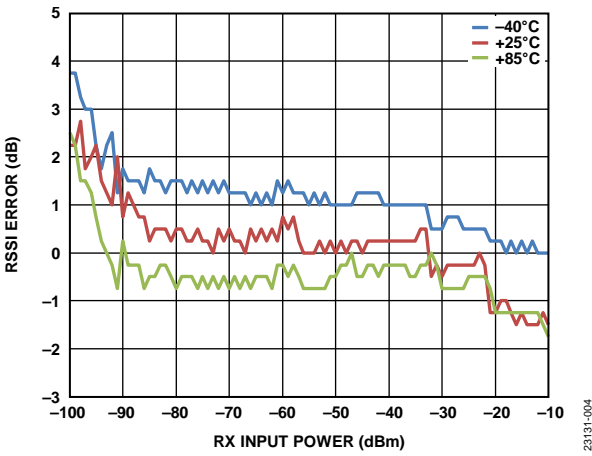

Figure 4. RSSI Error vs. RX Input Power, LTE 10 MHz Modulation (Referenced to -50 dBm Input Power at 800 MHz)

23131-004

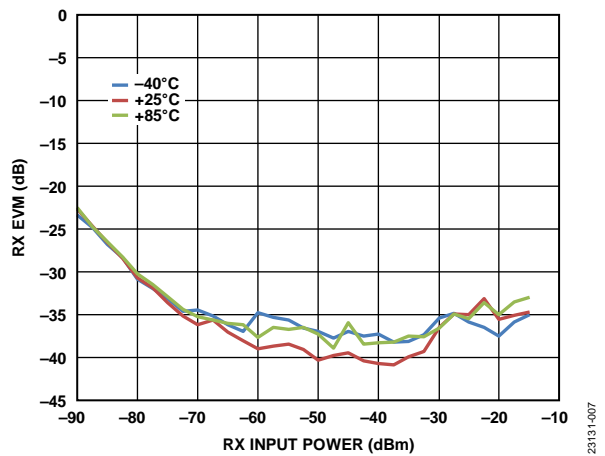

Figure 7. RX EVM vs. RX Input Power, GSM Mode, 30.72 MHz Reference Clock (Doubled Internally for RF Synthesizer)

23131-007

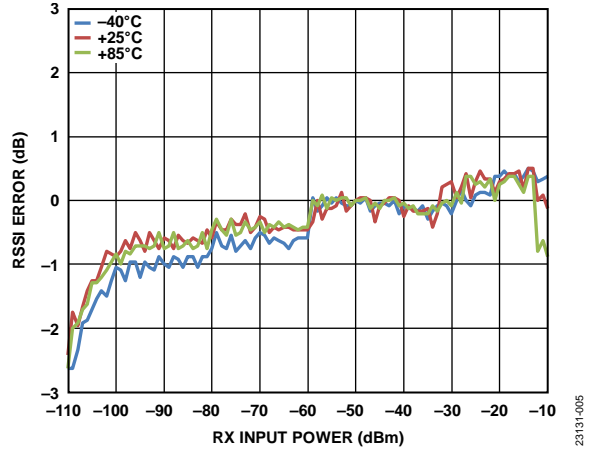

Figure 5. RSSI Error vs. RX Input Power, Edge Modulation (Referenced to -50 dBm Input Power at 800 MHz)

23131-005

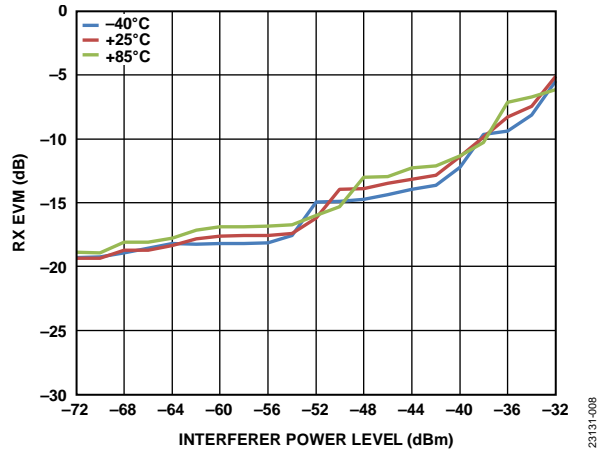

Figure 8. RX EVM vs. Interferer Power Level, LTE 10 MHz Signal of Interest with Input Power ( $P_{IN}$ ) = -82 dBm, 5 MHz Orthogonal Frequency Division Multiplexing (OFDM) Blocker at 7.5 MHz Offset

23131-008

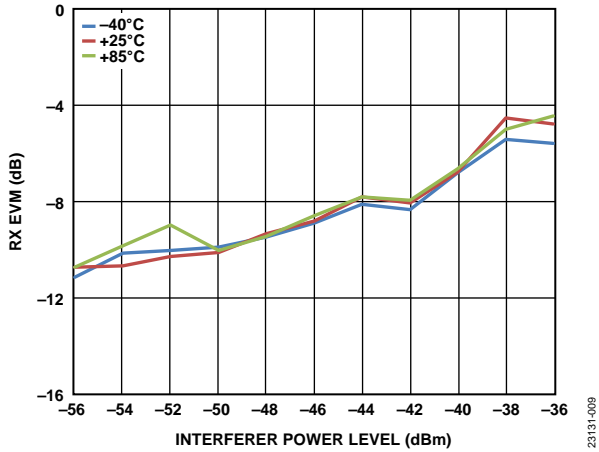

Figure 9. RX EVM vs. Interferer Power Level, LTE 10 MHz Signal of Interest with  $P_{IN} = -90$  dBm, 5 MHz OFDM Blocker at 17.5 MHz Offset

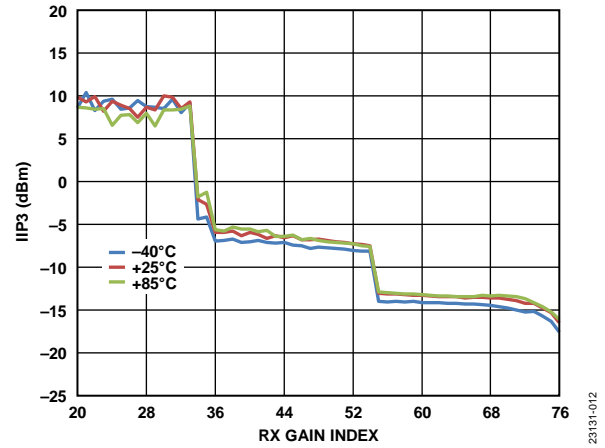

Figure 12. IIP3 vs. RX Gain Index,  $f_1 = 1.45$  MHz,  $f_2 = 2.89$  MHz, GSM Mode

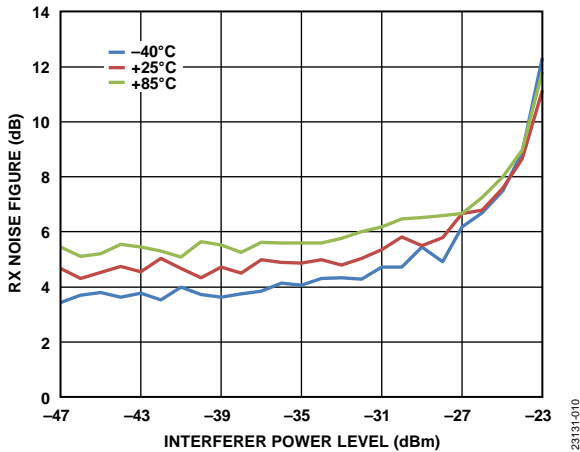

Figure 10. RX Noise Figure vs. Interferer Power Level, Edge Signal of Interest with  $P_{IN} = -90$  dBm, Continuous Wave Blocker at 3 MHz Offset, Gain Index = 64

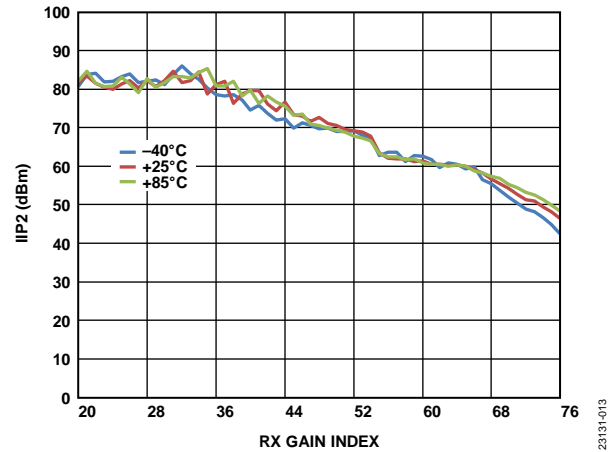

Figure 13. IIP2 vs. RX Gain Index,  $f_1 = 2.00$  MHz,  $f_2 = 2.01$  MHz, GSM Mode

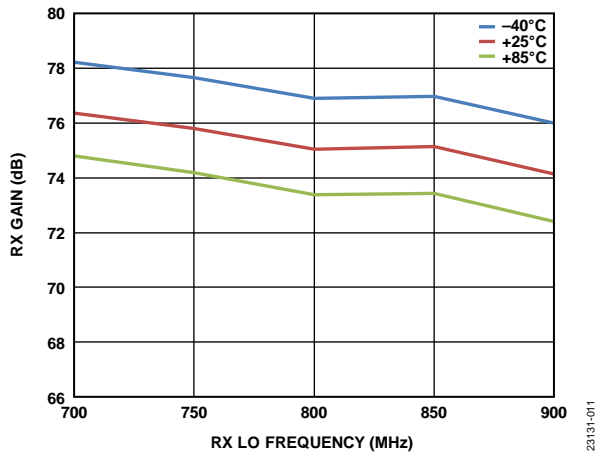

Figure 11. RX Gain vs. RX LO Frequency, Gain Index = 76 (Maximum Setting)

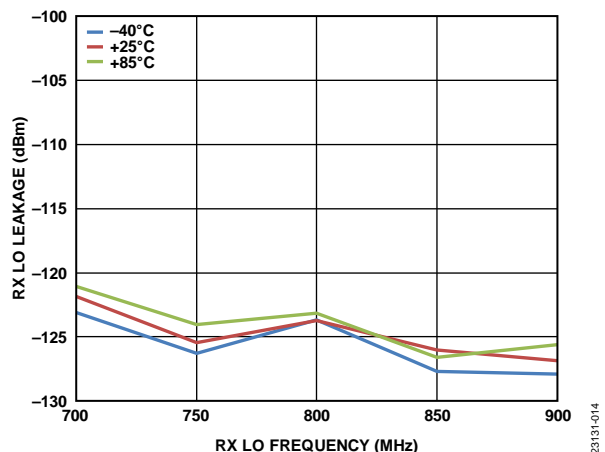

Figure 14. RX LO Leakage vs. RX LO Frequency

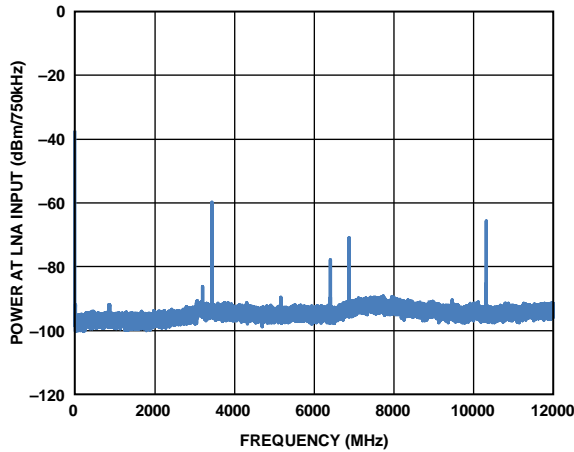

Figure 15. Power at LNA Input vs. Frequency, DC to 12 GHz, Receive LO Frequency ( $f_{LO\_RX}$ ) = 800 MHz, LTE 10 MHz, Transmit LO Frequency ( $f_{LO\_TX}$ ) = 860 MHz

23131-015

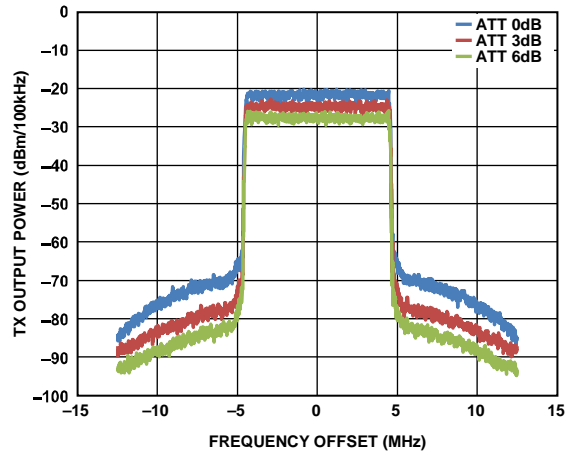

Figure 18. TX Output Power vs. Frequency Offset from Carrier Frequency,  $f_{LO\_TX}$  = 800 MHz, LTE 10 MHz Downlink (Digital Attenuation Variations Shown)

23131-018

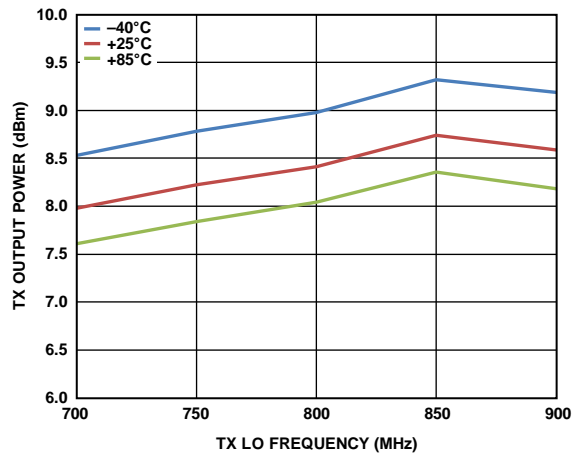

Figure 16. TX Output Power vs. TX LO Frequency, Attenuation Setting = 0 dB, Single-Tone Output

23131-016

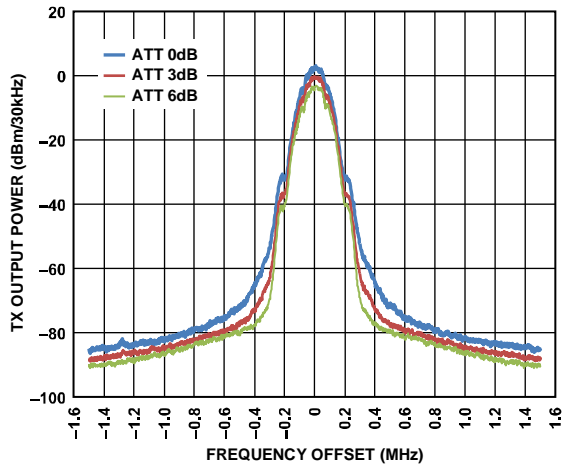

Figure 19. TX Output Power vs. Frequency Offset from Carrier Frequency,  $f_{LO\_TX}$  = 800 MHz, GSM Downlink (Digital Attenuation Variations Shown), 3 MHz Range

23131-019

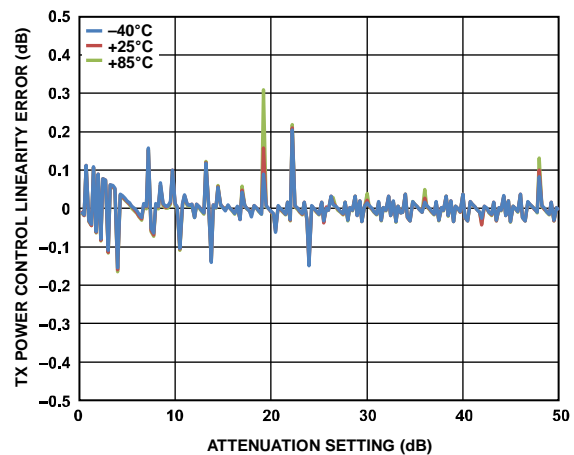

Figure 17. TX Power Control Linearity Error vs. Attenuation Setting

23131-017

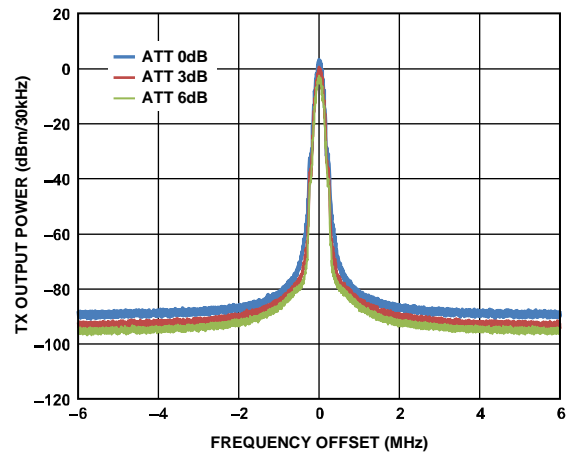

Figure 20. TX Output Power vs. Frequency Offset from Carrier Frequency,  $f_{LO\_TX}$  = 800 MHz, GSM Downlink (Digital Attenuation Variations Shown), 12 MHz Range

23131-020

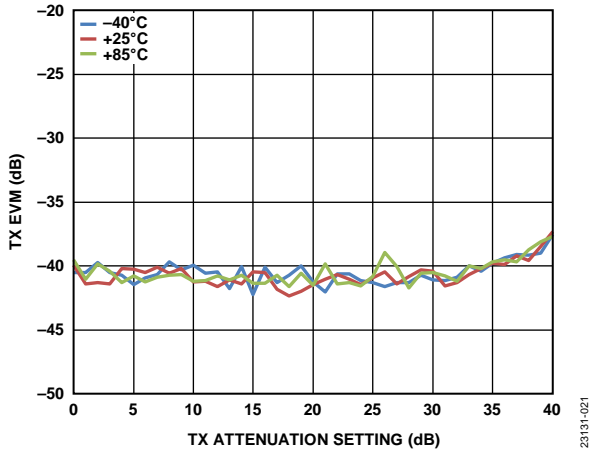

Figure 21. TX EVM vs. TX Attenuation Setting,  $f_{LO\_TX} = 800$  MHz, LTE 10 MHz, 64 QAM Modulation, 19.2 MHz Reference Clock

23131-021

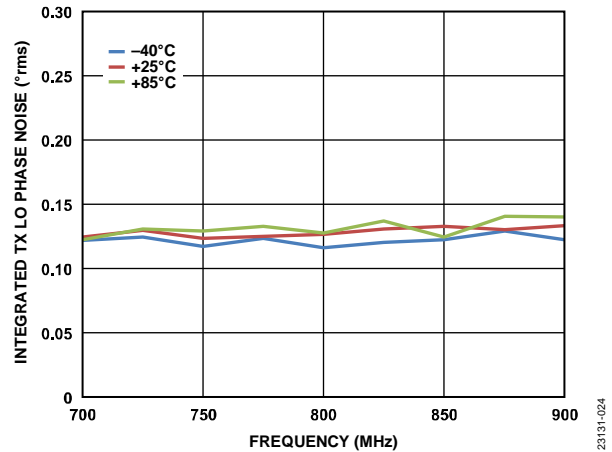

Figure 24. Integrated TX LO Phase Noise vs. Frequency, 30.72 MHz Reference Clock (Doubled Internally for RF Synthesizer)

23131-024

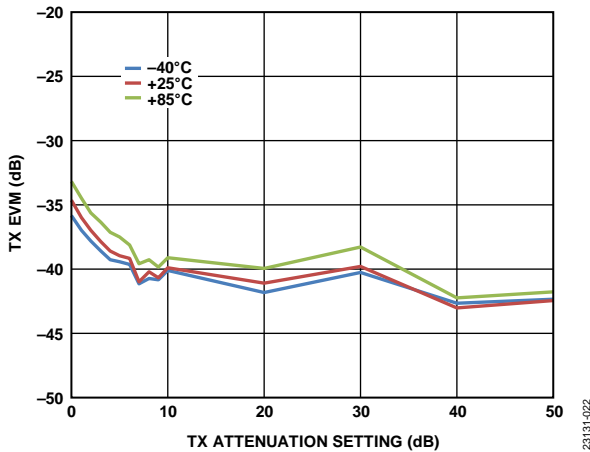

Figure 22. TX EVM vs. TX Attenuation Setting,  $f_{LO\_TX} = 800$  MHz, GSM Modulation, 30.72 MHz Reference Clock (Doubled Internally for RF Synthesizer)

23131-022

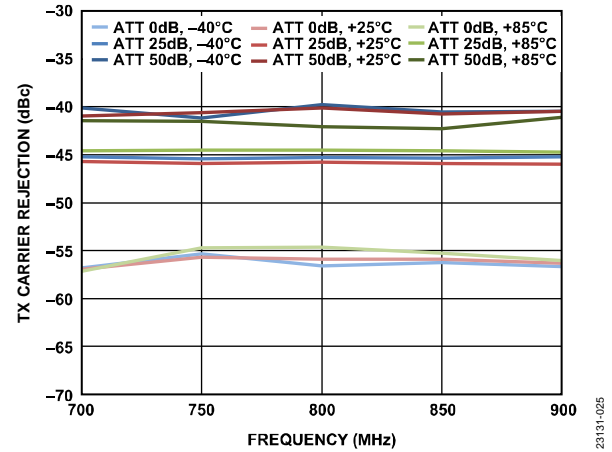

Figure 25. TX Carrier Rejection vs. Frequency

23131-025

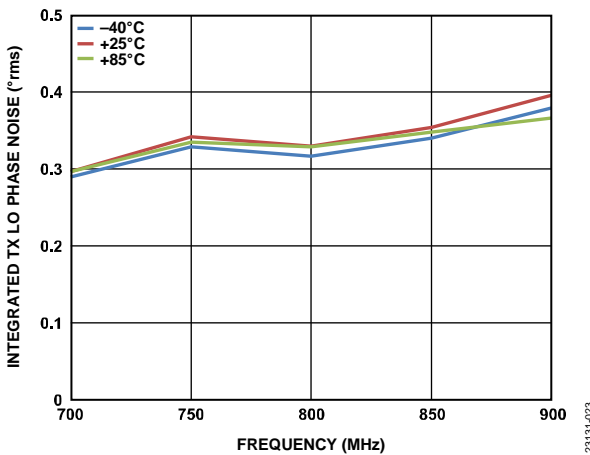

Figure 23. Integrated TX LO Phase Noise vs. Frequency, 19.2 MHz Reference Clock

23131-023

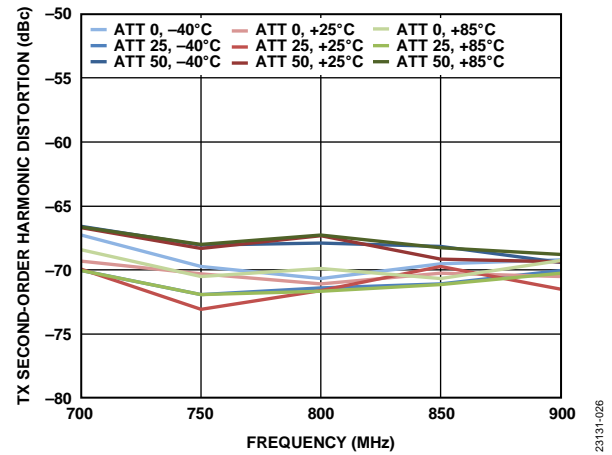

Figure 26. TX Second-Order Harmonic Distortion vs. Frequency

23131-026



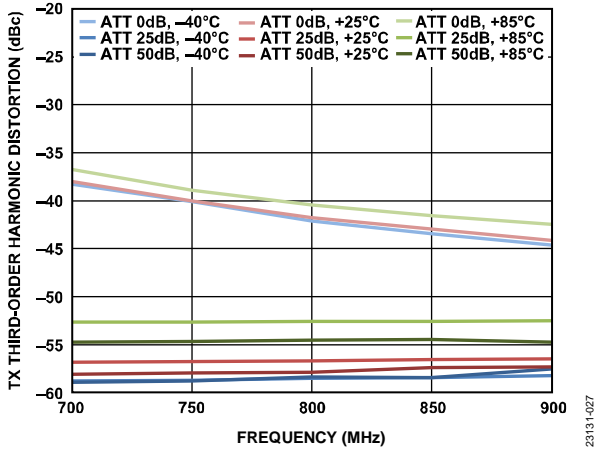

Figure 27. TX Third-Order Harmonic Distortion vs. Frequency

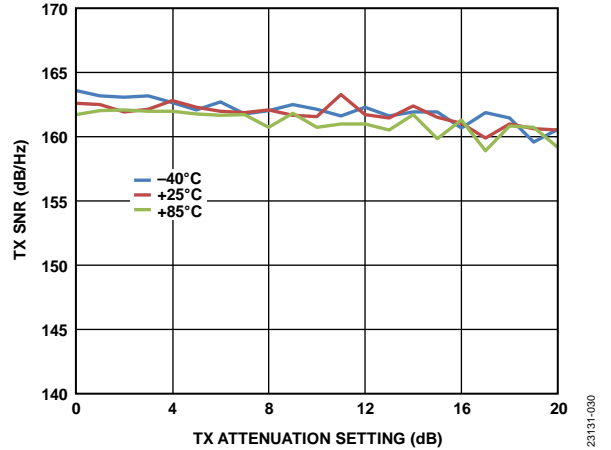

Figure 30. TX SNR vs. TX Attenuation Setting, GSM Signal of Interest with Noise Measured at 20 MHz Offset

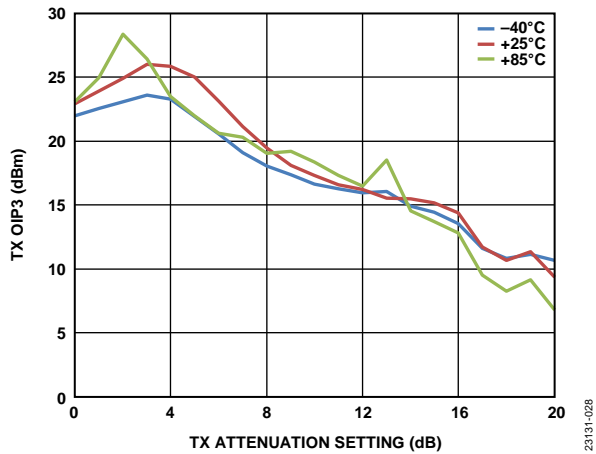

Figure 28. TX OIP3 vs. TX Attenuation Setting

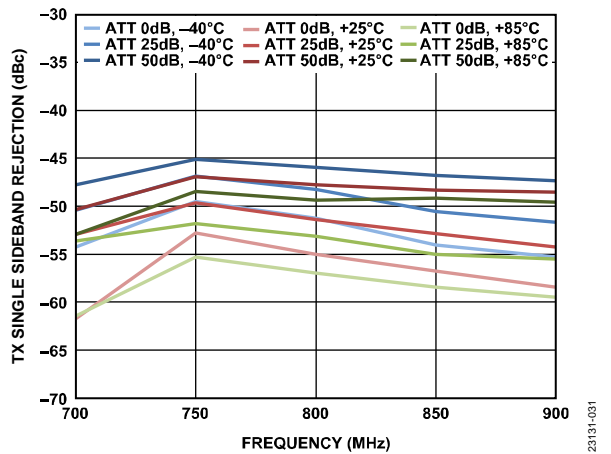

Figure 31. TX Single Sideband Rejection vs. Frequency, 1.5375 MHz Offset

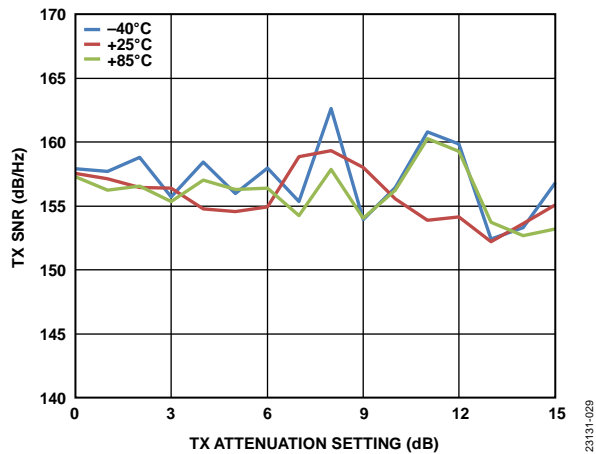

Figure 29. TX SNR vs. TX Attenuation Setting, LTE 10 MHz Signal of Interest with Noise Measured at 90 MHz Offset

2.4 GHz FREQUENCY BAND

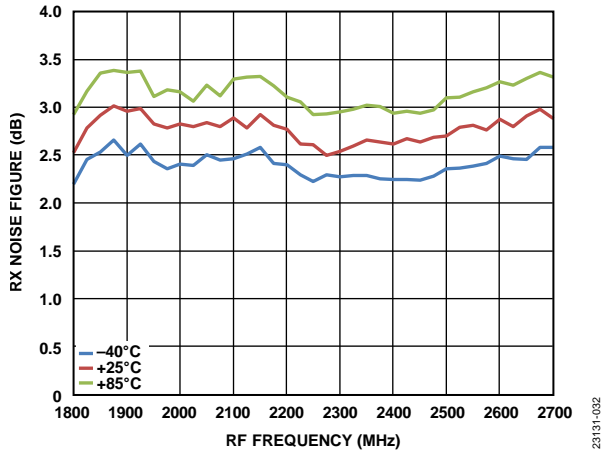

Figure 32. RX Noise Figure vs. RF Frequency

23131-032

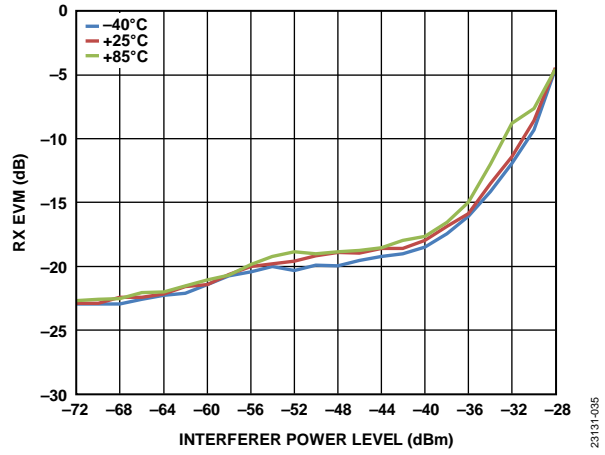

Figure 35. RX EVM vs. Interferer Power Level, LTE 20 MHz Signal of Interest with  $P_{IN} = -75$  dBm, LTE 20 MHz Blocker at 20 MHz Offset

23131-035

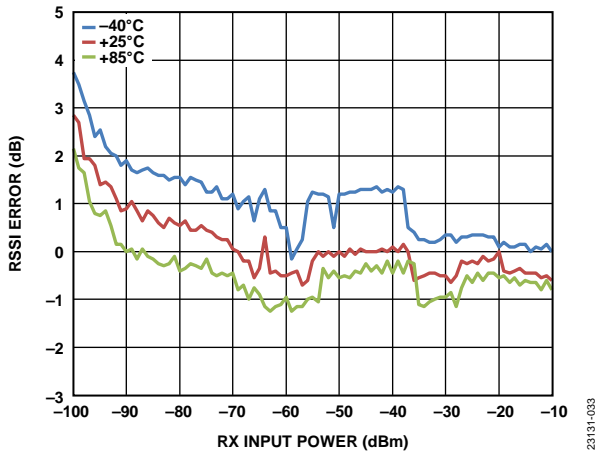

Figure 33. RSSI Error vs. RX Input Power, Referenced to  $-50$  dBm Input Power at 2.4 GHz

23131-033

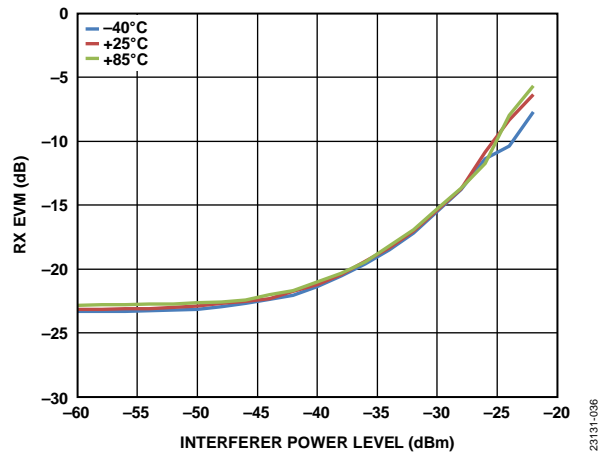

Figure 36. RX EVM vs. Interferer Power Level, LTE 20 MHz Signal of Interest with  $P_{IN} = -75$  dBm, LTE 20 MHz Blocker at 40 MHz Offset

23131-036

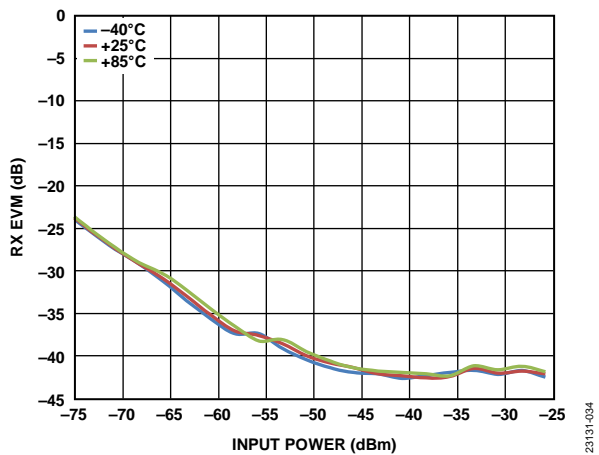

Figure 34. RX EVM vs. Input Power, 64 QAM LTE 20 MHz Mode, 40 MHz Reference Clock

23131-034

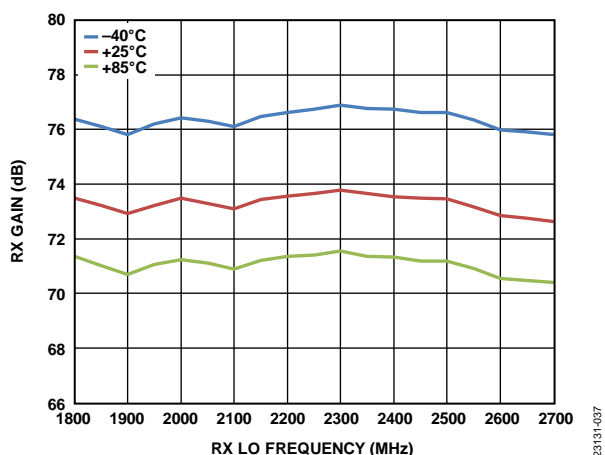

Figure 37. RX Gain vs. RX LO Frequency, Gain Index = 76 (Maximum Setting)

23131-037

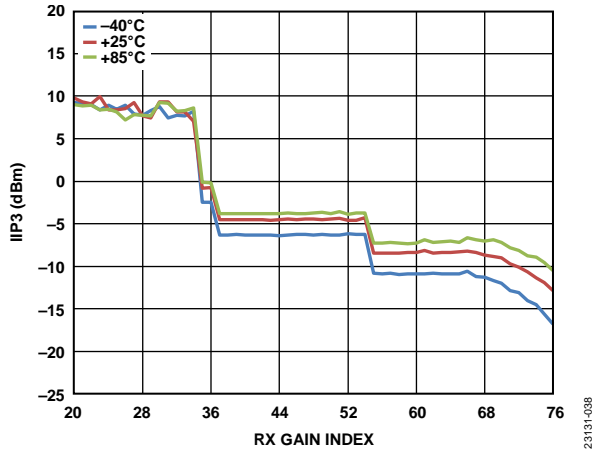

Figure 38. IIP3 vs. RX Gain Index,  $f_1 = 30$  MHz,  $f_2 = 61$  MHz

23131-038

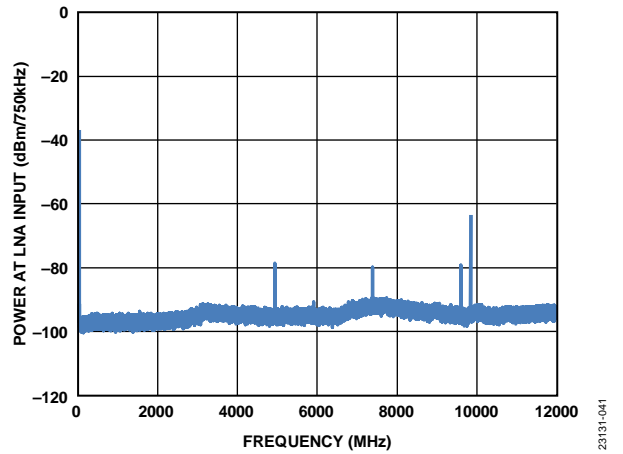

Figure 41. Power at LNA Input vs. Frequency, DC to 12 GHz,  $f_{LO\_RX} = 2.4$  GHz, LTE 20 MHz,  $f_{LO\_TX} = 2.46$  GHz

23131-041

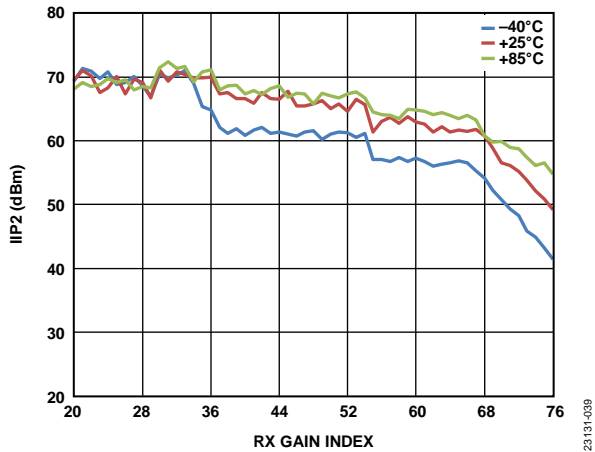

Figure 39. IIP2 vs. RX Gain Index,  $f_1 = 60$  MHz,  $f_2 = 61$  MHz

23131-039

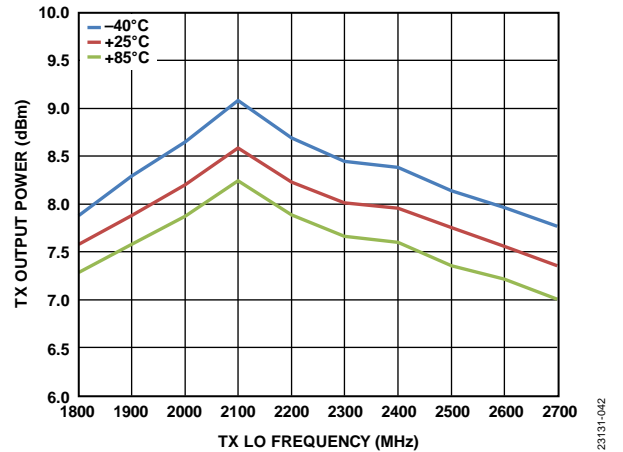

Figure 42. TX Output Power vs. TX LO Frequency, Attenuation Setting = 0 dB, Single-Tone Output

23131-042

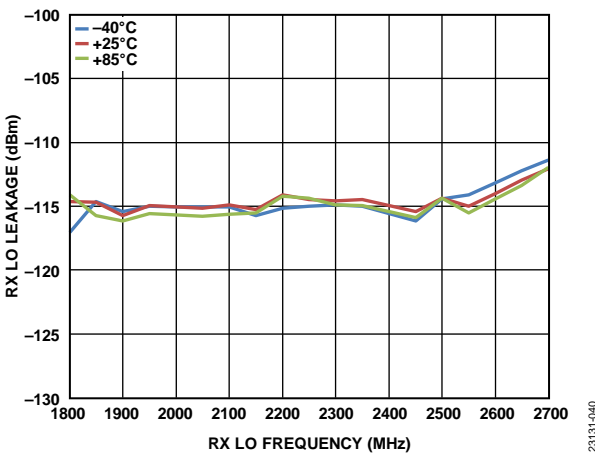

Figure 40. RX LO Leakage vs. RX LO Frequency

23131-040

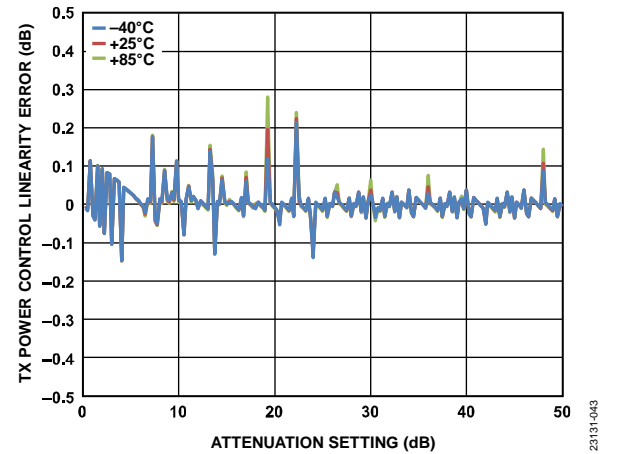

Figure 43. TX Power Control Linearity Error vs. Attenuation Setting

23131-043

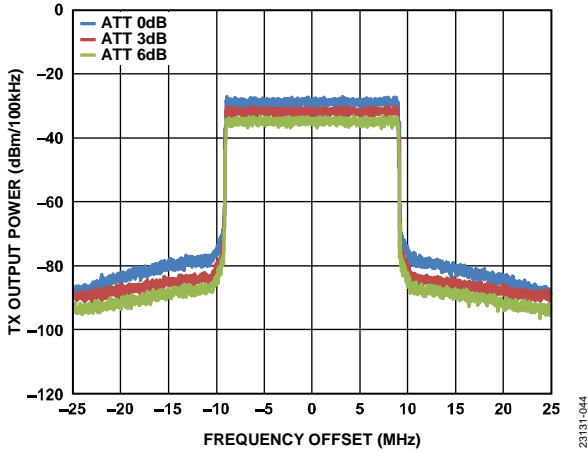

Figure 44. TX Output Power vs. Frequency Offset from Carrier Frequency,  $f_{LO\_TX} = 2.3$  GHz, LTE 20 MHz Downlink (Digital Attenuation Variations Shown)

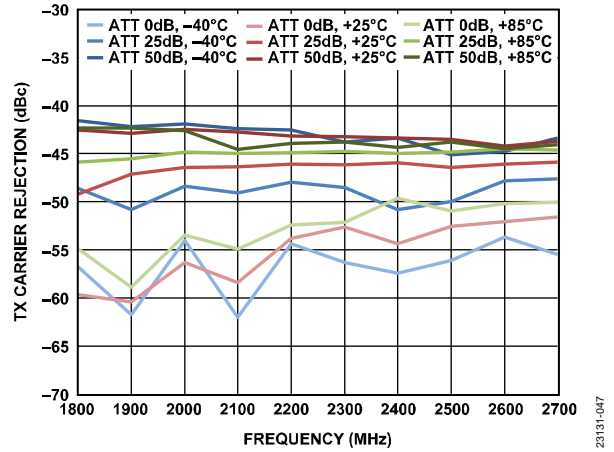

Figure 47. TX Carrier Rejection vs. Frequency

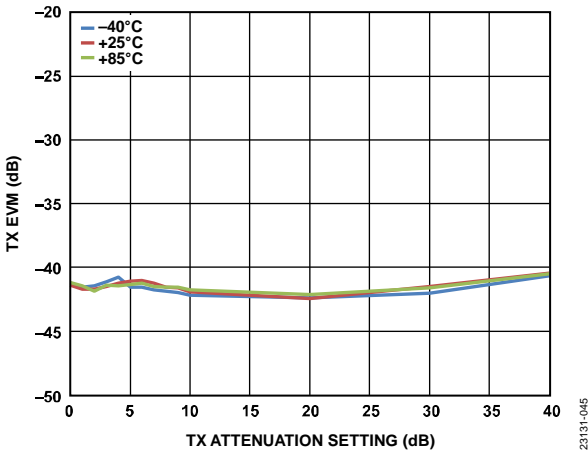

Figure 45. TX EVM vs. TX Attenuation Setting, 40 MHz Reference Clock, LTE 20 MHz, 64 QAM Modulation

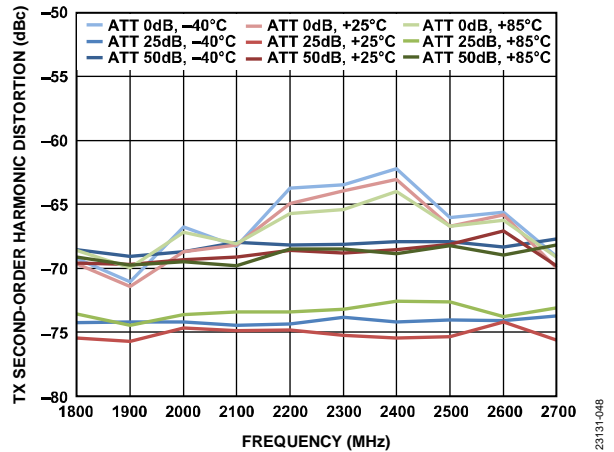

Figure 48. TX Second-Order Harmonic Distortion vs. Frequency

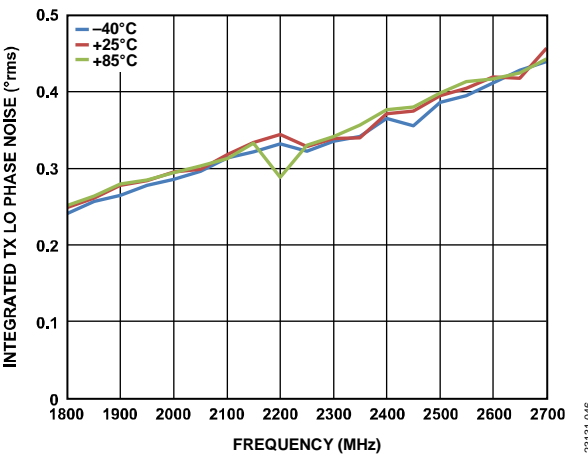

Figure 46. Integrated TX LO Phase Noise vs. Frequency, 40 MHz Reference Clock

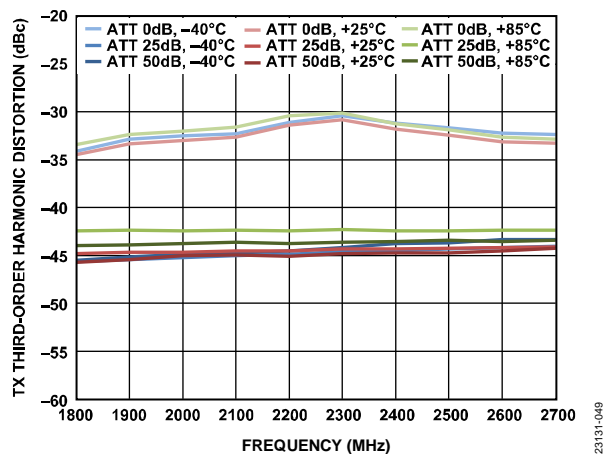

Figure 49. TX Third-Order Harmonic Distortion vs. Frequency

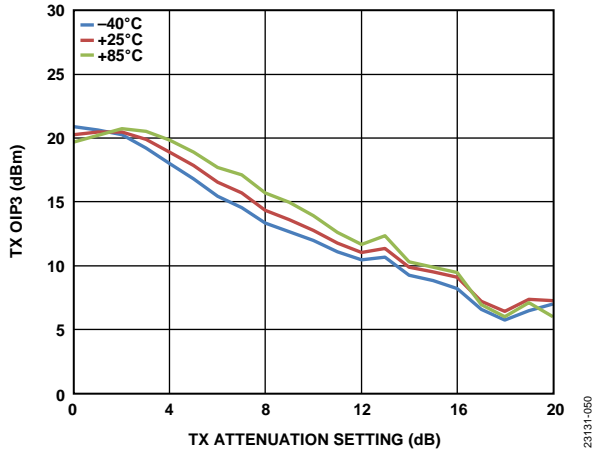

Figure 50. TX OIP3 vs. TX Attenuation Setting

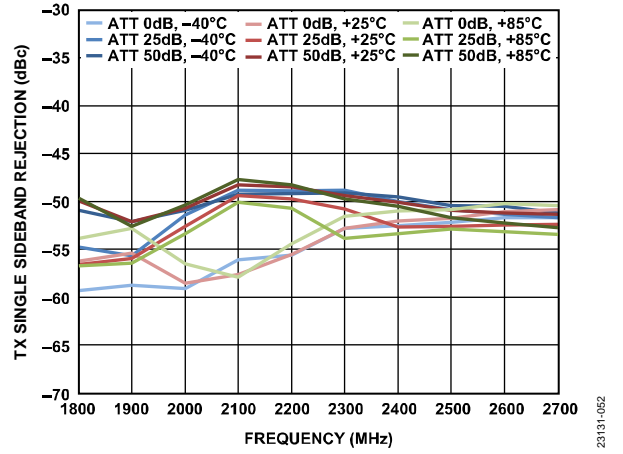

Figure 52. TX Single Sideband Rejection vs. Frequency, 3.075 MHz Offset

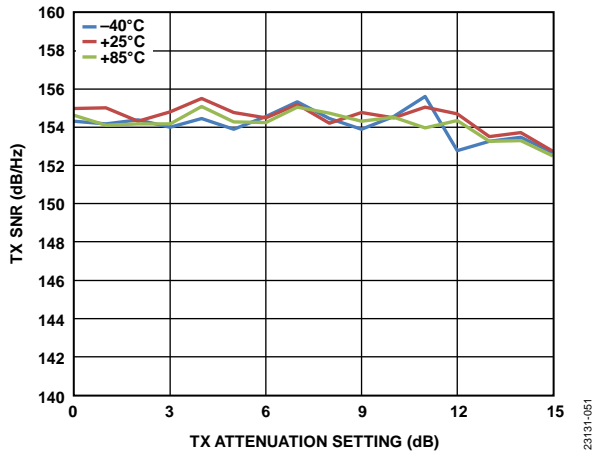

Figure 51. TX SNR vs. TX Attenuation Setting, LTE 20 MHz Signal of Interest with Noise Measured at 90 MHz Offset

5.5 GHz FREQUENCY BAND

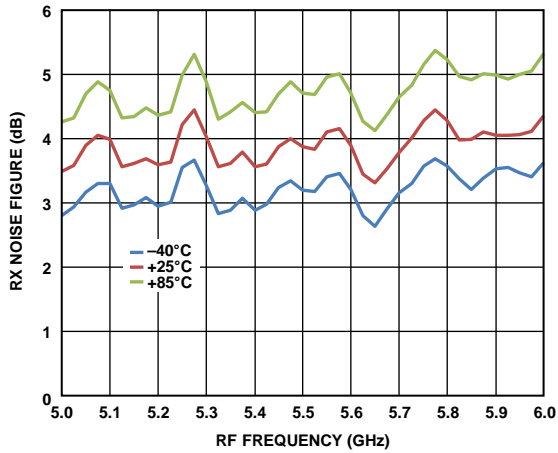

Figure 53. RX Noise Figure vs. RF Frequency

23131-053

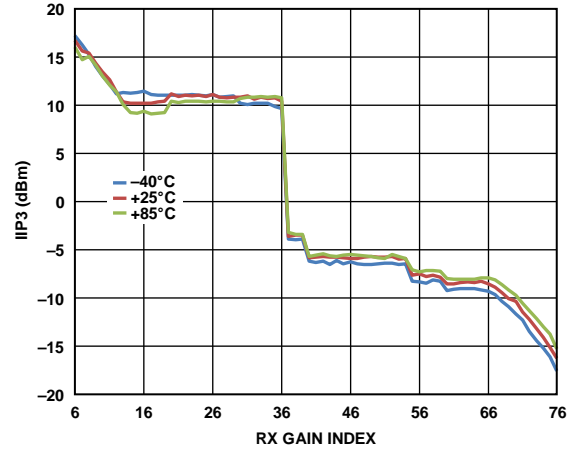

Figure 56. IIP3 vs. RX Gain Index, f1 = 50 MHz, f2 = 101 MHz

23131-059

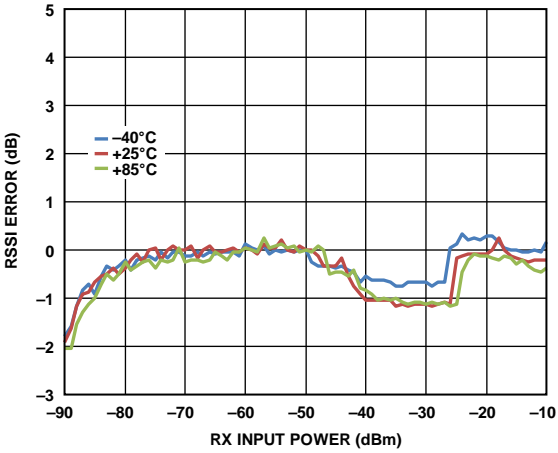

Figure 54. RSSI Error vs. RX Input Power, Referenced to -50 dBm Input Power at 5.8 GHz

23131-054

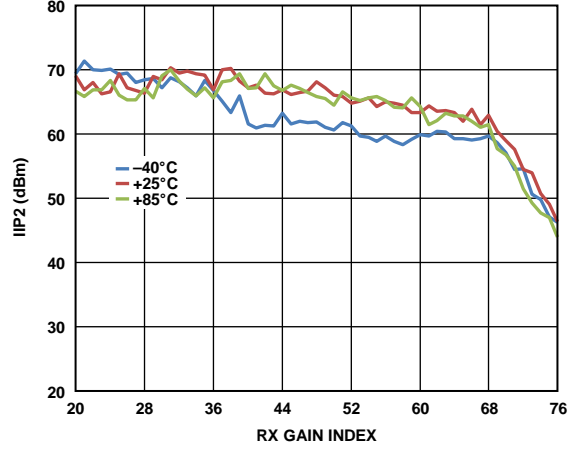

Figure 57. IIP2 vs. RX Gain Index, f1 = 70 MHz, f2 = 71 MHz

23131-060

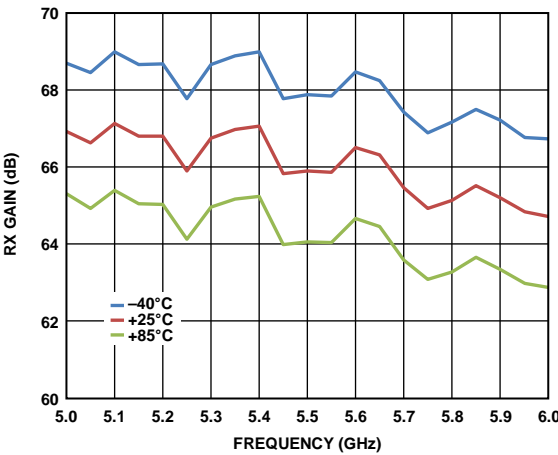

Figure 55. RX Gain vs. Frequency, Gain Index = 76 (Maximum Setting)

23131-058

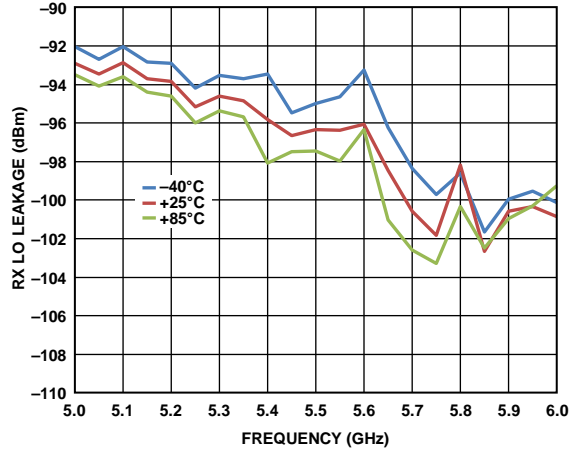

Figure 58. RX LO Leakage vs. Frequency

23131-061

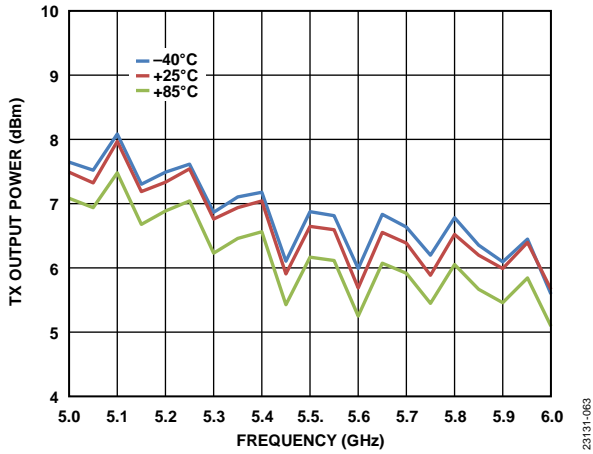

Figure 59. TX Output Power vs. Frequency, Attenuation Setting = 0 dB, Single Tone

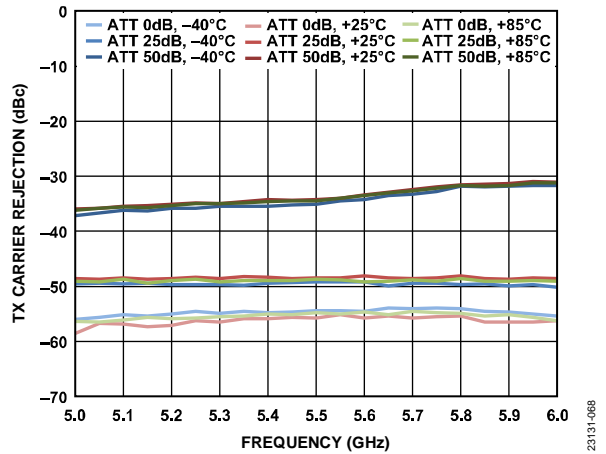

Figure 62. TX Carrier Rejection vs. Frequency

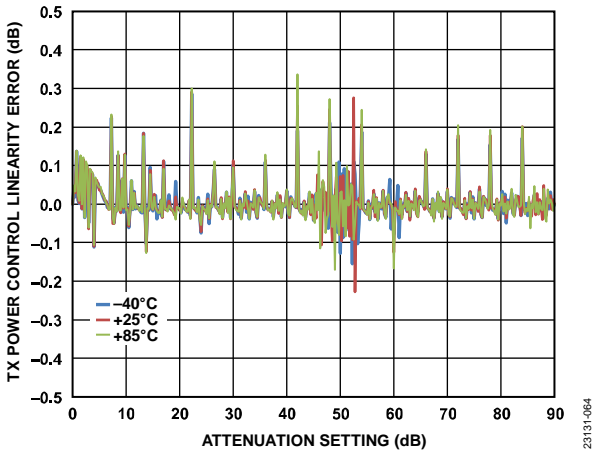

Figure 60. TX Power Control Linearity Error vs. Attenuation Setting

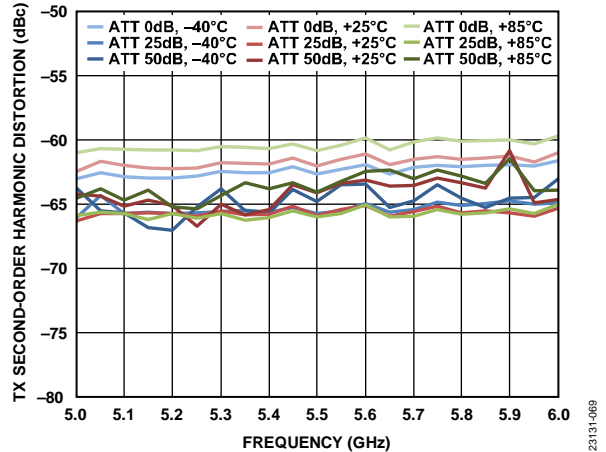

Figure 63. TX Second-Order Harmonic Distortion vs. Frequency

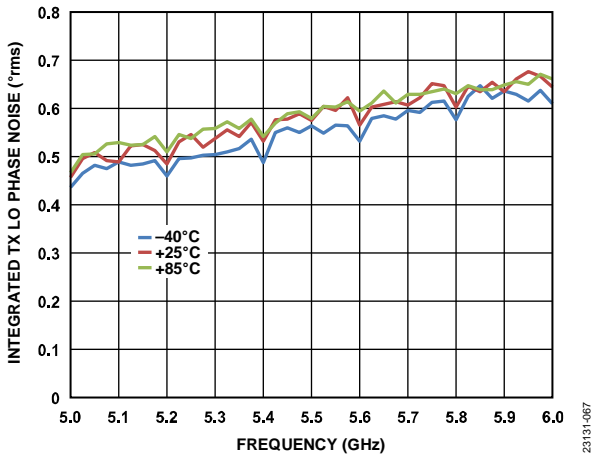

Figure 61. Integrated TX LO Phase Noise vs. Frequency, 40 MHz Reference Clock (Doubled Internally for RF Synthesizer)

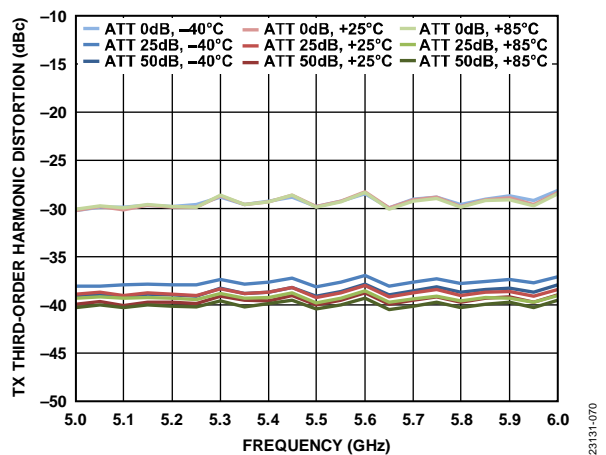

Figure 64. TX Third-Order Harmonic Distortion vs. Frequency

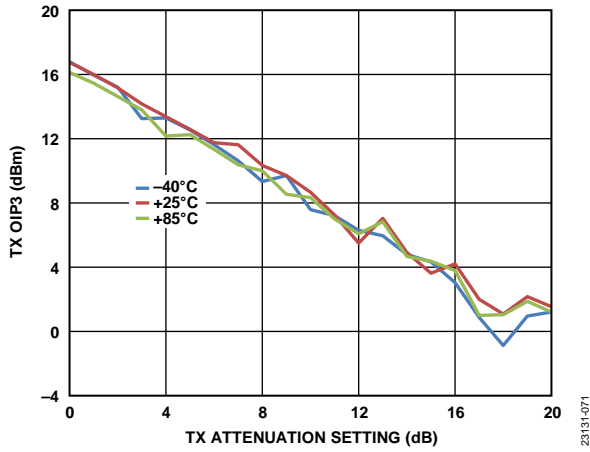

Figure 65. TX OIP3 vs. TX Attenuation Setting,  $f_{LO\_TX} = 5.8$  GHz

23131-071

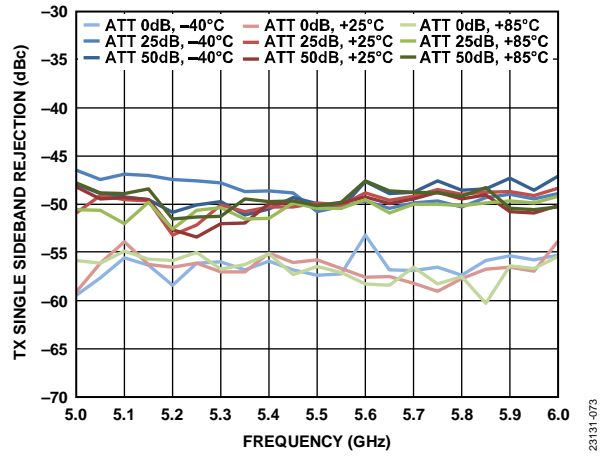

Figure 66. TX Single Sideband Rejection vs. Frequency, 7 MHz Offset

23131-073



# PACKAGING AND ORDERING INFORMATION

## OUTLINE DIMENSIONS

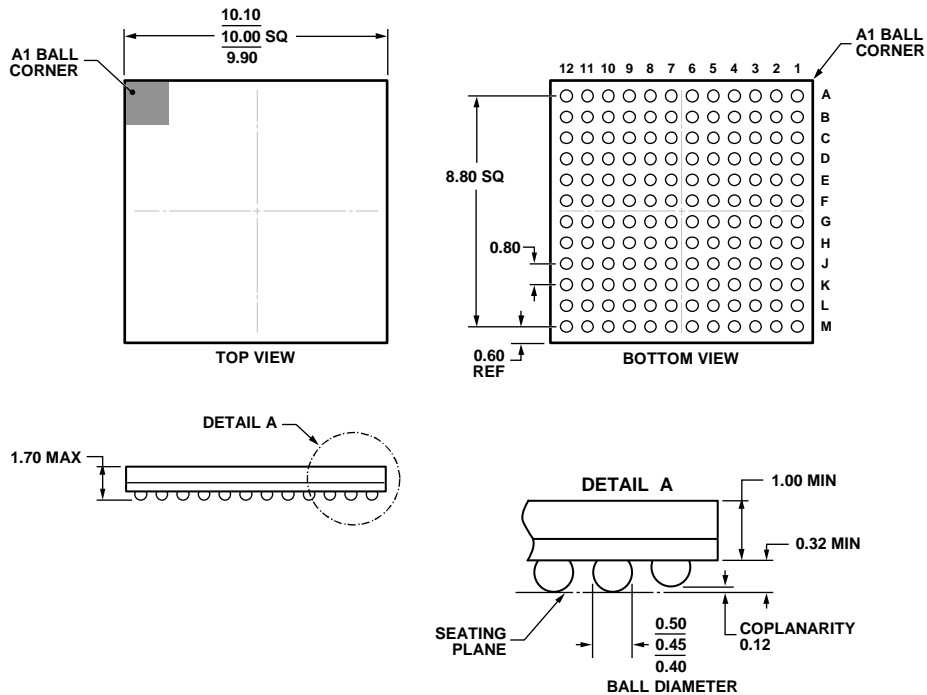

COMPLIANT TO JEDEC STANDARDS MO-275-EEAB-1.

11-18-2011-A

Figure 67. 144-Ball Chip Scale Package Ball Grid Array [CSP\_BGA] (BC-144-7)  
Dimensions shown in millimeters

## ORDERING GUIDE

Model <sup>1</sup>	Temperature Range	Package Description	Package Option
AD9361BBCZ-CSL	-40°C to +85°C	144-Ball Chip Scale Package Ball Grid Array [CSP_BGA]	BC-144-7

<sup>1</sup> Z = RoHS Compliant Part.