



# MAX9879 Evaluation Kit

Evaluates: MAX9879

## General Description

The MAX9879 evaluation kit (EV kit) is an assembled and tested PCB that evaluates the MAX9879. The MAX9879 is a stereo Class D audio subsystem with DirectDrive® headphone amplifiers communicating over a 2-wire I<sup>2</sup>C interface. The MAX9879 features user-defined input configuration, input gain, input source, output enable, and volume control. The microcontroller included on the EV kit, connected to the PC through the universal serial bus (USB) port, acts as the I<sup>2</sup>C master.

The MAX9879 EV kit also includes Windows® 2000/XP- and Windows Vista®-compatible software that provides a simple user interface for exercising the features of the MAX9879. The program is menu driven and offers a graphical user interface (GUI) complete with control buttons. The EV kit comes with the MAX9879ERV+ installed.

## Features

- ◆ 2.7V to 5.5V Single Supply
- ◆ Proven Audio PCB Layout
- ◆ On-Board Microcontroller to Generate I<sup>2</sup>C Commands
- ◆ USB-PC Connection (Cable Included)
- ◆ PCB Pads for User-Supplied I<sup>2</sup>C-Compatible Signals
- ◆ PCB Pads for Audio Input and Output Signals
- ◆ Windows 2000/XP- and Windows Vista (32-Bit)-Compatible Software
- ◆ Easy-to-Use, Menu-Driven Software
- ◆ Lead(Pb)-Free and RoHS Compliant
- ◆ Fully Assembled and Tested

## Ordering Information

PART	TYPE
MAX9879EVKIT+	EV Kit

+Denotes lead(Pb)-free and RoHS compliant.

## Component List

DESIGNATION	QTY	DESCRIPTION
C1, C3–C10, C17	10	0.1µF ±10%, 16V X7R ceramic capacitors (0603) Murata GRM188R71C104K
C2, C13, C15	3	10µF ±20%, 6.3V X5R ceramic capacitors (0805) Murata GRM21BR60J106M
C11, C12	2	10pF ±5%, 50V C0G ceramic capacitors (0603) Murata GRM1885C1H100J
C14, C16	2	1µF ±10%, 10V X5R ceramic capacitors (0603) Murata GRM188R61A105K
C18, C19	2	22pF ±5%, 50V C0G ceramic capacitors (0603) Murata GRM1885C1H220J

DESIGNATION	QTY	DESCRIPTION
C20	1	3300pF ±10%, 50V X7R ceramic capacitor (0603) Murata GRM188R71H332K
C21–C24, C34–C38, C51	10	0.22µF ±10%, 10V X5R ceramic capacitors (0402) Murata GRM155R61A224K
C25, C26, C27, C47	4	10pF ±5%, 50V C0G ceramic capacitors (0402) Murata GRM1555C1H100J
C28–C31, C39, C40, C41	7	1µF ±10%, 10V X5R ceramic capacitors (0402) Murata GRM155R61A105K
C32, C33, C48, C49	0	Not installed, capacitors (0603)

DirectDrive is a registered trademark of Maxim Integrated Products, Inc.

Windows and Windows Vista are registered trademarks of Microsoft Corp.



Maxim Integrated Products 1

**For pricing, delivery, and ordering information, please contact Maxim Direct at 1-888-629-4642, or visit Maxim's website at [www.maxim-ic.com](http://www.maxim-ic.com).**

# MAX9879 Evaluation Kit

## Component List (continued)

DESIGNATION	QTY	DESCRIPTION
C42, C43, C45, C50	4	0.1 $\mu$ F $\pm$ 10%, 10V X5R ceramic capacitors (0402) Murata GRM155R61A104K
C44, C46	2	33 $\mu$ F $\pm$ 20%, 6.3V tantalum capacitors (R case) AVX TLJR336M006R3000
D1	1	Green LED (0603)
FB1, FB6, FB7, FB11, FB12	0	Not installed, ferrite beads (0603)
FB2–FB5, FB8	5	250mA ferrite beads (0402) Murata BLM15HD102SN1
FB9, FB10	2	2A ferrite beads (0805) Murata BLM21PG221SN1
HPJK	1	3.5mm switched stereo jack
HPL, HPR	0	Not installed, test points
JU1, JU2	2	3-pin headers
JU3, JU4	2	2-pin headers
L1–L4	0	Not installed, inductors (6.2mm x 6.3mm x 3.5mm)
OUTR-, OUTL-	2	Test points, black
OUTR+, OUTL+	2	Test points, red
P1	1	USB type-B right-angle male receptacle
R1	1	0 $\Omega$ $\pm$ 5% resistor (0603)
R2	1	220 $\Omega$ $\pm$ 5% resistor (0603)
R3	1	10k $\Omega$ $\pm$ 5% resistor (0603)
R4	1	2.2k $\Omega$ $\pm$ 5% resistor (0603)

DESIGNATION	QTY	DESCRIPTION
R5	1	1.5k $\Omega$ $\pm$ 5% resistor (0603)
R6, R7	2	27 $\Omega$ $\pm$ 5% resistors (0603)
R8, R9	2	2k $\Omega$ $\pm$ 5% resistors (0603)
R10–R13	4	22 $\Omega$ $\pm$ 5% resistors (0603)
R14, R15	2	10 $\Omega$ $\pm$ 5% resistors (0603)
U1	1	Stereo audio subsystem (30 UCSP™) Maxim MAX9879ERV+
U2	1	32-bit microcontroller (68 QFN-EP*) Maxim MAXQ2000-RAX+
U3	1	93C46 EEPROM (8 SO)
U4	1	UART-to-USB converter (32 TQFP)
U5	1	3.3V regulator (5 SC70) Maxim MAX8511EXK33+
U6	1	2.5V regulator (5 SC70) Maxim MAX8511EXK25+
Y1	1	16MHz crystal (HCM49) Hong Kong X'tals SSM1600000E18FAF
Y2	1	6MHz crystal (HCM49) Hong Kong X'tals SSL6000000E18FAF
—	4	Shunts
—	4	22 $\mu$ H $\pm$ 20%, 1.29A inductors (L1–L4) TOKO #A916CY-220M
—	1	USB high-speed A-to-B cable, 6ft
—	1	PCB: MAX9879 Evaluation Kit+

\*EP = Exposed pad.

## Component Suppliers

SUPPLIER	PHONE	WEBSITE
AVX Corporation	843-946-0238	www.avxcorp.com
Hong Kong Xtal's Ltd.	852-35112388	www.hongkongcrystal.com
Murata Electronics North America, Inc.	770-436-1300	www.murata-northamerica.com
TOKO America, Inc.	847-297-0070	www.tokoam.com

**Note:** Indicate that you are using the MAX9879 when contacting these component suppliers.

UCSP is a trademark of Maxim Integrated Products, Inc.

# MAX9879 Evaluation Kit

## MAX9879 EV Kit Files

FILE	DESCRIPTION
INSTALL.EXE	Installs the EV kit files on your computer
MAX9879.EXE	Application program
FTD2XX.INF	USB driver file
UNINST.INI	Uninstalls the EV kit software
USB_Driver_Help.PDF	USB driver installation help file

Evaluates: MAX9879

### Quick Start

#### Recommended Equipment

- MAX9879 EV kit (USB cable included)
- A user-supplied Windows 2000/XP- or Windows Vista-compatible PC with a spare USB port
- 3.7V/1A DC power supply (VDD)
- One stereo audio source
- Two speakers
- One pair of headphones

**Note:** In the following sections, software-related items are identified by bolding. Text in **bold** refers to items directly from the EV kit software. Text in **bold and underlined** refers to items from the Windows operating system.

#### Procedure

The MAX9879 EV kit is fully assembled and tested. Follow the steps below to verify board operation.

**Caution: Do not turn on power supply until all connections are completed.**

- 1) Visit [www.maxim-ic.com/evkitsoftware](http://www.maxim-ic.com/evkitsoftware) to download the latest version of the EV kit software, 9879Rxx.ZIP. Save the EV kit software to a temporary folder and uncompress the ZIP file.
- 2) Install the EV kit software on your computer by running the INSTALL.EXE program inside the temporary folder. The program files are copied and icons are created in the Windows **Start | Programs** menu.
- 3) Verify all jumpers (JU1–JU4) are in their default positions, as shown in Table 1.
- 4) Connect the left and right audio source outputs to the INA1 and INA2 pads of the EV kit.
- 5) Connect the speakers across the OUT\_+ and OUT\_- test points.
- 6) Connect the headphone to the HPJK stereo jack.
- 7) Connect the 3.7V/1A DC power supply to the VDD and the GND pads on the MAX9879 EV kit board.
- 8) Connect the USB cable from the PC to the EV kit board. A **New Hardware Found** window pops up when installing the USB driver for the first time. If you do not see a window that is similar to the one described above after 30s, remove the USB cable from the board and reconnect it. Administrator privileges are required to install the USB device driver on Windows.
- 9) Follow the directions of the **Add New Hardware Wizard** to install the USB device driver. Choose the **Search for the best driver for your device** option. Specify the location of the device driver to be **C:\Program Files\MAX9879** (default installation directory) using the **Browse** button. During device driver installation, Windows may show a warning message indicating that the device driver Maxim uses does not contain a digital signature. This is not an error condition and it is safe to proceed with installation. Refer to the USB\_Driver\_Help.PDF document included with the software for additional information.
- 10) Turn on the DC power supply.
- 11) Start the EV kit software by opening its icon in the **Start | Programs** menu. The EV kit software main window appears, as shown in Figure 1. Observe as the program automatically detects the address of the MAX9879 and starts the main program.

# MAX9879 Evaluation Kit

Table 1. MAX9879 EV Kit Jumper Descriptions (JU1–JU4)

JUMPER	SHUNT POSITION	DESCRIPTION
JU1	1-2*	Connects VCCIO to on-board +3.3V supply
	2-3	Connects VCCIO to user-supplied +3.3V supply
JU2	1-2*	Connects $\overline{\text{SHDN}}$ to VCCIO for normal operation
	2-3	Connects $\overline{\text{SHDN}}$ to ground for shutdown mode
JU3	1-2*	Connects to on-board SCL
	Open	Connects to user-supplied SCL
JU4	1-2*	Connects to on-board SDA
	Open	Connects to user-supplied SDA

\*Default position.

## Detailed Description of Software

### User Interface

The user interface (Figures 1 and 2) is easy to operate. Each button corresponds to bits in the command and configuration bytes. By pressing them, the correct I<sup>2</sup>C write operation is generated to update the internal registers of the MAX9879. The **Interface** group box (Figure 1) indicates the current **I<sup>2</sup>C Device Address**, **Register Address**, and the **Data Sent**, for the last write operation. This data is used to confirm proper device operation.

The MAX9879 EV kit software main window is divided into two tab sheets: **Main Control Panel** (Figure 1), for controlling the features of the IC, and **Registers** (Figure 2), for displaying a register overview of which bits are toggled.

### Main Control Panel

The user chooses the input settings of the MAX9879 by selecting the appropriate radio button within the **Input Configuration**, **Input Gain**, and **Input Source** group boxes. Within the **Speaker Amplifier** and **Headphone Amplifier** group boxes, each amplifier can be configured to its desired outputs.

### MAX9879 Master Controls

The software's **MAX9879 Master Controls** group box contains functions that control the MAX9879. The **Enabled** checkbox enables or disables the MAX9879. The **Zero Crossing Detection** checkbox enables or disables the zero-crossing detection (ZCD) during a volume-change operation. When enabled, the ZCD forces all volume adjustments to be made when the output signal is crossing zero, thus reducing audible clicks during volume changes. The **Reset** button sets the software to the EV kit power-on-reset (POR) configurations.

### Input Configuration

The MAX9879 EV kit software's **Input Configuration** group box configures the input channels for the MAX9879 EV kit. The MAX9879 EV kit accepts a pair of single-ended audio inputs for stereo-mode operation, or a pair of differential audio inputs for mono-mode operation. The single-ended input signals for the headphone are defined as IN\_1 (left) and IN\_2 (right). The differential input signal is defined as IN\_diff (IN\_2, IN\_1) for both headphone and speaker. Select **Stereo (S/E)** for single-ended stereo mode or **Mono (DIF)** for differential mono mode.

### Input Gain

The MAX9879 EV kit software's **Input Gain** group box selects the input-channel preamplifier gain for the MAX9879. The MAX9879 input-channel preamplifier gain is selectable between **0dB**, **+5.5dB**, or **+20dB** through corresponding radio buttons.

### Input Source

The MAX9879 EV kit software's **Input Source** group box selects the audio source for the MAX9879. The MAX9879 accepts input from channels **INA**, **INB**, or **INA + INB** through corresponding radio buttons.

### Speaker Amplifier

The MAX9879 EV kit software's **Speaker Amplifier** group box contains the **Speaker Output** group box and the **Speaker Volume** track bar. The **Speaker Output** group box enables, disables, or bypasses the speaker output. The **Speaker Volume** track bar also has an associated edit box to set the speaker volume.

Check the **Right** and **Left** checkboxes to enable or disable the speaker amplifiers on the MAX9879 EV kit. Check the **Bypass** checkbox to drive the speaker with an external amplifier. When the speaker amplifier

# MAX9879 Evaluation Kit

Evaluates: MAX9879

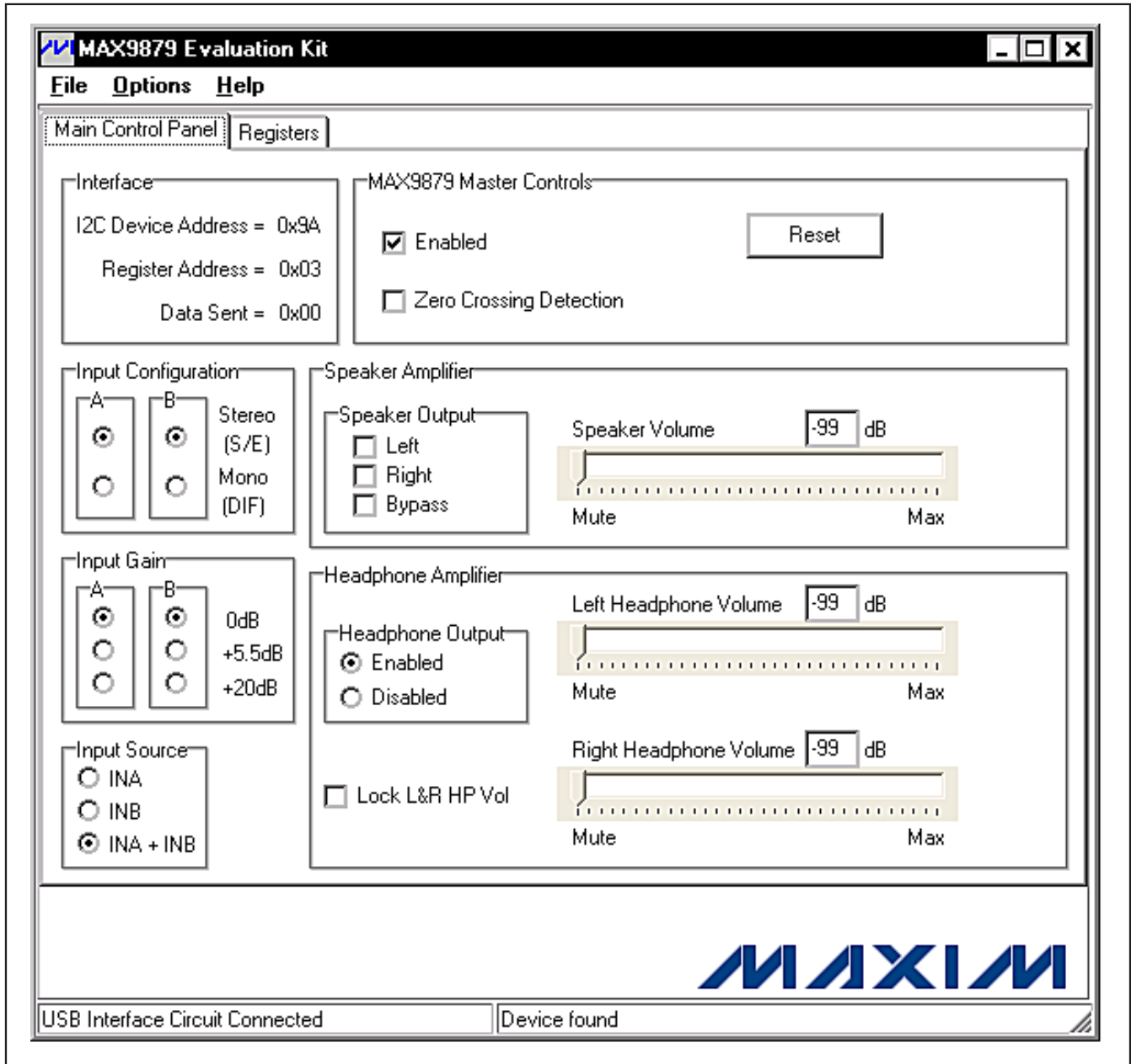

Figure 1. MAX9879 EV Kit Software Main Window (Main Control Panel Tab)

# MAX9879 Evaluation Kit

bypass is selected, the left speaker outputs (OUTL+ and OUTL-) are disconnected from the left speaker amplifier in the MAX9879 and connected to the RXIN+ and RXIN- pins of the MAX9879. This feature allows an external amplifier connection to the RXIN+ and RXIN- PCB pads to drive the speaker connected to the OUTL+ and OUTL- PCB pads of the MAX9879 EV kit.

Check only **Right** or **Left** checkboxes to enable just one speaker amplifier. When only one speaker amplifier is enabled, stereo input signals are summed to mono for output on the enabled speaker amplifier.

The **Speaker Volume** track bar sets the speaker volume between -99dB (mute) to 0dB (max). Similarly, the **Speaker Volume** edit box accepts a numerical value from -99dB (mute) to 0dB (max) to control the speaker amplifier volume.

## Headphone Amplifier

The MAX9879 EV kit software's **Headphone Amplifier** group box contains the **Headphone Output** group box, the **Left Headphone Volume** track bar, **Right Headphone Volume** track bar, and the **Lock L&R HP Vol** checkbox. The **Headphone Output** group box enables or disables headphone outputs. The **Left Headphone Volume** and **Right Headphone Volume** track bars also have an associated edit box to set the headphone volume.

Select the **Enabled** or **Disabled** radio buttons to enable or disable the headphone amplifier on the MAX9879 EV kit.

The **Left Headphone Volume** and **Right Headphone Volume** track bars set the left and right headphone volume, respectively, to between -99dB (mute) to 0dB (max). Similarly, the **Left Headphone Volume** and **Right Headphone Volume** edit boxes accept numerical values from -99dB (mute) to 0dB (max) to control the left and right headphone volume, respectively.

Check the **Lock L&R HP Vol** checkbox to lock the **Left Headphone Volume** and **Right Headphone Volume** track bar. When the **Lock L&R HP Vol** checkbox is checked, both **Left Headphone Volume** and **Right Headphone Volume** track bars move simultaneously when either track bar position is changed.

## Registers

The MAX9879 EV kit software **Registers** tab sheet (Figure 2) displays the data bit logic-level status for each individual register. A data bit shown in bold indi-

cates a logic-high, while nonbolded data bits indicate a logic-low. Refer to the MAX9879 IC data sheet for detailed information on the registers and data bits.

## Advanced User Interface

There are two methods for communicating with the MAX9879: through the normal user-interface main window or through the I<sup>2</sup>C commands available by selecting **Options | Interface (Advanced Users)**. A display pops up that allows the SMBus™/I<sup>2</sup>C-compatible protocols, such as read byte and write byte, to be executed. The only SMBus/I<sup>2</sup>C-compatible protocols used by the MAX9879 are:

- **1: SMBusWriteByte(addr,cmd,data8)**
- **4: SMBusReadByte(addr,cmd) →data8**

The combo and edit boxes accept numeric data in hexadecimal and should be prefixed by 0x. See Figure 3 for an example of this tool.

In this example, the software is writing 0x2F to device address 1001101(r/w) binary, and register address 0x02.

## Detailed Description of Hardware

The MAX9879 EV kit evaluates the MAX9879 stereo Class D audio subsystem with DirectDrive headphone amplifiers communicating over a 2-wire I<sup>2</sup>C interface. The Class D audio power amplifier is capable of driving 715mW into an 8Ω speaker. The stereo headphone amplifier is capable of driving 58mW per channel into a pair of 16Ω stereo headphones. The EV kit demonstrates the MAX9879 features such as user-defined input configuration, input gain, input source, output enable, and volume control.

## External Amplifier

The Class D audio power amplifier can be bypassed, allowing an external amplifier to power the same speaker connected to the MAX9879 EV kit without requiring external switches. Connect the external amplifier output to the RXIN+, RXIN-, and GND PCB pads on the MAX9879 EV kit.

## Filterless Output

The MAX9879 EV kit's filterless outputs (OUT+ and OUT-) can be connected directly to a speaker load without any filtering. Use the OUT+ and OUT- test points to connect speaker directly to the MAX9879 outputs using twisted-pair cable. Do not install inductors L1-L4 when operating the EV kit in filterless mode.

SMBus is a trademark of Intel Corp.

# MAX9879 Evaluation Kit

Evaluates: MAX9879

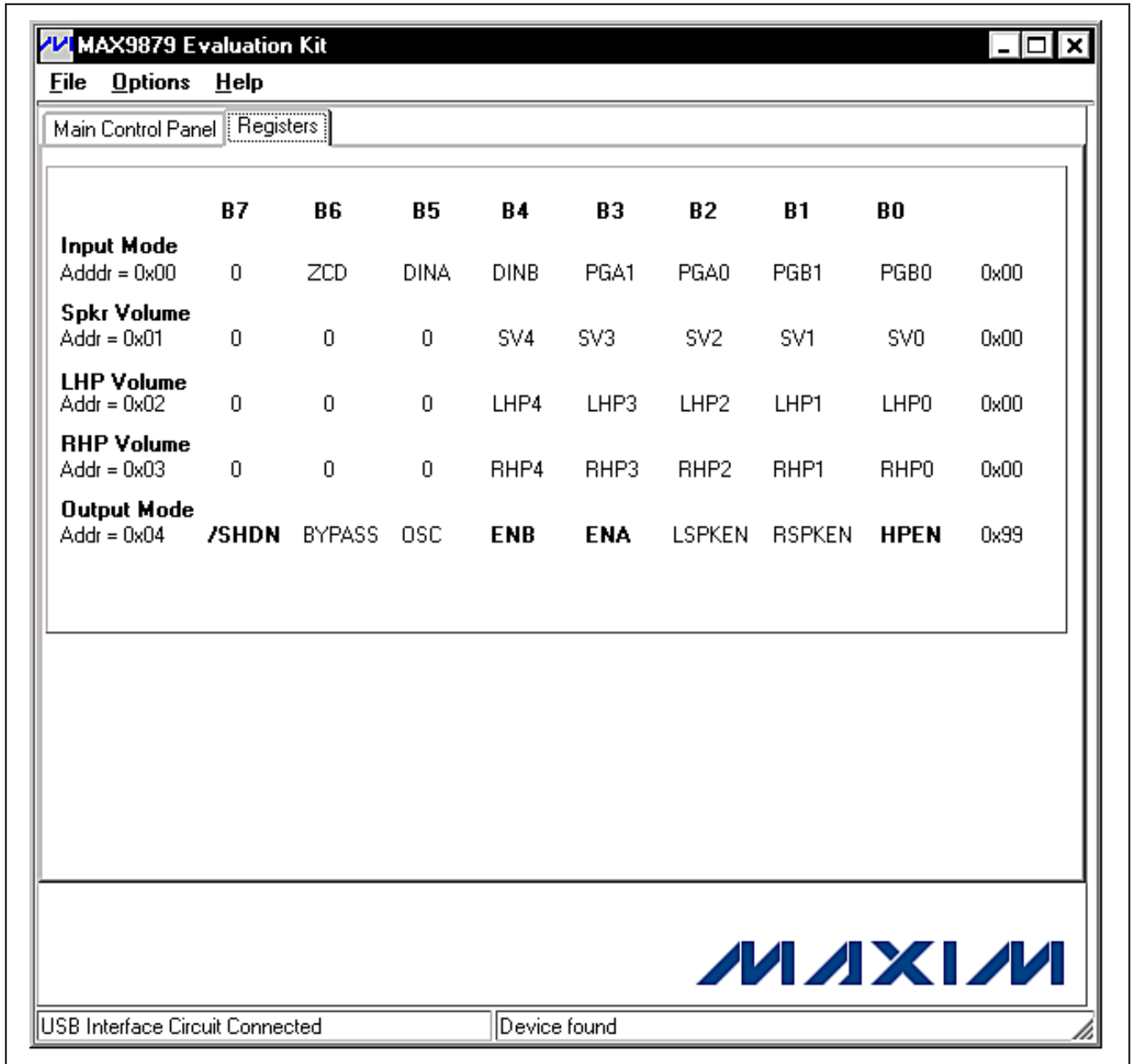

Figure 2. MAX9879 EV Kit Software Main Window (Registers Tab)

# MAX9879 Evaluation Kit

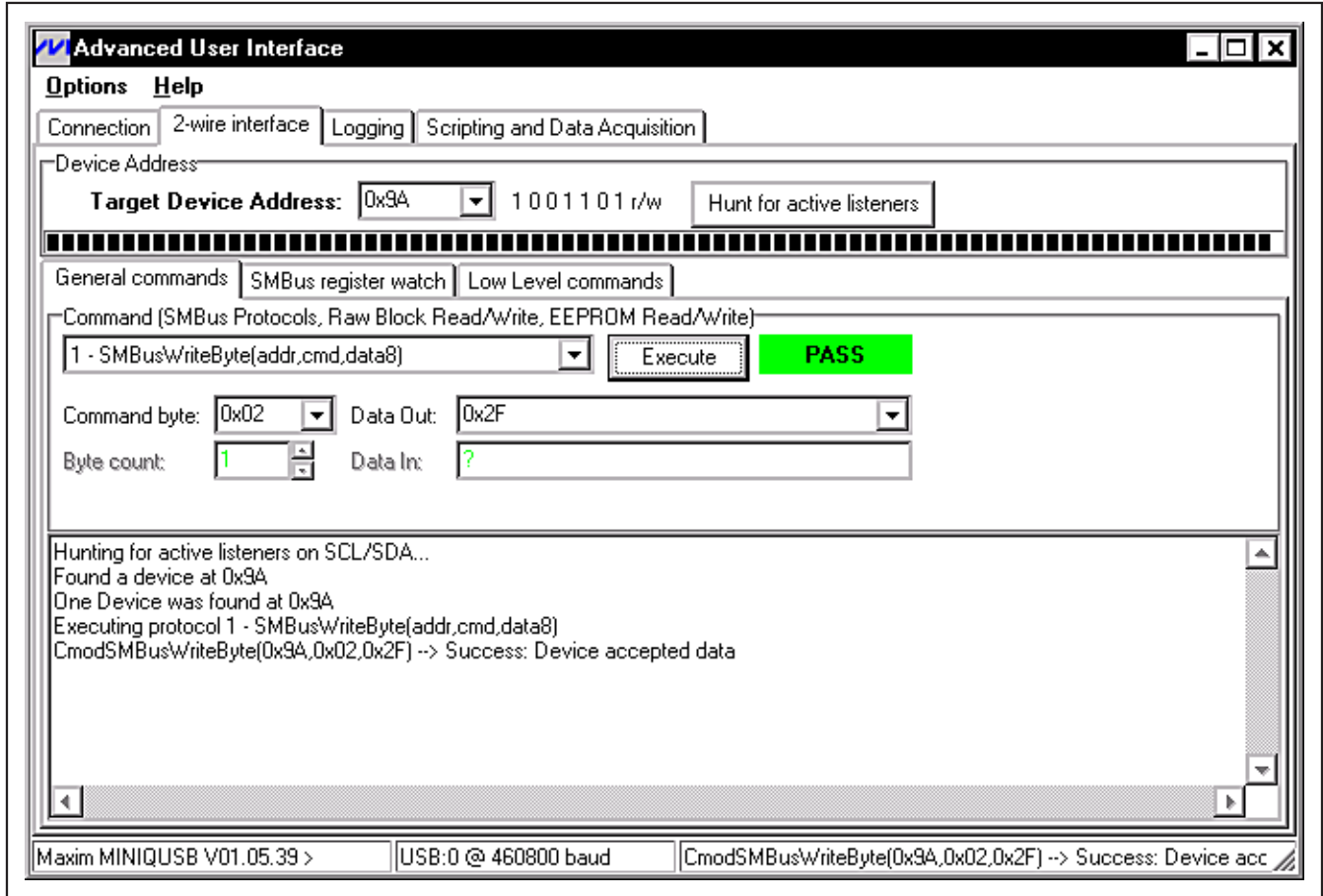

Figure 3. Example of a Simple SMBusWriteByte Operation Using the Advanced User Interface

### Filtered Output

Audio analyzers typically cannot accept pulse-width-modulated (PWM) signals at their inputs. Therefore, the MAX9879 EV kit features two pair of lowpass filters at the output to ease evaluation. To use the filtering output pads (FOUT<sub>+</sub> and FOUT<sub>-</sub>), install the inductors (L1–L4) provided separately with the EV kit. Then connect the load between FOUT<sub>+</sub> and FOUT<sub>-</sub>. Lastly, connect the filtered output to the audio analyzer. The default lowpass filters at the EV kit output are optimized for an 8Ω speaker.

### Output Filtering Requirements

- To ease evaluation, the MAX9879 EV kits are shipped with inductor-based output filters, with inductors L1–L4 provided separately with the EV kit. However, ferrite-bead filters (FB6, FB7, FB11, FB12, C32, C33, C48, and C49) should be used when EMC testing.
- The ferrite-bead filter component selections are dependent on speaker-wire length, and are determined during EMC testing.
- To install the ferrite-bead filters, first cut open the PCB traces between FB6, FB7, FB11, and FB12. Then install the ferrite-bead filtering components (FB6, FB7, C32, C33, C48, and C49). The speaker wires should be connected to the OUT<sub>+</sub> and OUT<sub>-</sub> test points using twisted-pair cables.



# MAX9879 Evaluation Kit

Evaluates: MAX9879

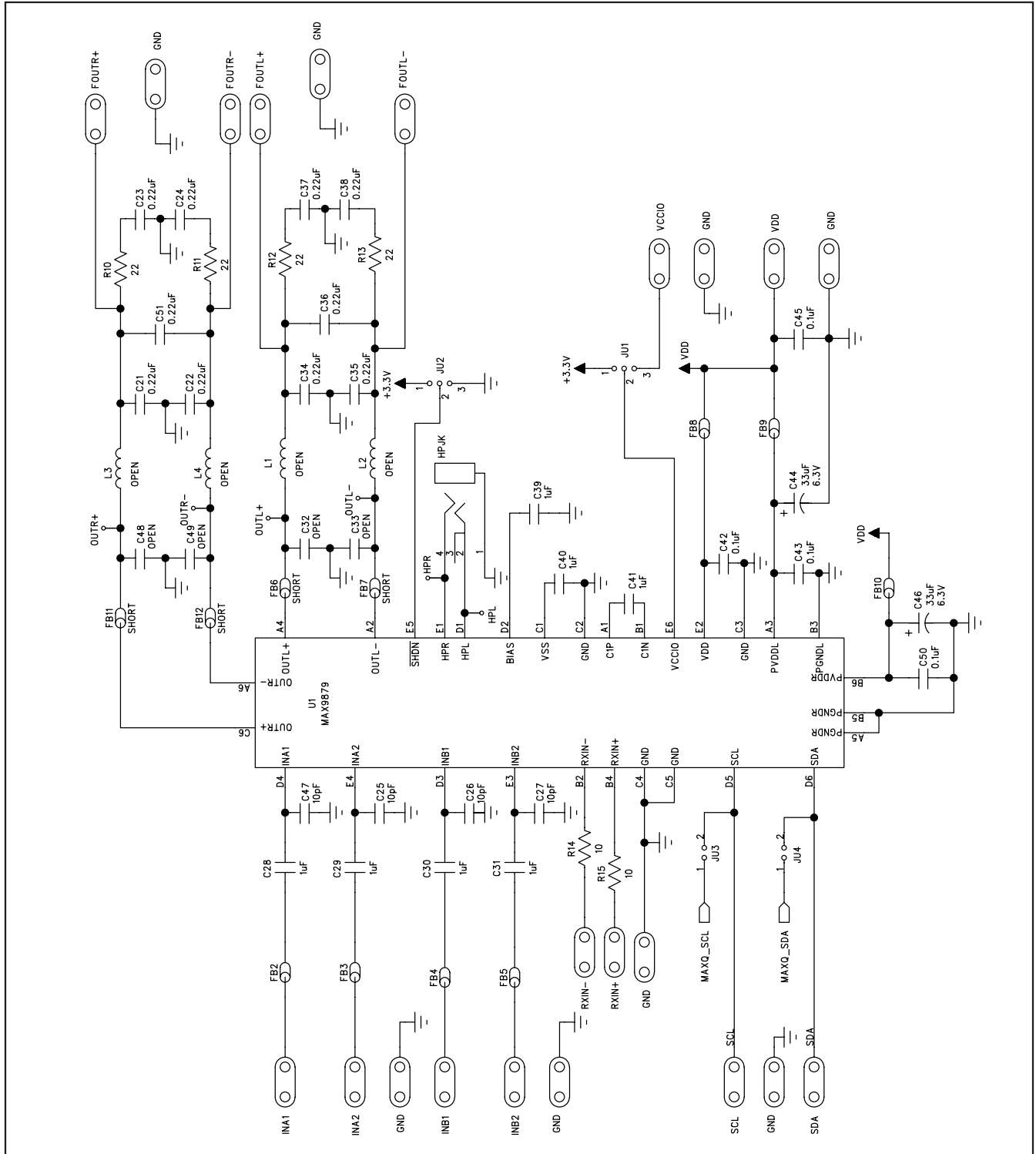

Figure 4a. MAX9879 EV Kit Schematic (Sheet 1 of 2)



# MAX9879 Evaluation Kit

Evaluates: MAX9879

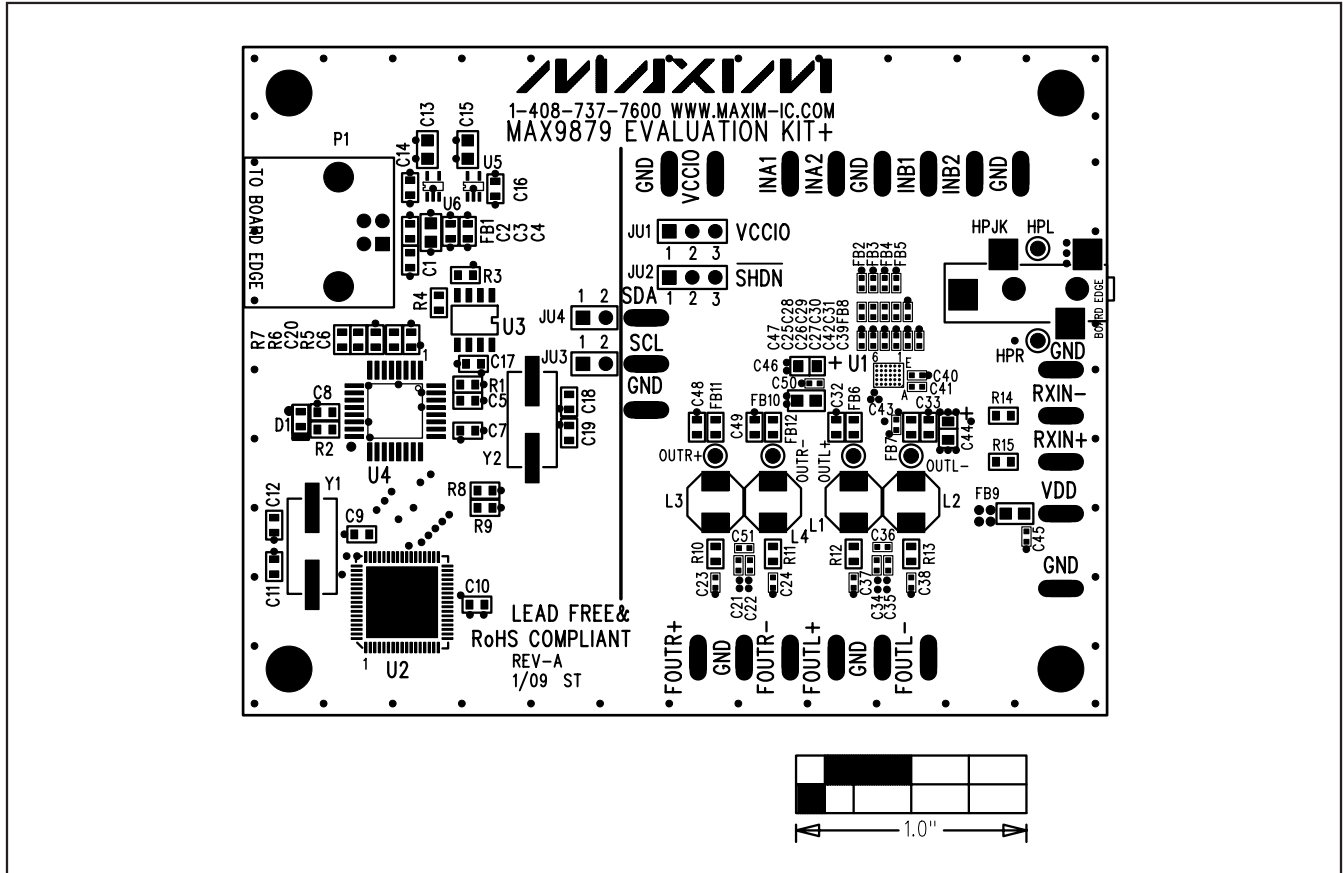

Figure 5. MAX9879 EV Kit Component Placement Guide—Component Side

# MAX9879 Evaluation Kit

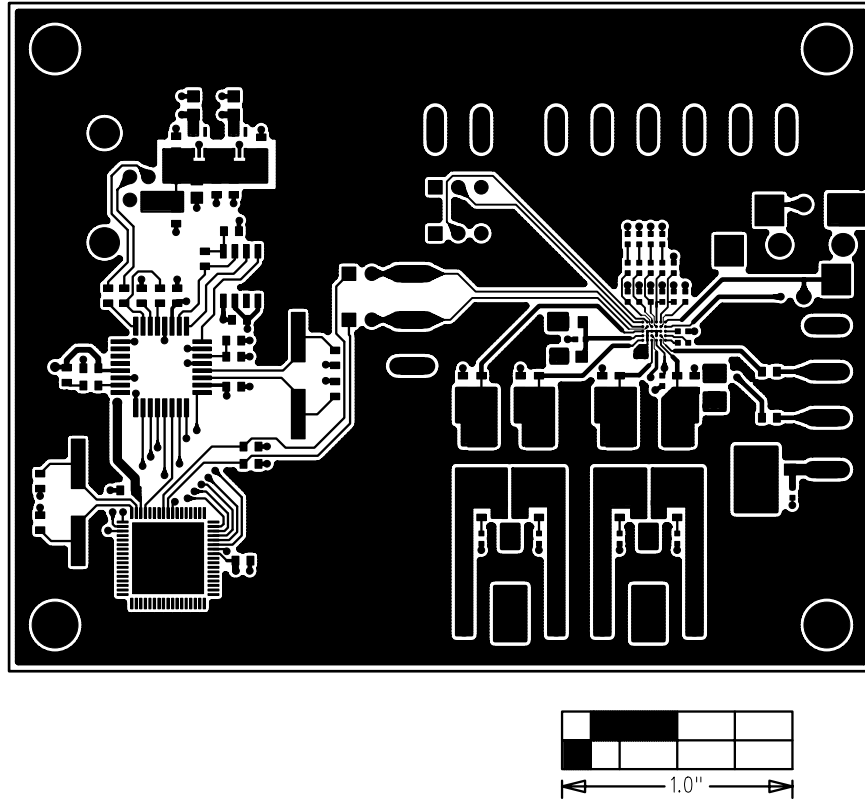

Figure 6. MAX9879 EV Kit Component PCB Layout—Component Side

# MAX9879 Evaluation Kit

Evaluates: MAX9879

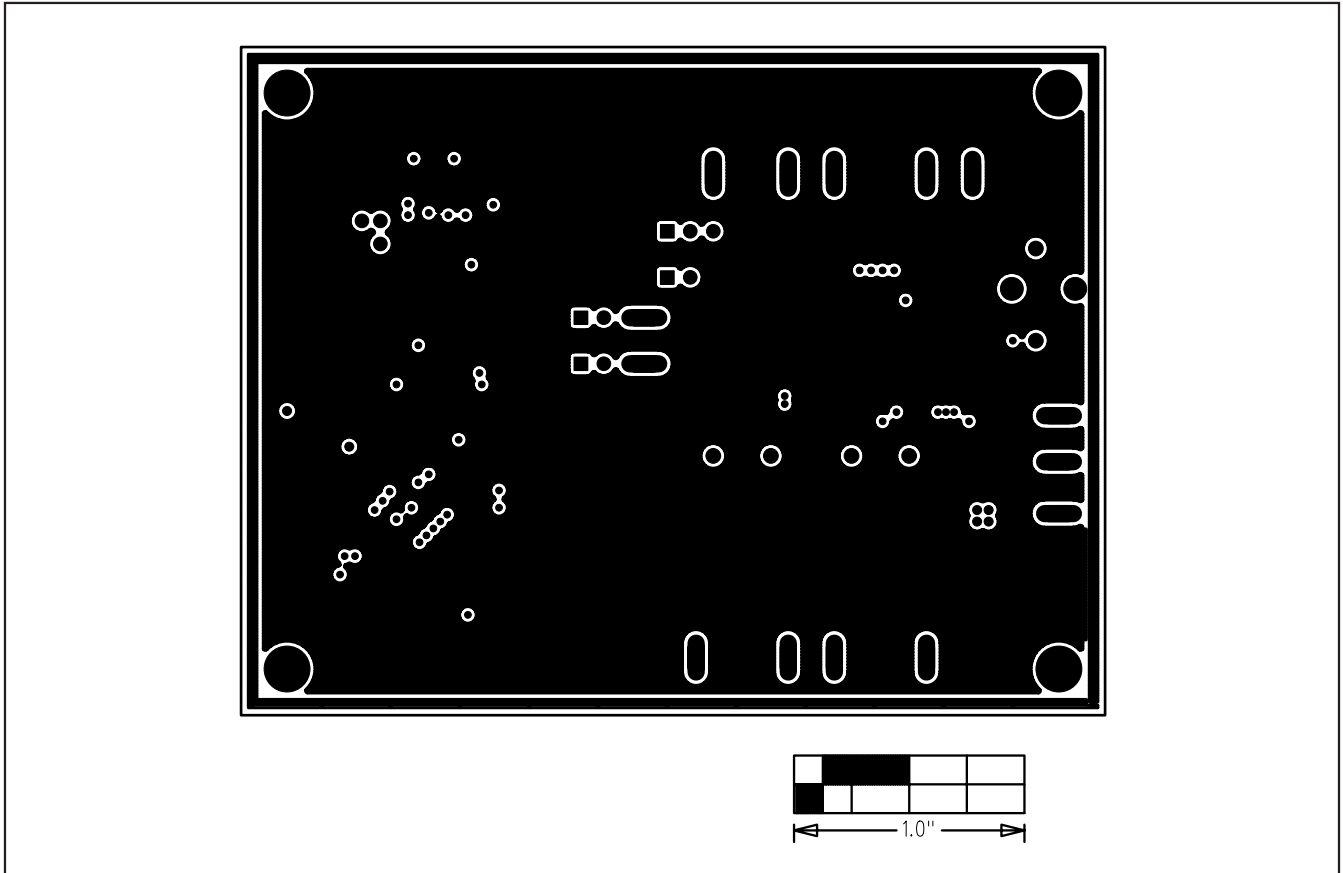

Figure 7. MAX9879 EV Kit PCB Layout—Inner Layer 2

# MAX9879 Evaluation Kit

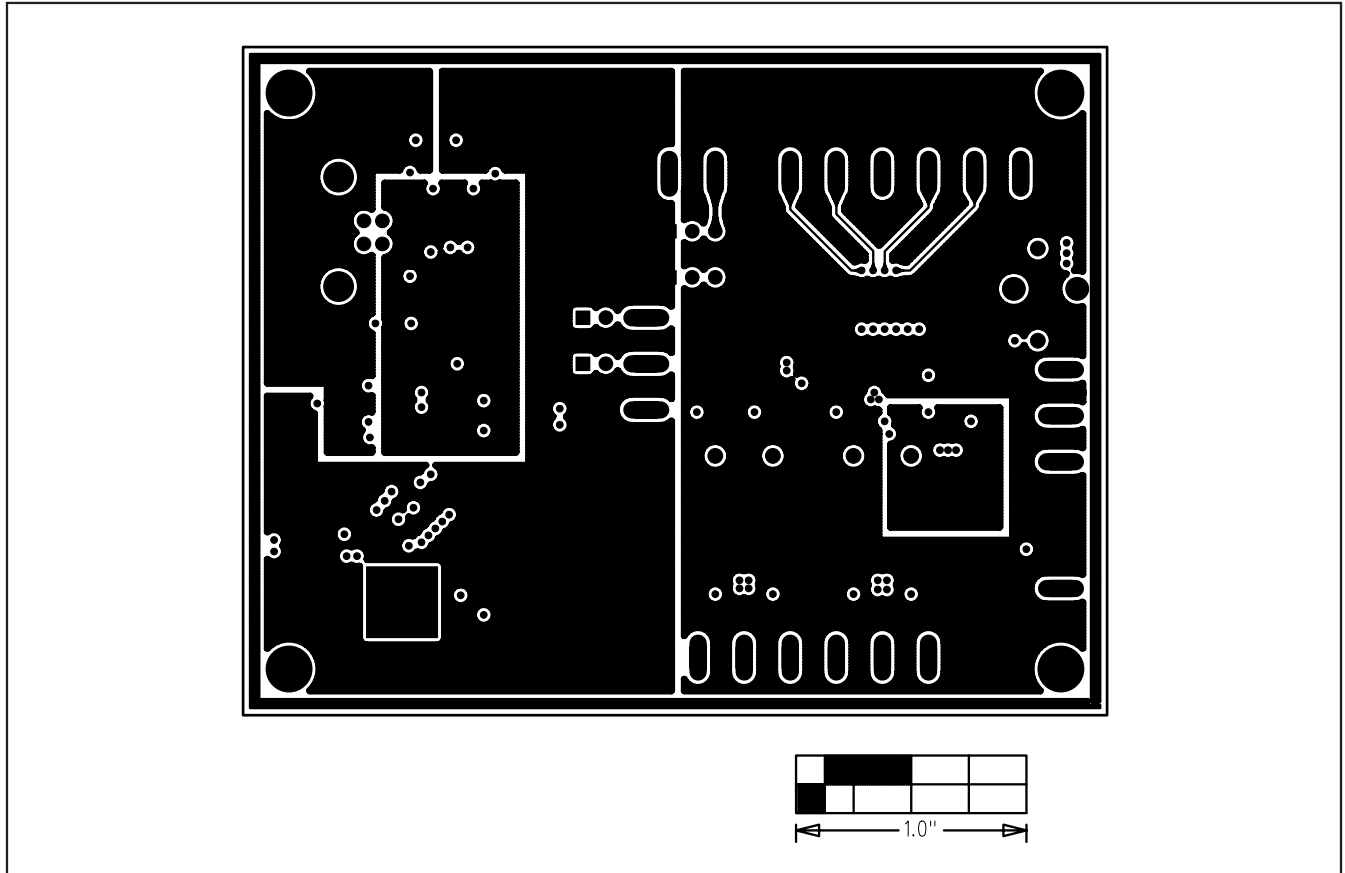

Figure 8. MAX9879 EV Kit PCB Layout—Inner Layer 3

# MAX9879 Evaluation Kit

Evaluates: MAX9879

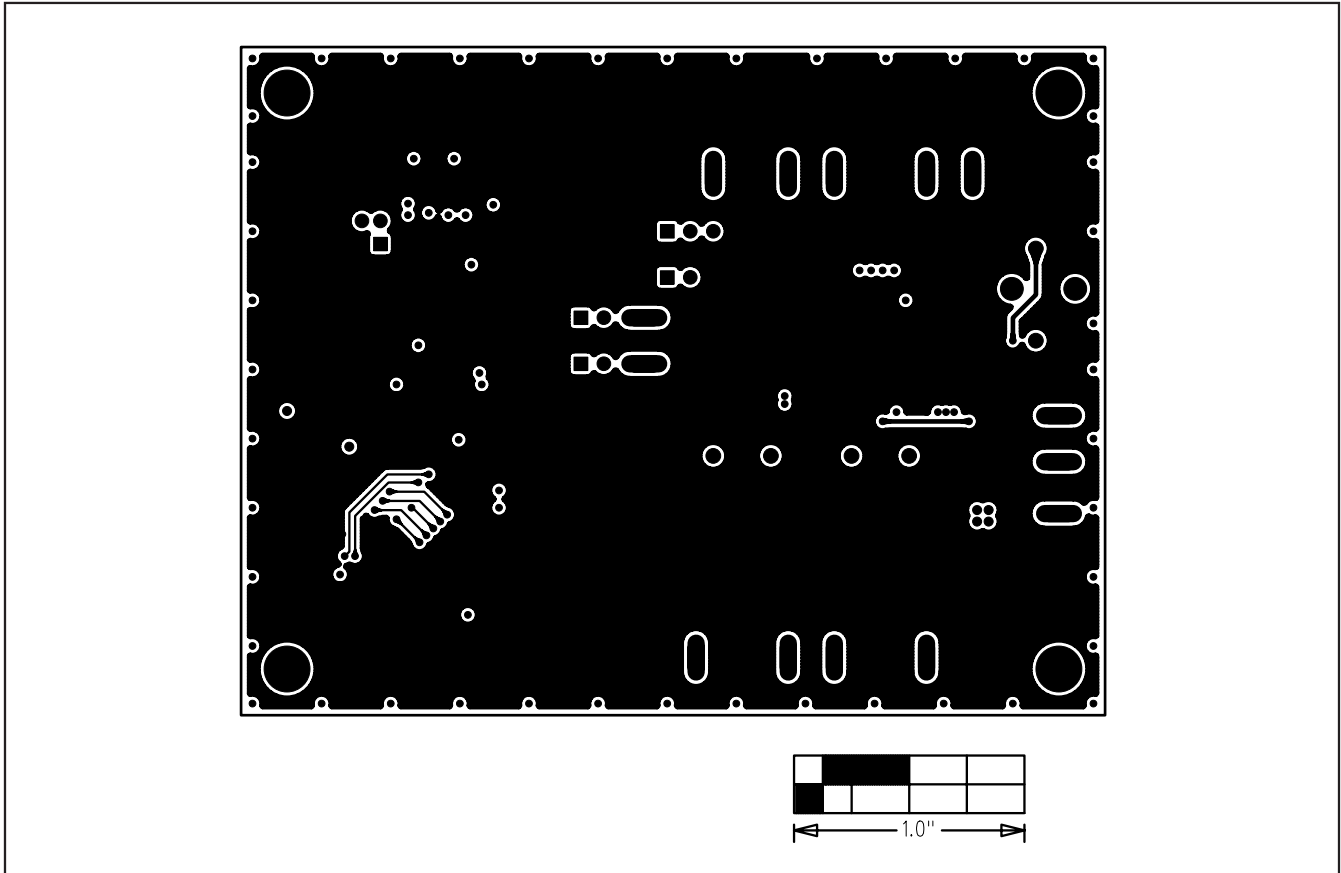

Figure 9. MAX9879 EV Kit PCB Layout—Solder Side

Maxim cannot assume responsibility for use of any circuitry other than circuitry entirely embodied in a Maxim product. No circuit patent licenses are implied. Maxim reserves the right to change the circuitry and specifications without notice at any time.

Maxim Integrated Products, 120 San Gabriel Drive, Sunnyvale, CA 94086 408-737-7600 \_\_\_\_\_ 15