

MAXIM

MAX9382 Evaluation Kit

General Description

The MAX9382 evaluation kit (EV kit) includes the MAX9382, a high-speed PECL/ECL phase-frequency detector. The EV kit evaluates the MAX9382, which compares single-ended reference (R) and VCO (V) inputs and produces pulse streams on differential up (U) and down (D) outputs, depending on the input phase or frequency difference. The EV kit operates up to 450MHz.

The MAX9382 EV kit is designed with 50Ω controlled-impedance traces in a four-layer PC board. The EV kit can also be used to evaluate the MAX9383.

Features

- ◆ Controlled 50Ω Microstrip Traces
- ◆ Equal Input Trace Lengths
- ◆ Output Trace Lengths Matched to <2mils
- ◆ Board Frequency: Up to 450MHz
- ◆ PECL/ECL Supply
- ◆ 8-Pin SO Package
- ◆ Fully Assembled and Tested

Ordering Information

PART	TEMP RANGE	IC PACKAGE
MAX9382EVKIT	0°C to +70°C	8 SO

Note: To evaluate the MAX9383, request a MAX9383ESA free sample with the MAX9382EVKIT.

Component List

DESIGNATION	QTY	DESCRIPTION
C1, C2	2	10μF ±10%, 10V tantalum capacitors (B case) AVX TAJB106K010R or Kemet T494B106K010AS
C3, C4	2	0.1μF ±10%, 16V X7R ceramic chip capacitors (0603) Taiyo Yuden EMK107BJ104KA or Murata GRM39X7R104K016A
C5, C6	2	0.01μF ±10%, 16V X7R ceramic capacitors (0402) Taiyo Yuden EMK105BJ103KW or Murata GRM36X7R103K016AD

DESIGNATION	QTY	DESCRIPTION
R1, R3	2	49.9Ω ±1% resistors (0402)
R2, R4	0	Not installed, resistor (0402)
R5–R8	4	100Ω ±0.1%, 1/4W resistors (0805) IRC PFC-W0805R-03-1000-B
R, V, U, \bar{U} , D, \bar{D}	6	SMA edge-mount connectors Johnson Components 142-0701-801
U1	1	MAX9382ESA (8-pin SO)
None	1	MAX9382 PC board
None	1	MAX9382 EV kit data sheet
None	1	MAX9382 data sheet

Component Suppliers

SUPPLIER	PHONE	FAX	WEBSITE
AVX	843-946-0238	843-626-3123	www.avxcorp.com
IRC	361-992-7900	361-992-3377	www.ircct.com
Kemet	864-963-6300	864-963-6322	www.kemet.com
Murata	770-436-1300	770-436-3030	www.murata.com
Taiyo Yuden	800-348-2496	847-925-0899	www.t-yuden.com

Note: Please indicate that you are using the MAX9382/MAX9383 when contacting these component suppliers.

MAX9382 Evaluation Kit

Quick Start

The MAX9382 EV kit is fully assembled and tested. **Do not turn on the power supplies until all connections are completed.**

Recommended Equipment

- One 450MHz (min) two-channel pulse generator (e.g., Agilent 8133A)
- One 12GHz (min) bandwidth oscilloscope with internal 50Ω input termination (e.g., Tektronix 1180IC digital sampling oscilloscope with SD-24 sampling head)
- Two power supplies
 - a) One 2.0V with 500mA current capability
 - b) One adjustable -3.5V to -2.2V with 500mA current capability
- Matched male-SMA-to-male-SMA 50Ω coax cables
 - a) Matched SMA 50Ω coax cables for inputs R and V
 - b) Matched SMA 50Ω coax cables for outputs U and D

Evaluating the MAX9382 at the Same Frequency with Different Phase

- 1) Connect two matched coax cables to the oscilloscope. Connect the other end of the cables to U and D on the EV kit board.

- 2) Connect a 2.0V power supply to the VCC pad. Set the supply to 2.00V. Connect the supply ground to the GND pad closest to VCC.
- 3) Connect a -2.5V adjustable power supply to the pad labeled VEE. Set the supply to -2.5V. Connect the supply ground to the GND pad closest to VEE.
- 4) Connect one pair of matched coax cables to the pulse generator's noninverting outputs. Connect the other end of the cables to R and V on the EV kit.
- 5) Adjust the signal generator to the following settings:
 - a) $V_{IH} = 1.0V$
 - b) $V_{IL} = 0.4V$
 - c) Duty cycle = 50%
 - d) Frequency = 450MHz
 - e) Set R lagging V = 600ps
- 6) Turn on the power supplies, enable the generator, and verify that the output signals meet the following specifications:
 - a) $V_{OH}: 965mV < V_{OH} < 1.12V$
 - b) $V_{OL}: 190mV < V_{OL} < 380mV$

The U and D waveforms should be similar to Figure 1.

Note: For other input levels, refer to the MAX9382/MAX9383 data sheet, setting $V_{CC} = 2.0V$.

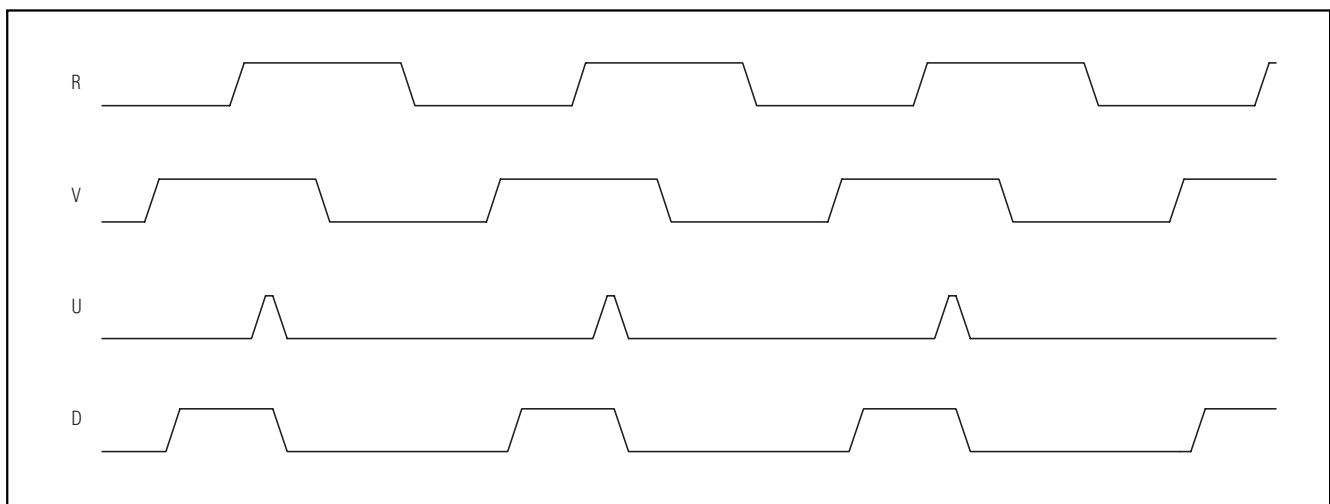

Figure 1. Waveform for R Lagging V

MAX9382 Evaluation Kit

Detailed Description

The MAX9382 EV kit contains the MAX9382, a high-speed PECL/ECL phase-frequency detector. The EV kit compares two single-ended inputs, R (reference) and V (VCO), and produces pulse streams on differential up (U) and down (D) outputs. When integrated, the difference of the output pulse streams provides a control voltage proportional to the input phase or frequency difference.

Power Supply

In order to terminate the outputs with 50Ω to $(V_{CC} - 2\text{ V})$ using the 50Ω oscilloscope input termination, V_{CC} is set to 2.0V. In an actual application, V_{CC} and V_{EE} can have different supplies (refer to the MAX9382/MAX9383 data sheet).

Evaluating the MAX9383

The MAX9382 EV kit can be used to evaluate the MAX9383, a high-speed phase-frequency detector with a supply range different from the MAX9382. To evaluate the MAX9383, replace the MAX9382ESA with a MAX9383ESA. Table 1 shows the V_{EE} ranges for the MAX9382 and MAX9383 when used with the MAX9382 EV kit.

Table 1. V_{EE} Ranges

DEVICE	V_{EE} RANGE (V)
MAX9382	-3.5 to -2.2
MAX9383	-3.5 to -2.75

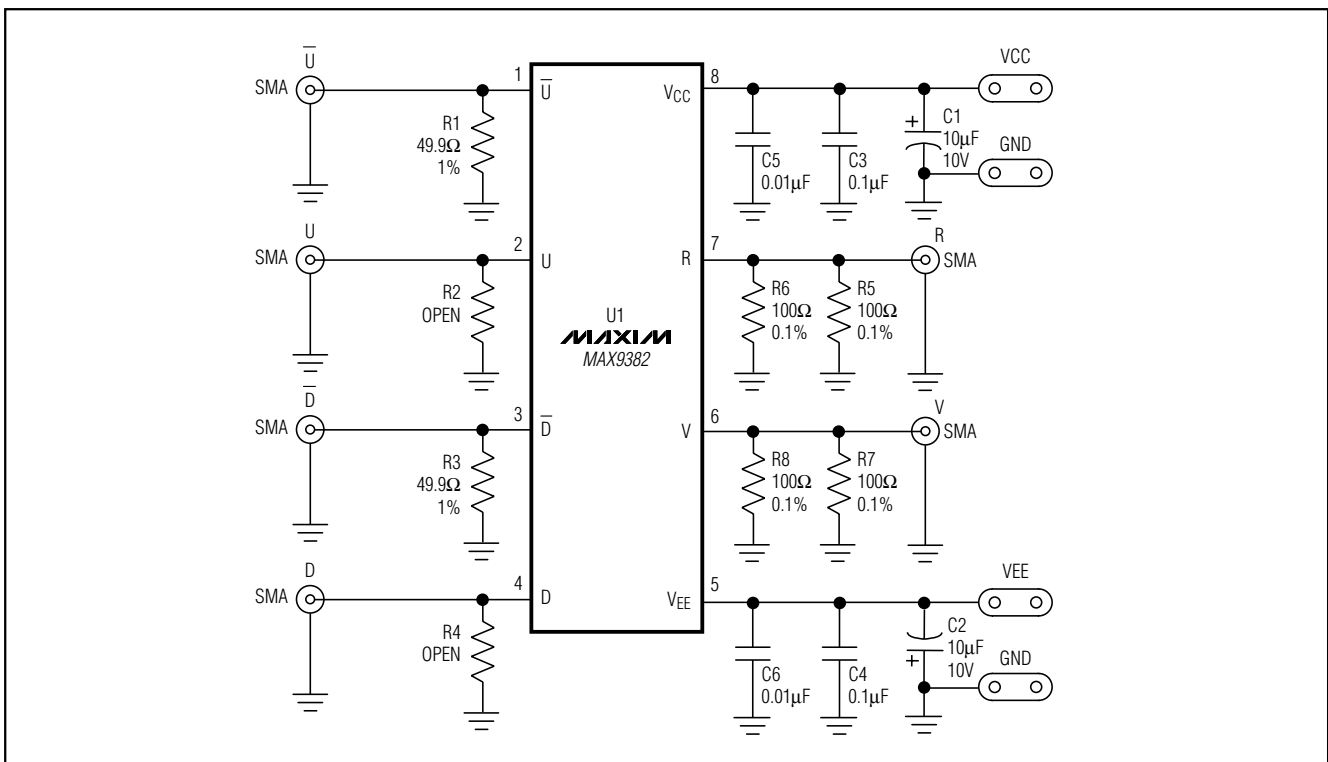

Figure 2. MAX9382 EV Kit Schematic

Evaluates: MAX9382/MAX9383

MAX9382 Evaluation Kit

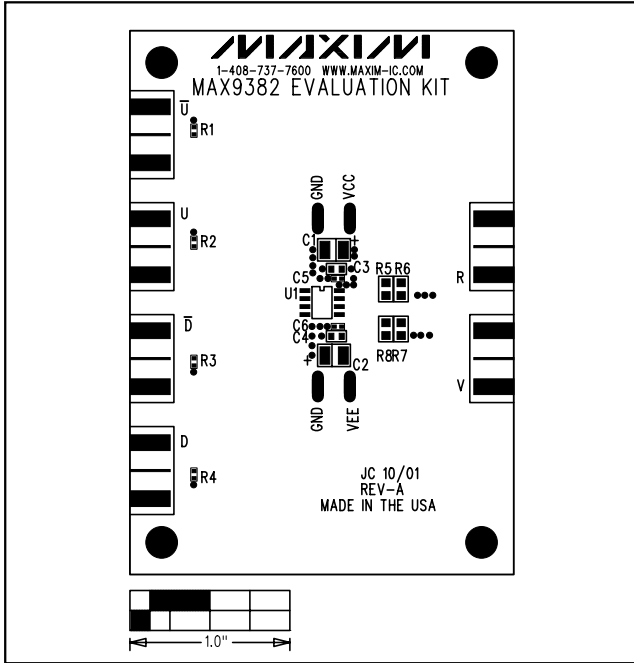

Figure 3. MAX9382 EV Kit Component Placement Guide—Component Side

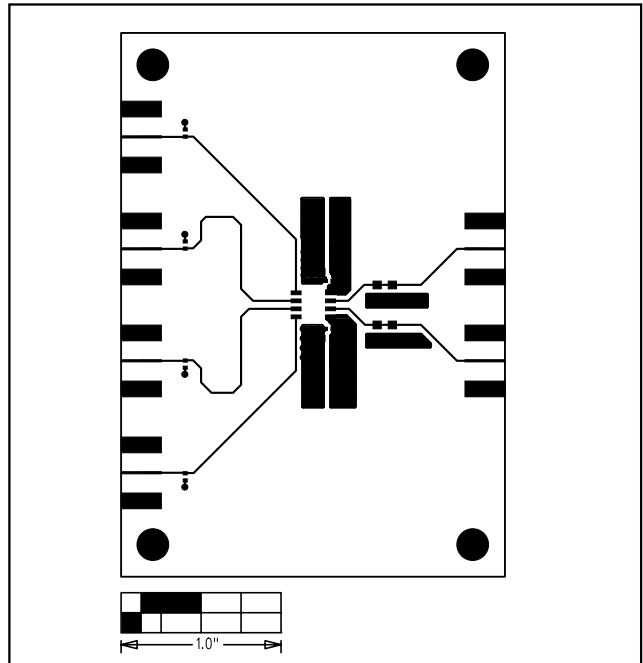

Figure 4. MAX9382 EV Kit PC Board Layout—Component Side

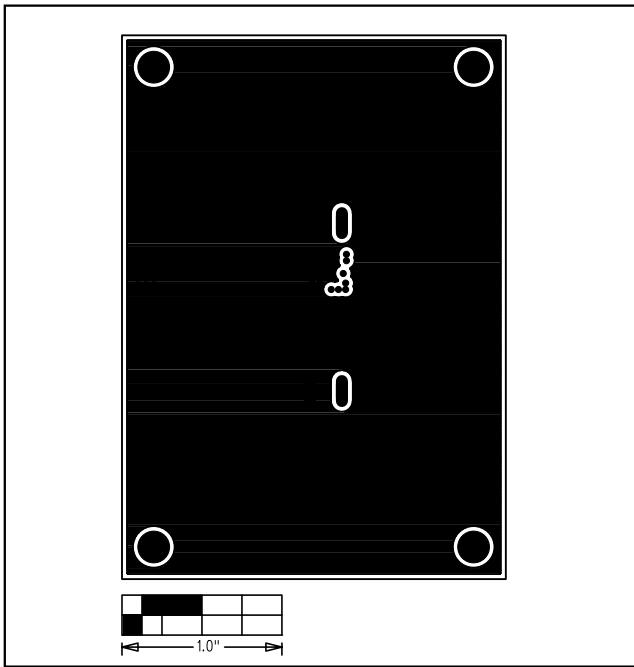

Figure 5. MAX9382 EV Kit PC Board Layout—Inner Layer 2 (GND Layer)

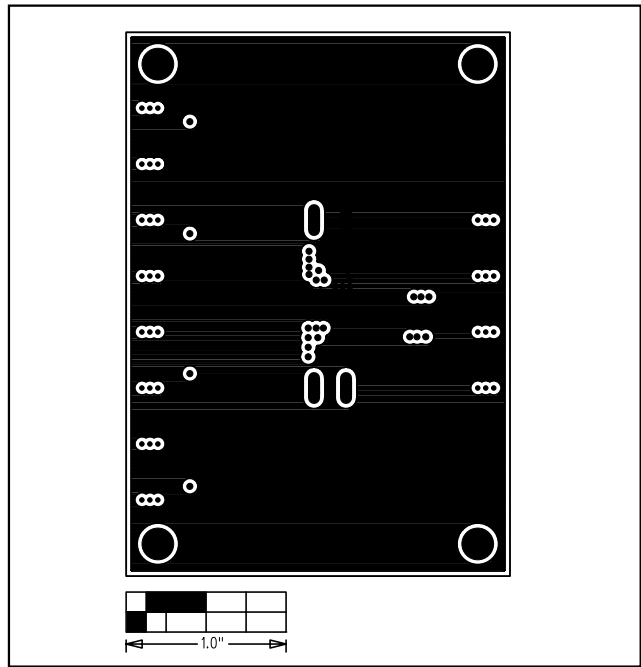

Figure 6. MAX9382 EV Kit PC Board Layout—Inner Layer 3 (VCC Layer)

MAX9382 Evaluation Kit

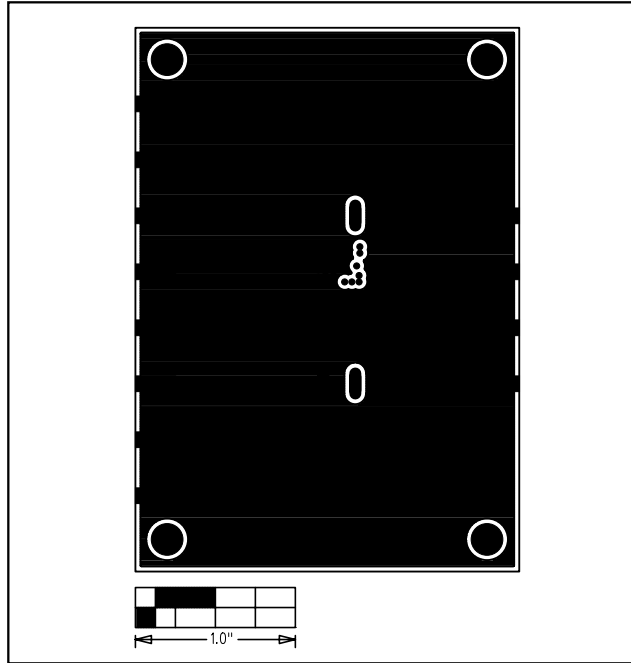

Figure 7. MAX9382 EV Kit PC Board Layout—Solder Side

Maxim cannot assume responsibility for use of any circuitry other than circuitry entirely embodied in a Maxim product. No circuit patent licenses are implied. Maxim reserves the right to change the circuitry and specifications without notice at any time.

5 _____ **Maxim Integrated Products, 120 San Gabriel Drive, Sunnyvale, CA 94086 408-737-7600**