



MAX6964 Evaluation Kit/Evaluation System

General Description

The MAX6964 evaluation kit (EV kit) is a fully assembled and tested surface-mount, 17-output LED driver/GPO controller printed-circuit board (PCB). The circuit uses a MAX6964 IC in a 24-pin QSOP package. The EV kit includes four RGB LEDs and five white LEDs that can be controlled simultaneously by the MAX6964. The EV kit demonstrates the MAX6964 IC's 8-bit PWM LED intensity control, two-phase LED blinking, reset, and unique single-pin, one-of-four I²C or 2-wire address features.

The MAX6964 EV kit also demonstrates the BLINK feature and includes a configurable oscillator circuit. The EV kit can also be reconfigured for evaluating a relay.

The MAX6964 EV kit provides PCB pads for the MAX6964 2-wire serial-interface signals. A CMAXQUSB interface board can be used to enable PC communication through the 2-wire serial interface. Windows 98SE/2000/XP[®]-compatible GUI software is provided to access the MAX6964 IC. The MAX6964 EV kit can also be interfaced directly to a user-provided 2-wire system.

Order the MAX6964EVCMAXQUSB+ for a complete PC-based evaluation of the MAX6964. Order the MAX6964EVKIT+ if you already have a CMAXQUSB interface board or do not require PC-based evaluation of the MAX6964.

Windows is a registered trademark of Microsoft Corp.

Features

- ◆ Proven PCB Layout
- ◆ Evaluates Four RGB and Five White LEDs
- ◆ Independent Output Control of Each LED
- ◆ Demonstrates Unique Single-Pin, One-of-Four 2-Wire Addressing
- ◆ Demonstrates Relay Driving
- ◆ PC Interface or User 2-Wire System Interface
- ◆ Windows 98SE/2000/XP-Compatible Software
- ◆ Surface-Mount Components
- ◆ Fully Assembled and Tested

Ordering Information

PART	TEMP RANGE	IC PACKAGE	2-WIRE SERIAL INTERFACE TYPE
MAX6964EVKIT+	0°C to +70°C	24 QSOP	User supplied
MAX6964EVCMAXQUSB+	0°C to +70°C	24 QSOP	CMAXQUSB

+Denotes lead-free and RoHS-compliant.

Note: The MAX6964 EV kit software can be downloaded from www.maxim-ic.com/evkitsoftware. However, the CMAXQUSB interface board is required to interface the EV kit to a computer when using the software.

Component Lists

MAX6964 EV System

PART	QTY	DESCRIPTION
MAX6964EVKIT+	1	MAX6964 evaluation kit
CMAXQUSB+	1	2-wire serial-interface board

MAX6964 EV KIT

DESIGNATION	QTY	DESCRIPTION
C1	1	47µF, 10V low-ESR POSCAP (C) SANYO 10TPB47MC
C2	1	1µF ±10%, 6.3V X5R ceramic capacitor (0603) AVX 06036D105KA or Taiyo Yuden JMK107BJ105KA
C3	1	4.7µF ±10%, 6.3V X5R ceramic capacitor (0805) AVX 08056D475KA or Taiyo Yuden JMK212BJ175KG

DESIGNATION	QTY	DESCRIPTION
C4, C6	2	0.1µF ±10%, 16V X7R ceramic capacitors (0603) Murata GRM188R71C104K
C5	1	10µF ±20%, 6.3V X5R ceramic capacitor (0603) TDK C1608X5R0J106M
D1-D4	4	RGB LEDs (2.8mm x 3.2mm) SML-LX2832SISUGSBC
D5-D9	5	White LEDs (PLCC-2) OPTEK OVS9WBCR4
J1	1	2 x 10 right-angle female receptacle
JU1, JU3	2	3-pin headers
JU2	1	5-pin header
JU4, JU5	2	2-pin headers
JU6, JU7	0	Not installed, 2-pin headers



MAX6964 Evaluation Kit/Evaluation System

Component Lists (continued)

DESIGNATION	QTY	DESCRIPTION
R1–R5	5	110Ω ±5% resistors (0603)
R6, R9, R12, R15	4	68Ω ±5% resistors (0603)
R7, R10, R13, R16	4	120Ω ±5% resistors (0603)
R8, R11, R14, R17	4	130Ω ±5% resistors (0603)
R18, R19	2	165kΩ ±1% resistors (0603)
R20	1	82.5kΩ ±1% resistor (0603)
R21	1	10kΩ ±5% resistor (0603)
SW1	1	SPST momentary contact switch
U1	1	Maxim 17-output LED driver/GPO MAX6964AEG (24-pin QSOP)
U2, U3	2	TinyLogic HS inverter with Schmitt trigger input (SC70-5) Fairchild NC7S14P5X
—	5	Shunts (JU1–JU5)
—	1	PCB: MAX6964 Evaluation Kit+

MAX6964 EV Kit Files

FILE	DESCRIPTION
INSTALL.EXE	Installs the EV kit files on your computer
MAX6964.EXE	Application program
FTD2XX.INF	USB device driver file
UNINST.INI	Uninstalls the EV kit software
TROUBLESHOOTING_USB.PDF	USB driver installation help file

Component Suppliers

SUPPLIER	PHONE	WEBSITE
AVX Corp.	843-946-0238	www.avxcorp.com
Fairchild Semiconductor	888-522-5372	www.fairchildsemi.com
Murata Mfg. Co., Ltd.	770-436-1300	www.murata.com
OPTEK Technologies	972-323-2200	www.optekinc.com
SANYO Electronic Device	619-661-6835	www.sanyodevice.com
Taiyo Yuden	800-348-2496	www.t-yuden.com
TDK	847-803-6100	www.component.tdk.com

Note: Indicate that you are using the MAX6964 when contacting these component suppliers.

Quick Start

Required Equipment

- 5V, 0.5A-rated DC power supply
- Maxim MAX6964 EV kit and CMAXQUSB interface board
- Windows 98SE/2000/XP-compatible PC with a spare USB port
- USB I/O extension cable, straight-through, male-to-female cable

Note: In the following sections, software-related items are identified by bolding. Text in **bold** refers to items directly from the EV kit software. Text in **bold and underlined** refers to items from the Windows 98SE/2000/XP operating system.

MAX6964 Software and Hardware Configuration

The MAX6964 EV kit is fully assembled and tested. Follow the steps below to verify board operation. **Caution: Do not turn on the power supply until all connections are completed.**

- 1) Visit www.maxim-ic.com/evkitsoftware to download the latest version of the EV kit software, 6964Rxx.ZIP. Save the EV kit software to a temporary folder and uncompress the ZIP file.
- 2) Install the EV kit software on your computer by running the INSTALL.EXE program inside the temporary folder. The program files are copied and icons are created in the Windows **Start | Programs** menu.
- 3) Verify that a shunt is installed on the 3.3V pins of jumper JU1 (VDD SELECT) on the CMAXQUSB interface board. This process configures the CMAXQUSB interface board VDD SELECT supply to 3.3V.
- 4) Verify that a shunt is installed on pins 2-3 of jumper JU1 (CMAXQUSB V_{DD} supplies V₊) on the MAX6964 EV kit.
- 5) Verify that a shunt is installed on pins 1-3 of jumper JU2 (0x40 address).
- 6) Verify that a shunt is installed on pins 2-3 of jumper JU3 (OSC signal).
- 7) Verify that a shunt is installed on jumpers JU4 and JU5 (3Hz blink rate).
- 8) Utilizing short leads, connect the 5V power supply to the EV kit's VLED PCB pad. Utilizing short leads, connect the power-supply ground to the EV kit's GND PCB pad near the VLED pad.
- 9) Connect the CMAXQUSB interface board to the MAX6964 EV kit's J1 connector.

MAX6964 Evaluation Kit/Evaluation System

Evaluate: MAX6964

- 10 Set both CMAXQUSB interface board SW1 switches to the ON position. These components provide pullup resistors for the SDA and SCL 2-wire bus signals.
- 11) Turn on the 5V power supply. The CMAXQUSB interface board is powered through the computer's USB port.
- 12) Connect the included USB cable from the PC to the CMAXQUSB interface board. A **Building Driver Database** window pops up in addition to a **New Hardware Found** message. If you do not see any window that is similar to the one described above after 30 seconds, remove the USB cable from the CMAXQUSB interface board and reconnect it again. Administrator privileges are required to install the USB device driver on Windows 2000/XP.
- 13) Follow the directions of the **Add New Hardware Wizard** to install the USB device driver. Choose the **Search for the best driver for your device** option. Specify the location of the device driver as **C:\Program Files\MAX6964** by using the **Browse** button. Refer to the TROUBLESHOOTING USB.PDF document included with the software for more information.
- 14) Start the MAX6964 program by opening its icon in the **Start|Programs** menu.
- 15) The software detects the CMAXQUSB interface board and the MAX6964 IC 2-wire address, then updates the screen. The EV kit and software are then ready for further evaluation.

See the *Detailed Software Description* section in this document for more information on the software GUI features.

Detailed Hardware Description

The MAX6964 EV kit demonstrates the MAX6964 17-output LED driver/GPO controller's features. The EV kit's circuit uses a MAX6964 IC in a 24-pin QSOP package on a proven PCB layout design. The EV kit features four RGB LEDs, five white LEDs, a relay interface (JU7) and a configurable BLINK oscillator. The LEDs can be controlled independently and their intensity varied using the appropriate MAX6964 8-bit PWM control register. The MAX6964 IC's two-phase feature and unique single-pin, one-of-four 2-wire address feature can also be evaluated with the EV kit. The MAX6964 IC requires 3.3V for operation and is powered by the EV kit circuit's V+ rail.

The MAX6964 IC's blink feature is demonstrated by using a configurable oscillator circuit. The oscillator circuit comprises two logic inverters (U2 and U3), a

capacitor (C5), and resistors (R18, R19, and R20). By configuring jumpers JU4 and JU5, 0.7Hz to 3.0Hz BLINK frequencies can be evaluated. PCB pads are also provided for connecting an external square-wave oscillator to the BLINK_IN pads. Jumper JU6 can be used to disable and power down both inverters, U2 and U3, hence disabling the oscillator.

The EV kit circuit can also be reconfigured for evaluating a 5V-rated relay by using jumper JU7 pads. White LED D5 and resistor R5 must be removed and a short placed across resistor R5 pads. The MAX6964 can sink up to 50mA on the output.

The MAX6964 EV kit provides SCL and SDA PCB pads for the 2-wire serial-interface signals. These pads can be connected directly to a user-provided 2-wire system that has pullup resistors for the SCL and SDA signals. Alternatively, the EV kit can be used with a CMAXQUSB interface board for communicating with a PC through the 2-wire serial interface. Jumper JU2 is used to configure the MAX6964 IC's 2-wire address and demonstrates the IC's unique single-pin, one-of-four 2-wire address feature using the SCL or SDA signals for addressing. A PCB pad is also provided for the MAX6964 IC pin, AD0. See Table 2 for additional information.

Jumper and Switch Functions

Several jumper selections and a reset switch function provided by the MAX6964 EV kit are presented in the following tables.

EV Kit Circuit V+ Source

The MAX6964 EV kit features a jumper, JU1, to select the source for the V+ rails of the EV kit circuit. The circuit's V+ rail is typically supplied 3.3V by a CMAXQUSB interface board. Alternatively, the EV kit's VIN PCB pad can be used to supply 3.3V to the circuit's V+ rail. The CMAXQUSB interface board is powered through a PC's USB cable. Table 1 lists the various jumper options for powering the circuit's V+ rail.

Table 1. V+ Source (3.3V), JU1 Configuration

SHUNT POSITION	V+ PIN	EV KIT 3.3V SUPPLY SOURCE
1-2	Connected to VIN PCB pad	VIN PCB pad
2-3	Connected to VDD PCB pad	CMAXQUSB interface board or external supply*

*This configuration also allows the user to use an external supply for the VDD source to power the V+ pin of the MAX6964 IC.

MAX6964 Evaluation Kit/Evaluation System

MAX6964 2-Wire Serial Address

The MAX6964 EV kit features a jumper, JU2, for configuring the MAX6964 2-wire serial address. The SCL, SDA, and ADO PCB pads are provided for interfacing to the 2-wire serial address bus and configuring the address, respectively. Table 2 lists the various jumper options for configuring the 2-wire address.

BLINK Signal Source

The MAX6964 EV kit features a jumper to select the MAX6964 IC BLINK pin source, either the EV kit's oscillator (U2 and U3) or a user-provided CMOS square-wave signal. The square-wave signal is applied to the EV kit's BLINK_IN PCB pads. Table 3 lists the various jumper options for the signal source.

Oscillator Frequency Selection and Enable

The MAX6964 EV kit features jumpers JU4 and JU5 to set the EV kit's oscillator frequency. The oscillator frequency ranges from 0.7Hz to 3.0Hz. Additionally, jumper JU6 is provided to disable the EV kit's oscillator. Table 4 lists the various frequency selection options for jumper JU4. Table 5 lists jumper JU6 enable/disable options for inverters U2 and U3.

Reset Control Methods

The MAX6964 EV kit features a switch to reset the MAX6964 IC. Additionally, the EV kit provides a RST PCB pad for using an external controller to reset the MAX6964 IC. Refer to the MAX6964 IC data sheet for additional functions of the MAX6964 RST pin. Table 6 lists the various switch and alternate reset options for resetting the MAX6964 IC.

Table 2. 2-Wire Serial Address, JU2 Configuration

U1 ADDRESS	SHUNT POSITION	ADO PIN	EV KIT OPERATION
0x40	1-3	Connected to GND	MAX6964 2-wire address = 0x40
0x48	1-2	Connected to V+	MAX6964 2-wire address = 0x48
0xC0	1-4	Connected to SCL	MAX6964 2-wire address = 0xC0
0xC8	1-5	Connected to SDA	MAX6964 2-wire address = 0xC8
0x40, 0x48, 0xC0, 0xC8	Open*	Connected to ADO PCB pad	MAX6964 2-wire address set externally by user interface

*When using an external 2-wire serial interface, the shunt on jumper JU2 must be removed so the external 2-wire serial interface has control of the MAX6964 ADO pin.

Table 3. BLINK Source, JU3 Configuration

SHUNT POSITION	BLINK PIN	MAX6964 BLINK SOURCE
1-2	Connected to BLINK_IN PCB pad	External CMOS square-wave oscillator
2-3*	Connected to OSC	EV kit oscillator

*See Table 4 for configuring the oscillator frequency.

Table 4. Oscillator Frequency, JU4, JU5 Configuration

SHUNT POSITION		OSCILLATOR FREQUENCY (Hz)
JU4	JU5	
Open	Open	0.7
Installed	Open	1.5
Open	Installed	2.2
Installed	Installed	3.0

Table 5. Oscillator Enable, JU6 Configuration

PC TRACE SHORT	U2/U3 PIN 5	OSCILLATOR OPERATION
Installed*	Connected to V+	Enabled
Cut open	Open	Disabled, not powered

*Default configuration.

Table 6. Reset Switch and Control Option, SW1 Functions

SWITCH STATE	RST PIN CONNECTION	MAX6964 OPERATION
—	$\overline{\text{RST}}$ pin pulled high by R21	MAX6964 operating
Pressed	$\overline{\text{RST}}$ pin pulled low by SW1	Resetting MAX6964
—	—	—
—	$\overline{\text{RST}}$ pin pulled high by R21	MAX6964 operating
—	$\overline{\text{RST}}$ pin pulled low by external controller	External controller resets MAX6964

MAX6964 Evaluation Kit/Evaluation System

Evaluate: MAX6964

Detailed Software Description

Note: Words in boldface are user-selectable features in the MAX6964 EV kit software. A mouse or the keyboard's tab key is used to navigate various items on the main window.

The MAX6964 EV kit software features window tabs to select the **Global and White LED Config/Status** or **RGB LED Config/Status** window. A few more available software features can be evaluated by using the pull-down menu. The software has a demo mode that is available using the **View | Demo Mode** pulldown menu. When in demo mode, all software communication to the EV kit hardware is disabled and most of the software's GUI is functional. This feature enables a user to evaluate the software without hardware connectivity.

The MAX6964 EV kit software configures the CMAXQUSB interface board's 2-wire communication speed to 400kHz by default. The speed can be reduced to 100kHz, if required, by selecting the pulldown menu's **View | 2-Wire Speed | 100kHz** selection. This configuration may be required if slower 2-wire devices are connected to the

EV kit's SCL and SDA pads.

The left bottom status bar of the main window provides the CMAXQUSB interface board communication status. The right bottom status bar provides the current program status and 2-wire communication status with respect to the MAX6964 IC.

Software Startup

Upon starting the program, the MAX6964 EV kit software automatically detects the U1 serial address, configures the MAX6964 IC, and starts up with the **Global and White LED Config/Status** window selected (see Figure 1). Use the **Global Configuration/Status** section's checkboxes to enable/disable various MAX6964 global functions. The **Master Intensity** control track bar affects all RGB LEDs or outputs simultaneously. Deselecting a checkbox disables the respective function. Selecting the **Static Outputs** checkbox sets the **Master Intensity** control track bar to **0/15**. Deselect the **Static Outputs** checkbox to enable the track bar's full range of **1/15 to 15/15**.

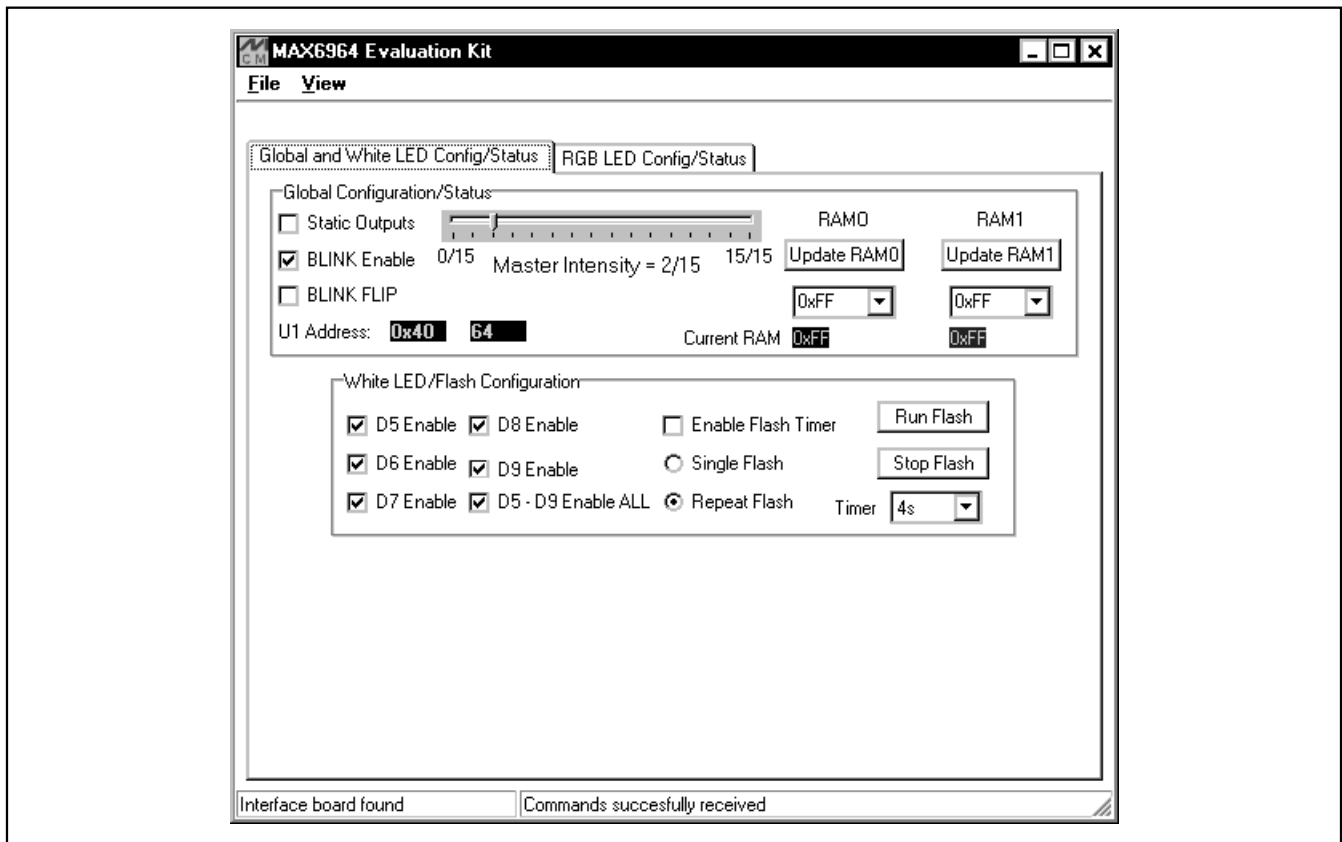

Figure 1. The MAX6964 Evaluation Kit Software Global and White LED Config/Status Main Window for Global Configuration, White LED and Flash Controls, and Software Status

MAX6964 Evaluation Kit/Evaluation System

Changes to RAM0 and RAM1 are entered in hexadecimal format (0x_ _) in the respective combo box. Select the respective **Update RAM0** or **Update RAM1** button to write the respective combo box entered values to the MAX6964 IC. The MAX6964 2-wire serial address is provided in hexadecimal and decimal format, respectively.

The **White LED/Flash Configuration** section is utilized to enable/disable the EV kit's white LEDs D5–D9 or to control all five white LEDs as a single flash unit. Flash features such as **Single Flash**, **Repeat Flash**, and time delays from **0.5s to 8s** duration can be selected or configured, respectively. Select the **Enable Flash Timer** checkbox, then select a flash time using the **Timer** combo box and press the **Run Flash** button. When running the flash, all global BLINK checkboxes are unchecked and all white LED checkboxes are disabled. Uncheck the **Enable Flash Timer** checkbox to enable all of the white LED checkboxes. **Warning: Do not continuously stare at white LEDs D5, D6, D7, D8, or D9.**

RGB LED Config/Status

The **RGB LED Config/Status** window (see Figure 2) provides full control of the EV kit's RGB LEDs, D1–D4. Select the respective **D_ Phase 0 Enable** checkbox to enable or disable the respective RGB LED. Select the **Phase 0 Red**, **Green**, or **Blue** checkboxes to enable the respective LED color during phase 0. When **Enable PWM** is selected, the RGB LED's track bar independently controls the respective LED's color intensity. When disabled, the track bars are set to full scale, reflecting the respective MAX6964 IC intensity register.

Select the **Phase 1 Red**, **Green**, or **Blue** boxes to enable the respective LED for demonstrating the phase 1 MAX6964 blinking mode of operation. The global **BLINK Enable** must be selected on the **Global and White LED Config/Status** tab window for the blink function to work.

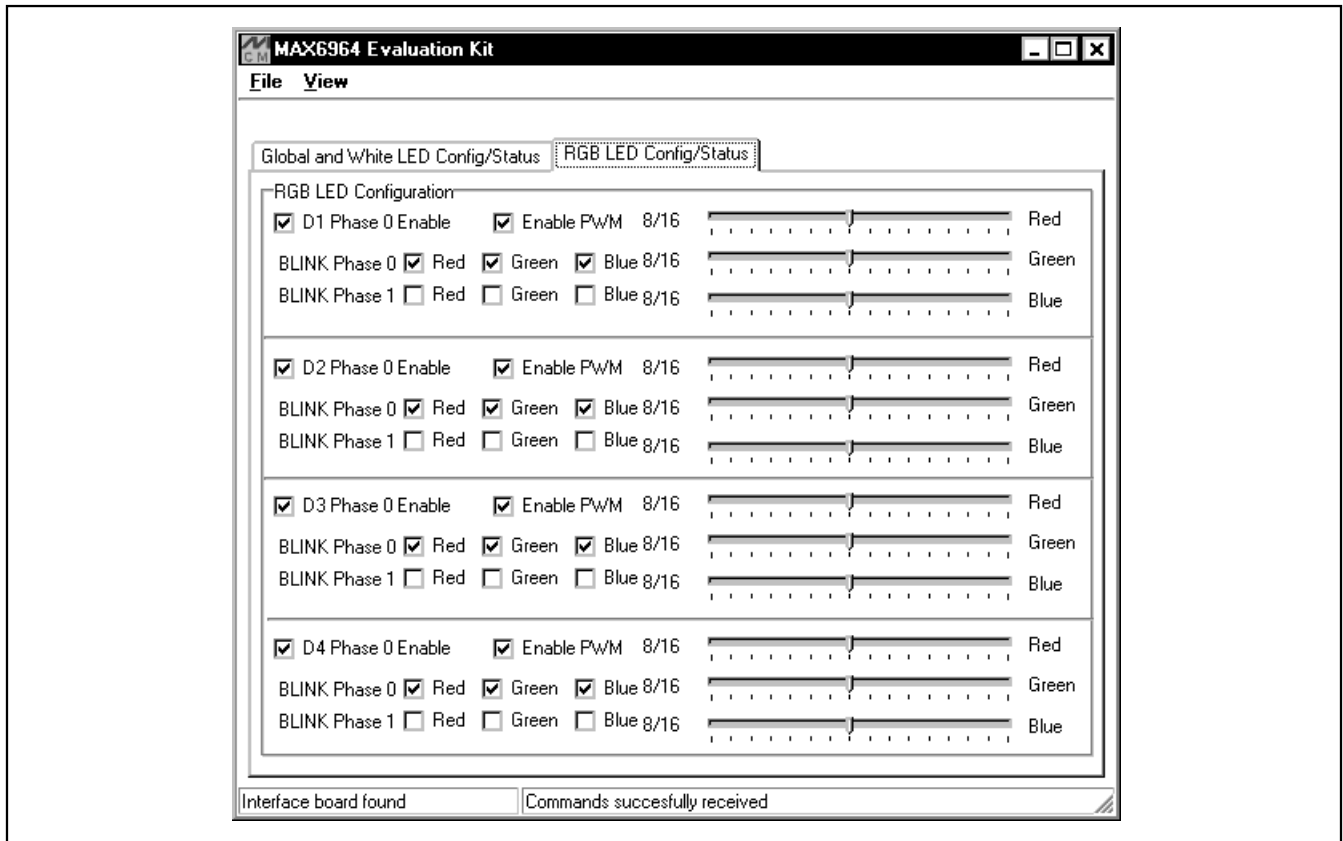

Figure 2. The MAX6964 Evaluation Kit Software RGB LED Config/Status Window for Configuring the RGB LEDs, D1–D4

MAX6964 Evaluation Kit/Evaluation System

Evaluate: MAX6964

General-Purpose 2-Wire Interface Utility

The general-purpose **2-wire interface** utility can also be used to communicate with the MAX6964, and thus, control or read back signals from the MAX6964. Use the **View | Interface** pulldown menu to access the utility. The utility configures the 2-wire serial-interface parameters, such as start and stop bits, acknowledgements, and clock timing. The 2-wire interface screen allows you to send general-purpose 2-wire commands using the **SMBusWriteByte** and **SMBusReadByte**. The interface utility only accepts and outputs hexadecimal number format.

The **Hunt for active listeners** button scans the entire 2-wire address space, reporting each address that is acknowledged. The **SMBusWriteByte** transmits the device address, command, and one byte of data. The **SMBusReadByte** transmits the device address, a command, and then retransmits the device address and reads one byte of data.

For information on the differences between a 2-wire and an SMBus™ interface, read Application Note 476: *Comparing the I²C Bus to the SMBus* at www.maxim-ic.com.

SMBus is a trademark of Intel Corp.

General Troubleshooting

Problem: Software reports it cannot find the interface board.

- Is the interface board power LED lit?
- Is the USB communications cable connected?
- Has Windows plug-and-play detected the board? Bring up **Control Panel | System | Device Manager**, and look at what device nodes are indicated for USB. If there is an unknown device node attached to the USB, delete it. This process forces plug-and-play to try again.

Problem: Unable to find U1.

- Is power applied to the MAX6964 EV kit VIN PCB pad or is jumper JU1 configured to pins 2 and 3 to receive power from the CMAXQUSB interface board? This is required for powering U1.
- Are the SCL and SDA signals pulled up to VDD? The CMAXQUSB interface board dipswitch SW1 enables the on-board resistors on the interface board. There must be pullup resistors somewhere for the 2-wire SCL and SDA signals.
- If using jumper wires to connect, are the SCL and SDA signals swapped? Is the ground return missing?

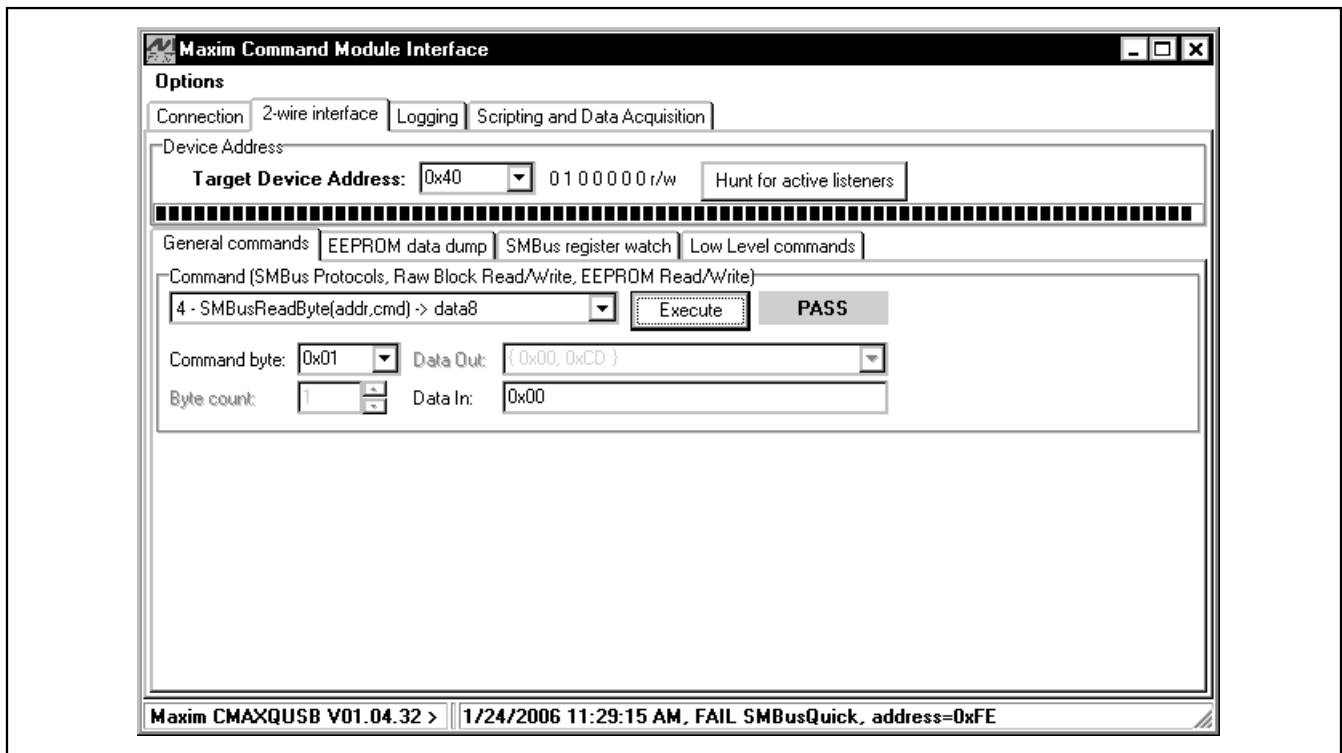

Figure 3. The 2-Wire Interface Window Provides Direct, Low-Level Access to the MAX6964 and 2-Wire Serial Interface

MAX6964 Evaluation Kit/Evaluation System

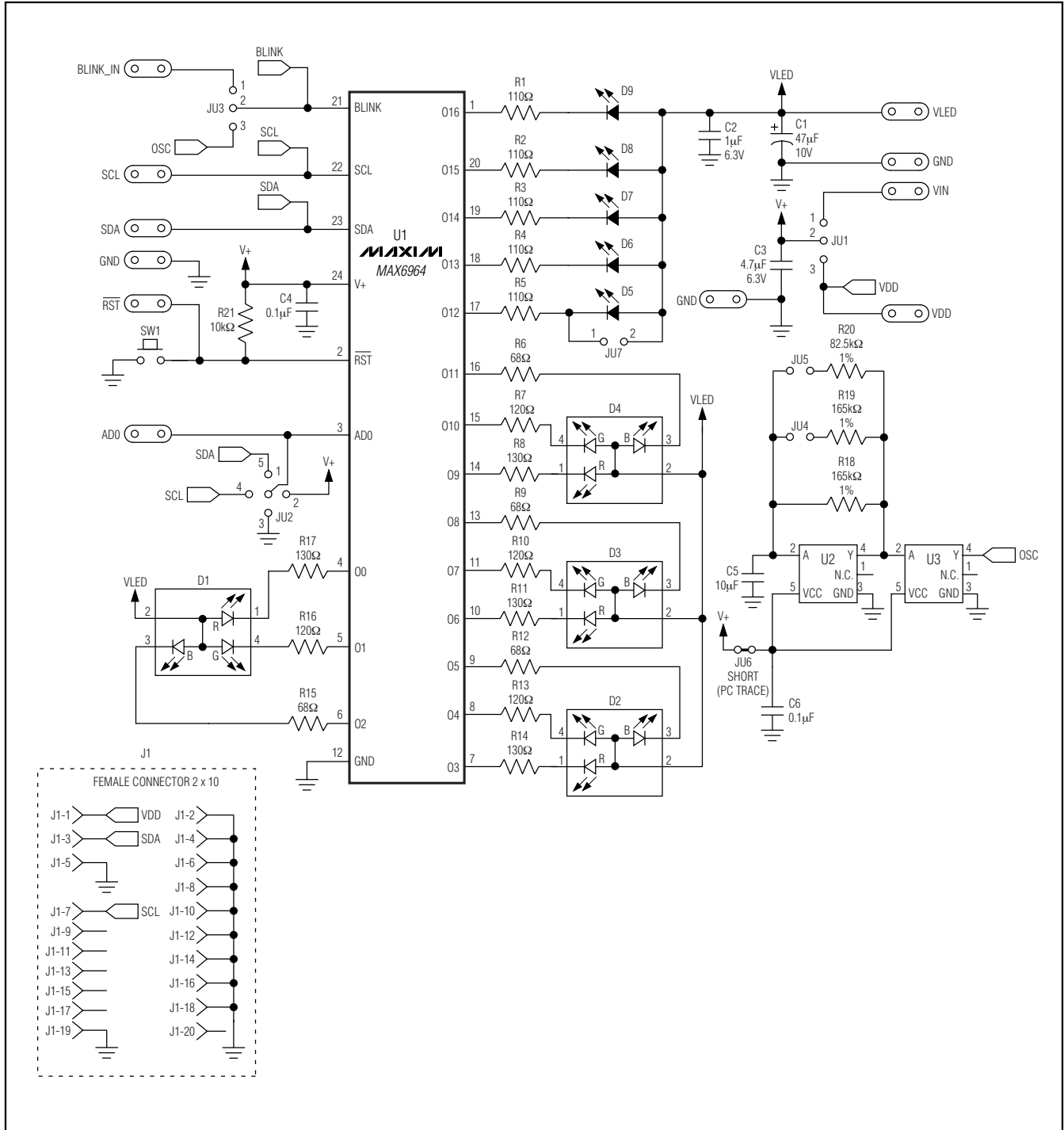

Figure 4. MAX6964 EV Kit Schematic

MAX6964 Evaluation Kit/Evaluation System

Evaluate: MAX6964

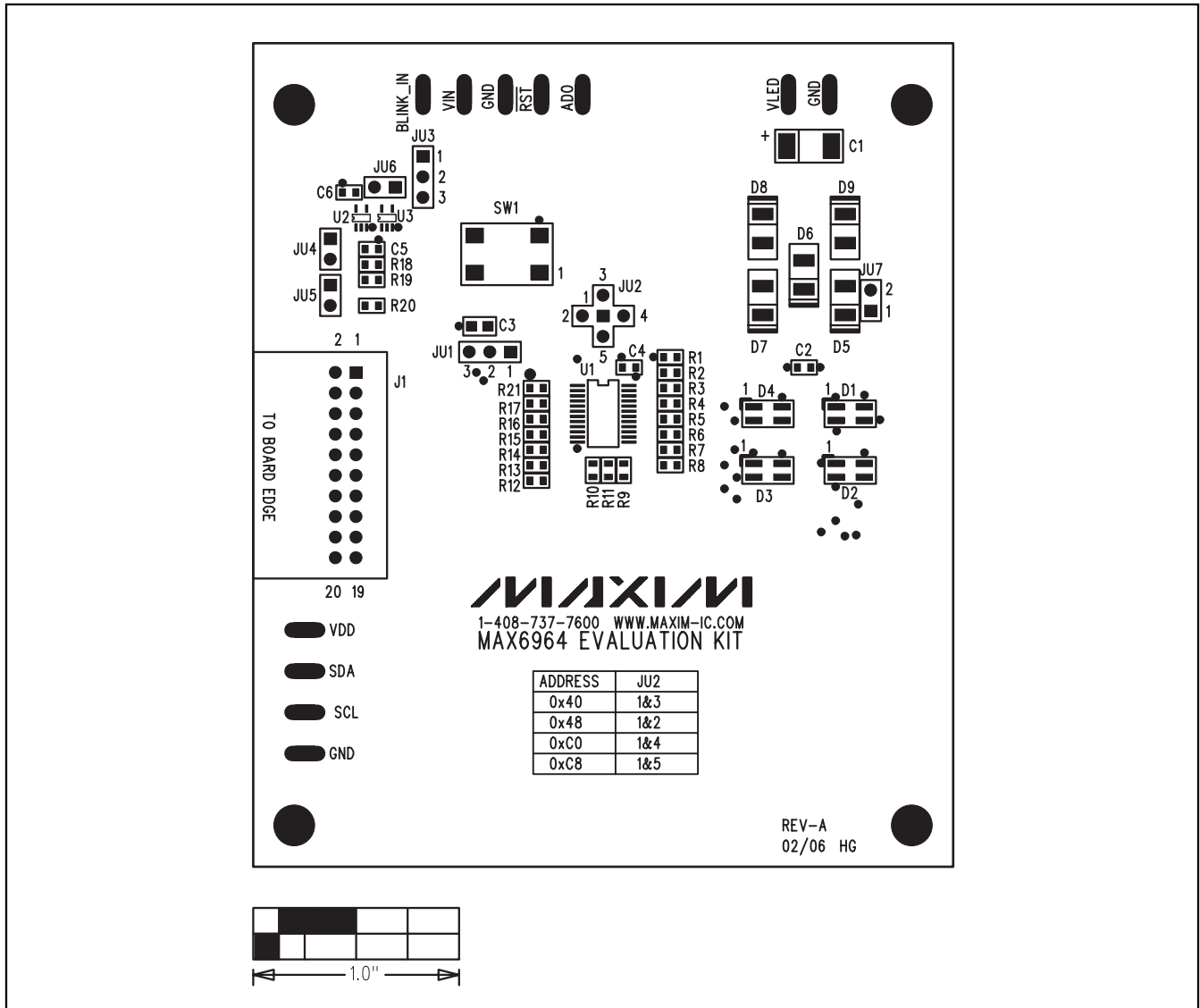

Figure 5. MAX6964 EV Kit Component Placement Guide—Component Side

MAX6964 Evaluation Kit/Evaluation System

Evaluate: MAX6964

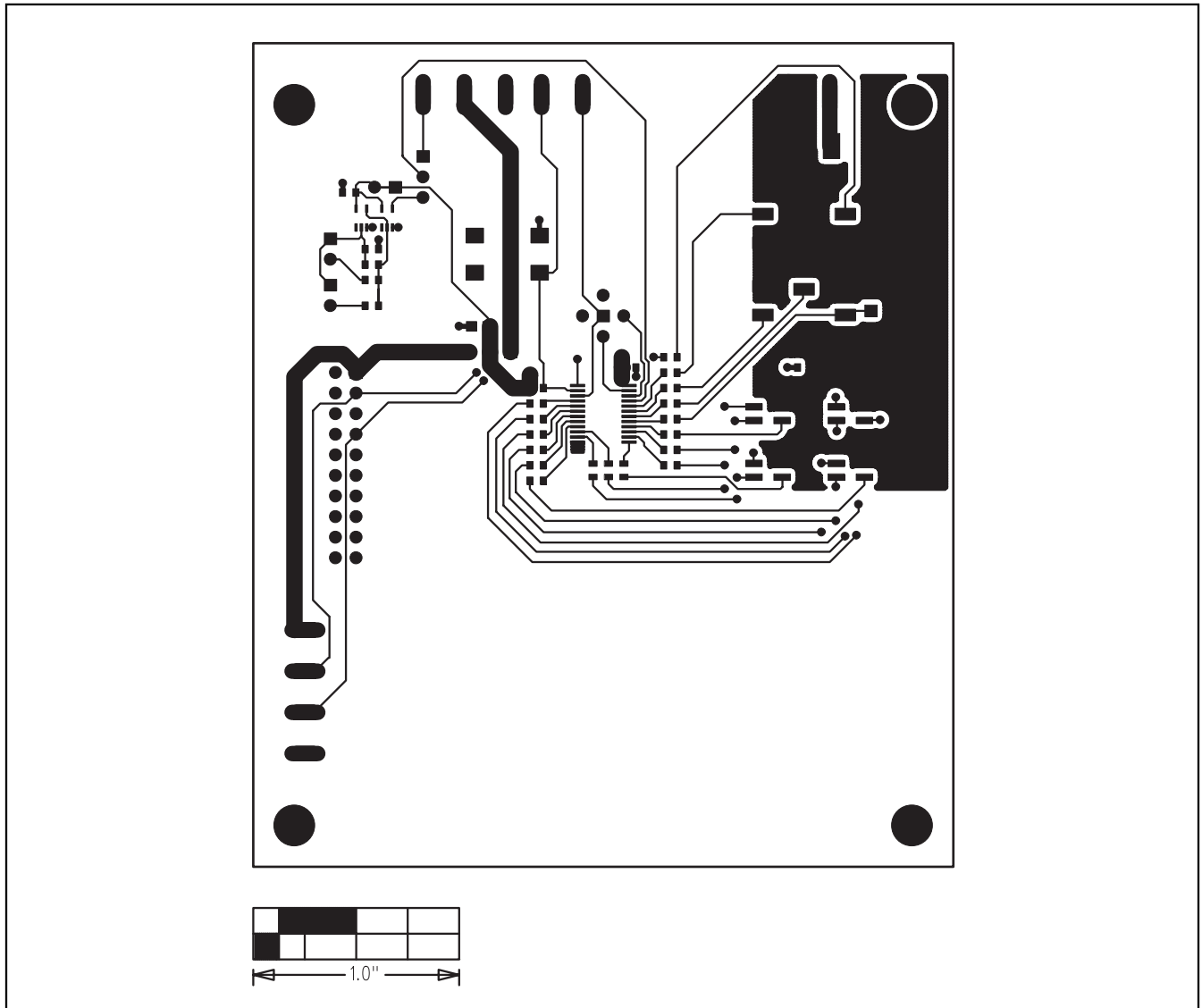

Figure 6. MAX6964 EV Kit PCB Layout—Component Side

MAX6964 Evaluation Kit/Evaluation System

Evaluate: MAX6964

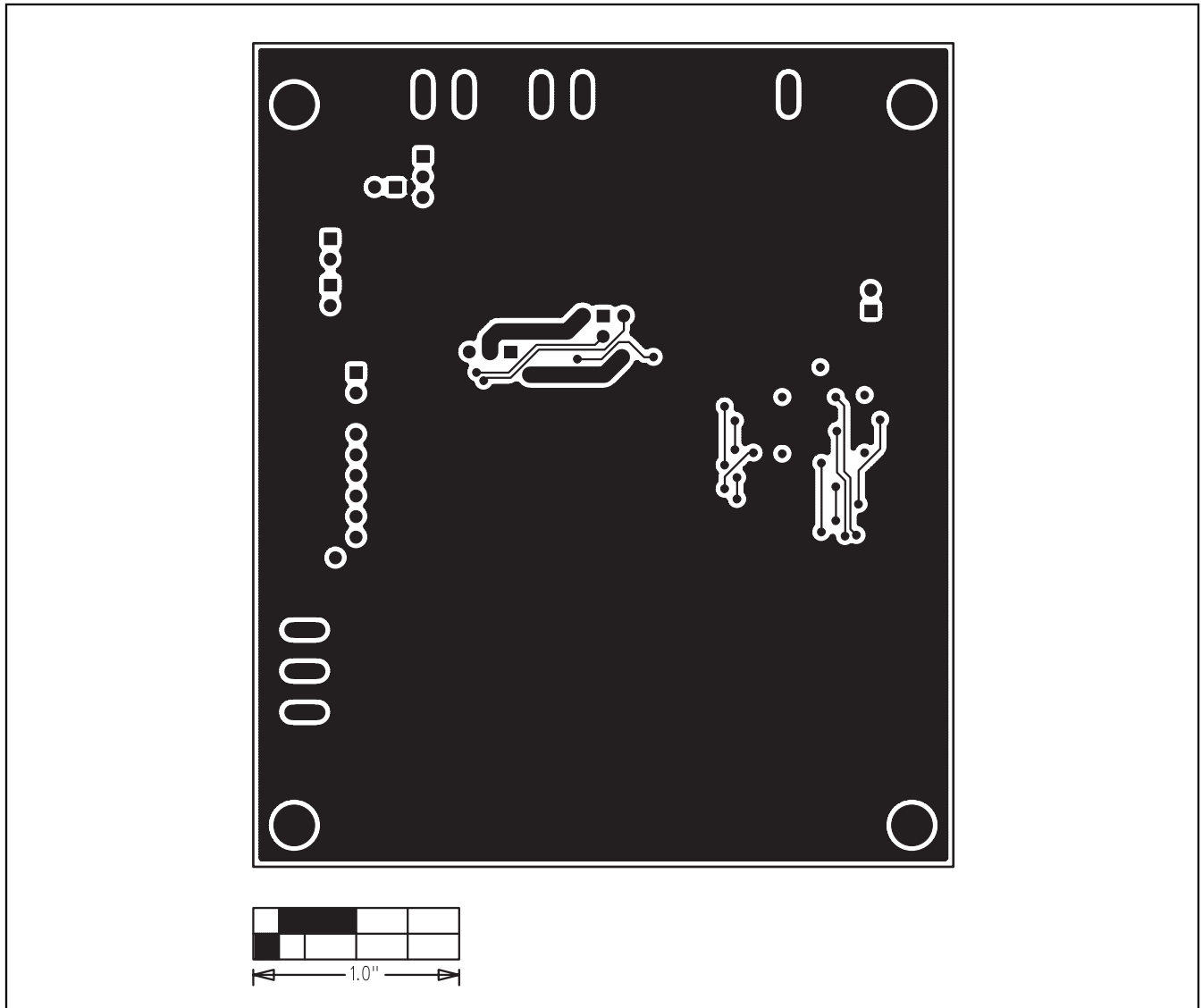

Figure 7. MAX6964 EV Kit PCB Layout—Solder Side

Revision History

Pages changed at Rev 1: 1-4, 7, 8, 10, 11

Maxim cannot assume responsibility for use of any circuitry other than circuitry entirely embodied in a Maxim product. No circuit patent licenses are implied. Maxim reserves the right to change the circuitry and specifications without notice at any time.

Maxim Integrated Products, 120 San Gabriel Drive, Sunnyvale, CA 94086 408-737-7600 _____ 11