

MAX15109 Evaluation Kit

Evaluates: MAX15109

General Description

The MAX15109 evaluation kit (EV kit) provides a proven design to evaluate the MAX15109 high-efficiency, 8A, step-down regulator with integrated switches in a 20-bump wafer-level package (WLP). The EV kit provides four output voltages at load currents up to 8A from a 2.7V to 5.5V input supply. The output voltages are set using two VID control inputs. The device features a 1MHz fixed switching frequency, which allows the EV kit to achieve an all-ceramic capacitor design and fast transient responses.

Features

- ◆ Operates from a 2.7V to 5.5V Input Supply
- ◆ All-Ceramic Capacitor Design
- ◆ 1MHz Switching Frequency
- ◆ VID Control Inputs for Selecting Output Voltage
- ◆ Enable Input/Power-Good Output
- ◆ Skip-Mode Operation
- ◆ Proven PCB Layout
- ◆ Fully Assembled and Tested

[Ordering Information](#) appears at end of data sheet.

Component List

DESIGNATION	QTY	DESCRIPTION
C1, C2, C19	3	10 μ F \pm 10%, 6.3V X5R ceramic capacitors (0603) Murata GRM188R60J106K TDK C1608X5R0J106K
C3, C4, C21	0	Not installed, ceramic capacitors (0603)
C6	1	2200pF \pm 10%, 50V X7R ceramic capacitor (0603) Murata GRM188R71H222K TDK C1608X7R1H222K
C7–C10	4	47 μ F \pm 20%, 6.3V X5R ceramic capacitors (1206) Murata GRM31CR60J476M TDK C3216X5R0J476M
C14	1	100pF \pm 5%, 50V C0G ceramic capacitor (0603) Murata GRM1885C1H101J TDK C1608C0G1H101J
C15	1	4700pF \pm 10%, 50V X7R ceramic capacitor (0603) Murata GRM188R71H472K TDK C1608X7R1H472K
C16	1	0.033 μ F \pm 10%, 16V X7R ceramic capacitor (0603) Murata GRM188R71C333K Taiyo Yuden EMK107BJ333KA

DESIGNATION	QTY	DESCRIPTION
C20	1	1 μ F \pm 10%, 6.3V X7R ceramic capacitor (0603) Murata GRM188R70J105K
C22	0	Not installed, 220 μ F \pm 20%, 10V aluminum electrolytic capacitor (6.3mm x 7.7mm)
C23	1	2.2 μ F \pm 10%, 10V X7R ceramic capacitor (0603) Murata GRM188R71A225K
JU1	1	2-pin header
JU2, JU3	2	3-pin headers
L1	1	0.33 μ H, 18A inductor Vishay IHLP2525BD01R33M01
R1	1	0 Ω \pm 5% resistor (0603)
R2, R11, R12	0	Not installed, resistors (0603)
R3	1	2.43k Ω \pm 1% resistor (0603)
R4, R5	2	100k Ω \pm 5% resistors (0603)
R6	1	10 Ω \pm 5% resistor (0603)
R8	1	1 Ω \pm 1% resistor (0805)
R9	1	1k Ω \pm 5% resistor (0603)
R10, R13	2	10k Ω \pm 5% resistors (0603)
U1	1	8A current-mode buck converter (20 WLP) Maxim MAX15109EWP+
—	3	Shunts
—	1	PCB: MAX15109 EVALUATION KIT

MAX15109 Evaluation Kit

Evaluates: MAX15109

Component Suppliers

SUPPLIER	PHONE	WEBSITE
Murata Electronics North America, Inc.	770-436-1300	www.murata-northamerica.com
Taiyo Yuden	800-348-2496	www.t-yuden.com
TDK Corp.	847-803-6100	www.component.tdk.com
Vishay	402-563-6866	www.vishay.com

Note: Indicate that you are using the MAX15109 when contacting these component suppliers.

Quick Start

Recommended Equipment

- MAX15109 EV kit
- 5V, 3A DC power supply
- Load capable of sinking 8A
- Digital voltmeter

Procedure

The EV kit is fully assembled and tested. Follow the steps below to verify the board operation. **Caution: Do not turn on power supply until all connections are completed.**

- 1) Connect the positive terminal of the 5V supply to the IN PCB pad and the negative terminal to the nearest PGND PCB pad.
- 2) Connect the positive terminal of the 8A load to the OUT PCB pad and the negative terminal to the nearest PGND PCB pad.
- 3) Connect the digital voltmeter across the OUT PCB pad and the nearest PGND PCB pad.
- 4) Verify that a shunt is installed on jumper JU1.
- 5) Verify that a shunt is installed on pins 2-3 on jumper JU2.
- 6) Verify that a shunt is installed across pins 2-3 on jumper JU3.
- 7) Turn on the DC power supply.
- 8) Enable the load.
- 9) Verify that the voltmeter displays 0.9V.

Detailed Description of Hardware

The MAX15109 EV kit provides a proven design to evaluate the MAX15109 high-efficiency, 8A, step-down regulator with integrated switches. The applications include distributed power systems, portable devices, and preregulators. The EV kit output voltage is selected using the VID0 and VID1 control inputs at load currents up to 8A from a 2.7V to 5.5V input supply. The device automatically operates in skip mode to achieve higher efficiency at light loads. The device features a 1MHz fixed switching frequency, which allows the EV kit to achieve an all-ceramic capacitor design and fast transient response. A placeholder for an input aluminum electrolytic capacitor (C22) is provided to damp the input if long wires are used; they are not required in a tight system design.

Soft-Start (SS)

The device utilizes an adjustable soft-start function to limit inrush current during startup. The soft-start time is adjusted by the value of C16, the external capacitor from SS to GND. By default, C16 is currently 0.033μF, which gives a soft-start time of approximately 2ms. To adjust the soft-start time, determine C16 using the following formula:

$$C16 = (10\mu A \times t_{SS}) / 0.6V$$

where t_{SS} is the required soft-start time in seconds and C16 is in farads. This capacitor sets the slew rate to reduce input current at startup when the output changes state under VID control.

Regulator Enable (EN)

The device features an enable input. For normal operation, a shunt should be installed across jumper JU1. To disable the output, remove the shunt on JU1 and the EN pin is pulled to PGND through resistor R4. See Table 1 for jumper JU1 settings.

MAX15109 Evaluation Kit

Evaluates: MAX15109

Setting the Output Voltage

The output voltage is selected by using the VID0 and VID1 control inputs. The 3-pin jumper JU2 controls the

VID1 logic input, while the 3-pin jumper JU3 controls the VID0 logic input. Table 2 summarizes the output voltages.

Table 1. Regulator Enable (EN) Jumper JU1 Description

SHUNT POSITION	EN PIN	DEVICE OUTPUT
Installed*	Connected to IN	Enabled
Not installed	Pulled to PGND through R4	Disabled

*Default position.

Table 2. Output Voltages Jumpers JU2 and JU3 Description

SHUNT POSITION		VID0	VID1	OUT (V)
JU3	JU2			
2-3*	2-3*	0	0	0.9
2-3	1-2	0	1	0.8
1-2	2-3	1	0	0.725
1-2	1-2	1	1	0.675

*Default position.

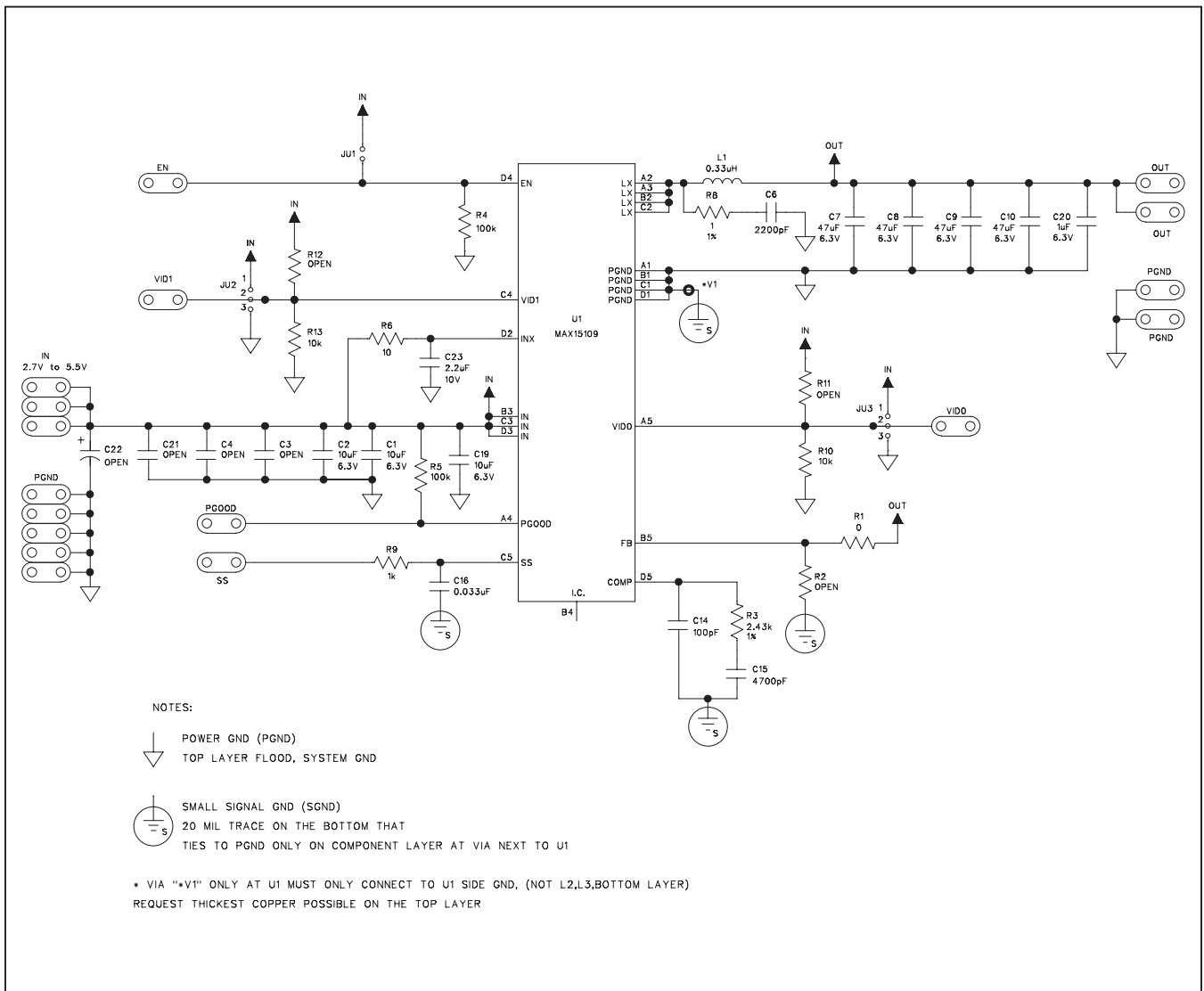

Figure 1. MAX15109 EV Kit Schematic

MAX15109 Evaluation Kit

Evaluates: MAX15109

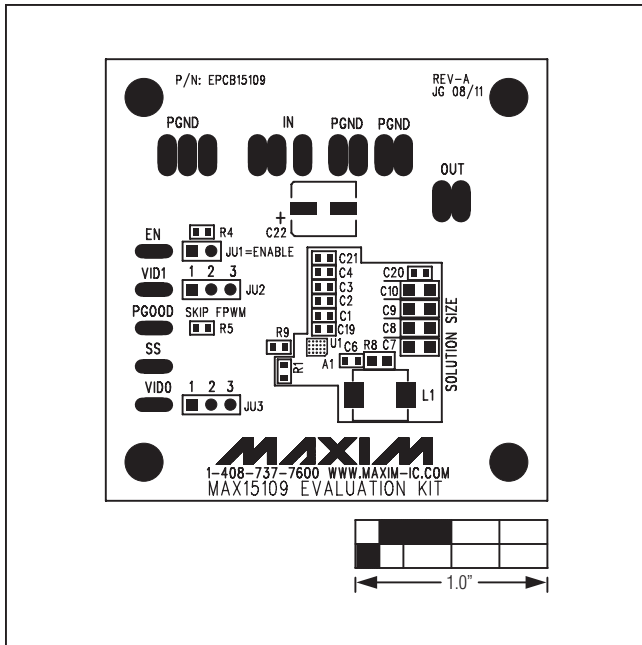

Figure 2. MAX15109 EV Kit Component Placement Guide—Component Side

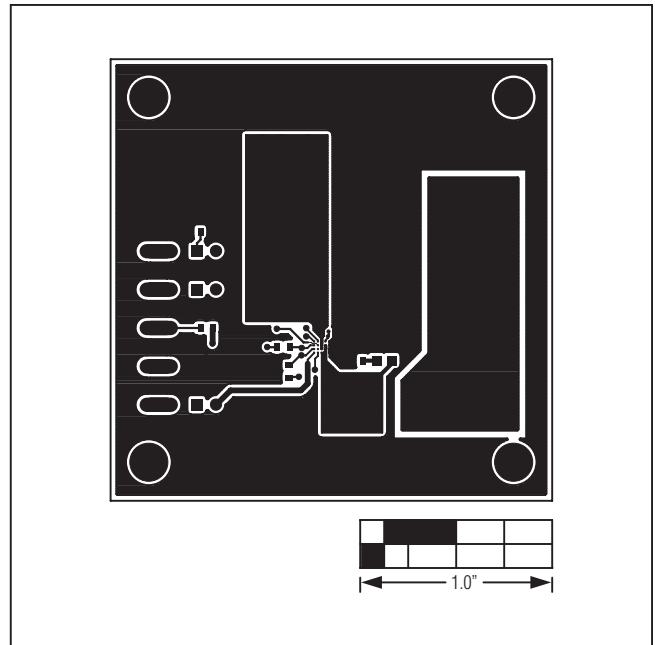

Figure 3. MAX15109 EV Kit Component PCB Layout—Component Side

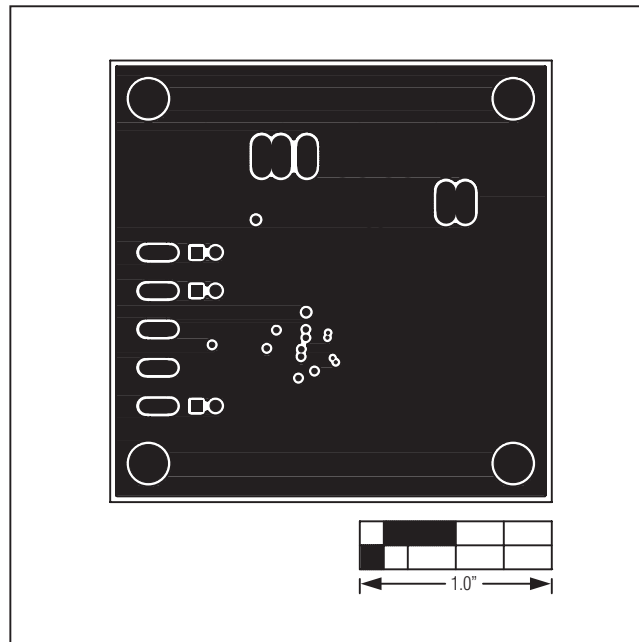

Figure 4. MAX15109 EV Kit PCB Layout—Inner Layer 2

MAX15109 Evaluation Kit

Evaluates: MAX15109

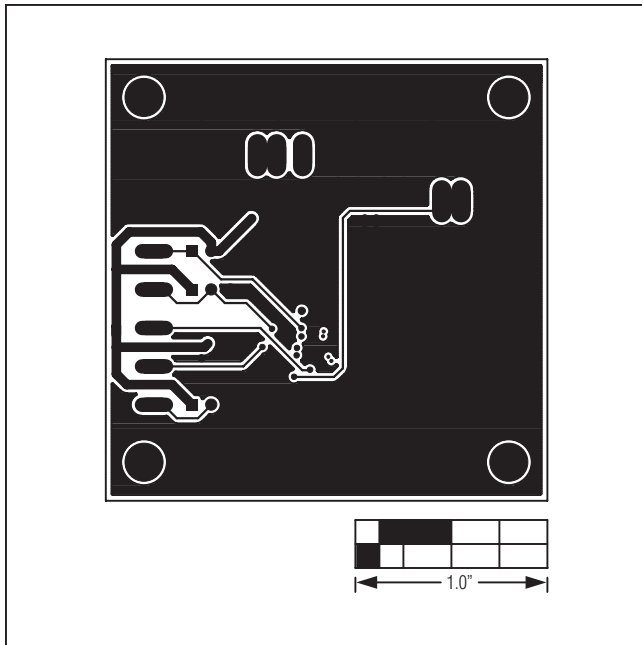

Figure 5. MAX15109 EV Kit PCB Layout—Inner Layer 3

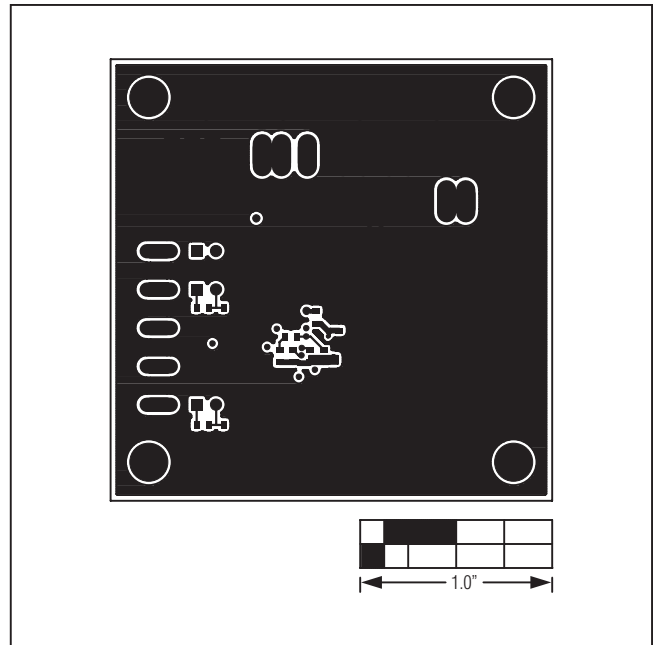

Figure 6. MAX15109 EV Kit PCB Layout—Solder Side

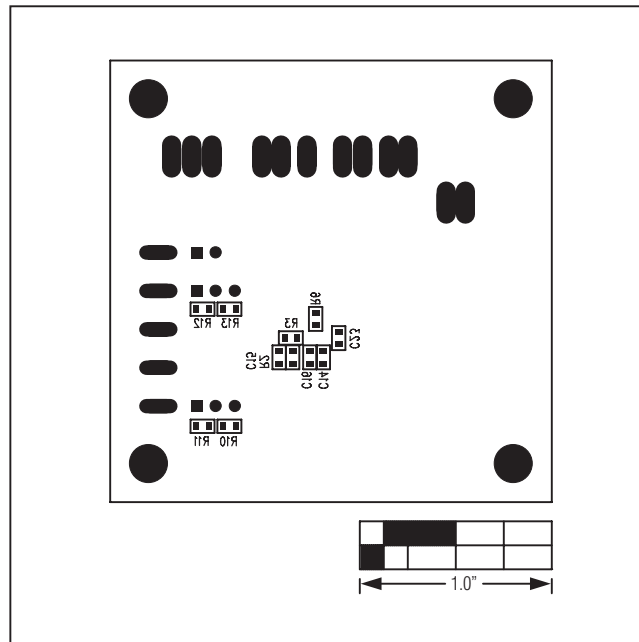

Figure 7. MAX15109 EV Kit Component Placement Guide—Solder Side

MAX15109 Evaluation Kit

Evaluates: MAX15109

Ordering Information

PART	TYPE
MAX15109EVKIT#	EV Kit

#Denotes RoHS compliant.

MAX15109 Evaluation Kit

Evaluates: MAX15109

Revision History

REVISION NUMBER	REVISION DATE	DESCRIPTION	PAGES CHANGED
0	11/11	Initial release	—

Maxim cannot assume responsibility for use of any circuitry other than circuitry entirely embodied in a Maxim product. No circuit patent licenses are implied. Maxim reserves the right to change the circuitry and specifications without notice at any time.

Maxim Integrated Products, 120 San Gabriel Drive, Sunnyvale, CA 94086 408-737-7600 _____ 7