

# MAX14983E Evaluation Kit

## Evaluates: MAX14983E

### General Description

The MAX14983E evaluation kit (EV kit) is a fully assembled and tested surface-mount PCB that utilizes the MAX14983E VGA multiplexer to implement a 1:2 video graphics array circuit. The IC switches graphics signals between a controller and two outputs.

VGA input/output connections are provided to easily interface the EV kit with VGA-compatible devices. The EV kit provides LEDs to indicate the status of the monitor-detection outputs. The EV kit operates with a single 5V supply input.

### Features

- ◆ Complete 1:2 VGA Multiplexer
- ◆ Single 5V Power Supply
- ◆ VGA Inputs/Outputs
- ◆ Enable Inputs
- ◆ Monitor-Detection Outputs
- ◆ Proven PCB Layout
- ◆ Fully Assembled and Tested

[Ordering Information](#) appears at end of data sheet.

### Component List

DESIGNATION	QTY	DESCRIPTION
C1	1	10 $\mu$ F $\pm$ 10%, 10V X7R ceramic capacitor (1206) Murata GRM31CR71A106K
C2–C7	6	0.1 $\mu$ F $\pm$ 10%, 16V X7R ceramic capacitors (0603) Murata GRM188R71C104K
C8–C11	0	Not installed, capacitors (0603)
C12, C16	2	1 $\mu$ F $\pm$ 10%, 10V X7R ceramic capacitors (0603) Murata GRM188R71A105K
D1, D2	2	40V, 500mA Schottky diodes (SOT563) Central Semi CMLSH05-4+
D3–D8	6	Green LEDs (1206)
GND	1	Black test point
J0, J1, J2	3	15-pin VGA, HD sub-D, 15-pin female connectors
JU1, JU2	2	3-pin headers
JU3, JU4	2	2-pin headers

DESIGNATION	QTY	DESCRIPTION
Q1, Q2, Q3	3	General-purpose pnp transistors (SOT23) Fairchild MMBT5087
R1, R2, R3, R10, R11, R12	6	560 $\Omega$ $\pm$ 5% resistors (0603)
R4, R5, R6	3	100k $\Omega$ $\pm$ 5% resistors (0603)
R7, R8, R9	3	47k $\Omega$ $\pm$ 5% resistors (0603)
R13–R16	4	39 $\Omega$ $\pm$ 5% resistors (0603)
R17, R18	2	3.3k $\Omega$ $\pm$ 5% resistors (0603)
R19	1	330 $\Omega$ $\pm$ 1% resistor (0603)
U1	1	1:2 VGA multiplexer with monitor detection (32 TQFN-EP*) Maxim MAX14983EETJ+
U2	1	3.3V LDO linear regulator (5 SC70) Maxim MAX8511EXK33+
VCC	1	Red test point
—	4	Shunts
—	1	PCB: MAX14983E EVALUATION KIT

\*EP = Exposed pad.

### Component Suppliers

SUPPLIER	PHONE	WEBSITE
Central Semiconductor Corp.	631-435-1110	www.centralsemi.com
Fairchild Semiconductor	888-522-5372	www.fairchildsemi.com
Murata Electronics North America, Inc.	770-436-1300	www.murata-northamerica.com

**Note:** Indicate that you are using the MAX14983E when contacting these component suppliers.

# MAX14983E Evaluation Kit

## Evaluates: MAX14983E

### Quick Start

#### Recommended Equipment

- MAX14983E EV kit
- Single 5V power supply
- VGA-compatible output (e.g., notebook computer docking stations)
- VGA-compatible input (e.g., monitor)

#### Procedure

The EV kit is a fully assembled and tested surface-mount PCB. Follow the steps below to verify board operation:

- 1) Verify that jumpers are configured in the following positions:
  - JU1, JU2: Pins 2-3
  - JU3, JU4: Not installed
- 2) Connect the positive terminal of the 5V power supply to the VCC test point on the EV kit. Connect the negative terminal of the power supply to the GND test point on the EV kit.
- 3) Connect the VGA source to connector J0 (VGA host).
- 4) Connect the VGA output to connector J1 (VGA monitor 1).
- 5) Enable the 5V power supply.
- 6) Enable the VGA source.
- 7) Visually verify that the VGA monitor shows the information from the source.
- 8) See Table 1 for other states of the VGA controller.

**Table 1. Channel Selection**

SHUNT POSITIONS		VGA CONTROLLER CONNECTED TO
JU1	JU2	
2-3*	2-3*	VGA monitor 1
2-3	1-2	VGA monitor 1
1-2	2-3	VGA monitor 2
1-2	1-2	Not connected

\*Default position.

### Detailed Description

The MAX14983E EV kit evaluates the MAX14983E enhanced 1:2 VGA mux with monitor detection and priority port logic. VGA connectors are provided to easily interface the EV kit with VGA devices. The EV kit provides jumpers to control the enable inputs. The EV kit also provides status LEDs to monitor the monitor-detection outputs. The EV kit operates from a single 5V power supply.

#### Enable Inputs (Channel Selection)

The EV kit provides jumpers JU1 and JU2 to control device enable inputs  $\overline{EN1}$  and  $\overline{EN2}$ , respectively. The enable inputs control the high-bandwidth switches to route the standard VGA R, G, and B signals. Assert  $\overline{EN1}$  to connect the graphics controller to the monitor on port 1. Assert  $\overline{EN2}$  to connect the graphics controller to the monitor on port 2. Table 1 summarizes the device's channel selection.

#### Monitor Detection and Automatic Switching

The EV kit provides LEDs (D5, D6, D7) to indicate the status of the device's three monitor-detection outputs ( $\overline{MD1}$ ,  $\overline{MD2}$ , and  $\overline{MDOR}$ ). When any of the monitor-detection outputs are asserted, its respective LED turns on.

The device automatically switches the graphics controller to the monitor that is plugged in when configured in automatic mode. To configure automatic mode, leave jumpers JU1 and JU2 open and place shunts on both jumpers JU3 and JU4. This connects  $\overline{MD1}$  and  $\overline{MD2}$  to  $\overline{EN1}$  and  $\overline{EN2}$ , respectively. If a monitor is detected in both VGA ports simultaneously, the multiplexer defaults to port 1.

Table 2 summarizes the device's monitor-detection feature.

**Table 2. Monitor Detection**

MONITOR 1 DETECTED	MONITOR 2 DETECTED	$\overline{MD1}$	$\overline{MD2}$	$\overline{MDOR}$
No	No	High	High	High
No	Yes	High	Low	Low
Yes	No	Low	High	Low
Yes	Yes	Low	Low	Low

# MAX14983E Evaluation Kit

## Evaluates: MAX14983E

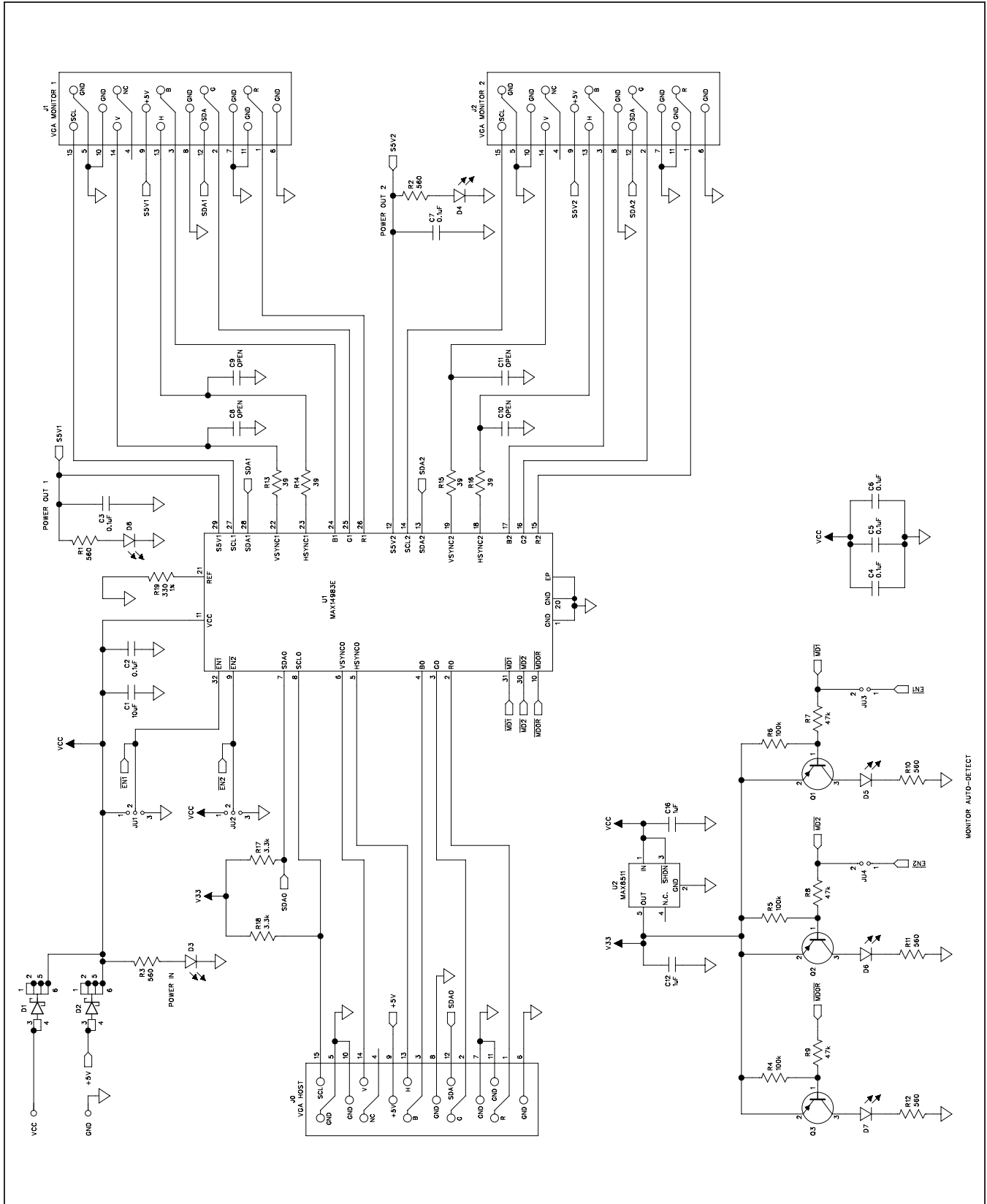

Figure 1. MAX14983E EV Kit Schematic

# MAX14983E Evaluation Kit

## Evaluates: MAX14983E

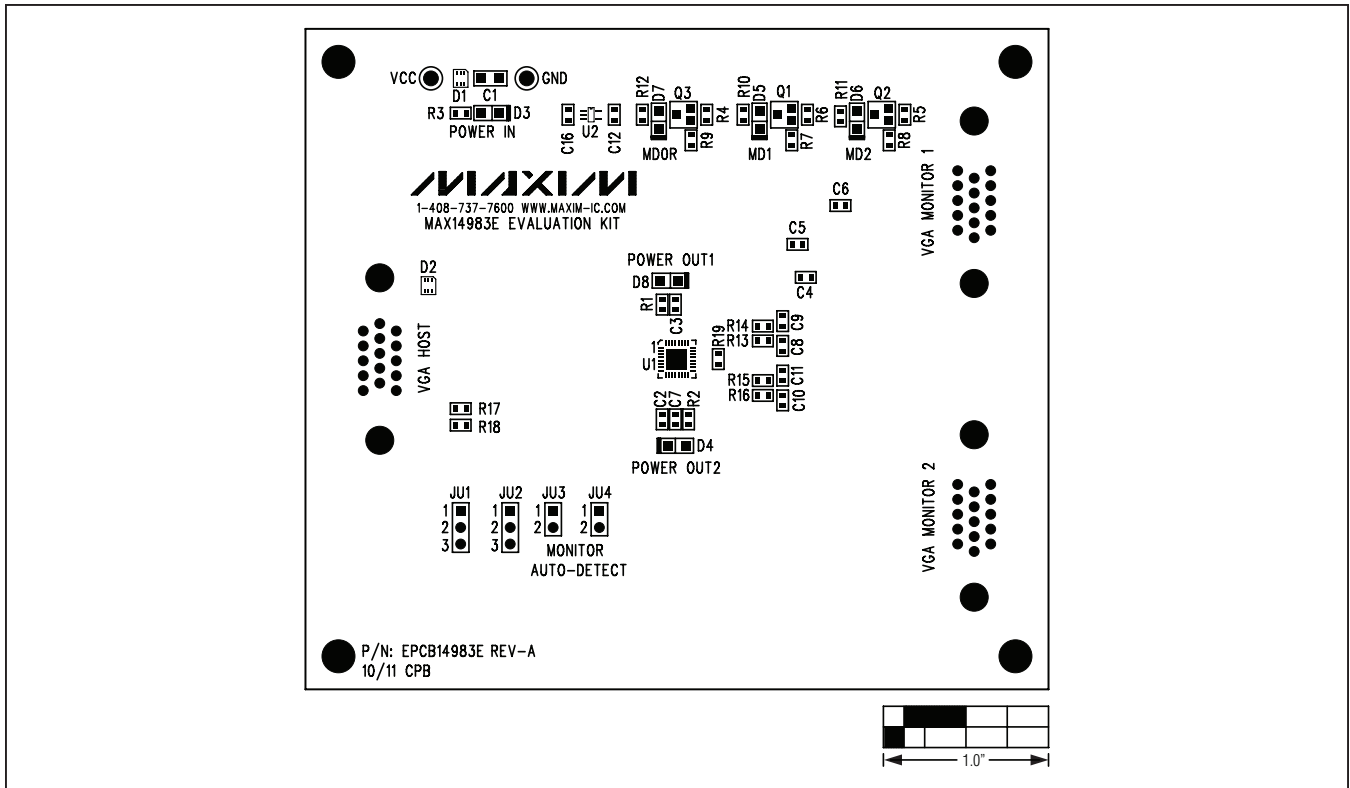

Figure 2. MAX14983E EV Kit Component Placement Guide—Top Silkscreen

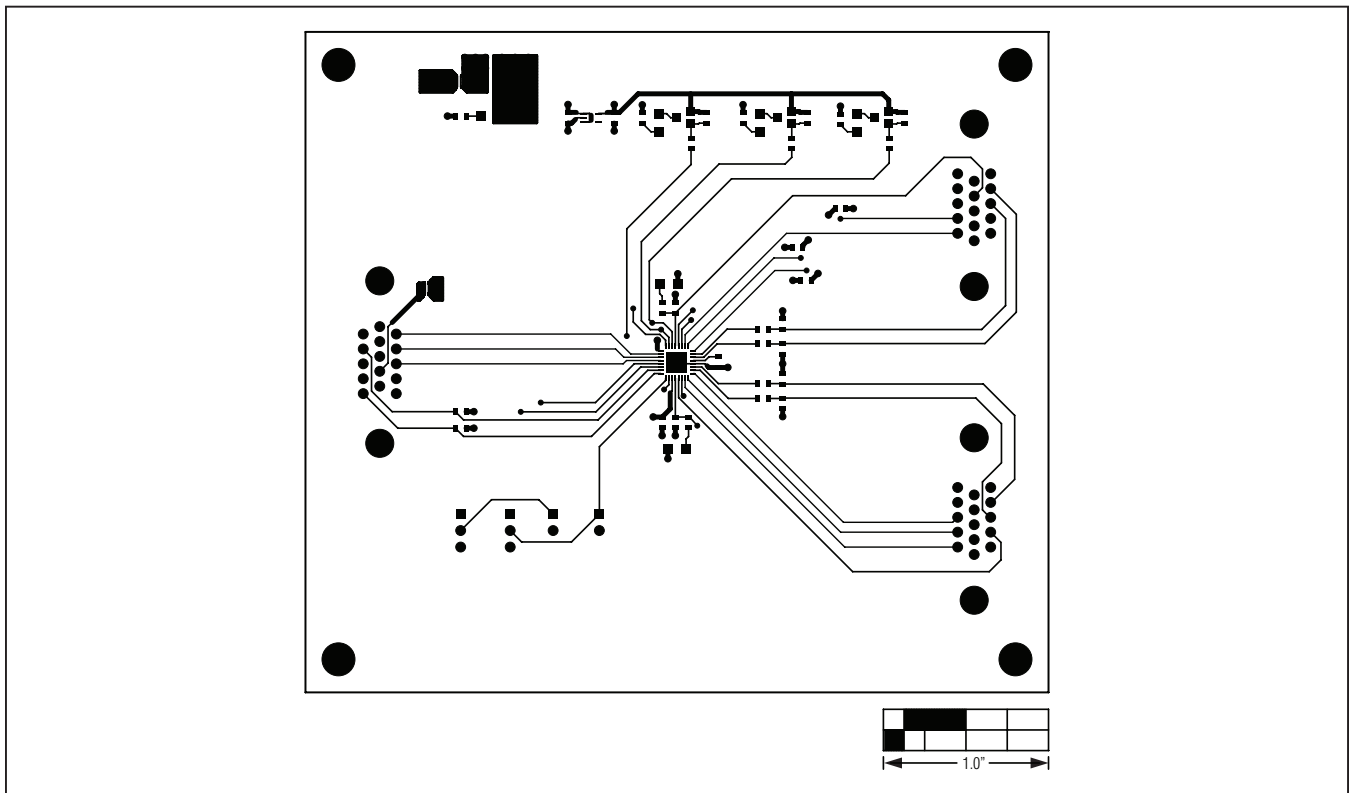

Figure 3. MAX14983E EV Kit PCB Layout—Component Side

# MAX14983E Evaluation Kit

## Evaluates: MAX14983E

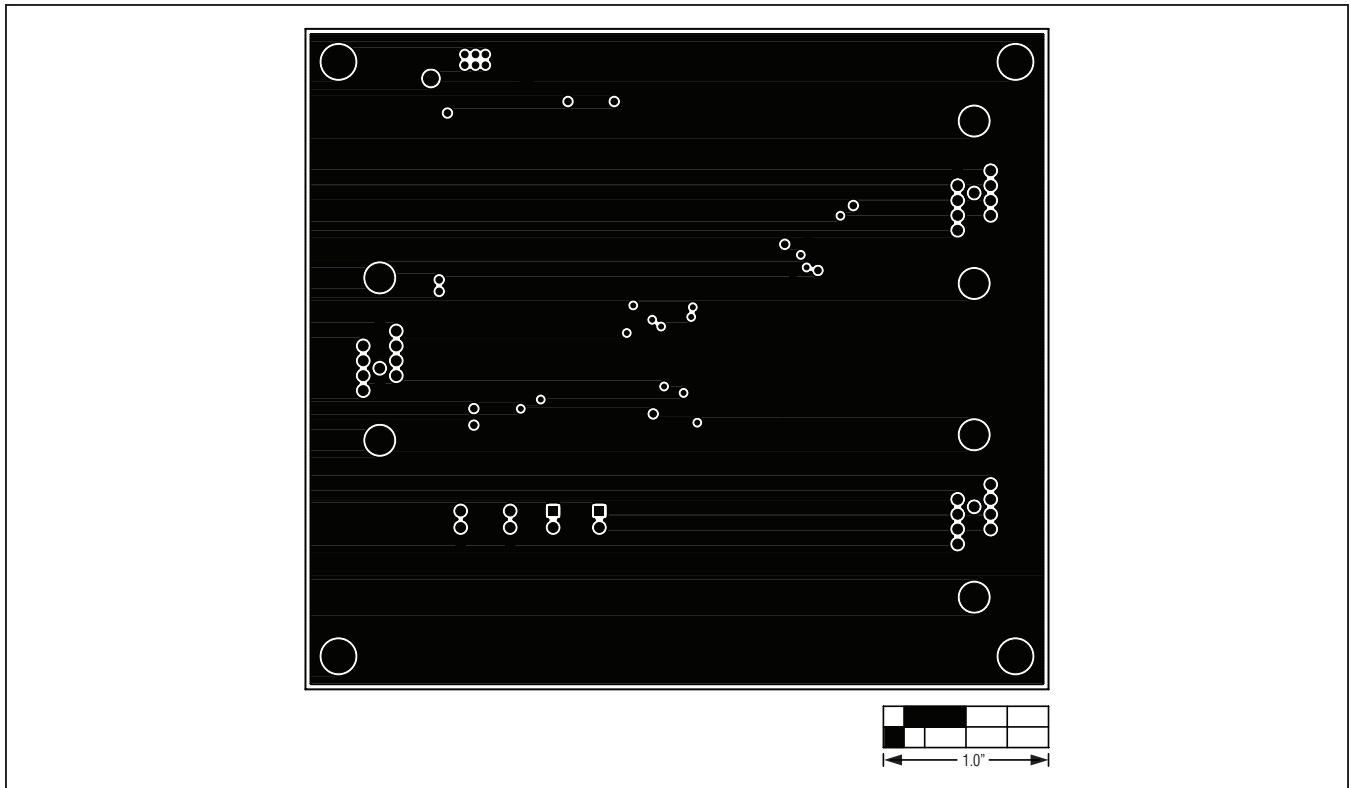

Figure 4. MAX14983E EV Kit PCB Layout—GND Layer 2

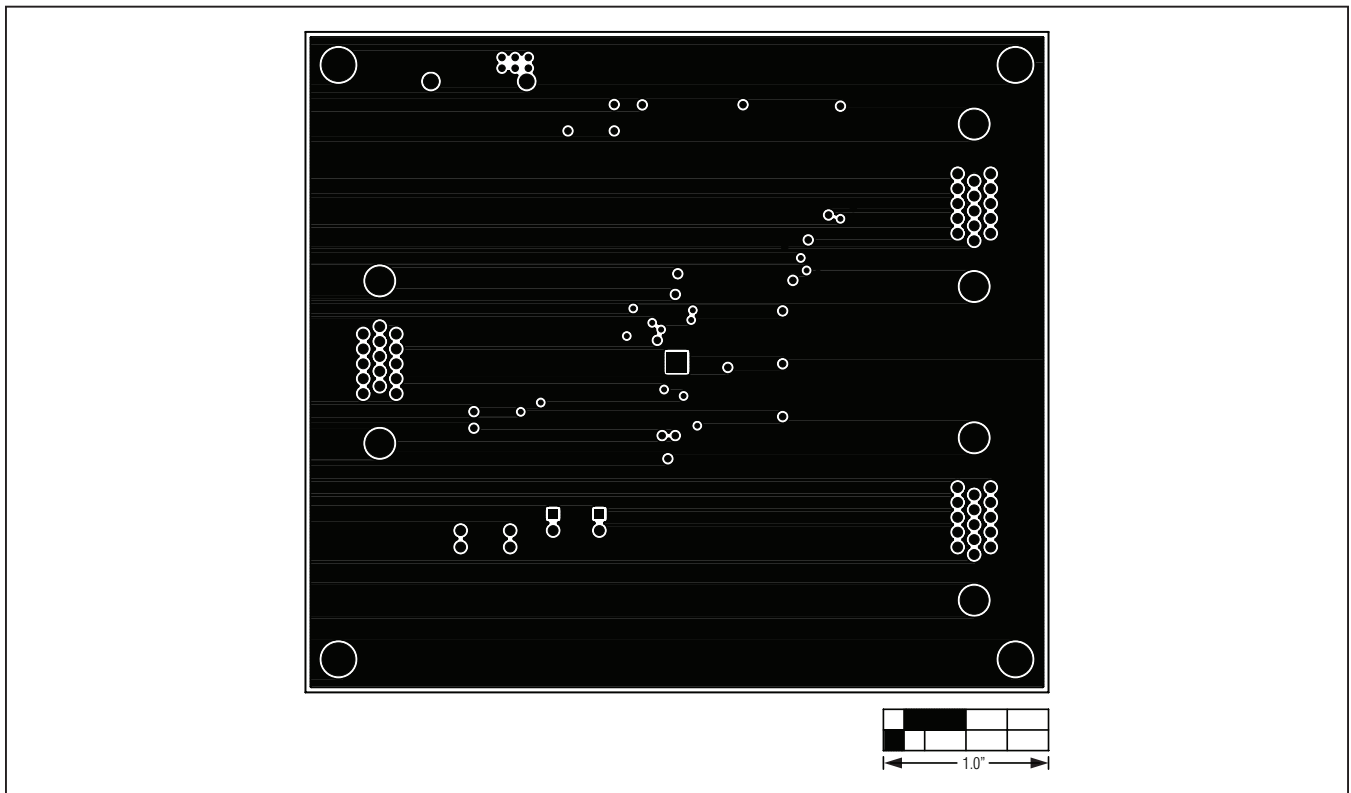

Figure 5. MAX14983E EV Kit PCB Layout—GND Layer 3

# MAX14983E Evaluation Kit

## Evaluates: MAX14983E

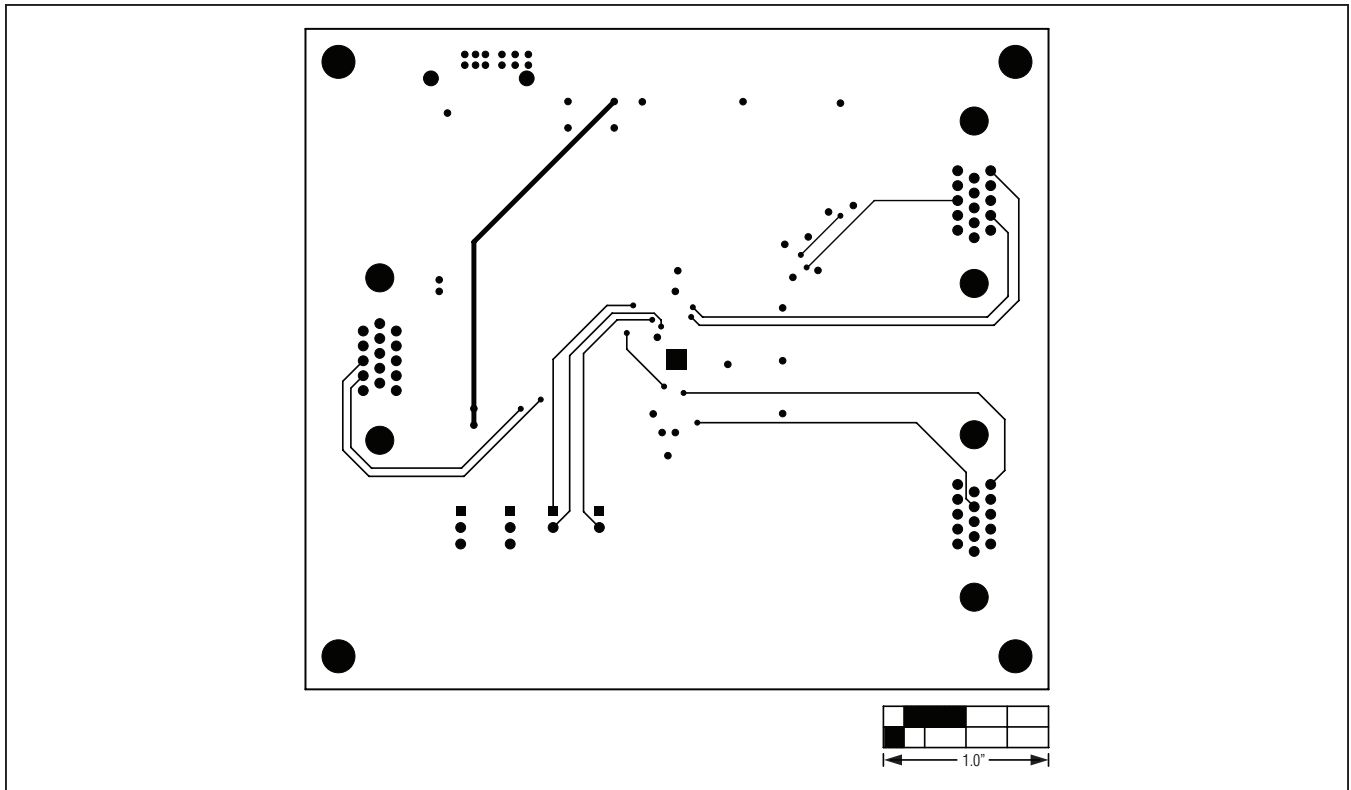

Figure 6. MAX14983E EV Kit PCB Layout—Solder Side

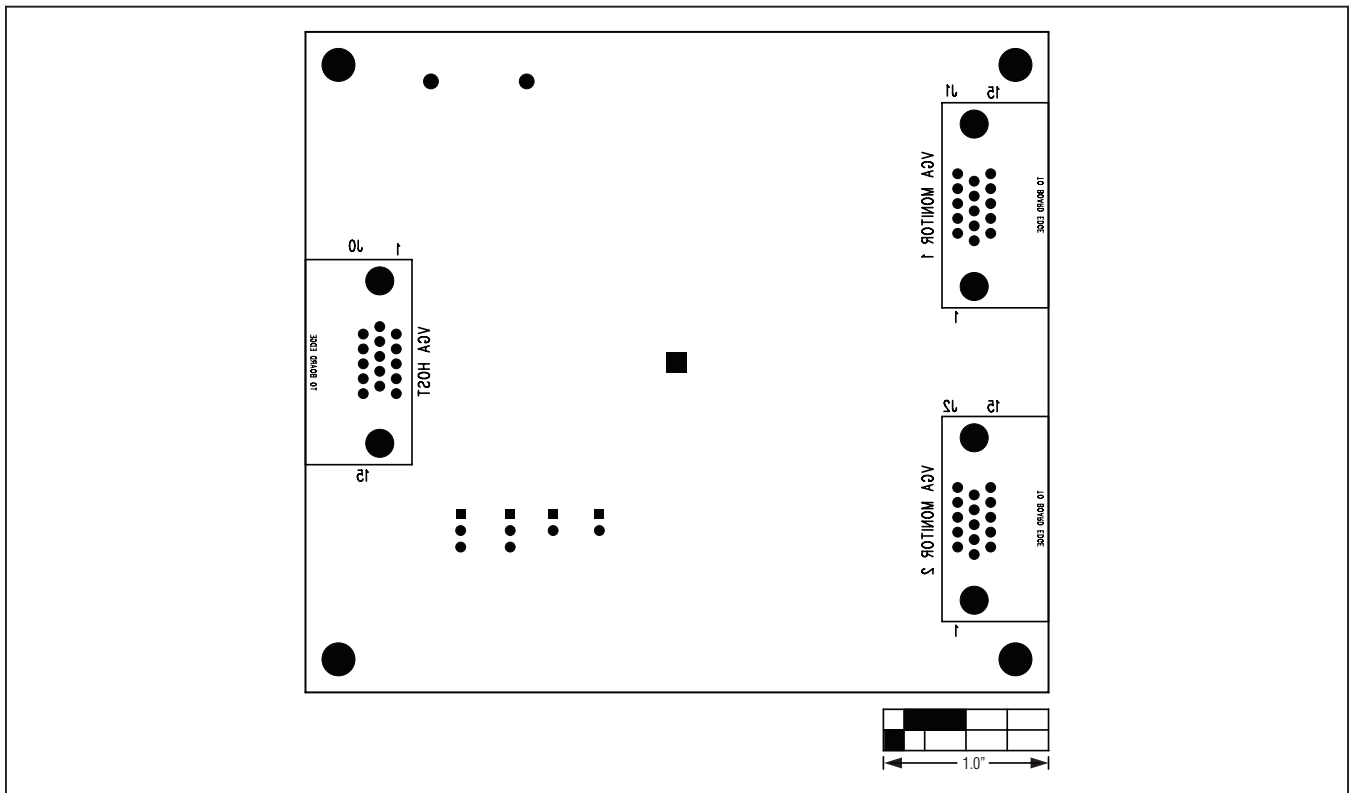

Figure 7. MAX14983E EV Kit Component Placement Guide—Bottom Silkscreen

# MAX14983E Evaluation Kit

## Evaluates: MAX14983E

### ***Ordering Information***

---

<b>PART</b>	<b>TYPE</b>
MAX14983EEVKIT#	EV Kit

*#Denotes RoHS compliant.*

# MAX14983E Evaluation Kit

## Evaluates: MAX14983E

### *Revision History*

REVISION NUMBER	REVISION DATE	DESCRIPTION	PAGES CHANGED
0	11/11	Initial release	—

*Maxim cannot assume responsibility for use of any circuitry other than circuitry entirely embodied in a Maxim product. No circuit patent licenses are implied. Maxim reserves the right to change the circuitry and specifications without notice at any time.*

**Maxim Integrated Products, 120 San Gabriel Drive, Sunnyvale, CA 94086 408-737-7600 \_\_\_\_\_ 8**