

2 Ω, CMOS, ±5 V/+5 V SPST Switches

**FEATURES**

- ▶ Low on resistance, 3.3 Ω maximum
- ▶ <0.8 Ω on-resistance flatness
- ▶ Dual ±2.7 V to ±5.5 V or single +2.7 V to +5.5 V supplies
- ▶ Rail-to-rail input signal range
- ▶ Tiny, 6-lead SOT-23; 8-lead MSOP; and 820 μm × 2255 μm die
- ▶ Low power consumption
- ▶ TTL-/CMOS-compatible inputs

**APPLICATIONS**

- ▶ Automatic test equipment
- ▶ Power routing
- ▶ Communication systems
- ▶ Data acquisition systems
- ▶ Sample-and-hold systems
- ▶ Avionics
- ▶ Relay replacement
- ▶ Battery-powered systems

**GENERAL DESCRIPTION**

The ADG601/ADG602 are monolithic, CMOS single-pole single-throw (SPST) switches with on resistance typically less than 3.3 Ω. The low on-resistance flatness makes the ADG601/ADG602 ideally suited to many applications, particularly those requiring low distortion. These switches are ideal replacements for mechanical relays because they are more reliable, have lower power requirements, and are available in much smaller package sizes.

The ADG601 is a normally open (NO) switch, and the ADG602 is a normally closed (NC) switch. Each switch conducts equally well in both directions when the device is on, with the input signal range extending to the supply rails.

The switches are available in tiny, 6-lead SOT-23; 8-lead MSOP; and 820 μm × 2255 μm die.

**FUNCTIONAL BLOCK DIAGRAMS**

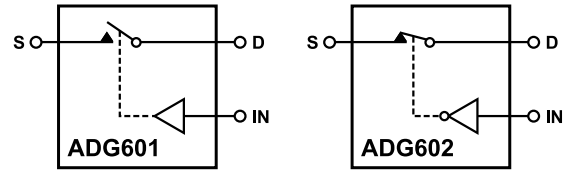

NOTES  
 1. SWITCHES SHOWN FOR A LOGIC 0 INPUT.

001

Figure 1.

Table 1. Truth Table

ADG601 IN	ADG602 IN	Switch Condition
0	1	Off
1	0	On

**PRODUCT HIGHLIGHTS**

1. Low on resistance (2 Ω typical)
2. Dual ±2.7 V to ±5.5 V or single +2.7 V to +5.5 V supplies
3. Tiny, 6-lead SOT-23; 8-lead MSOP; and 820 μm × 2255 μm die
4. Rail-to-rail input signal range

**TABLE OF CONTENTS**

Features.....	1	Absolute Maximum Ratings.....	5
Applications.....	1	ESD Caution.....	5
Functional Block Diagrams.....	1	Pin Configurations and Function Descriptions.....	6
General Description.....	1	Typical Performance Characteristics.....	7
Product Highlights.....	1	Terminology.....	9
Specifications.....	3	Test Circuits.....	10
Dual Supply.....	3	Outline Dimensions.....	12
Single Supply.....	4	Ordering Guide.....	12

**REVISION HISTORY****4/2025—Rev. D to Rev. E**

Changes to Features Section.....	1
Change to General Description Section.....	1
Changes to On Resistance ( $R_{ON}$ ) Parameter and On-Resistance Flatness ( $R_{FLAT(ON)}$ ) Parameter, Table 2.....	3
Changes to On Resistance ( $R_{ON}$ ) Parameter and On-Resistance Flatness ( $R_{FLAT(ON)}$ ) Parameter, Table 3.....	4

## SPECIFICATIONS

## DUAL SUPPLY

$V_{DD} = 5\text{ V} \pm 10\%$ ,  $V_{SS} = -5\text{ V} \pm 10\%$ ,  $GND = 0\text{ V}$ , unless otherwise noted.

Table 2.

Parameter	B Version <sup>1</sup>		Unit	Test Conditions/Comments
	+25°C	-40°C to +85°C		
<b>ANALOG SWITCH</b>				
Analog Signal Range		$V_{SS}$ to $V_{DD}$	V	$V_{DD} = +4.5\text{ V}$ , $V_{SS} = -4.5\text{ V}$
On Resistance ( $R_{ON}$ )	2		$\Omega$ typ	$V_S = \pm 4.5\text{ V}$ , $I_{DS} = -10\text{ mA}$ ; see <a href="#">Figure 15</a>
	3.3	5.5	$\Omega$ max	
On-Resistance Flatness ( $R_{FLAT(ON)}$ )	0.35	0.4	$\Omega$ typ	$V_S = \pm 3.3\text{ V}$ , $I_{DS} = -10\text{ mA}$
	0.75	0.8	$\Omega$ max	
<b>LEAKAGE CURRENTS</b>				
Source Off Leakage, $I_S$ (Off)	$\pm 0.01$		nA typ	$V_{DD} = +5.5\text{ V}$ , $V_{SS} = -5.5\text{ V}$
	$\pm 0.25$	$\pm 1$	nA max	$V_S = +4.5\text{ V}/-4.5\text{ V}$ , $V_D = -4.5\text{ V}/+4.5\text{ V}$ ; see <a href="#">Figure 16</a>
Drain Off Leakage, $I_D$ (Off)	$\pm 0.01$		nA typ	$V_S = +4.5\text{ V}/-4.5\text{ V}$ , $V_D = -4.5\text{ V}/+4.5\text{ V}$ ; see <a href="#">Figure 16</a>
	$\pm 0.25$	$\pm 1$	nA max	
Channel On Leakage, $I_D$ , $I_S$ (On)	$\pm 0.01$		nA typ	$V_S = V_D = +4.5\text{ V}$ or $-4.5\text{ V}$ ; see <a href="#">Figure 17</a>
	$\pm 0.25$	$\pm 1$	nA max	
<b>DIGITAL INPUTS</b>				
Input High Voltage, $V_{INH}$		2.4	V min	
Input Low Voltage, $V_{INL}$		0.8	V max	
Input Current, $I_{INL}$ or $I_{INH}$	0.005		$\mu\text{A}$ typ	$V_{IN} = V_{INL}$ or $V_{INH}$
		$\pm 0.1$	$\mu\text{A}$ max	
Digital Input Capacitance, $C_{IN}$	2		pF typ	
<b>DYNAMIC CHARACTERISTICS<sup>2</sup></b>				
$t_{ON}$	80		ns typ	$R_L = 300\ \Omega$ , $C_L = 35\text{ pF}$
	120	155	ns max	$V_S = 3.3\text{ V}$ ; see <a href="#">Figure 18</a>
$t_{OFF}$	45		ns typ	$R_L = 300\ \Omega$ , $C_L = 35\text{ pF}$
	75	90	ns max	$V_S = 3.3\text{ V}$ ; see <a href="#">Figure 18</a>
Charge Injection	250		pC typ	$V_S = 0\text{ V}$ , $R_S = 0\ \Omega$ , $C_L = 1\text{ nF}$ ; see <a href="#">Figure 19</a>
Off Isolation	-60		dB typ	$R_L = 50\ \Omega$ , $C_L = 5\text{ pF}$ , $f = 1\text{ MHz}$ ; see <a href="#">Figure 20</a>
Bandwidth -3 dB	180		MHz typ	$R_L = 50\ \Omega$ , $C_L = 5\text{ pF}$ ; see <a href="#">Figure 21</a>
$C_S$ (Off)	50		pF typ	$f = 1\text{ MHz}$
$C_D$ (Off)	50		pF typ	$f = 1\text{ MHz}$
$C_D$ , $C_S$ (On)	145		pF typ	$f = 1\text{ MHz}$
<b>POWER REQUIREMENTS</b>				
$I_{DD}$	0.001		$\mu\text{A}$ typ	$V_{DD} = +5.5\text{ V}$ , $V_{SS} = -5.5\text{ V}$
		1.0	$\mu\text{A}$ max	Digital inputs = 0 V or 5.5 V
$I_{SS}$	0.001		$\mu\text{A}$ typ	Digital inputs = 0 V or 5.5 V
		1.0	$\mu\text{A}$ max	

<sup>1</sup> Temperature range for B version is -40°C to +85°C.

<sup>2</sup> Guaranteed by design, not subject to production test.

## SPECIFICATIONS

## SINGLE SUPPLY

$V_{DD} = 5\text{ V} \pm 10\%$ ,  $V_{SS} = 0\text{ V}$ ,  $GND = 0\text{ V}$ , unless otherwise noted.

Table 3.

Parameter	B Version <sup>1</sup>		Unit	Test Conditions/Comments
	+25°C	-40°C to +85°C		
<b>ANALOG SWITCH</b>				
Analog Signal Range		0 V to $V_{DD}$	V	$V_{DD} = 4.5\text{ V}$
On Resistance ( $R_{ON}$ )	3.5		$\Omega$ typ	$V_S = 0\text{ V to }4.5\text{ V}$ , $I_{DS} = -10\text{ mA}$ ; see <a href="#">Figure 15</a>
	5.5	8	$\Omega$ max	
On-Resistance Flatness ( $R_{FLAT(ON)}$ )	0.2	0.2	$\Omega$ typ	$V_S = 1.5\text{ V to }3.3\text{ V}$ , $I_{DS} = -10\text{ mA}$
		0.75	$\Omega$ max	
<b>LEAKAGE CURRENTS</b>				
Source Off Leakage, $I_S$ (Off)	$\pm 0.01$		nA typ	$V_{DD} = 5.5\text{ V}$ $V_S = 4.5\text{ V}/1\text{ V}$ , $V_D = 1\text{ V}/4.5\text{ V}$ ; see <a href="#">Figure 16</a>
	$\pm 0.25$	$\pm 1$	nA max	
Drain Off Leakage, $I_D$ (Off)	$\pm 0.01$		nA typ	$V_S = 4.5\text{ V}/1\text{ V}$ , $V_D = 1\text{ V}/4.5\text{ V}$ ; see <a href="#">Figure 16</a>
	$\pm 0.25$	$\pm 1$	nA max	
Channel On Leakage, $I_D$ , $I_S$ (On)	$\pm 0.01$		nA typ	$V_S = V_D = 4.5\text{ V or }1\text{ V}$ ; see <a href="#">Figure 17</a>
	$\pm 0.25$	$\pm 1$	nA max	
<b>DIGITAL INPUTS</b>				
Input High Voltage, $V_{INH}$		2.4	V min	
Input Low Voltage, $V_{INL}$		0.8	V max	
Input Current, $I_{INL}$ or $I_{INH}$	0.005		$\mu\text{A}$ typ	$V_{IN} = V_{INL}$ or $V_{INH}$
		$\pm 0.1$	$\mu\text{A}$ max	
Digital Input Capacitance, $C_{IN}$	2		pF typ	
<b>DYNAMIC CHARACTERISTICS<sup>2</sup></b>				
$t_{ON}$	110		ns typ	$R_L = 300\ \Omega$ , $C_L = 35\text{ pF}$
	220	280	ns max	$V_S = 3.3\text{ V}$ ; see <a href="#">Figure 18</a>
$t_{OFF}$	50		ns typ	$R_L = 300\ \Omega$ , $C_L = 35\text{ pF}$
	80	110	ns max	$V_S = 3.3\text{ V}$ ; see <a href="#">Figure 18</a>
Charge Injection	20		pC typ	$V_S = 0\text{ V}$ , $R_S = 0\ \Omega$ , $C_L = 1\text{ nF}$ ; see <a href="#">Figure 19</a>
Off Isolation	-60		dB typ	$R_L = 50\ \Omega$ , $C_L = 5\text{ pF}$ , $f = 1\text{ MHz}$ ; see <a href="#">Figure 20</a>
Bandwidth -3 dB	180		MHz typ	$R_L = 50\ \Omega$ , $C_L = 5\text{ pF}$ ; see <a href="#">Figure 21</a>
$C_S$ (Off)	50		pF typ	$f = 1\text{ MHz}$
$C_D$ (Off)	50		pF typ	$f = 1\text{ MHz}$
$C_D$ , $C_S$ (On)	145		pF typ	$f = 1\text{ MHz}$
<b>POWER REQUIREMENTS</b>				
$I_{DD}$	0.001		$\mu\text{A}$ typ	$V_{DD} = 5.5\text{ V}$ Digital inputs = 0 V or 5.5 V
		1.0	$\mu\text{A}$ max	

<sup>1</sup> Temperature range for B version is -40°C to +85°C.

<sup>2</sup> Guaranteed by design, not subject to production test.

**ABSOLUTE MAXIMUM RATINGS**

$T_A = 25^\circ\text{C}$ , unless otherwise noted.

**Table 4.**

Parameter	Rating
$V_{DD}$ to $V_{SS}$	13 V
$V_{DD}$ to GND	-0.3 V to +6.5 V
$V_{SS}$ to GND	+0.3 V to -6.5 V
Analog Inputs <sup>1</sup>	$V_{SS} - 0.3$ V to $V_{DD} + 0.3$ V
Digital Inputs <sup>1</sup>	-0.3 V to $V_{DD} + 0.3$ V or 30 mA (whichever occurs first)
Continuous Current, S or D	100 mA
Peak Current, S or D (Pulsed at 1 ms, 10% Duty Cycle Max)	200 mA
Operating Temperature Range	
Industrial (B Version)	-40°C to +85°C
Storage Temperature Range	-65°C to +150°C
Junction Temperature	150°C
Thermal Resistance	
MSOP	
$\theta_{JA}$	206°C/W
$\theta_{JC}$	44°C/W
SOT-23	
$\theta_{JA}$	229.6°C/W
$\theta_{JC}$	91.99°C/W
Lead Temperature, Soldering (10 sec)	300°C
IR Reflow, Peak Temperature	260°C

<sup>1</sup> Overvoltages at IN, S, or D are clamped by internal diodes. Current should be limited to the maximum ratings given.

Stresses at or above those listed under Absolute Maximum Ratings may cause permanent damage to the product. This is a stress rating only; functional operation of the product at these or any other conditions above those indicated in the operational section of this specification is not implied. Operation beyond the maximum operating conditions for extended periods may affect product reliability.

Only one absolute maximum rating may be applied at a time.

**ESD CAUTION**

**ESD (electrostatic discharge) sensitive device.** Charged devices and circuit boards can discharge without detection. Although this product features patented or proprietary protection circuitry, damage may occur on devices subjected to high energy ESD. Therefore, proper ESD precautions should be taken to avoid performance degradation or loss of functionality.

PIN CONFIGURATIONS AND FUNCTION DESCRIPTIONS

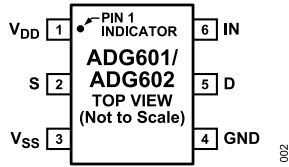

Figure 2. 6-Lead SOT-23 (RJ-6)

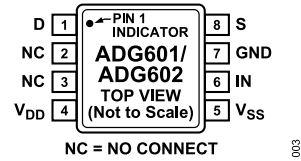

Figure 3. 8-Lead MSOP (RM-8)

Table 5. Pin Function Descriptions

Pin No.		Mnemonic	Description
6-Lead SOT-23	8-Lead MSOP		
1	4	V <sub>DD</sub>	Most Positive Power Supply Potential.
2	8	S	Source Terminal. Can be an input or output.
3	5	V <sub>SS</sub>	Most Negative Power Supply Potential.
4	7	GND	Ground (0 V) Reference.
5	1	D	Drain Terminal. Can be an input or output.
6	6	IN	Logic Control Input.
N/A <sup>1</sup>	2, 3	NC	No Connect.

<sup>1</sup> N/A is not applicable.

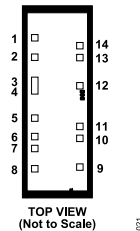

Figure 4. Die (820 μm × 2255 μm)

Table 6. Die Pad Coordinates<sup>1</sup>

Die Pad No.	Die Pad Coordinates		Mnemonic	Description
	X (μm)	Y (μm)		
1	-265	+754	NC	No Connect.
2	-265	+525	D	Drain Terminal. Can be an input or output. <sup>2</sup>
3	-265	+241	D	Drain Terminal. Can be an input or output. <sup>2</sup>
4	-265	+141	D	Drain Terminal. Can be an input or output. <sup>2</sup>
5	-265	-191	NC	No Connect.
6	-265	-409	NC	No Connect.
7	-265	-549	NC	No Connect.
8	-265	-787	V <sub>DD</sub>	Most Positive Power Supply Potential.
9	+265	-767	V <sub>SS</sub>	Most Negative Power Supply Potential.
10	+265	-429	IN	Logic Control Input.
11	+265	-289	GND	Ground (0 V) Reference.
12	+265	+189	S	Source Terminal. Can be an input or output. <sup>3</sup>
13	+265	+521	S	Source Terminal. Can be an input or output. <sup>3</sup>
14	+265	+661	NC	Source Terminal. Can be an input or output.

<sup>1</sup> Measured from the center of the die.

<sup>2</sup> Bond the D pads together to a single point to preserve the on resistance and current handling capability. The common point acts as the drain pin of the switch.

<sup>3</sup> Bond the S pads together to a single point to preserve the on resistance and current handling capability. The common point acts as the source pin of the switch.

TYPICAL PERFORMANCE CHARACTERISTICS

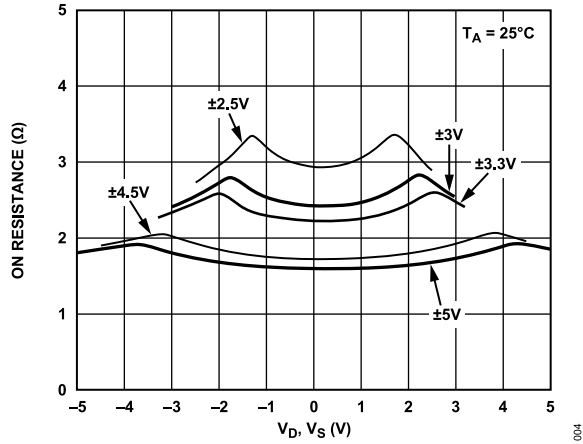

Figure 5. On Resistance vs.  $V_D$ ,  $V_S$  (Dual Supply)

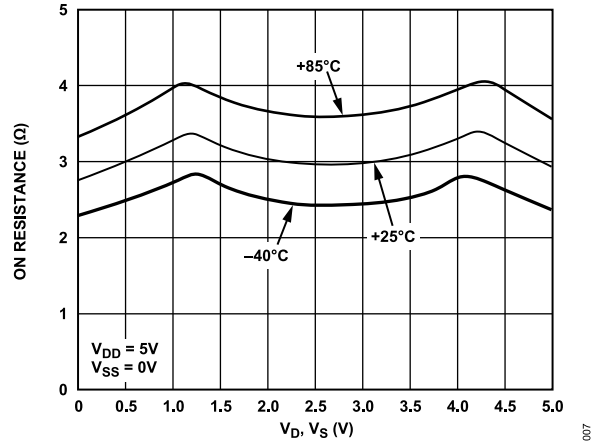

Figure 8. On Resistance vs.  $V_D$ ,  $V_S$  for Different Temperatures (Single Supply)

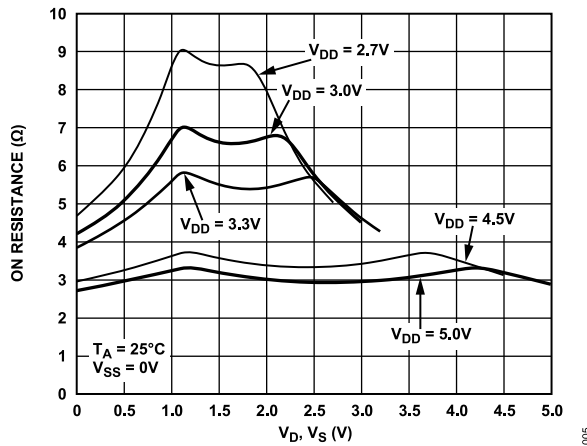

Figure 6. On Resistance vs.  $V_D$ ,  $V_S$  (Single Supply)

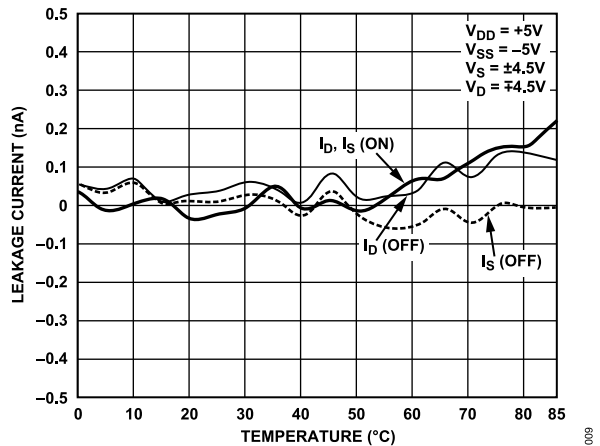

Figure 9. Leakage Currents vs. Temperature (Dual Supply)

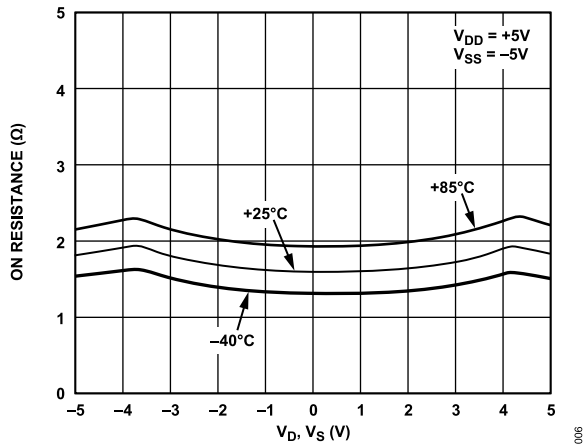

Figure 7. On Resistance vs.  $V_D$ ,  $V_S$  for Different Temperatures (Dual Supply)

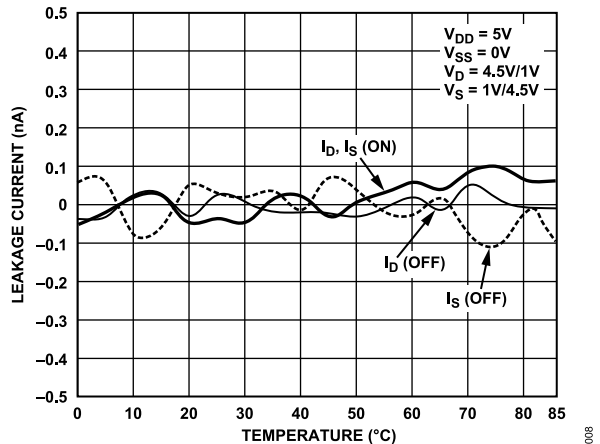

Figure 10. Leakage Currents vs. Temperature (Single Supply)

TYPICAL PERFORMANCE CHARACTERISTICS

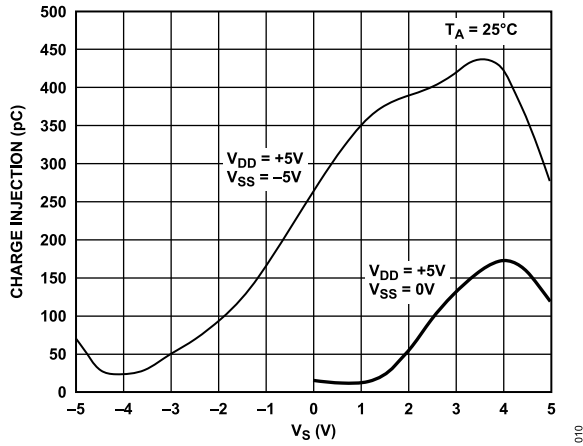

Figure 11. Charge Injection vs. Source Voltage

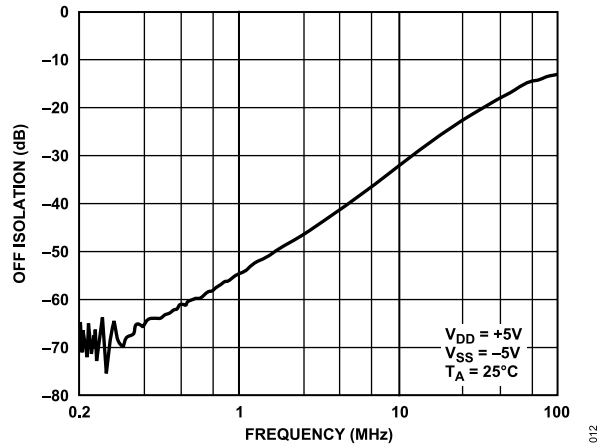

Figure 13. Off Isolation vs. Frequency

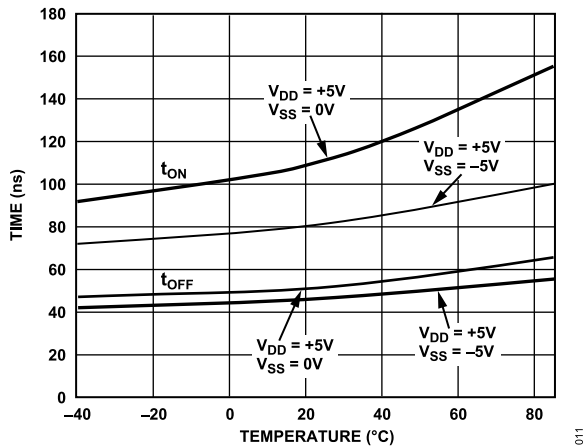

Figure 12.  $t_{ON}/t_{OFF}$  Times vs. Temperature

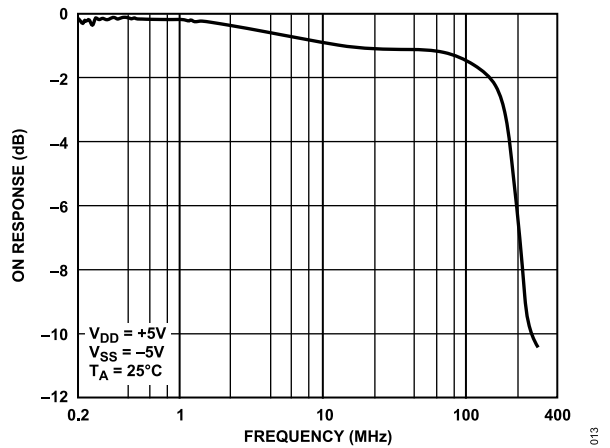

Figure 14. On Response vs. Frequency



**TERMINOLOGY****V<sub>DD</sub>**

Most positive power supply potential.

**V<sub>SS</sub>**

Most negative power supply potential.

**I<sub>DD</sub>**

Positive supply current.

**I<sub>SS</sub>**

Negative supply current.

**GND**

Ground (0 V) reference.

**S**

Source terminal. Can be an input or an output.

**D**

Drain terminal. Can be an input or an output.

**IN**

Logic control input.

**V<sub>D</sub>, V<sub>S</sub>**

Analog voltage on Terminal D and Terminal S.

**R<sub>ON</sub>**

Ohmic resistance between Terminal D and Terminal S.

**R<sub>FLAT (ON)</sub>**

Flatness is defined as the difference between the maximum and minimum values of on resistance as measured over the specified analog signal range.

**I<sub>S (Off)</sub>**

Source leakage current with the switch off.

**I<sub>D (Off)</sub>**

Drain leakage current with the switch off.

**I<sub>D</sub>, I<sub>S (On)</sub>**

Channel leakage current with the switch on.

**V<sub>INL</sub>**

Maximum input voltage for Logic 0.

**V<sub>INH</sub>**

Minimum input voltage for Logic 1.

**I<sub>INL</sub>, I<sub>INH</sub>**

Input current of the digital input.

**C<sub>S (Off)</sub>**

Off switch source capacitance. Measured with reference to ground.

**C<sub>D (Off)</sub>**

Off switch drain capacitance. Measured with reference to ground.

**C<sub>D</sub>, C<sub>S (On)</sub>**

On switch capacitance. Measured with reference to ground.

**C<sub>IN</sub>**

Digital input capacitance.

**t<sub>ON</sub>**

Delay between applying the digital control input and the output switching on.

**t<sub>OFF</sub>**

Delay between applying the digital control input and the output switching off.

**Charge Injection**

A measure of the glitch impulse transferred from the digital input to the analog output during switching.

**Off Isolation**

A measure of unwanted signal coupling through an off switch.

**On Response**

Frequency response of the on switch.

**Insertion Loss**

Loss due to the on resistance of the switch.

TEST CIRCUITS

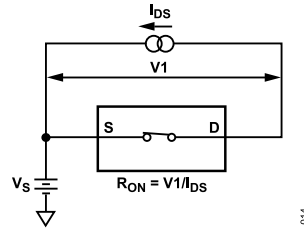

Figure 15. On Resistance

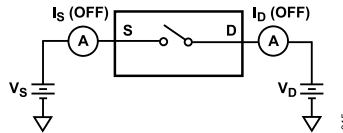

Figure 16. Off Leakage

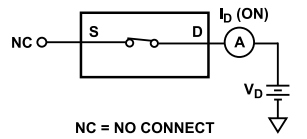

Figure 17. On Leakage

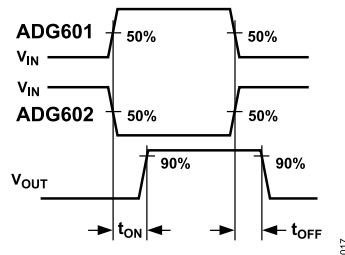
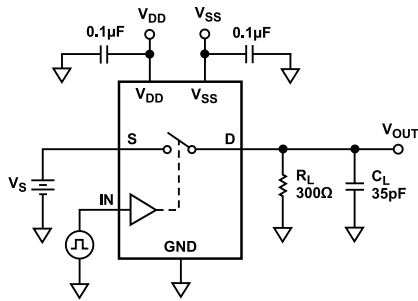

Figure 18. Switching Times

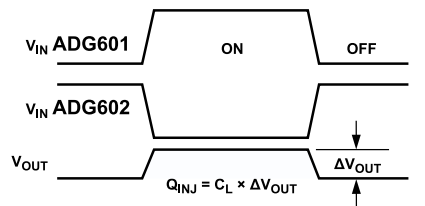
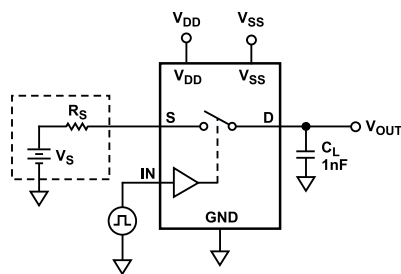

Figure 19. Charge Injection

TEST CIRCUITS

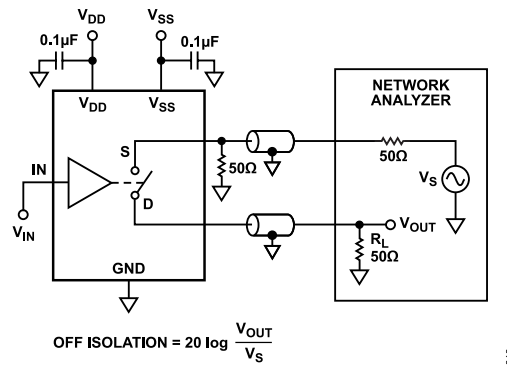

Figure 20. Off Isolation

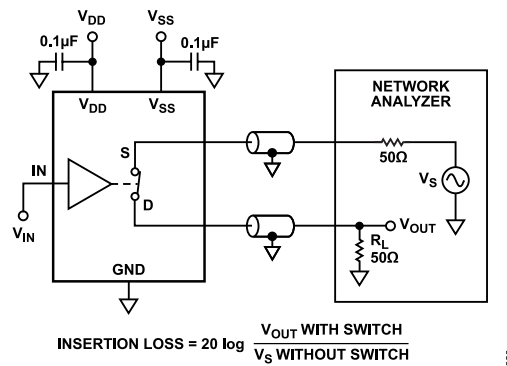

Figure 21. Bandwidth

## OUTLINE DIMENSIONS

Package Drawing (Option)	Package Type	Package Description
RM-8	MSOP	8-Lead Mini Small Outline Package
RJ-6	SOT-23	6-Lead Small Outline Transistor Package

For the latest package outline information and land patterns (footprints), go to [Package Index](#).

## ORDERING GUIDE

Model <sup>1</sup>	Temperature Range	Package Description	Packing Quantity	Package Option	Marking Code <sup>2</sup>
ADG601BRTZ-REEL	-40°C to +85°C	6-Lead SOT-23	Reel, 10000	RJ-6	STB#
ADG601BRTZ-REEL7	-40°C to +85°C	6-Lead SOT-23	Reel, 3000	RJ-6	STB#
ADG601BRMZ	-40°C to +85°C	8-Lead MSOP	Tube, 50	RM-8	S1G
ADG601BRMZ-REEL7	-40°C to +85°C	8-Lead MSOP	Reel, 1000	RM-8	S1G
ADG601C-PT7		Die	Tape, 3000		
ADG602BRTZ-REEL7	-40°C to +85°C	6-Lead SOT-23	Reel, 3000	RJ-6	S18
ADG602BRMZ	-40°C to +85°C	8-Lead MSOP	Tube, 50	RM-8	S18
ADG602BRMZ-REEL7	-40°C to +85°C	8-Lead MSOP	Reel, 1000	RM-8	S18

<sup>1</sup> Z = RoHS Compliant Part, # denotes RoHS compliant product, may be top or bottom marked.

<sup>2</sup> Marking code on SOT-23 and MSOP is limited to three characters due to space constraints.