

DESIGN NOTES

A Simple High Efficiency, Step-Down Switching Regulator

Design Note 73

San-Hwa Chee

The new LTC[®]1174 requires only 4 external components to construct a complete high efficiency step-down regulator. Using Burst Mode[®] operation, efficiency of 90% is achievable at output currents as low as 10mA. The LTC1174 is protected against output shorts by an internal current limit which is pin selectable to either 340mA or 600mA. This current limit also sets the inductor's peak current. This allows the user to optimize the converter's efficiency depending upon the output current requirement.

To help the user get the most out of their battery source, the internal 0.9Ω (at supply voltage of 9V) power P-channel MOSFET switch is turned on continuously (DC) at dropout. In addition, an active low shutdown pin is included to power down the LTC1174, reducing the no load quiescent current from 130μA to just 1μA. An on-chip low battery detector is also included, with the trip point set by two external resistors.

Figure 1 shows a typical LTC1174 surface mount application. It provides 5V at 175mA from an input voltage range of 5.5V to 12.5V. Figure 2 shows the circuit's efficiency approaching 93% at an input voltage of 9V. Peak inductor current is limited to 340mA by connecting Pin 7 (I_{PGM}) to ground. The advantages of controlling the inductor's current include: excellent line and load transient response, short-circuit protection and controlled start-up current.

For applications requiring higher output current, connect Pin 7 (I_{PGM}) to V_{IN}. Under this condition, the maximum

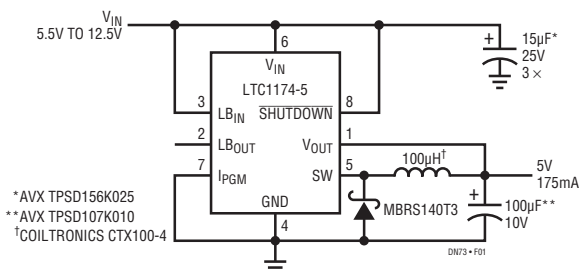

Figure 1. LTC1174 5V, 175mA Surface Mount

load current is increased to 425mA. Figure 3 shows the resulting circuit. Note that all components remain the same as in Figure 1. The new efficiency curve is shown in Figure 4.

LT, LT, LTC, LTM, Linear Technology, the Linear logo and Burst Mode are registered trademarks of Linear Technology Corporation. All other trademarks are the property of their respective owners.

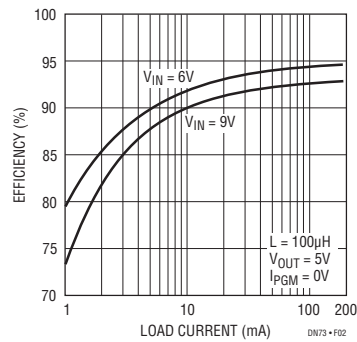

Figure 2. LTC1174 5V, 175mA Efficiency

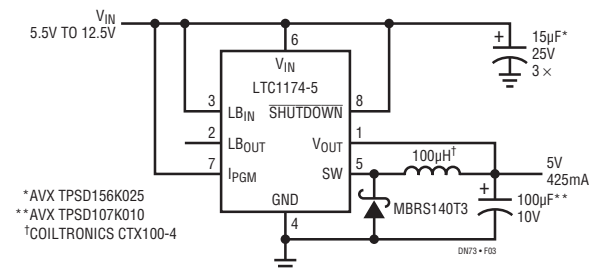

Figure 3. LTC1174 5V, 425mA Surface Mount

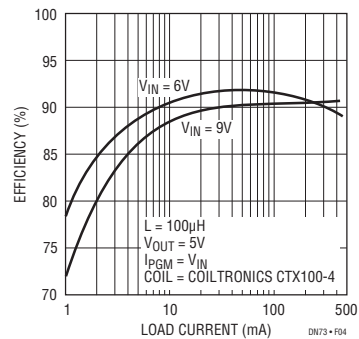

Figure 4. LTC1174 5V, 425mA Efficiency

To have good control of inductor ripple current, a constant off-time architecture is used for the LTC1174. This scheme allows the ripple current to remain constant while the input voltage varies, easing the inductor's selection. However, the switching frequency is a function of input voltage. For an input voltage range of 6V to 12V with an output voltage of 5V, the operating frequency varies from about 42kHz to 146kHz. Figure 5 shows a normalized plot of the switching frequency as a function of the differential input/output voltage. The normalized value of 1 is equivalent to 111kHz.

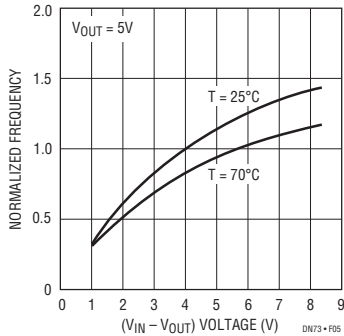

Figure 5. Operating Frequency vs $V_{IN} - V_{OUT}$

100% Duty Cycle in Dropout

When the input voltage decreases, the switching frequency decreases. With the off-time constant, the on-time is increased to maintain the same peak-to-peak ripple current in the inductor. Ultimately, a steady-state condition will be reached where Kirchoff's Voltage Law determines the dropout voltage. When this happens, the P-channel power MOSFET is turned on DC (100% duty cycle). The dropout voltage is then governed by the load current multiplied by the total DC resistance of the MOSFET, inductor, and the internal 0.1Ω current sense resistance. Figure 6 shows the dropout voltage as a function of load current.

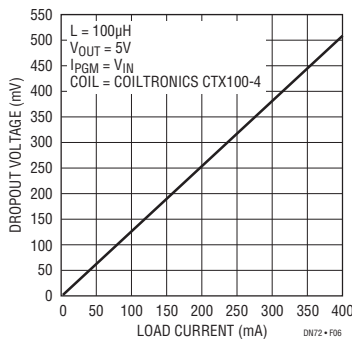

Figure 6. Dropout Voltage vs Output Current

Positive-to-Negative Converter

The LTC1174 can easily be set up for a negative output voltage. If $-5V$ is desired, the LTC1174-5 is ideal for this application as it requires the least components. Figure 7 shows the schematic for this application including low battery detection capability. The LED will turn on at input voltages less than $4.9V$. The corresponding efficiency curve is shown in Figure 8.

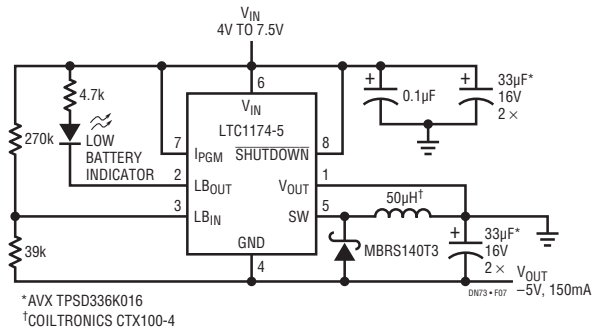

Figure 7. Positive to $-5V$ Converter with Low Battery Detection

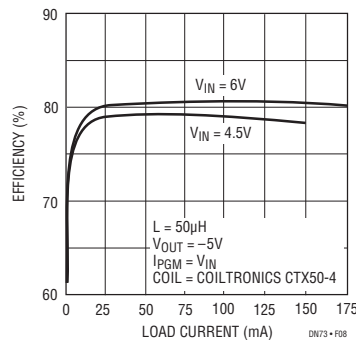

Figure 8. Efficiency vs Load Current for a $-5V$ Output Regulator

Data Sheet Download

www.linear.com

For applications help,
call (408) 432-1900