



***Total Ionizing Dose (TID) Radiation Testing of the RH1078MJ8 Dual Precision Op Amp for Linear Technology***

**Customer:** Linear Technology, PO# 54873L

**RAD Job Number:** 10-004

**Part Type Tested:** Linear Technology RH1078MJ8 Dual Precision Operational Amplifier

**Commercial Part Number:** RH1078MJ8

**Traceability Information:** Lot Date Code: 0939A, Assy Lot# 540915.1, Fab Lot# W0933494.1, Wafer 12 (Obtained from Linear Technology PO 54873L). See photograph of unit under test in Appendix A.

**Quantity of Units:** 12 units total, 5 units for biased irradiation, 5 units for unbiased irradiation and 2 control units. Serial numbers 255, 258, 309, 359, and 360 were biased during irradiation, serial numbers 416, 472, 473, 526, and 529 were unbiased during irradiation and serial numbers 530 and 561 were used as controls. See Appendix B for the radiation bias connection table.

**Pre-Irradiation Burn-In:** Burn-In performed by Linear Technology prior to receipt by RAD.

**TID Dose Rate and Test Increments:** 50-300rad(Si)/s with readings at pre-irradiation, 10, 20, 30 and 50krad(Si).

**TID Overtest and Post-Irradiation Anneal:** No overtest. 24-hour room temperature anneal followed by a 168-hour 100°C anneal. Both anneals shall be performed in the same electrical bias condition as the irradiations. Electrical measurements shall be made following each anneal increment.

**TID Test Standard:** MIL-STD-883G, Method 1019.7, Condition A

**TID Electrical Test Conditions:** Pre-irradiation, and within one hour following each radiation exposure.

**Test Hardware and Software:** LTS2020 Tester, 2101 Family Board, 0600 Fixture, RH1078 DUT Board, and RH1078LT.SRC test program.

**Facility and Radiation Source:** Radiation Assured Devices Longmire Laboratories, Colorado Springs, CO using the JLSA 81-24 high dose rate Co60 source. Dosimetry performed by CaF<sub>2</sub> TLDs traceable to NIST. RAD's dosimetry has been audited by DSCC and RAD has been awarded Laboratory Suitability for MIL-STD-750 TM 1019.5.

**Irradiation and Test Temperature:** Room temperature for irradiation and test controlled to 24°C ± 6°C per MIL-STD-883.

**Total Ionizing Dose Test Result: PASSED. Units passed to the maximum tested total dose of 50krad(Si) with no significant degradation observed to any measured parameter. Further, the units do not exhibit ELDRS as defined in the current test method.**



## **1.0. Overview and Background**

It is well known that total dose ionizing radiation can cause parametric degradation and ultimately functional failure in electronic devices. The damage occurs via electron-hole pair production, transport and trapping in the dielectric and interface regions. In discrete devices the bulk of the damage is frequently manifested as a reduction in the gain and/or breakdown voltage of the device. The damage will usually anneal with time following the end of the radiation exposure. Due to this annealing, and to ensure a worst-case test condition MIL-STD-883 TM1019.7 calls out a dose rate of 50 to 300rad(Si)/s as Condition A and further specifies that the time from the end of an incremental radiation exposure and electrical testing shall be 1-hour or less and the total time from the end of one incremental irradiation to the beginning of the next incremental radiation step should be 2-hours or less. The work described in this report was performed to meet MIL-STD-883 TM1019.7 Condition A.

## **2.0. Radiation Test Apparatus**

The total ionizing dose testing described in this final report was performed using the facilities at Radiation Assured Devices' Longmire Laboratories in Colorado Springs, CO. The high dose rate total ionizing dose (TID) source is a JLSA 84-21 irradiator modified to provide a panoramic exposure. The Co-60 rods are held in the base of the irradiator heavily shielded by lead, during the radiation exposures the rod is raised by an electronic timer/controller and the exposure is performed in air. The dose rate for this irradiator in this configuration ranges from <1rad(Si)/s to a maximum of approximately 120rad(Si)/s, determined by the distance from the source. For high-dose rate experiments the bias boards are placed in a radial fashion equidistant from the raised Co-60 rods with the distance adjusted to provide the required dose rate. The irradiator calibration is maintained by Radiation Assured Devices Longmire Laboratories using thermoluminescent dosimeters (TLDs) traceable to the National Institute of Standards and Technology (NIST). Figure 2.1 shows a photograph of the JLSA 81-24 Co-60 irradiator at RAD's Longmire Laboratory facility.

RAD is currently certified by the Defense Supply Center Columbus (DSCC) for Laboratory Suitability under MIL-STD-750 and MIL-STD-883. Additional details regarding Radiation Assured Devices dosimetry for TM1019 Condition A testing are available in RAD's report to DSCC entitled: "Dose Rate Mapping of the J.L. Shepherd and Associates Model 81 Irradiator Installed by Radiation Assured Devices"



Figure 2.1. Radiation Assured Devices' high dose rate Co-60 irradiator. The dose rate is obtained by positioning the device-under-test at a fixed distance from the gamma cell. The dose rate for this irradiator varies from approximately 120rad(Si)/s close to the rods down to 1rad(Si)/s at a distance of approximately 2-feet.



### **3.0. Radiation Test Conditions**

The RH1078MJ8 Dual Precision Op Amp described in this final report was irradiated using a split 15V supply and with all pins tied to ground, that is biased and unbiased. See the TID Bias Table in Appendix A for the full bias circuits. In our opinion these bias circuits satisfy the requirements of MIL-STD-883G TM1019.7 Section 3.9.3 Bias and Loading Conditions which states “The bias applied to the test devices shall be selected to produce the greatest radiation induced damage or the worst-case damage for the intended application, if known. While maximum voltage is often worst case some bipolar linear device parameters (e.g. input bias current or maximum output load current) exhibit more degradation with 0 V bias.”

The devices were irradiated to a maximum total ionizing dose level of 50krad(Si) with incremental readings at 10, 20, 30 and 50krad(Si). Electrical testing occurred within one hour following the end of each irradiation segment. For intermediate irradiations, the units were tested and returned to total dose exposure within two hours from the end of the previous radiation increment. The TID bias board was positioned in the Co-60 cell to provide the required minimum dose rate of 50rad(Si)/s and was located inside a lead-aluminum enclosure. The lead-aluminum enclosure is required under MIL-STD-883G TM1019.7 Section 3.4 that reads as follows: “Lead/Aluminum (Pb/Al) container. Test specimens shall be enclosed in a Pb/Al container to minimize dose enhancement effects caused by low-energy, scattered radiation. A minimum of 1.5 mm Pb, surrounding an inner shield of at least 0.7 mm Al, is required. This Pb/Al container produces an approximate charged particle equilibrium for Si and for TLDs such as CaF<sub>2</sub>. The radiation field intensity shall be measured inside the Pb/Al container (1) initially, (2) when the source is changed, or (3) when the orientation or configuration of the source, container, or test-fixture is changed. This measurement shall be performed by placing a dosimeter (e.g., a TLD) in the device-irradiation container at the approximate test-device position. If it can be demonstrated that low energy scattered radiation is small enough that it will not cause dosimetry errors due to dose enhancement, the Pb/Al container may be omitted”.

The final dose rate within the lead-aluminum box was determined based on TLD dosimetry measurements just prior to the beginning of the total dose irradiations. The final dose rate for this work was 55.3rad(Si)/s with a precision of  $\pm 5\%$ .

During the total ionizing dose testing the following electrical parameters were measured pre- and post-irradiation:

#### **$\pm 15V$ Tests**

1. Positive Supply Current (ICC2)
2. Negative Supply Current (IEE2)
3. Input Offset Voltage (VOS3 & VOS4)
4. Input Offset Current (IOS3 & IOS4)
5. + Input Bias Current (IB+3 & IB+4)



6. - Input Bias Current (IB-3 & IB-4)
7. Common Mode Rejection Ratio (CMRR3 & CMRR4)
8. Power Supply Rejection Ratio (PSRR3 & PSRR4)
9. Large Signal Voltage Gain (AVOL 5 & AVOL6)
10. Large Signal Voltage Gain (AVOL 7 & AVOL8)
11. VOUT High (VOUTHIGH5 & VOUTHIGH6)
12. VOUT High (VOUTHIGH7 & VOUTHIGH8)
13. VOUT Low (VOUTLOW7 & VOUTLOW8)
14. VOUT Low (VOUTLOW9 & VOUTLOW10)
15. +SR (Slew Rate 5 and Slew Rate 6)
16. -SR (Slew Rate 7 and Slew Rate 8)

#### **+5V Tests**

17. Positive Supply Current (ICC2)
18. Negative Supply Current (IEE2)
19. Input Offset Voltage (VOS1 & VOS2)
20. Input Offset Current (IOS1 & IOS2)
21. + Input Bias Current (IB+1 & IB+2)
22. - Input Bias Current (IB-1 & IB-2)
23. Common Mode Rejection Ratio (CMRR1 & CMRR2)
24. Power Supply Rejection Ratio (PSRR1 & PSRR2)
25. Large Signal Voltage Gain (AVOL 1 & AVOL2)
26. Large Signal Voltage Gain (AVOL3 & AVOL4)
27. VOUT Low (VOUTLOW1 & VOUTLOW2)
28. VOUT Low (VOUTLOW3 & VOUTLOW4)
29. VOUT Low (VOUTLOW5 & VOUTLOW6)
30. VOUT High (VOUTHIGH1 & VOUTHIGH2)
31. VOUT High (VOUTHIGH3 & VOUTHIGH4)
32. +SR (Slew Rate 1 and Slew Rate 2)
33. -SR (Slew Rate 3 and Slew Rate 4)

Appendix C details the measured parameters, test conditions, pre-irradiation specification and measurement resolution for each of the measurements.

The parametric data was obtained as “read and record” and all the raw data plus an attributes summary are contained in this report as well as in a separate Excel file. The attributes data contains the average, standard deviation and the average with the KTL values applied. The KTL values used is 2.742 per MIL HDBK 814 using one sided tolerance limits of 90/90 and a 5-piece sample size. This survival probability/level of confidence is consistent with a 22-piece sample size and zero failures analyzed using a lot tolerance percent defective (LTPD) approach. Note that the following criteria must be met for a device to pass the total dose test: following the radiation exposure each of the 5 pieces irradiated under



electrical bias shall pass the specification value. The units irradiated without electrical bias and the KTL statistics are included in this report for reference only. If any of the 5 pieces irradiated under electrical bias exceed the datasheet specifications, then the lot could be logged as a failure.

Further, MIL-STD-883G, TM 1019.7 Section 3.13.1.1 Characterization test to determine if a part exhibits ELDRS” states the following: Select a minimum random sample of 21 devices from a population representative of recent production runs. Smaller sample sizes may be used if agreed upon between the parties to the test. All of the selected devices shall have undergone appropriate elevated temperature reliability screens, e.g. burn-in and high temperature storage life. Divide the samples into four groups of 5 each and use the remaining part for a control. Perform pre-irradiation electrical characterization on all parts assuring that they meet the Group A electrical tests. Irradiate 5 samples under a 0 volt bias and another 5 under the irradiation bias given in the acquisition specification at 50-300rad(Si)/s and room temperature. Irradiate 5 samples under a 0 volt bias and another 5 under irradiation bias given in the acquisition specification at < 10mrad(Si)/s and room temperature. Irradiate all samples to the same dose levels, including 0.5 and 1.0 times the anticipated specification dose, and repeat the electrical characterization on each part at each dose level. Post irradiation electrical measurements shall be performed per paragraph 3.10 where the low dose rate test is considered Condition D. Calculate the radiation induced change in each electrical parameter ( $\Delta_{para}$ ) for each sample at each radiation level. Calculate the ratio of the median  $\Delta_{para}$  at low dose rate to the median  $\Delta_{para}$  at high dose rate for each irradiation bias group at each total dose level. If this ratio exceeds 1.5 for any of the most sensitive parameters then the part is considered to be ELDRS susceptible. This test does not apply to parameters which exhibit changes that are within experimental error or whose values are below the pre-irradiation electrical specification limits at low dose rate at the specification dose.

Therefore, the data in this report can be analyzed along with the report titled “Enhanced Low Dose Rate Sensitivity (ELDRS) Radiation Testing of the RH1078MJ8 Dual Precision Op Amp for Linear Technology” to demonstrate that these parts do not exhibit ELDRS as defined in the current test method.

## **5.0. TID Test Results**

Using the conditions stated above, the RH1078MJ8 Dual Precision Op Amp (from the lot date code identified on the first page of this test report) passed the total dose test to the maximum tested level of 50krad(Si) with no significant degradation observed on any measured parameter. Note that the data presented in this report for the units-under-test irradiated in the unbiased condition and the KTL statistics are for reference only and are not used for the determination of “PASS/FAIL” for the lot.

Figures 5.1 through 5.62 show plots of all the measured parameters versus total ionizing dose while Tables 5.1 – 5.62 show the corresponding raw data for each of these parameters. In these data plots the solid diamonds are the average of the measured data points for the sample irradiated under electrical bias while the shaded diamonds are the average of the measured data points for the units irradiated with all pins tied to ground. The black lines (solid or dashed) are the average of the data points after application



**TID Report  
10-004 100412 R1.0**

**Radiation Assured Devices  
5017 N. 30th Street  
Colorado Springs, CO 80919  
(719) 531-0800**

of the KTL statistics on the sample irradiated in the biased condition while the shaded lines (solid or dashed) are the average of the data points after application of the KTL statistics on the sample irradiated in the unbiased condition. The red dotted line(s) are the pre- and/or post-irradiation minimum and/or maximum specification value as defined in the datasheet and/or test plan.

In addition to the radiation test results, the data plots and tables described above contain anneal data. The anneals are performed to better understand the underlying physical mechanisms responsible for radiation-induced parametric shifts and are not part of the criteria used to establish whether or not the lot passes or fails the total dose test. In all cases the parts either improved or exhibited no change during the anneal.

As seen clearly in these figures, the pre- and post-irradiation data are well within the specification even after application of the KTL statistics and the control units, as expected, show no significant changes to any of the parameters throughout the course of the measurements. Therefore we can conclude that any observed degradation was due to the radiation exposure and not drift in the test equipment.

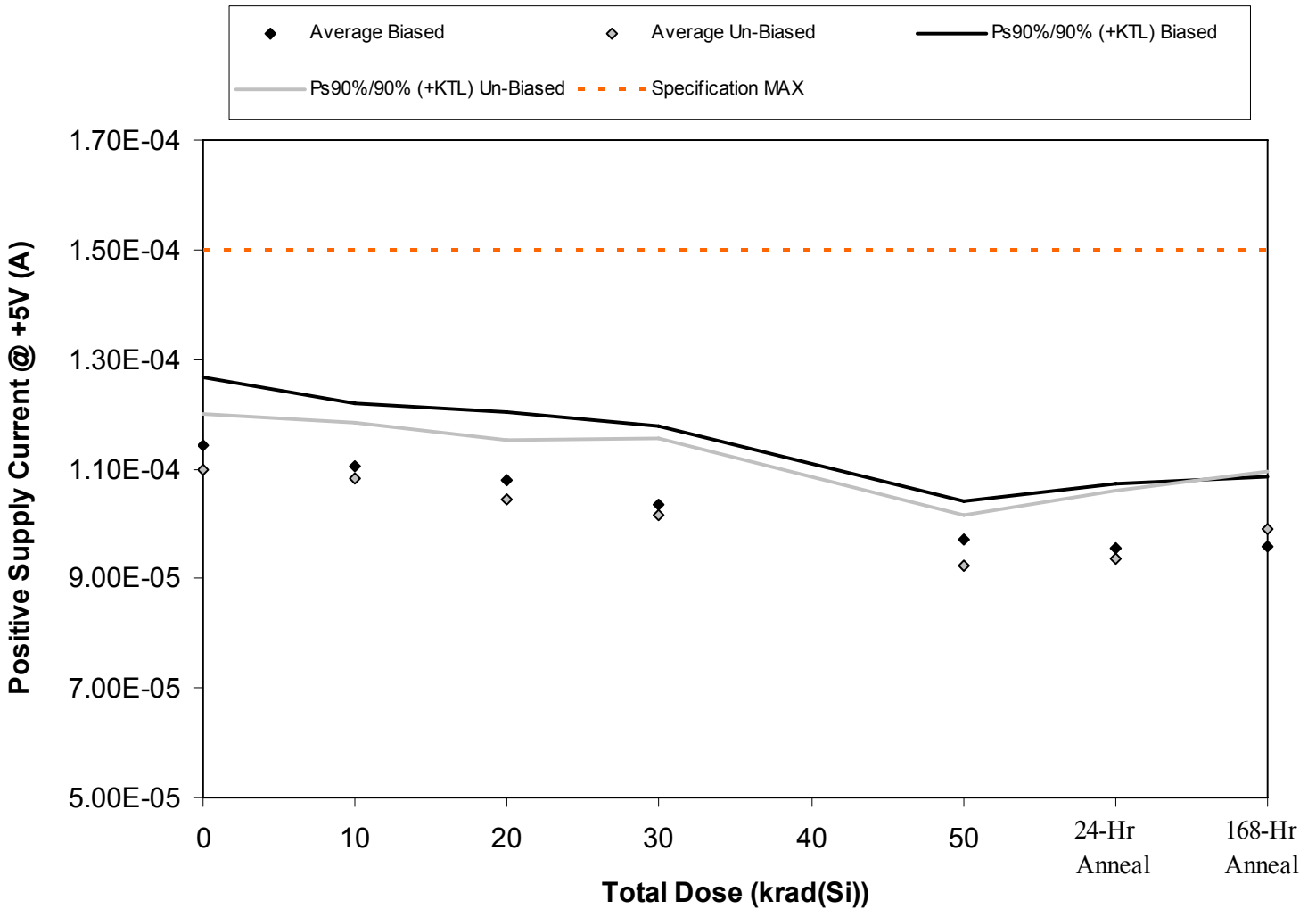

Figure 5.1. Plot of Positive Supply Current @ +5V (A) versus total dose. The solid diamonds are the average of the measured data points for the samples irradiated under electrical bias while the shaded diamonds are the average of the measured data points for the samples irradiated with all pins tied to ground. The black lines (solid and/or dashed) are the average of the data points after application of the KTL statistics on the samples irradiated under electrical bias while the gray lines (solid and/or dashed) are the average of the data points after application of the KTL statistics on the samples irradiated in the unbiased condition. The red dotted line(s) are the pre- and/or post-irradiation minimum and/or maximum specification value as defined in the datasheet and/or test plan.





Table 5.1. Raw data for Positive Supply Current @ +5V (A) versus total dose, including the statistical analysis, specification and the status of the testing (pass/fail).

Positive Supply Current @ +5V (A)	Total Dose (krad(Si))					24 hr Anneal	168 hr Anneal
	0	10	20	30	50		
Device	0	10	20	30	50		
255	1.12E-04	1.05E-04	1.03E-04	9.70E-05	9.30E-05	9.10E-05	9.00E-05
258	1.21E-04	1.15E-04	1.14E-04	1.10E-04	9.90E-05	1.01E-04	1.01E-04
309	1.16E-04	1.13E-04	1.09E-04	1.06E-04	9.90E-05	9.90E-05	9.80E-05
359	1.13E-04	1.12E-04	1.10E-04	1.05E-04	9.80E-05	9.40E-05	9.80E-05
360	1.09E-04	1.07E-04	1.04E-04	1.00E-04	9.60E-05	9.30E-05	9.20E-05
416	1.04E-04	1.03E-04	9.90E-05	9.50E-05	8.80E-05	8.80E-05	9.40E-05
472	1.11E-04	1.10E-04	1.05E-04	1.03E-04	9.50E-05	9.50E-05	9.90E-05
473	1.11E-04	1.08E-04	1.03E-04	1.00E-04	9.30E-05	9.10E-05	1.01E-04
526	1.14E-04	1.13E-04	1.10E-04	1.09E-04	9.60E-05	1.00E-04	1.04E-04
529	1.09E-04	1.08E-04	1.05E-04	1.01E-04	9.00E-05	9.40E-05	9.70E-05
530	1.11E-04	1.13E-04	1.13E-04	1.13E-04	1.12E-04	1.12E-04	1.14E-04
561	1.10E-04	1.11E-04	1.13E-04	1.10E-04	1.09E-04	1.10E-04	1.12E-04
<b>Biased Statistics</b>							
Average Biased	1.14E-04	1.10E-04	1.08E-04	1.04E-04	9.70E-05	9.56E-05	9.58E-05
Std Dev Biased	4.55E-06	4.22E-06	4.53E-06	5.13E-06	2.55E-06	4.22E-06	4.60E-06
Ps90%/90% (+KTL) Biased	1.27E-04	1.22E-04	1.20E-04	1.18E-04	1.04E-04	1.07E-04	1.08E-04
Ps90%/90% (-KTL) Biased	1.02E-04	9.88E-05	9.56E-05	8.95E-05	9.00E-05	8.40E-05	8.32E-05
<b>Un-Biased Statistics</b>							
Average Un-Biased	1.10E-04	1.08E-04	1.04E-04	1.02E-04	9.24E-05	9.36E-05	9.90E-05
Std Dev Un-Biased	3.70E-06	3.65E-06	3.97E-06	5.08E-06	3.36E-06	4.51E-06	3.81E-06
Ps90%/90% (+KTL) Un-Biased	1.20E-04	1.18E-04	1.15E-04	1.16E-04	1.02E-04	1.06E-04	1.09E-04
Ps90%/90% (-KTL) Un-Biased	9.97E-05	9.84E-05	9.35E-05	8.77E-05	8.32E-05	8.12E-05	8.86E-05
<b>Specification MAX</b>	<b>1.50E-04</b>	<b>1.50E-04</b>	<b>1.50E-04</b>	<b>1.50E-04</b>	<b>1.50E-04</b>	<b>1.50E-04</b>	<b>1.50E-04</b>
Status	PASS	PASS	PASS	PASS	PASS	PASS	PASS

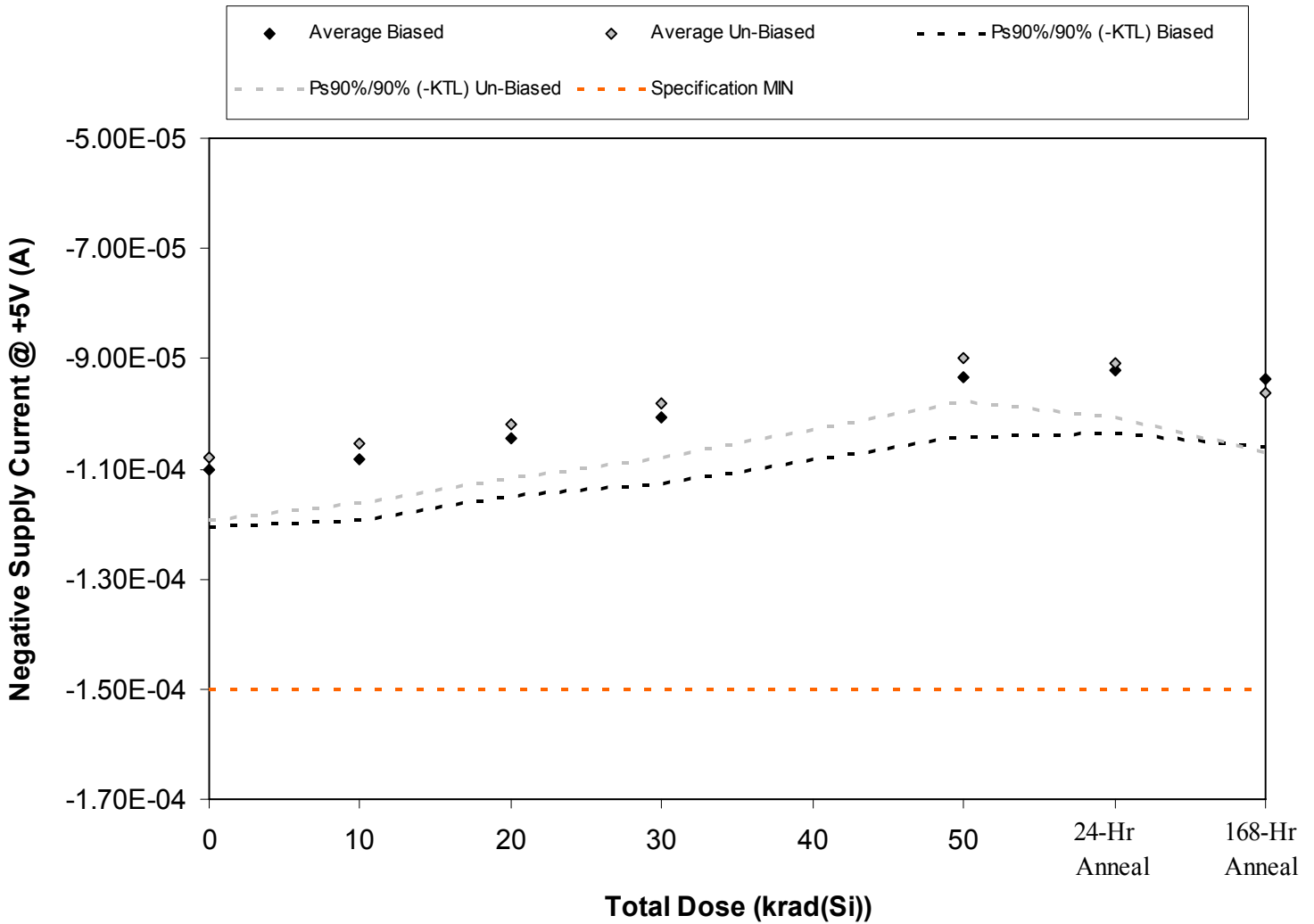

Figure 5.2. Plot of Negative Supply Current @ +5V (A) versus total dose. The solid diamonds are the average of the measured data points for the samples irradiated under electrical bias while the shaded diamonds are the average of the measured data points for the samples irradiated with all pins tied to ground. The black lines (solid and/or dashed) are the average of the data points after application of the KTL statistics on the samples irradiated under electrical bias while the gray lines (solid and/or dashed) are the average of the data points after application of the KTL statistics on the samples irradiated in the unbiased condition. The red dotted line(s) are the pre- and/or post-irradiation minimum and/or maximum specification value as defined in the datasheet and/or test plan.



Table 5.2. Raw data for Negative Supply Current @ +5V (A) versus total dose, including the statistical analysis, specification and the status of the testing (pass/fail).

Negative Supply Current @ +5V (A)	Total Dose (krad(Si))					24 hr Anneal	168 hr Anneal
	0	10	20	30	50		
Device							
255	-1.06E-04	-1.04E-04	-1.00E-04	-9.50E-05	-8.80E-05	-8.70E-05	-8.80E-05
258	-1.15E-04	-1.13E-04	-1.09E-04	-1.05E-04	-9.80E-05	-9.80E-05	-9.90E-05
309	-1.13E-04	-1.11E-04	-1.07E-04	-1.04E-04	-9.60E-05	-9.40E-05	-9.60E-05
359	-1.10E-04	-1.09E-04	-1.05E-04	-1.02E-04	-9.40E-05	-9.20E-05	-9.50E-05
360	-1.07E-04	-1.04E-04	-1.01E-04	-9.70E-05	-9.10E-05	-9.00E-05	-9.00E-05
416	-1.02E-04	-1.00E-04	-9.70E-05	-9.30E-05	-8.60E-05	-8.60E-05	-9.10E-05
472	-1.08E-04	-1.06E-04	-1.02E-04	-9.90E-05	-9.10E-05	-9.20E-05	-9.70E-05
473	-1.07E-04	-1.05E-04	-1.02E-04	-9.80E-05	-8.90E-05	-9.00E-05	-9.60E-05
526	-1.14E-04	-1.11E-04	-1.07E-04	-1.03E-04	-9.40E-05	-9.60E-05	-1.02E-04
529	-1.08E-04	-1.05E-04	-1.02E-04	-9.80E-05	-8.90E-05	-9.00E-05	-9.50E-05
530	-1.11E-04	-1.11E-04	-1.11E-04	-1.11E-04	-1.10E-04	-1.10E-04	-1.11E-04
561	-1.09E-04	-1.09E-04	-1.09E-04	-1.09E-04	-1.08E-04	-1.10E-04	-1.08E-04
<b>Biased Statistics</b>							
Average Biased	-1.10E-04	-1.08E-04	-1.04E-04	-1.01E-04	-9.34E-05	-9.22E-05	-9.36E-05
Std Dev Biased	3.83E-06	4.09E-06	3.85E-06	4.39E-06	3.97E-06	4.15E-06	4.51E-06
Ps90%/90% (+KTL) Biased	-9.97E-05	-9.70E-05	-9.39E-05	-8.86E-05	-8.25E-05	-8.08E-05	-8.12E-05
Ps90%/90% (-KTL) Biased	-1.21E-04	-1.19E-04	-1.15E-04	-1.13E-04	-1.04E-04	-1.04E-04	-1.06E-04
<b>Un-Biased Statistics</b>							
Average Un-Biased	-1.08E-04	-1.05E-04	-1.02E-04	-9.82E-05	-8.98E-05	-9.08E-05	-9.62E-05
Std Dev Un-Biased	4.27E-06	3.91E-06	3.54E-06	3.56E-06	2.95E-06	3.63E-06	3.96E-06
Ps90%/90% (+KTL) Un-Biased	-9.61E-05	-9.47E-05	-9.23E-05	-8.84E-05	-8.17E-05	-8.08E-05	-8.53E-05
Ps90%/90% (-KTL) Un-Biased	-1.19E-04	-1.16E-04	-1.12E-04	-1.08E-04	-9.79E-05	-1.01E-04	-1.07E-04
<b>Specification MIN</b>	<b>-1.50E-04</b>	<b>-1.50E-04</b>	<b>-1.50E-04</b>	<b>-1.50E-04</b>	<b>-1.50E-04</b>	<b>-1.50E-04</b>	<b>-1.50E-04</b>
Status	PASS	PASS	PASS	PASS	PASS	PASS	PASS

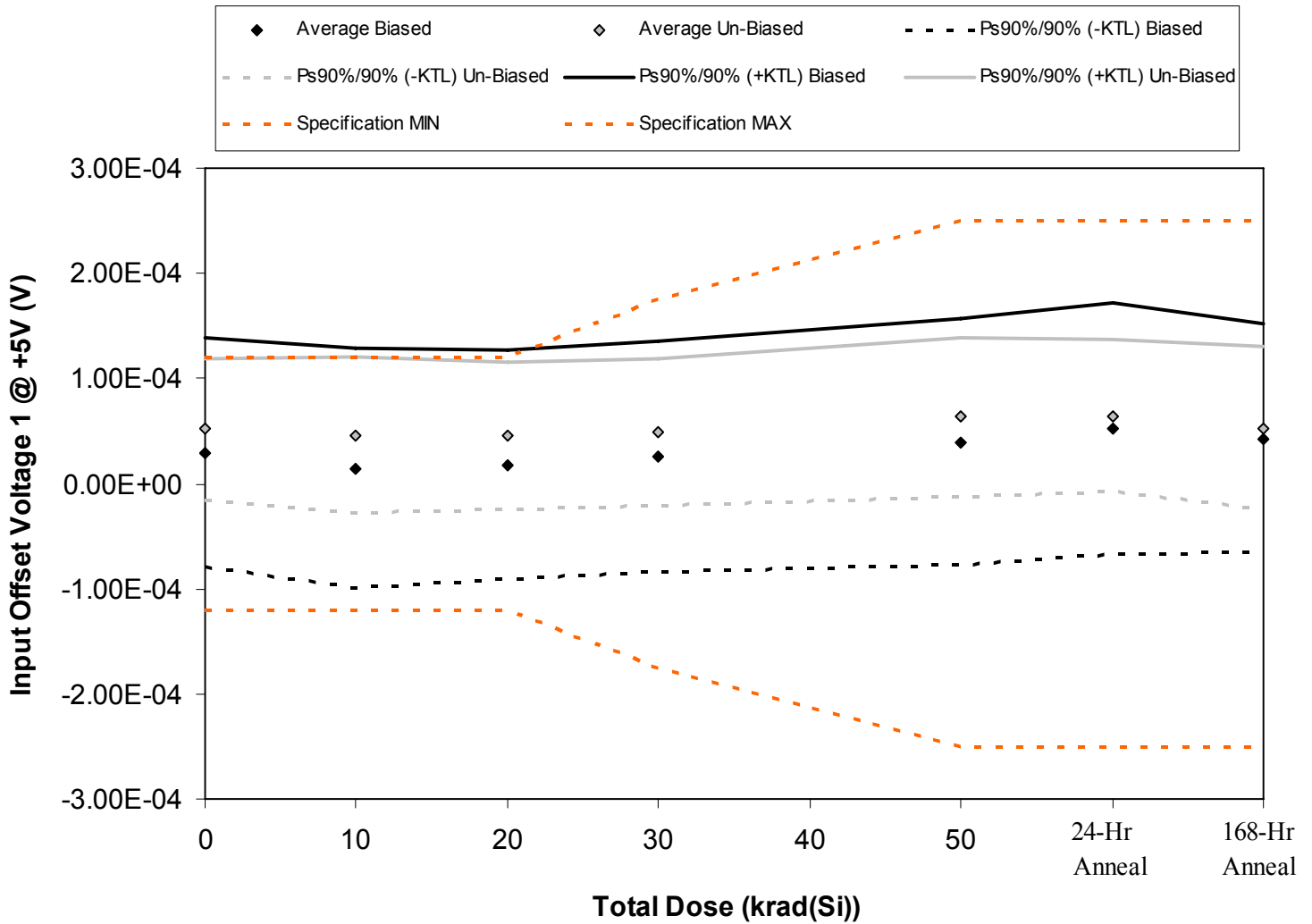

Figure 5.3. Plot of Input Offset Voltage 1 @ +5V (V) versus total dose. The solid diamonds are the average of the measured data points for the samples irradiated under electrical bias while the shaded diamonds are the average of the measured data points for the samples irradiated with all pins tied to ground. The black lines (solid and/or dashed) are the average of the data points after application of the KTL statistics on the samples irradiated under electrical bias while the gray lines (solid and/or dashed) are the average of the data points after application of the KTL statistics on the samples irradiated in the unbiased condition. The red dotted line(s) are the pre- and/or post-irradiation minimum and/or maximum specification value as defined in the datasheet and/or test plan.



Table 5.3. Raw data for Input Offset Voltage 1 @ +5V (V) versus total dose, including the statistical analysis, specification and the status of the testing (pass/fail).

Input Offset Voltage 1 @ +5V (V)	Total Dose (krad(Si))					24 hr Anneal	168 hr Anneal
	0	10	20	30	50		
Device							
255	4.09E-05	2.44E-05	3.02E-05	3.98E-05	6.67E-05	7.99E-05	6.82E-05
258	5.41E-05	3.92E-05	3.51E-05	4.68E-05	5.90E-05	7.33E-05	5.22E-05
309	6.44E-05	5.18E-05	5.62E-05	5.89E-05	6.88E-05	8.13E-05	7.17E-05
359	-3.62E-05	-5.42E-05	-4.86E-05	-4.29E-05	-3.33E-05	-2.24E-05	-2.55E-05
360	2.32E-05	1.33E-05	1.83E-05	2.44E-05	3.74E-05	5.25E-05	4.77E-05
416	3.96E-05	3.45E-05	4.01E-05	4.45E-05	4.90E-05	5.00E-05	4.05E-05
472	1.88E-05	1.20E-05	1.19E-05	1.48E-05	2.62E-05	2.88E-05	1.66E-05
473	7.22E-05	6.63E-05	6.34E-05	6.65E-05	8.30E-05	8.25E-05	6.42E-05
526	7.93E-05	8.04E-05	7.69E-05	8.04E-05	9.68E-05	9.62E-05	9.28E-05
529	4.86E-05	3.86E-05	3.38E-05	4.02E-05	6.13E-05	6.47E-05	4.98E-05
530	1.30E-05	1.50E-05	1.69E-05	1.12E-05	1.17E-05	1.69E-05	1.06E-05
561	2.61E-05	2.91E-05	2.76E-05	3.03E-05	3.09E-05	2.92E-05	3.04E-05
<b>Biased Statistics</b>							
Average Biased	2.93E-05	1.49E-05	1.82E-05	2.54E-05	3.97E-05	5.29E-05	4.28E-05
Std Dev Biased	3.97E-05	4.13E-05	3.98E-05	4.02E-05	4.27E-05	4.36E-05	3.95E-05
Ps90%/90% (+KTL) Biased	1.38E-04	1.28E-04	1.27E-04	1.36E-04	1.57E-04	1.73E-04	1.51E-04
Ps90%/90% (-KTL) Biased	-7.97E-05	-9.83E-05	-9.10E-05	-8.47E-05	-7.73E-05	-6.67E-05	-6.56E-05
<b>Un-Biased Statistics</b>							
Average Un-Biased	5.17E-05	4.64E-05	4.52E-05	4.93E-05	6.33E-05	6.44E-05	5.28E-05
Std Dev Un-Biased	2.46E-05	2.71E-05	2.55E-05	2.53E-05	2.78E-05	2.65E-05	2.83E-05
Ps90%/90% (+KTL) Un-Biased	1.19E-04	1.21E-04	1.15E-04	1.19E-04	1.40E-04	1.37E-04	1.30E-04
Ps90%/90% (-KTL) Un-Biased	-1.57E-05	-2.80E-05	-2.46E-05	-2.00E-05	-1.30E-05	-8.28E-06	-2.47E-05
Specification MIN	-1.20E-04	-1.20E-04	-1.20E-04	-1.75E-04	-2.50E-04	-2.50E-04	-2.50E-04
Status	PASS	PASS	PASS	PASS	PASS	PASS	PASS
Specification MAX	1.20E-04	1.20E-04	1.20E-04	1.75E-04	2.50E-04	2.50E-04	2.50E-04
Status	PASS	PASS	PASS	PASS	PASS	PASS	PASS

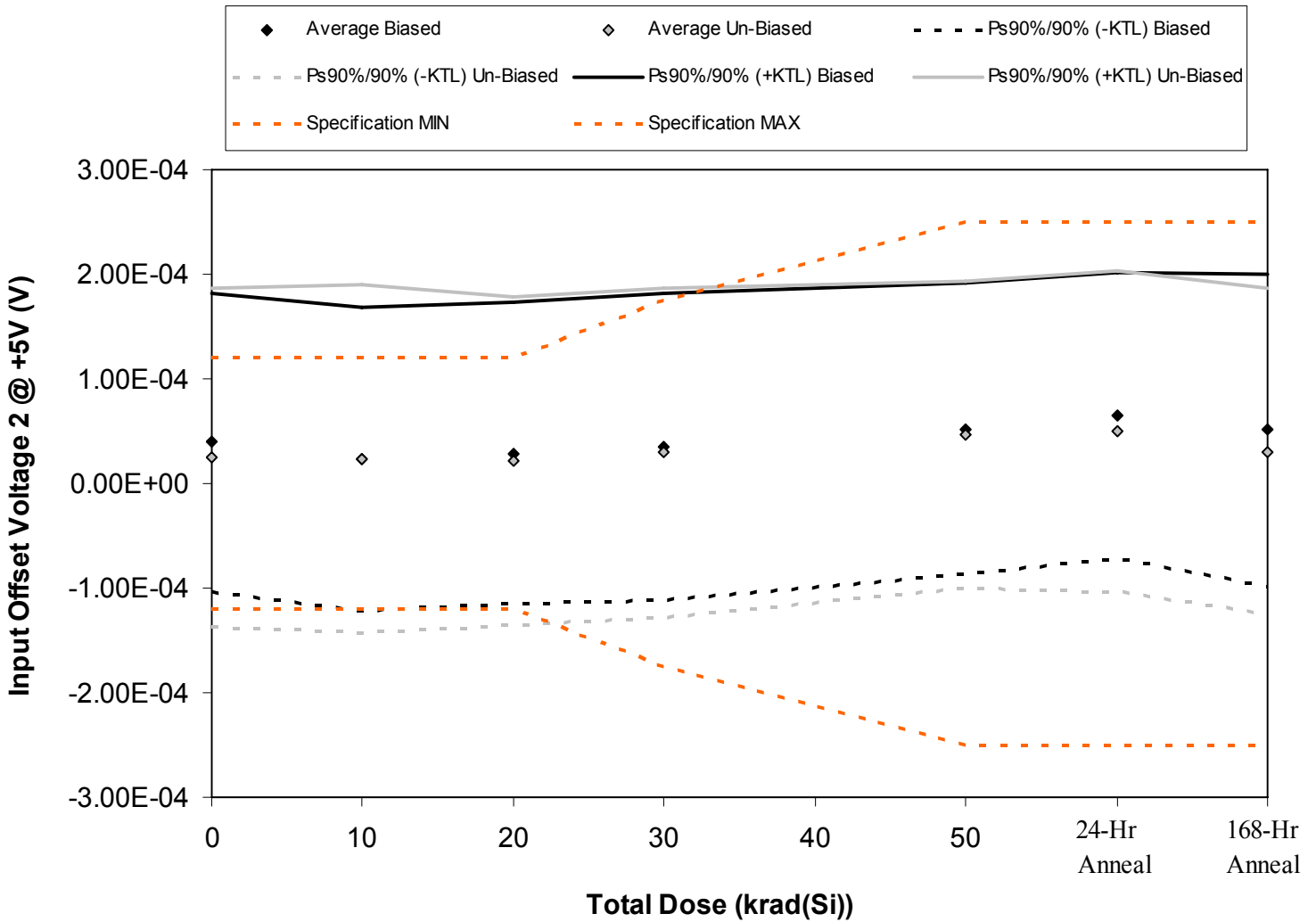

Figure 5.4. Plot of Input Offset Voltage 2 @ +5V (V) versus total dose. The solid diamonds are the average of the measured data points for the samples irradiated under electrical bias while the shaded diamonds are the average of the measured data points for the samples irradiated with all pins tied to ground. The black lines (solid and/or dashed) are the average of the data points after application of the KTL statistics on the samples irradiated under electrical bias while the gray lines (solid and/or dashed) are the average of the data points after application of the KTL statistics on the samples irradiated in the unbiased condition. The red dotted line(s) are the pre- and/or post-irradiation minimum and/or maximum specification value as defined in the datasheet and/or test plan.



**TID Report**  
**10-004 100412 R1.0**

**Radiation Assured Devices**  
**5017 N. 30th Street**  
**Colorado Springs, CO 80919**  
**(719) 531-0800**

Table 5.4. Raw data for Input Offset Voltage 2 @ +5V (V) versus total dose, including the statistical analysis, specification and the status of the testing (pass/fail).

Input Offset Voltage 2 @ +5V (V)	Total Dose (krad(Si))					24 hr Anneal	168 hr Anneal
	0	10	20	30	50		
Device							
255	-3.95E-05	-5.89E-05	-5.11E-05	-4.72E-05	-2.56E-05	-1.23E-05	-3.13E-05
258	9.29E-05	7.74E-05	8.01E-05	8.61E-05	9.95E-05	1.12E-04	9.75E-05
309	1.81E-05	3.02E-06	4.81E-06	1.16E-05	3.11E-05	4.44E-05	3.06E-05
359	5.82E-05	4.08E-05	4.76E-05	5.36E-05	6.67E-05	8.11E-05	6.01E-05
360	6.92E-05	5.15E-05	6.31E-05	6.98E-05	9.00E-05	9.92E-05	9.96E-05
416	-8.83E-06	-1.13E-05	-1.04E-05	-3.52E-06	1.44E-05	1.89E-05	-5.22E-06
472	8.73E-05	8.92E-05	7.81E-05	8.74E-05	9.83E-05	1.03E-04	8.66E-05
473	4.96E-05	4.54E-05	4.21E-05	5.03E-05	6.43E-05	7.16E-05	4.48E-05
526	5.70E-05	5.83E-05	6.03E-05	6.67E-05	8.57E-05	8.79E-05	7.57E-05
529	-5.96E-05	-6.35E-05	-6.10E-05	-5.40E-05	-3.04E-05	-3.18E-05	-4.82E-05
530	-4.47E-05	-4.02E-05	-4.26E-05	-4.20E-05	-4.24E-05	-4.00E-05	-4.36E-05
561	6.77E-05	7.04E-05	6.82E-05	6.82E-05	6.99E-05	7.16E-05	6.96E-05
<b>Biased Statistics</b>							
Average Biased	3.98E-05	2.28E-05	2.89E-05	3.47E-05	5.24E-05	6.48E-05	5.13E-05
Std Dev Biased	5.19E-05	5.29E-05	5.27E-05	5.35E-05	5.09E-05	5.00E-05	5.43E-05
Ps90%/90% (+KTL) Biased	1.82E-04	1.68E-04	1.73E-04	1.82E-04	1.92E-04	2.02E-04	2.00E-04
Ps90%/90% (-KTL) Biased	-1.03E-04	-1.22E-04	-1.16E-04	-1.12E-04	-8.73E-05	-7.23E-05	-9.76E-05
<b>Un-Biased Statistics</b>							
Average Un-Biased	2.51E-05	2.36E-05	2.18E-05	2.94E-05	4.64E-05	5.00E-05	3.07E-05
Std Dev Un-Biased	5.88E-05	6.08E-05	5.69E-05	5.75E-05	5.36E-05	5.57E-05	5.67E-05
Ps90%/90% (+KTL) Un-Biased	1.86E-04	1.90E-04	1.78E-04	1.87E-04	1.93E-04	2.03E-04	1.86E-04
Ps90%/90% (-KTL) Un-Biased	-1.36E-04	-1.43E-04	-1.34E-04	-1.28E-04	-1.01E-04	-1.03E-04	-1.25E-04
<b>Specification MIN</b>	<b>-1.20E-04</b>	<b>-1.20E-04</b>	<b>-1.20E-04</b>	<b>-1.75E-04</b>	<b>-2.50E-04</b>	<b>-2.50E-04</b>	<b>-2.50E-04</b>
Status	PASS	PASS	PASS	PASS	PASS	PASS	PASS
<b>Specification MAX</b>	<b>1.20E-04</b>	<b>1.20E-04</b>	<b>1.20E-04</b>	<b>1.75E-04</b>	<b>2.50E-04</b>	<b>2.50E-04</b>	<b>2.50E-04</b>
Status	PASS	PASS	PASS	PASS	PASS	PASS	PASS

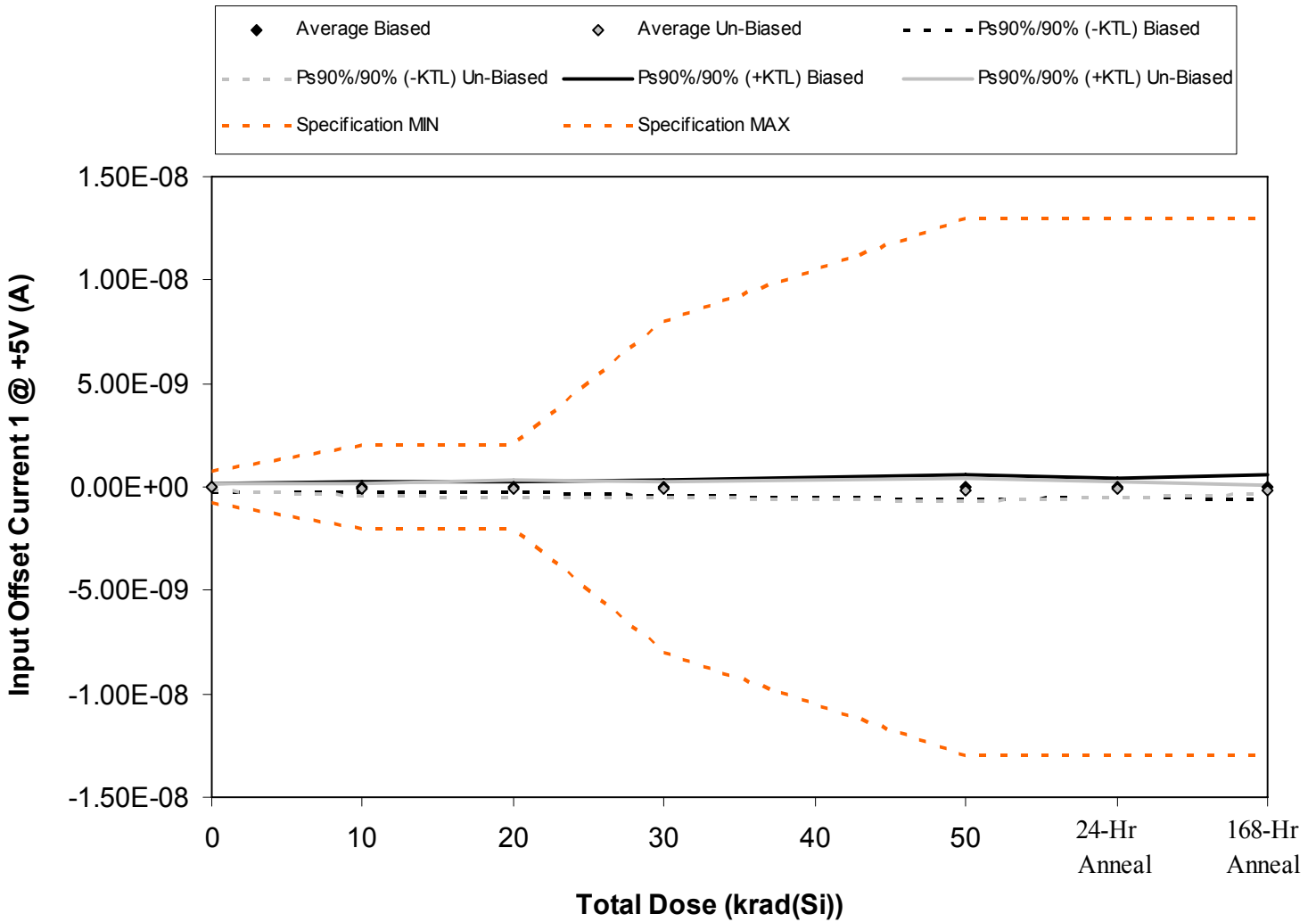

Figure 5.5. Plot of Input Offset Current 1 @ +5V (A) versus total dose. The solid diamonds are the average of the measured data points for the samples irradiated under electrical bias while the shaded diamonds are the average of the measured data points for the samples irradiated with all pins tied to ground. The black lines (solid and/or dashed) are the average of the data points after application of the KTL statistics on the samples irradiated under electrical bias while the gray lines (solid and/or dashed) are the average of the data points after application of the KTL statistics on the samples irradiated in the unbiased condition. The red dotted line(s) are the pre- and/or post-irradiation minimum and/or maximum specification value as defined in the datasheet and/or test plan.





**TID Report  
10-004 100412 R1.0**

**Radiation Assured Devices  
5017 N. 30th Street  
Colorado Springs, CO 80919  
(719) 531-0800**

Table 5.5. Raw data for Input Offset Current 1 @ +5V (A) versus total dose, including the statistical analysis, specification and the status of the testing (pass/fail).

Input Offset Current 1 @ +5V (A)	Total Dose (krad(Si))					24 hr Anneal	168 hr Anneal
	0	10	20	30	50		
Device	0	10	20	30	50		
255	8.00E-11	1.00E-11	2.00E-11	-1.70E-10	7.00E-11	-4.00E-11	-1.30E-10
258	-1.20E-10	2.00E-11	-8.00E-11	6.00E-11	1.10E-10	1.10E-10	2.60E-10
309	-6.00E-11	-9.00E-11	-6.00E-11	-1.90E-10	-3.80E-10	-2.80E-10	-2.60E-10
359	0.00E+00	-2.00E-11	-2.00E-11	4.00E-11	4.00E-11	-3.00E-11	2.00E-10
360	-7.00E-11	1.60E-10	1.20E-10	1.10E-10	2.00E-10	1.20E-10	-5.00E-11
416	9.00E-11	-1.00E-10	-4.00E-11	-3.00E-11	0.00E+00	3.00E-11	-5.00E-11
472	-6.00E-11	3.00E-11	1.30E-10	5.00E-11	6.00E-11	5.00E-11	-1.80E-10
473	-7.00E-11	-4.00E-11	-1.30E-10	-1.50E-10	-4.10E-10	-2.60E-10	-5.00E-11
526	-4.00E-11	-2.40E-10	-8.00E-11	-1.20E-10	-8.00E-11	-2.00E-10	-1.50E-10
529	-3.00E-11	-2.00E-10	-3.10E-10	-3.00E-10	-2.40E-10	-1.10E-10	-2.50E-10
530	-8.00E-11	-1.10E-10	-1.10E-10	-1.80E-10	-1.60E-10	-2.10E-10	-1.40E-10
561	-4.00E-11	-1.20E-10	3.00E-11	0.00E+00	-6.00E-11	0.00E+00	-6.00E-11
<b>Biased Statistics</b>							
Average Biased	-3.40E-11	1.60E-11	-4.00E-12	-3.00E-11	8.00E-12	-2.40E-11	4.00E-12
Std Dev Biased	7.67E-11	9.13E-11	7.92E-11	1.39E-10	2.25E-10	1.62E-10	2.21E-10
Ps90%/90% (+KTL) Biased	1.76E-10	2.66E-10	2.13E-10	3.52E-10	6.25E-10	4.19E-10	6.09E-10
Ps90%/90% (-KTL) Biased	-2.44E-10	-2.34E-10	-2.21E-10	-4.12E-10	-6.09E-10	-4.67E-10	-6.01E-10
<b>Un-Biased Statistics</b>							
Average Un-Biased	-2.20E-11	-1.10E-10	-8.60E-11	-1.10E-10	-1.34E-10	-9.80E-11	-1.36E-10
Std Dev Un-Biased	6.46E-11	1.11E-10	1.59E-10	1.32E-10	1.91E-10	1.37E-10	8.65E-11
Ps90%/90% (+KTL) Un-Biased	1.55E-10	1.95E-10	3.50E-10	2.52E-10	3.90E-10	2.78E-10	1.01E-10
Ps90%/90% (-KTL) Un-Biased	-1.99E-10	-4.15E-10	-5.22E-10	-4.72E-10	-6.58E-10	-4.74E-10	-3.73E-10
<b>Specification MIN</b>	<b>-8.00E-10</b>	<b>-2.00E-09</b>	<b>-2.00E-09</b>	<b>-8.00E-09</b>	<b>-1.30E-08</b>	<b>-1.30E-08</b>	<b>-1.30E-08</b>
Status	PASS	PASS	PASS	PASS	PASS	PASS	PASS
<b>Specification MAX</b>	<b>8.00E-10</b>	<b>2.00E-09</b>	<b>2.00E-09</b>	<b>8.00E-09</b>	<b>1.30E-08</b>	<b>1.30E-08</b>	<b>1.30E-08</b>
Status	PASS	PASS	PASS	PASS	PASS	PASS	PASS

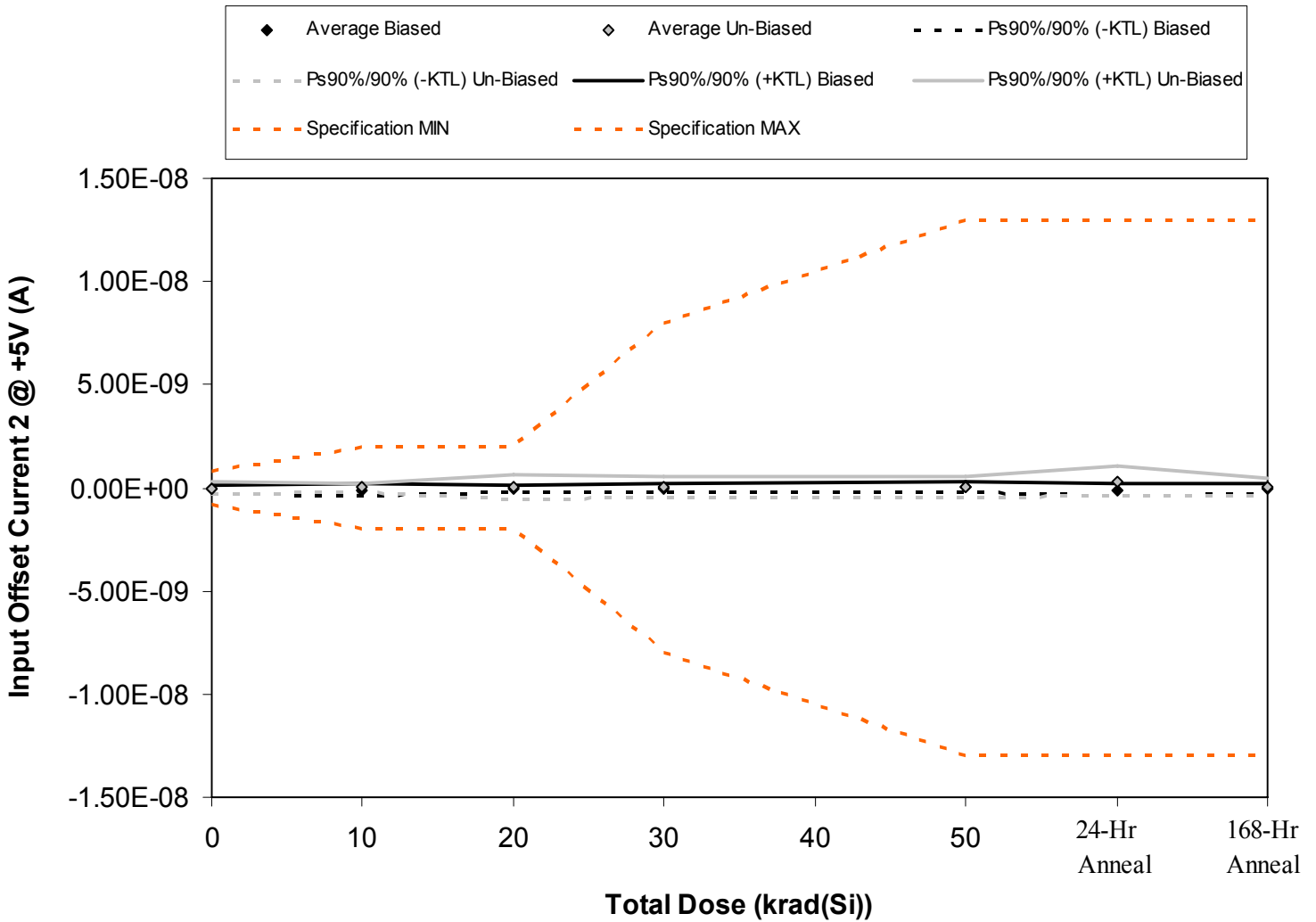

Figure 5.6. Plot of Input Offset Current 2 @ +5V (A) versus total dose. The solid diamonds are the average of the measured data points for the samples irradiated under electrical bias while the shaded diamonds are the average of the measured data points for the samples irradiated with all pins tied to ground. The black lines (solid and/or dashed) are the average of the data points after application of the KTL statistics on the samples irradiated under electrical bias while the gray lines (solid and/or dashed) are the average of the data points after application of the KTL statistics on the samples irradiated in the unbiased condition. The red dotted line(s) are the pre- and/or post-irradiation minimum and/or maximum specification value as defined in the datasheet and/or test plan.



**TID Report  
10-004 100412 R1.0**

**Radiation Assured Devices  
5017 N. 30th Street  
Colorado Springs, CO 80919  
(719) 531-0800**

Table 5.6. Raw data for Input Offset Current 2 @ +5V (A) versus total dose, including the statistical analysis, specification and the status of the testing (pass/fail).

Input Offset Current 2 @ +5V (A)	Total Dose (krad(Si))					24 hr Anneal	168 hr Anneal
	0	10	20	30	50		
Device							
255	5.00E-11	1.00E-11	4.00E-11	1.00E-10	0.00E+00	1.00E-11	3.00E-11
258	-1.20E-10	-5.00E-11	-7.00E-11	-3.00E-11	1.00E-10	-2.30E-10	-1.70E-10
309	-9.00E-11	-2.10E-10	-1.10E-10	-6.00E-11	-1.00E-11	-2.00E-10	0.00E+00
359	-1.40E-10	-1.60E-10	-1.30E-10	-2.00E-11	-1.40E-10	-3.00E-11	0.00E+00
360	0.00E+00	-2.00E-11	-7.00E-11	-9.00E-11	7.00E-11	-4.00E-11	6.00E-11
416	-1.00E-11	1.30E-10	1.60E-10	2.00E-11	6.00E-11	1.90E-10	0.00E+00
472	-1.40E-10	0.00E+00	-1.50E-10	-9.00E-11	-3.00E-11	1.90E-10	2.00E-11
473	-4.00E-11	-8.00E-11	8.00E-11	1.10E-10	-2.00E-11	3.50E-10	2.00E-11
526	-2.00E-11	-4.00E-11	-2.50E-10	-2.10E-10	-1.80E-10	1.20E-10	-1.40E-10
529	1.40E-10	2.00E-11	2.80E-10	2.90E-10	3.50E-10	7.60E-10	3.00E-10
530	-5.00E-11	-4.00E-11	-4.00E-11	-6.00E-11	-2.00E-11	0.00E+00	0.00E+00
561	-2.20E-10	-1.50E-10	-2.70E-10	-2.00E-10	-1.40E-10	-1.60E-10	-1.20E-10
<b>Biased Statistics</b>							
Average Biased	-6.00E-11	-8.60E-11	-6.80E-11	-2.00E-11	4.00E-12	-9.80E-11	-1.60E-11
Std Dev Biased	8.15E-11	9.45E-11	6.57E-11	7.25E-11	9.29E-11	1.09E-10	8.96E-11
Ps90%/90% (+KTL) Biased	1.64E-10	1.73E-10	1.12E-10	1.79E-10	2.59E-10	2.01E-10	2.30E-10
Ps90%/90% (-KTL) Biased	-2.84E-10	-3.45E-10	-2.48E-10	-2.19E-10	-2.51E-10	-3.97E-10	-2.62E-10
<b>Un-Biased Statistics</b>							
Average Un-Biased	-1.40E-11	6.00E-12	2.40E-11	2.40E-11	3.60E-11	3.22E-10	4.00E-11
Std Dev Un-Biased	1.00E-10	7.92E-11	2.19E-10	1.91E-10	1.96E-10	2.59E-10	1.60E-10
Ps90%/90% (+KTL) Un-Biased	2.61E-10	2.23E-10	6.26E-10	5.48E-10	5.73E-10	1.03E-09	4.79E-10
Ps90%/90% (-KTL) Un-Biased	-2.89E-10	-2.11E-10	-5.78E-10	-5.00E-10	-5.01E-10	-3.88E-10	-3.99E-10
<b>Specification MIN</b>	<b>-8.00E-10</b>	<b>-2.00E-09</b>	<b>-2.00E-09</b>	<b>-8.00E-09</b>	<b>-1.30E-08</b>	<b>-1.30E-08</b>	<b>-1.30E-08</b>
Status	PASS	PASS	PASS	PASS	PASS	PASS	PASS
<b>Specification MAX</b>	<b>8.00E-10</b>	<b>2.00E-09</b>	<b>2.00E-09</b>	<b>8.00E-09</b>	<b>1.30E-08</b>	<b>1.30E-08</b>	<b>1.30E-08</b>
Status	PASS	PASS	PASS	PASS	PASS	PASS	PASS

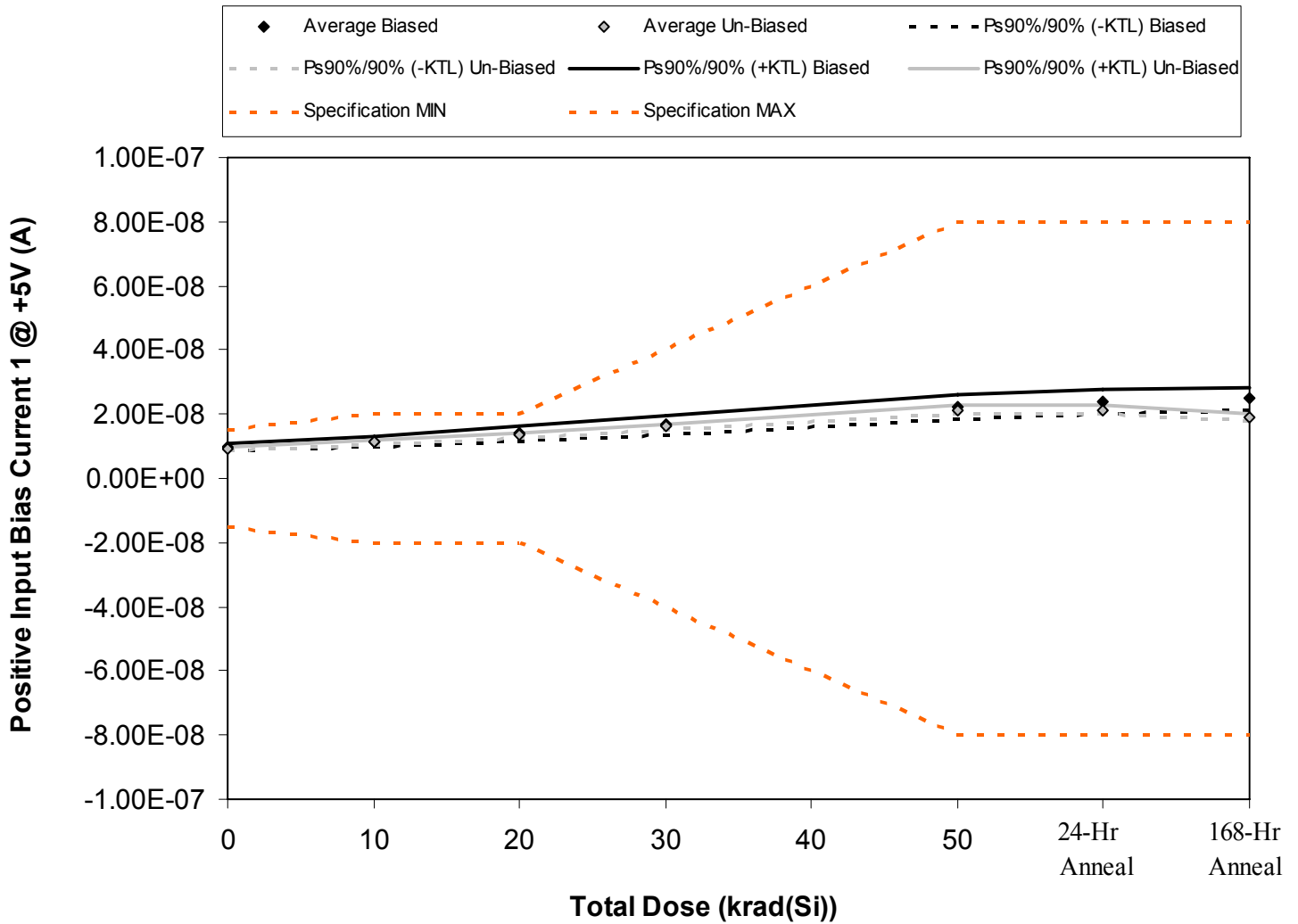

Figure 5.7. Plot of Positive Input Bias Current 1 @ +5V (A) versus total dose. The solid diamonds are the average of the measured data points for the samples irradiated under electrical bias while the shaded diamonds are the average of the measured data points for the samples irradiated with all pins tied to ground. The black lines (solid and/or dashed) are the average of the data points after application of the KTL statistics on the samples irradiated under electrical bias while the gray lines (solid and/or dashed) are the average of the data points after application of the KTL statistics on the samples irradiated in the unbiased condition. The red dotted line(s) are the pre- and/or post-irradiation minimum and/or maximum specification value as defined in the datasheet and/or test plan.



**TID Report  
10-004 100412 R1.0**

**Radiation Assured Devices  
5017 N. 30th Street  
Colorado Springs, CO 80919  
(719) 531-0800**

Table 5.7. Raw data for Positive Input Bias Current 1 @ +5V (A) versus total dose, including the statistical analysis, specification and the status of the testing (pass/fail).

Positive Input Bias Current 1 @ +5V (A)	Total Dose (krad(Si))					24 hr Anneal	168 hr Anneal
	0	10	20	30	50		
Device							
255	9.00E-09	1.06E-08	1.29E-08	1.55E-08	2.11E-08	2.28E-08	2.35E-08
258	1.00E-08	1.18E-08	1.45E-08	1.74E-08	2.37E-08	2.55E-08	2.62E-08
309	9.77E-09	1.16E-08	1.42E-08	1.71E-08	2.27E-08	2.43E-08	2.50E-08
359	9.96E-09	1.19E-08	1.47E-08	1.79E-08	2.38E-08	2.52E-08	2.57E-08
360	9.33E-09	1.10E-08	1.32E-08	1.57E-08	2.09E-08	2.22E-08	2.33E-08
416	9.69E-09	1.13E-08	1.38E-08	1.63E-08	2.13E-08	2.12E-08	1.89E-08
472	9.33E-09	1.09E-08	1.33E-08	1.59E-08	2.08E-08	2.06E-08	1.83E-08
473	9.39E-09	1.10E-08	1.35E-08	1.61E-08	2.14E-08	2.14E-08	1.88E-08
526	9.57E-09	1.14E-08	1.39E-08	1.65E-08	2.22E-08	2.20E-08	1.94E-08
529	9.21E-09	1.11E-08	1.32E-08	1.57E-08	2.11E-08	2.11E-08	1.86E-08
530	9.50E-09	9.58E-09	9.55E-09	9.46E-09	9.50E-09	9.54E-09	9.46E-09
561	9.32E-09	9.27E-09	9.26E-09	9.31E-09	9.27E-09	9.16E-09	9.38E-09
<b>Biased Statistics</b>							
Average Biased	9.61E-09	1.14E-08	1.39E-08	1.67E-08	2.24E-08	2.40E-08	2.47E-08
Std Dev Biased	4.33E-10	5.67E-10	7.95E-10	1.05E-09	1.38E-09	1.45E-09	1.27E-09
Ps90%/90% (+KTL) Biased	1.08E-08	1.29E-08	1.60E-08	1.96E-08	2.62E-08	2.80E-08	2.82E-08
Ps90%/90% (-KTL) Biased	8.42E-09	9.83E-09	1.17E-08	1.38E-08	1.86E-08	2.00E-08	2.13E-08
<b>Un-Biased Statistics</b>							
Average Un-Biased	9.44E-09	1.11E-08	1.35E-08	1.61E-08	2.14E-08	2.13E-08	1.88E-08
Std Dev Un-Biased	1.92E-10	2.10E-10	2.90E-10	3.00E-10	5.08E-10	4.90E-10	4.01E-10
Ps90%/90% (+KTL) Un-Biased	9.96E-09	1.17E-08	1.43E-08	1.69E-08	2.28E-08	2.26E-08	1.99E-08
Ps90%/90% (-KTL) Un-Biased	8.91E-09	1.06E-08	1.28E-08	1.53E-08	2.00E-08	1.99E-08	1.77E-08
<b>Specification MIN</b>	<b>-1.50E-08</b>	<b>-2.00E-08</b>	<b>-2.00E-08</b>	<b>-4.00E-08</b>	<b>-8.00E-08</b>	<b>-8.00E-08</b>	<b>-8.00E-08</b>
Status	PASS	PASS	PASS	PASS	PASS	PASS	PASS
<b>Specification MAX</b>	<b>1.50E-08</b>	<b>2.00E-08</b>	<b>2.00E-08</b>	<b>4.00E-08</b>	<b>8.00E-08</b>	<b>8.00E-08</b>	<b>8.00E-08</b>
Status	PASS	PASS	PASS	PASS	PASS	PASS	PASS

**An ISO 9001:2008 and DSCC Certified Company**

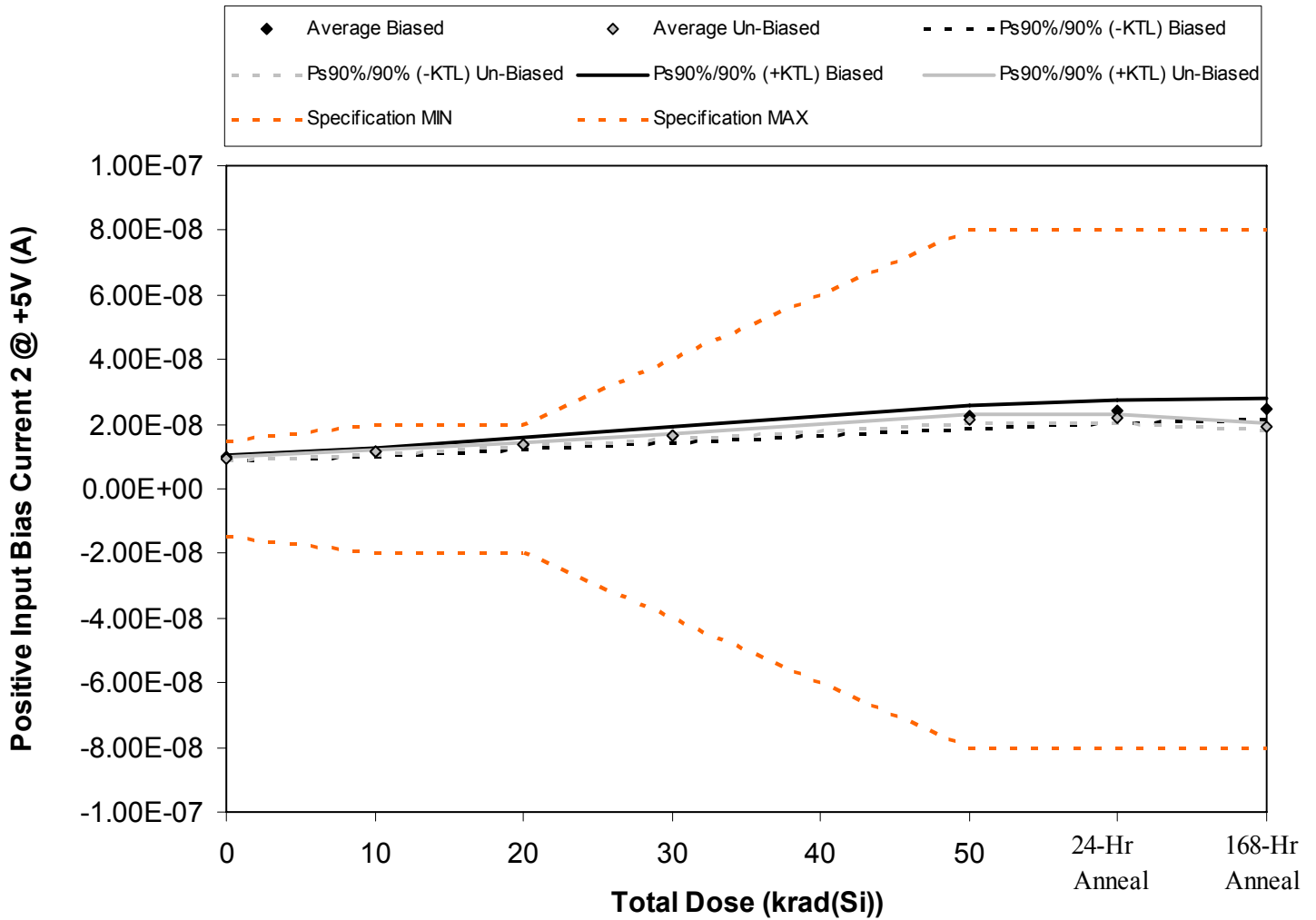

Figure 5.8. Plot of Positive Input Bias Current 2 @ +5V (A) versus total dose. The solid diamonds are the average of the measured data points for the samples irradiated under electrical bias while the shaded diamonds are the average of the measured data points for the samples irradiated with all pins tied to ground. The black lines (solid and/or dashed) are the average of the data points after application of the KTL statistics on the samples irradiated under electrical bias while the gray lines (solid and/or dashed) are the average of the data points after application of the KTL statistics on the samples irradiated in the unbiased condition. The red dotted line(s) are the pre- and/or post-irradiation minimum and/or maximum specification value as defined in the datasheet and/or test plan.



Table 5.8. Raw data for Positive Input Bias Current 2 @ +5V (A) versus total dose, including the statistical analysis, specification and the status of the testing (pass/fail).

Positive Input Bias Current 2 @ +5V (A)	Total Dose (krad(Si))					24 hr Anneal	168 hr Anneal
	0	10	20	30	50		
Device							
255	9.04E-09	1.06E-08	1.30E-08	1.55E-08	2.10E-08	2.28E-08	2.38E-08
258	1.00E-08	1.20E-08	1.45E-08	1.76E-08	2.38E-08	2.56E-08	2.64E-08
309	9.77E-09	1.14E-08	1.42E-08	1.69E-08	2.27E-08	2.43E-08	2.53E-08
359	9.85E-09	1.17E-08	1.47E-08	1.77E-08	2.34E-08	2.48E-08	2.54E-08
360	9.45E-09	1.12E-08	1.35E-08	1.60E-08	2.11E-08	2.26E-08	2.36E-08
416	9.72E-09	1.15E-08	1.39E-08	1.64E-08	2.14E-08	2.14E-08	1.91E-08
472	9.49E-09	1.10E-08	1.33E-08	1.59E-08	2.09E-08	2.11E-08	1.85E-08
473	9.34E-09	1.11E-08	1.36E-08	1.63E-08	2.16E-08	2.19E-08	1.90E-08
526	9.44E-09	1.15E-08	1.39E-08	1.65E-08	2.21E-08	2.23E-08	1.95E-08
529	9.37E-09	1.13E-08	1.36E-08	1.63E-08	2.18E-08	2.18E-08	1.91E-08
530	9.63E-09	9.60E-09	9.61E-09	9.66E-09	9.62E-09	9.65E-09	9.54E-09
561	9.31E-09	9.29E-09	9.34E-09	9.36E-09	9.27E-09	9.23E-09	9.33E-09
<b>Biased Statistics</b>							
Average Biased	9.62E-09	1.14E-08	1.40E-08	1.67E-08	2.24E-08	2.40E-08	2.49E-08
Std Dev Biased	3.85E-10	5.32E-10	7.21E-10	9.79E-10	1.28E-09	1.30E-09	1.17E-09
Ps90%/90% (+KTL) Biased	1.07E-08	1.28E-08	1.59E-08	1.94E-08	2.59E-08	2.76E-08	2.81E-08
Ps90%/90% (-KTL) Biased	8.57E-09	9.91E-09	1.20E-08	1.41E-08	1.89E-08	2.04E-08	2.17E-08
<b>Un-Biased Statistics</b>							
Average Un-Biased	9.47E-09	1.13E-08	1.37E-08	1.63E-08	2.15E-08	2.17E-08	1.90E-08
Std Dev Un-Biased	1.51E-10	2.40E-10	2.65E-10	2.53E-10	4.73E-10	4.69E-10	3.70E-10
Ps90%/90% (+KTL) Un-Biased	9.88E-09	1.19E-08	1.44E-08	1.70E-08	2.28E-08	2.30E-08	2.01E-08
Ps90%/90% (-KTL) Un-Biased	9.06E-09	1.06E-08	1.29E-08	1.56E-08	2.02E-08	2.04E-08	1.80E-08
<b>Specification MIN</b>	<b>-1.50E-08</b>	<b>-2.00E-08</b>	<b>-2.00E-08</b>	<b>-4.00E-08</b>	<b>-8.00E-08</b>	<b>-8.00E-08</b>	<b>-8.00E-08</b>
Status	PASS	PASS	PASS	PASS	PASS	PASS	PASS
<b>Specification MAX</b>	<b>1.50E-08</b>	<b>2.00E-08</b>	<b>2.00E-08</b>	<b>4.00E-08</b>	<b>8.00E-08</b>	<b>8.00E-08</b>	<b>8.00E-08</b>
Status	PASS	PASS	PASS	PASS	PASS	PASS	PASS

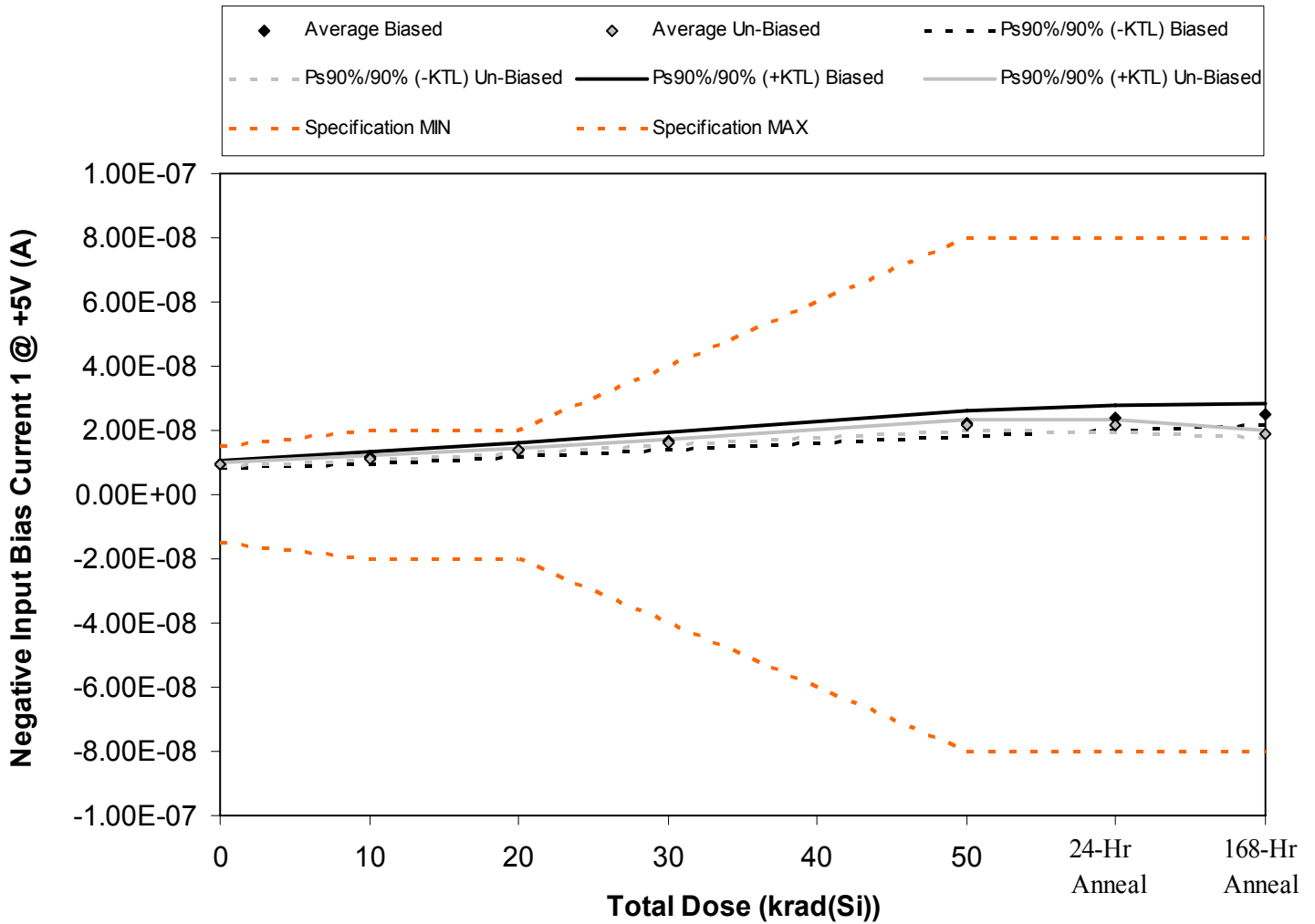

Figure 5.9. Plot of Negative Input Bias Current 1 @ +5V (A) versus total dose. The solid diamonds are the average of the measured data points for the samples irradiated under electrical bias while the shaded diamonds are the average of the measured data points for the samples irradiated with all pins tied to ground. The black lines (solid and/or dashed) are the average of the data points after application of the KTL statistics on the samples irradiated under electrical bias while the gray lines (solid and/or dashed) are the average of the data points after application of the KTL statistics on the samples irradiated in the unbiased condition. The red dotted line(s) are the pre- and/or post-irradiation minimum and/or maximum specification value as defined in the datasheet and/or test plan.





**TID Report  
10-004 100412 R1.0**

**Radiation Assured Devices  
5017 N. 30th Street  
Colorado Springs, CO 80919  
(719) 531-0800**

Table 5.9. Raw data for Negative Input Bias Current 1 @ +5V (A) versus total dose, including the statistical analysis, specification and the status of the testing (pass/fail).

Negative Input Bias Current 1 @ +5V (A)	Total Dose (krad(Si))					24 hr Anneal	168 hr Anneal
	0	10	20	30	50		
Device							
255	8.99E-09	1.05E-08	1.28E-08	1.55E-08	2.12E-08	2.28E-08	2.37E-08
258	9.96E-09	1.19E-08	1.45E-08	1.75E-08	2.37E-08	2.54E-08	2.61E-08
309	9.85E-09	1.18E-08	1.44E-08	1.72E-08	2.30E-08	2.45E-08	2.56E-08
359	9.88E-09	1.19E-08	1.47E-08	1.77E-08	2.36E-08	2.51E-08	2.56E-08
360	9.26E-09	1.10E-08	1.31E-08	1.56E-08	2.07E-08	2.23E-08	2.35E-08
416	9.74E-09	1.14E-08	1.38E-08	1.63E-08	2.13E-08	2.12E-08	1.89E-08
472	9.34E-09	1.09E-08	1.33E-08	1.58E-08	2.09E-08	2.06E-08	1.86E-08
473	9.44E-09	1.11E-08	1.37E-08	1.63E-08	2.18E-08	2.17E-08	1.90E-08
526	9.65E-09	1.17E-08	1.41E-08	1.67E-08	2.24E-08	2.23E-08	1.96E-08
529	9.20E-09	1.11E-08	1.36E-08	1.61E-08	2.17E-08	2.13E-08	1.87E-08
530	9.66E-09	9.67E-09	9.63E-09	9.70E-09	9.64E-09	9.74E-09	9.72E-09
561	9.29E-09	9.39E-09	9.28E-09	9.34E-09	9.33E-09	9.24E-09	9.34E-09
<b>Biased Statistics</b>							
Average Biased	9.59E-09	1.14E-08	1.39E-08	1.67E-08	2.24E-08	2.40E-08	2.49E-08
Std Dev Biased	4.35E-10	6.29E-10	8.57E-10	1.08E-09	1.42E-09	1.41E-09	1.20E-09
Ps90%/90% (+KTL) Biased	1.08E-08	1.31E-08	1.62E-08	1.97E-08	2.63E-08	2.79E-08	2.82E-08
Ps90%/90% (-KTL) Biased	8.39E-09	9.68E-09	1.15E-08	1.38E-08	1.85E-08	2.02E-08	2.16E-08
<b>Un-Biased Statistics</b>							
Average Un-Biased	9.47E-09	1.12E-08	1.37E-08	1.62E-08	2.16E-08	2.14E-08	1.89E-08
Std Dev Un-Biased	2.21E-10	3.11E-10	2.95E-10	3.30E-10	5.80E-10	6.44E-10	3.84E-10
Ps90%/90% (+KTL) Un-Biased	1.01E-08	1.21E-08	1.45E-08	1.71E-08	2.32E-08	2.32E-08	2.00E-08
Ps90%/90% (-KTL) Un-Biased	8.87E-09	1.04E-08	1.29E-08	1.53E-08	2.00E-08	1.97E-08	1.79E-08
<b>Specification MIN</b>	<b>-1.50E-08</b>	<b>-2.00E-08</b>	<b>-2.00E-08</b>	<b>-4.00E-08</b>	<b>-8.00E-08</b>	<b>-8.00E-08</b>	<b>-8.00E-08</b>
Status	PASS	PASS	PASS	PASS	PASS	PASS	PASS
<b>Specification MAX</b>	<b>1.50E-08</b>	<b>2.00E-08</b>	<b>2.00E-08</b>	<b>4.00E-08</b>	<b>8.00E-08</b>	<b>8.00E-08</b>	<b>8.00E-08</b>
Status	PASS	PASS	PASS	PASS	PASS	PASS	PASS

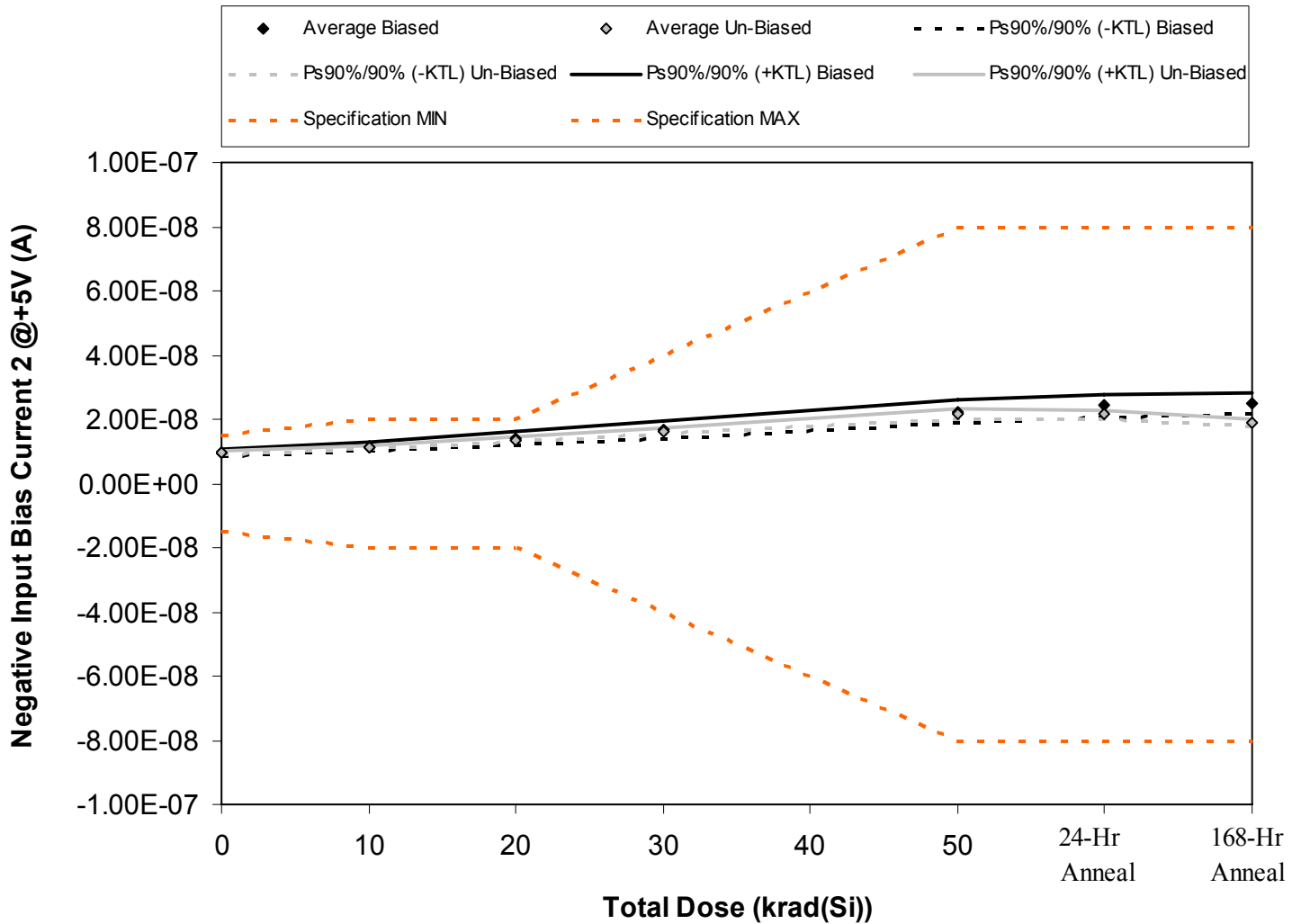

Figure 5.10. Plot of Negative Input Bias Current 2 @+5V (A) versus total dose. The solid diamonds are the average of the measured data points for the samples irradiated under electrical bias while the shaded diamonds are the average of the measured data points for the samples irradiated with all pins tied to ground. The black lines (solid and/or dashed) are the average of the data points after application of the KTL statistics on the samples irradiated under electrical bias while the gray lines (solid and/or dashed) are the average of the data points after application of the KTL statistics on the samples irradiated in the unbiased condition. The red dotted line(s) are the pre- and/or post-irradiation minimum and/or maximum specification value as defined in the datasheet and/or test plan.



**TID Report  
10-004 100412 R1.0**

**Radiation Assured Devices  
5017 N. 30th Street  
Colorado Springs, CO 80919  
(719) 531-0800**

Table 5.10. Raw data for Negative Input Bias Current 2 @+5V (A) versus total dose, including the statistical analysis, specification and the status of the testing (pass/fail).

Negative Input Bias Current 2 @+5V (A)	Total Dose (krad(Si))					24 hr Anneal	168 hr Anneal
	0	10	20	30	50		
Device							
255	9.07E-09	1.07E-08	1.29E-08	1.54E-08	2.12E-08	2.30E-08	2.38E-08
258	1.01E-08	1.21E-08	1.46E-08	1.76E-08	2.39E-08	2.58E-08	2.64E-08
309	9.77E-09	1.16E-08	1.44E-08	1.71E-08	2.28E-08	2.44E-08	2.53E-08
359	1.01E-08	1.19E-08	1.48E-08	1.77E-08	2.34E-08	2.49E-08	2.56E-08
360	9.53E-09	1.12E-08	1.35E-08	1.60E-08	2.10E-08	2.27E-08	2.38E-08
416	9.74E-09	1.13E-08	1.38E-08	1.62E-08	2.12E-08	2.12E-08	1.91E-08
472	9.38E-09	1.11E-08	1.34E-08	1.60E-08	2.09E-08	2.09E-08	1.86E-08
473	9.37E-09	1.12E-08	1.37E-08	1.64E-08	2.18E-08	2.17E-08	1.91E-08
526	9.74E-09	1.15E-08	1.40E-08	1.67E-08	2.24E-08	2.23E-08	1.97E-08
529	9.23E-09	1.13E-08	1.35E-08	1.60E-08	2.15E-08	2.13E-08	1.88E-08
530	9.73E-09	9.64E-09	9.62E-09	9.57E-09	9.63E-09	9.67E-09	9.67E-09
561	9.44E-09	9.54E-09	9.48E-09	9.56E-09	9.58E-09	9.49E-09	9.57E-09
<b>Biased Statistics</b>							
Average Biased	9.70E-09	1.15E-08	1.40E-08	1.67E-08	2.25E-08	2.41E-08	2.50E-08
Std Dev Biased	4.22E-10	5.80E-10	7.93E-10	1.00E-09	1.30E-09	1.31E-09	1.16E-09
Ps90%/90% (+KTL) Biased	1.09E-08	1.31E-08	1.62E-08	1.95E-08	2.60E-08	2.77E-08	2.81E-08
Ps90%/90% (-KTL) Biased	8.55E-09	9.90E-09	1.19E-08	1.40E-08	1.89E-08	2.05E-08	2.18E-08
<b>Un-Biased Statistics</b>							
Average Un-Biased	9.49E-09	1.13E-08	1.37E-08	1.63E-08	2.16E-08	2.15E-08	1.91E-08
Std Dev Un-Biased	2.34E-10	1.57E-10	2.29E-10	2.90E-10	5.81E-10	5.50E-10	4.07E-10
Ps90%/90% (+KTL) Un-Biased	1.01E-08	1.17E-08	1.43E-08	1.71E-08	2.31E-08	2.30E-08	2.02E-08
Ps90%/90% (-KTL) Un-Biased	8.85E-09	1.08E-08	1.31E-08	1.55E-08	2.00E-08	2.00E-08	1.80E-08
<b>Specification MIN</b>	<b>-1.50E-08</b>	<b>-2.00E-08</b>	<b>-2.00E-08</b>	<b>-4.00E-08</b>	<b>-8.00E-08</b>	<b>-8.00E-08</b>	<b>-8.00E-08</b>
Status	PASS	PASS	PASS	PASS	PASS	PASS	PASS
<b>Specification MAX</b>	<b>1.50E-08</b>	<b>2.00E-08</b>	<b>2.00E-08</b>	<b>4.00E-08</b>	<b>8.00E-08</b>	<b>8.00E-08</b>	<b>8.00E-08</b>
Status	PASS	PASS	PASS	PASS	PASS	PASS	PASS

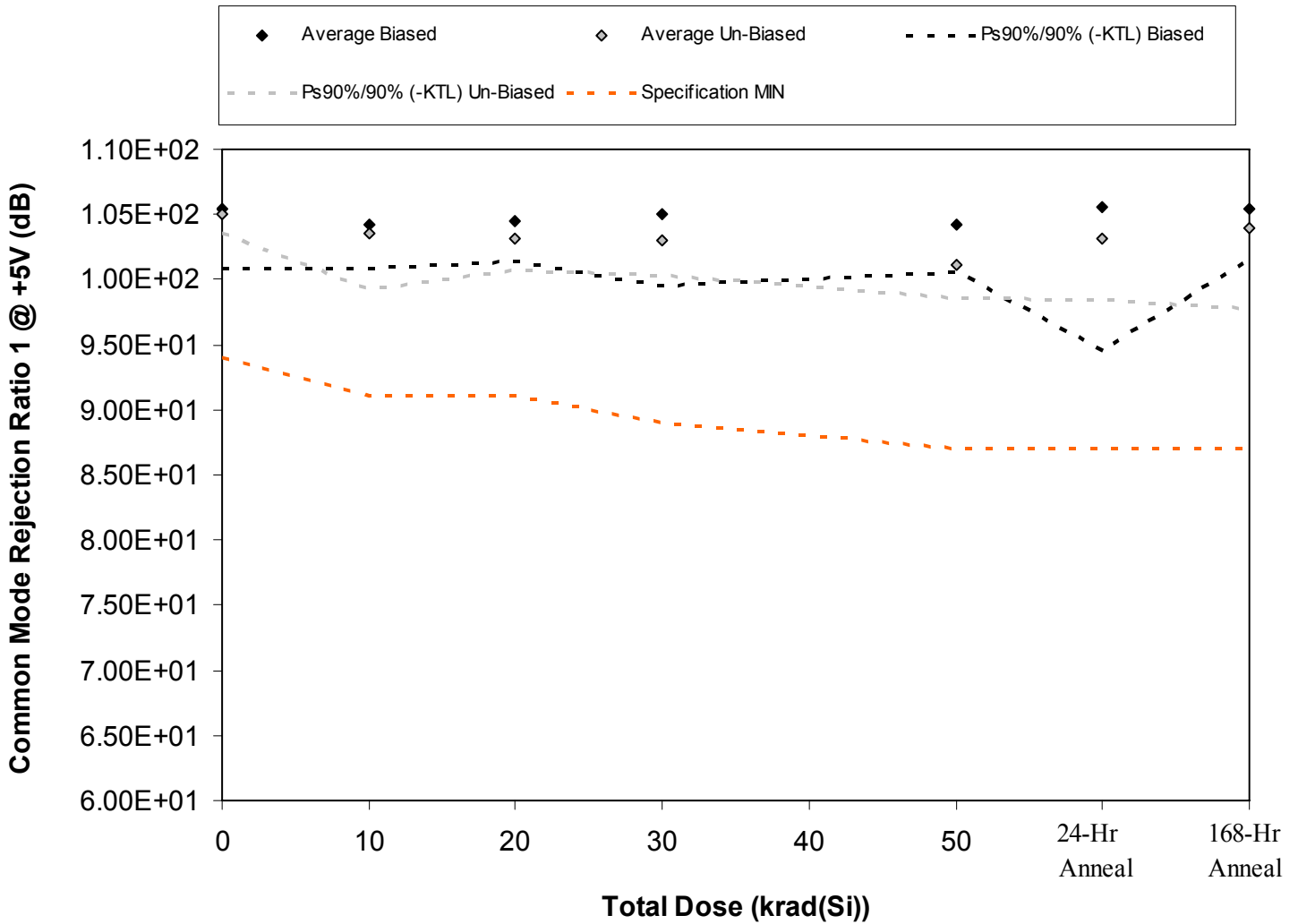

Figure 5.11. Plot of Common Mode Rejection Ratio 1 @ +5V (dB) versus total dose. The solid diamonds are the average of the measured data points for the samples irradiated under electrical bias while the shaded diamonds are the average of the measured data points for the samples irradiated with all pins tied to ground. The black lines (solid and/or dashed) are the average of the data points after application of the KTL statistics on the samples irradiated under electrical bias while the gray lines (solid and/or dashed) are the average of the data points after application of the KTL statistics on the samples irradiated in the unbiased condition. The red dotted line(s) are the pre- and/or post-irradiation minimum and/or maximum specification value as defined in the datasheet and/or test plan.



**TID Report  
10-004 100412 R1.0**

**Radiation Assured Devices  
5017 N. 30th Street  
Colorado Springs, CO 80919  
(719) 531-0800**

Table 5.11. Raw data for Common Mode Rejection Ratio 1 @ +5V (dB) versus total dose, including the statistical analysis, specification and the status of the testing (pass/fail).

Common Mode Rejection Ratio 1 @ +5V (dB)	Total Dose (krad(Si))					24 hr Anneal	168 hr Anneal
	0	10	20	30	50		
Device							
255	1.06E+02	1.05E+02	1.06E+02	1.05E+02	1.03E+02	1.12E+02	1.05E+02
258	1.03E+02	1.02E+02	1.05E+02	1.04E+02	1.04E+02	1.03E+02	1.03E+02
309	1.05E+02	1.05E+02	1.05E+02	1.06E+02	1.05E+02	1.08E+02	1.06E+02
359	1.06E+02	1.04E+02	1.04E+02	1.03E+02	1.06E+02	1.03E+02	1.06E+02
360	1.07E+02	1.05E+02	1.03E+02	1.08E+02	1.03E+02	1.03E+02	1.07E+02
416	1.05E+02	1.05E+02	1.03E+02	1.02E+02	1.02E+02	1.02E+02	1.02E+02
472	1.05E+02	1.05E+02	1.02E+02	1.02E+02	1.02E+02	1.03E+02	1.02E+02
473	1.05E+02	1.02E+02	1.03E+02	1.04E+02	9.97E+01	1.02E+02	1.03E+02
526	1.06E+02	1.02E+02	1.04E+02	1.04E+02	1.02E+02	1.02E+02	1.08E+02
529	1.04E+02	1.04E+02	1.03E+02	1.04E+02	1.01E+02	1.06E+02	1.05E+02
530	1.04E+02	1.04E+02	1.04E+02	1.02E+02	1.03E+02	1.04E+02	1.05E+02
561	1.04E+02	1.04E+02	1.05E+02	1.05E+02	1.07E+02	1.08E+02	1.05E+02
<b>Biased Statistics</b>							
Average Biased	1.05E+02	1.04E+02	1.05E+02	1.05E+02	1.04E+02	1.06E+02	1.05E+02
Std Dev Biased	1.65E+00	1.25E+00	1.15E+00	2.01E+00	1.28E+00	4.01E+00	1.44E+00
Ps90%/90% (+KTL) Biased	1.10E+02	1.08E+02	1.08E+02	1.10E+02	1.08E+02	1.17E+02	1.09E+02
Ps90%/90% (-KTL) Biased	1.01E+02	1.01E+02	1.01E+02	9.95E+01	1.01E+02	9.46E+01	1.02E+02
<b>Un-Biased Statistics</b>							
Average Un-Biased	1.05E+02	1.04E+02	1.03E+02	1.03E+02	1.01E+02	1.03E+02	1.04E+02
Std Dev Un-Biased	5.30E-01	1.56E+00	8.93E-01	9.78E-01	9.12E-01	1.72E+00	2.28E+00
Ps90%/90% (+KTL) Un-Biased	1.06E+02	1.08E+02	1.06E+02	1.06E+02	1.04E+02	1.08E+02	1.10E+02
Ps90%/90% (-KTL) Un-Biased	1.04E+02	9.93E+01	1.01E+02	1.00E+02	9.86E+01	9.84E+01	9.78E+01
<b>Specification MIN</b>	<b>9.40E+01</b>	<b>9.10E+01</b>	<b>9.10E+01</b>	<b>8.90E+01</b>	<b>8.70E+01</b>	<b>8.70E+01</b>	<b>8.70E+01</b>
Status	PASS	PASS	PASS	PASS	PASS	PASS	PASS

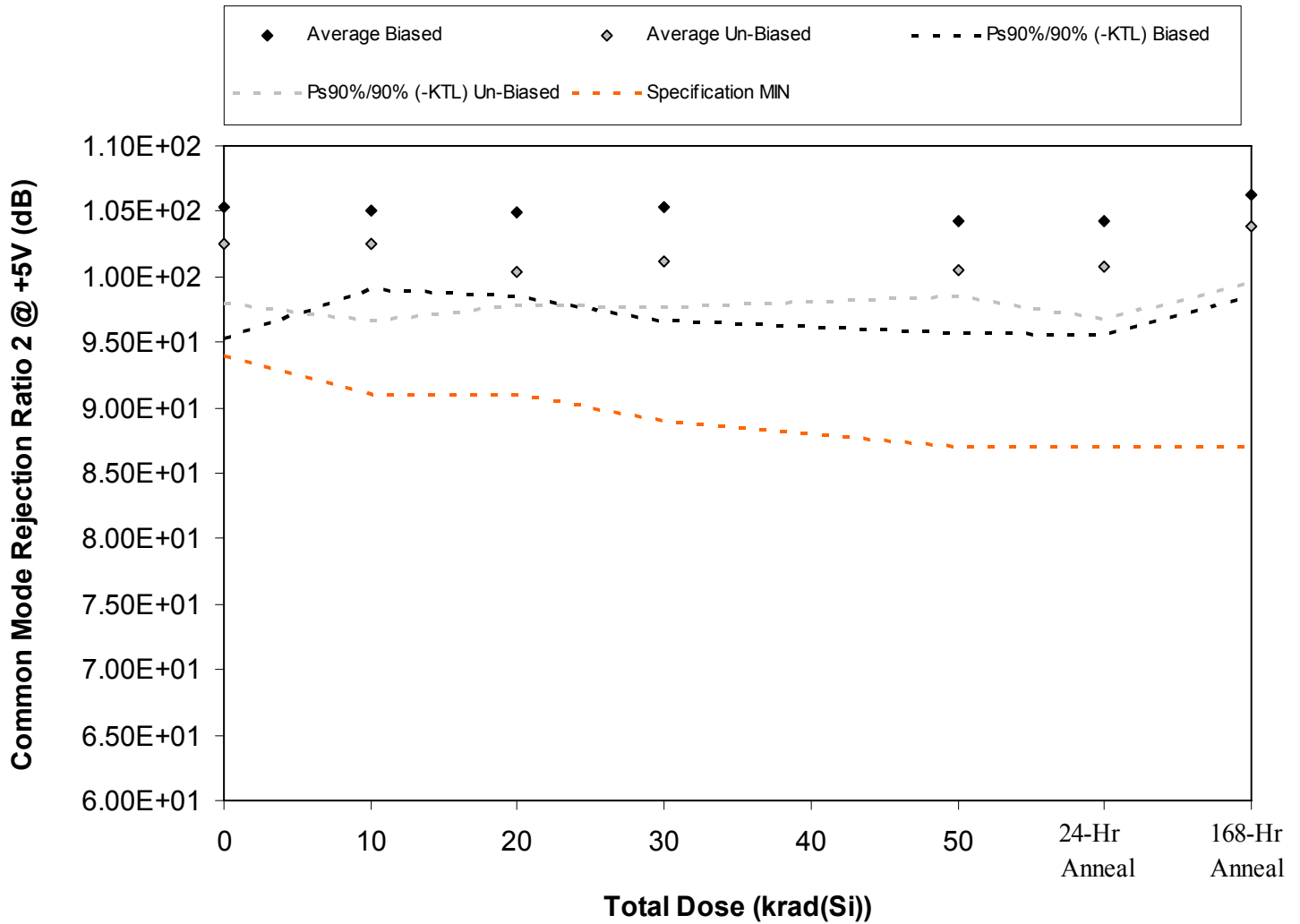

Figure 5.12. Plot of Common Mode Rejection Ratio 2 @ +5V (dB) versus total dose. The solid diamonds are the average of the measured data points for the samples irradiated under electrical bias while the shaded diamonds are the average of the measured data points for the samples irradiated with all pins tied to ground. The black lines (solid and/or dashed) are the average of the data points after application of the KTL statistics on the samples irradiated under electrical bias while the gray lines (solid and/or dashed) are the average of the data points after application of the KTL statistics on the samples irradiated in the unbiased condition. The red dotted line(s) are the pre- and/or post-irradiation minimum and/or maximum specification value as defined in the datasheet and/or test plan.



**TID Report  
10-004 100412 R1.0**

**Radiation Assured Devices  
5017 N. 30th Street  
Colorado Springs, CO 80919  
(719) 531-0800**

Table 5.12. Raw data for Common Mode Rejection Ratio 2 @ +5V (dB) versus total dose, including the statistical analysis, specification and the status of the testing (pass/fail).

Common Mode Rejection Ratio 2 @ +5V (dB)	Total Dose (krad(Si))					24 hr Anneal	168 hr Anneal
	0	10	20	30	50		
Device							
255	1.03E+02	1.08E+02	1.03E+02	1.02E+02	1.02E+02	1.03E+02	1.10E+02
258	1.04E+02	1.02E+02	1.02E+02	1.03E+02	1.02E+02	1.04E+02	1.06E+02
309	1.12E+02	1.07E+02	1.08E+02	1.10E+02	1.07E+02	1.10E+02	1.05E+02
359	1.03E+02	1.05E+02	1.06E+02	1.07E+02	1.08E+02	1.03E+02	1.08E+02
360	1.05E+02	1.04E+02	1.05E+02	1.05E+02	1.03E+02	1.02E+02	1.02E+02
416	1.04E+02	1.03E+02	1.00E+02	1.01E+02	1.01E+02	1.02E+02	1.04E+02
472	1.02E+02	1.00E+02	9.95E+01	9.94E+01	9.99E+01	9.92E+01	1.03E+02
473	1.04E+02	1.05E+02	1.02E+02	1.02E+02	1.01E+02	1.02E+02	1.06E+02
526	1.02E+02	1.00E+02	9.95E+01	1.01E+02	1.00E+02	9.93E+01	1.04E+02
529	1.00E+02	1.04E+02	1.01E+02	1.03E+02	9.97E+01	1.02E+02	1.03E+02
530	1.06E+02	1.08E+02	1.06E+02	1.05E+02	1.06E+02	1.05E+02	1.06E+02
561	1.04E+02	1.02E+02	1.04E+02	1.03E+02	1.06E+02	1.02E+02	1.04E+02
<b>Biased Statistics</b>							
Average Biased	1.05E+02	1.05E+02	1.05E+02	1.05E+02	1.04E+02	1.04E+02	1.06E+02
Std Dev Biased	3.69E+00	2.20E+00	2.33E+00	3.19E+00	3.13E+00	3.20E+00	2.83E+00
Ps90%/90% (+KTL) Biased	1.16E+02	1.11E+02	1.11E+02	1.14E+02	1.13E+02	1.13E+02	1.14E+02
Ps90%/90% (-KTL) Biased	9.52E+01	9.91E+01	9.85E+01	9.66E+01	9.57E+01	9.55E+01	9.85E+01
<b>Un-Biased Statistics</b>							
Average Un-Biased	1.02E+02	1.02E+02	1.00E+02	1.01E+02	1.00E+02	1.01E+02	1.04E+02
Std Dev Un-Biased	1.63E+00	2.12E+00	9.44E-01	1.25E+00	7.39E-01	1.49E+00	1.55E+00
Ps90%/90% (+KTL) Un-Biased	1.07E+02	1.08E+02	1.03E+02	1.05E+02	1.02E+02	1.05E+02	1.08E+02
Ps90%/90% (-KTL) Un-Biased	9.80E+01	9.67E+01	9.78E+01	9.77E+01	9.84E+01	9.68E+01	9.96E+01
<b>Specification MIN</b>	<b>9.40E+01</b>	<b>9.10E+01</b>	<b>9.10E+01</b>	<b>8.90E+01</b>	<b>8.70E+01</b>	<b>8.70E+01</b>	<b>8.70E+01</b>
Status	PASS	PASS	PASS	PASS	PASS	PASS	PASS

**An ISO 9001:2008 and DSCC Certified Company**

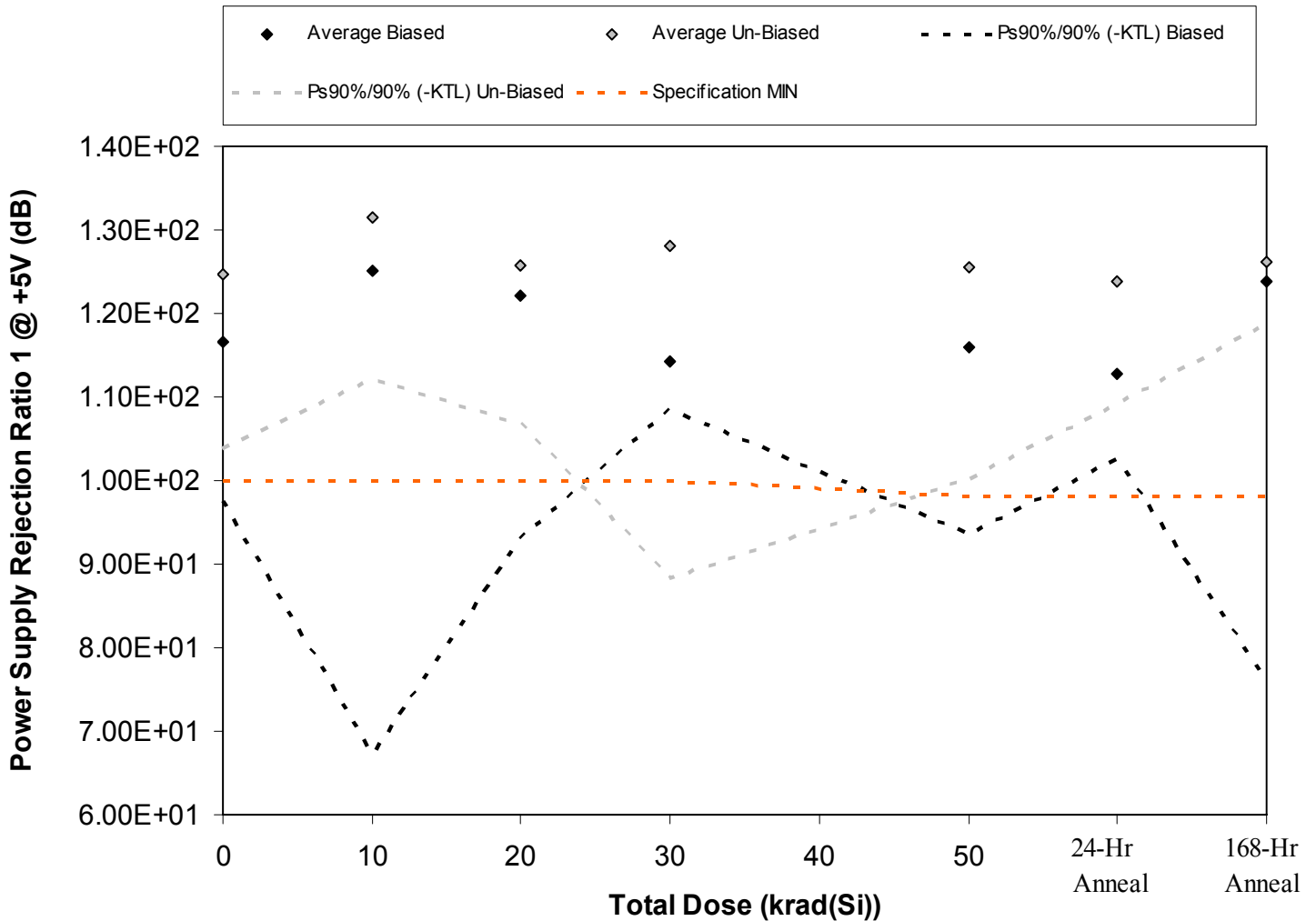

Figure 5.13. Plot of Power Supply Rejection Ratio 1 @ +5V (dB) versus total dose. The solid diamonds are the average of the measured data points for the samples irradiated under electrical bias while the shaded diamonds are the average of the measured data points for the samples irradiated with all pins tied to ground. The black lines (solid and/or dashed) are the average of the data points after application of the KTL statistics on the samples irradiated under electrical bias while the gray lines (solid and/or dashed) are the average of the data points after application of the KTL statistics on the samples irradiated in the unbiased condition. The red dotted line(s) are the pre- and/or post-irradiation minimum and/or maximum specification value as defined in the datasheet and/or test plan.





**TID Report  
10-004 100412 R1.0**

**Radiation Assured Devices  
5017 N. 30th Street  
Colorado Springs, CO 80919  
(719) 531-0800**

Table 5.13. Raw data for Power Supply Rejection Ratio 1 @ +5V (dB) versus total dose, including the statistical analysis, specification and the status of the testing (pass/fail).

Power Supply Rejection Ratio 1 @ +5V (dB)	Total Dose (krad(Si))					24 hr Anneal	168 hr Anneal
	0	10	20	30	50		
Device							
255	1.13E+02	1.14E+02	1.29E+02	1.16E+02	1.11E+02	1.11E+02	1.16E+02
258	1.09E+02	1.11E+02	1.13E+02	1.12E+02	1.11E+02	1.09E+02	1.11E+02
309	1.24E+02	1.62E+02	1.35E+02	1.15E+02	1.30E+02	1.18E+02	1.55E+02
359	1.12E+02	1.14E+02	1.10E+02	1.16E+02	1.12E+02	1.12E+02	1.18E+02
360	1.24E+02	1.24E+02	1.23E+02	1.12E+02	1.16E+02	1.15E+02	1.20E+02
416	1.32E+02	1.32E+02	1.35E+02	1.40E+02	1.26E+02	1.22E+02	1.26E+02
472	1.16E+02	1.34E+02	1.26E+02	1.16E+02	1.17E+02	1.17E+02	1.23E+02
473	1.29E+02	1.40E+02	1.20E+02	1.19E+02	1.35E+02	1.29E+02	1.24E+02
526	1.16E+02	1.21E+02	1.29E+02	1.17E+02	1.15E+02	1.22E+02	1.29E+02
529	1.29E+02	1.31E+02	1.19E+02	1.47E+02	1.33E+02	1.30E+02	1.28E+02
530	1.20E+02	1.20E+02	1.21E+02	1.12E+02	1.21E+02	1.23E+02	1.16E+02
561	1.30E+02	1.28E+02	1.43E+02	1.36E+02	1.26E+02	1.30E+02	1.35E+02
<b>Biased Statistics</b>							
Average Biased	1.17E+02	1.25E+02	1.22E+02	1.14E+02	1.16E+02	1.13E+02	1.24E+02
Std Dev Biased	6.96E+00	2.11E+01	1.06E+01	2.07E+00	8.16E+00	3.72E+00	1.75E+01
Ps90%/90% (+KTL) Biased	1.36E+02	1.83E+02	1.51E+02	1.20E+02	1.38E+02	1.23E+02	1.72E+02
Ps90%/90% (-KTL) Biased	9.75E+01	6.71E+01	9.29E+01	1.08E+02	9.35E+01	1.03E+02	7.59E+01
<b>Un-Biased Statistics</b>							
Average Un-Biased	1.25E+02	1.32E+02	1.26E+02	1.28E+02	1.25E+02	1.24E+02	1.26E+02
Std Dev Un-Biased	7.60E+00	7.05E+00	6.93E+00	1.45E+01	9.22E+00	5.38E+00	2.68E+00
Ps90%/90% (+KTL) Un-Biased	1.46E+02	1.51E+02	1.45E+02	1.68E+02	1.51E+02	1.39E+02	1.33E+02
Ps90%/90% (-KTL) Un-Biased	1.04E+02	1.12E+02	1.07E+02	8.83E+01	1.00E+02	1.09E+02	1.19E+02
<b>Specification MIN</b>	<b>1.00E+02</b>	<b>1.00E+02</b>	<b>1.00E+02</b>	<b>1.00E+02</b>	<b>9.80E+01</b>	<b>9.80E+01</b>	<b>9.80E+01</b>
Status	PASS	PASS	PASS	PASS	PASS	PASS	PASS

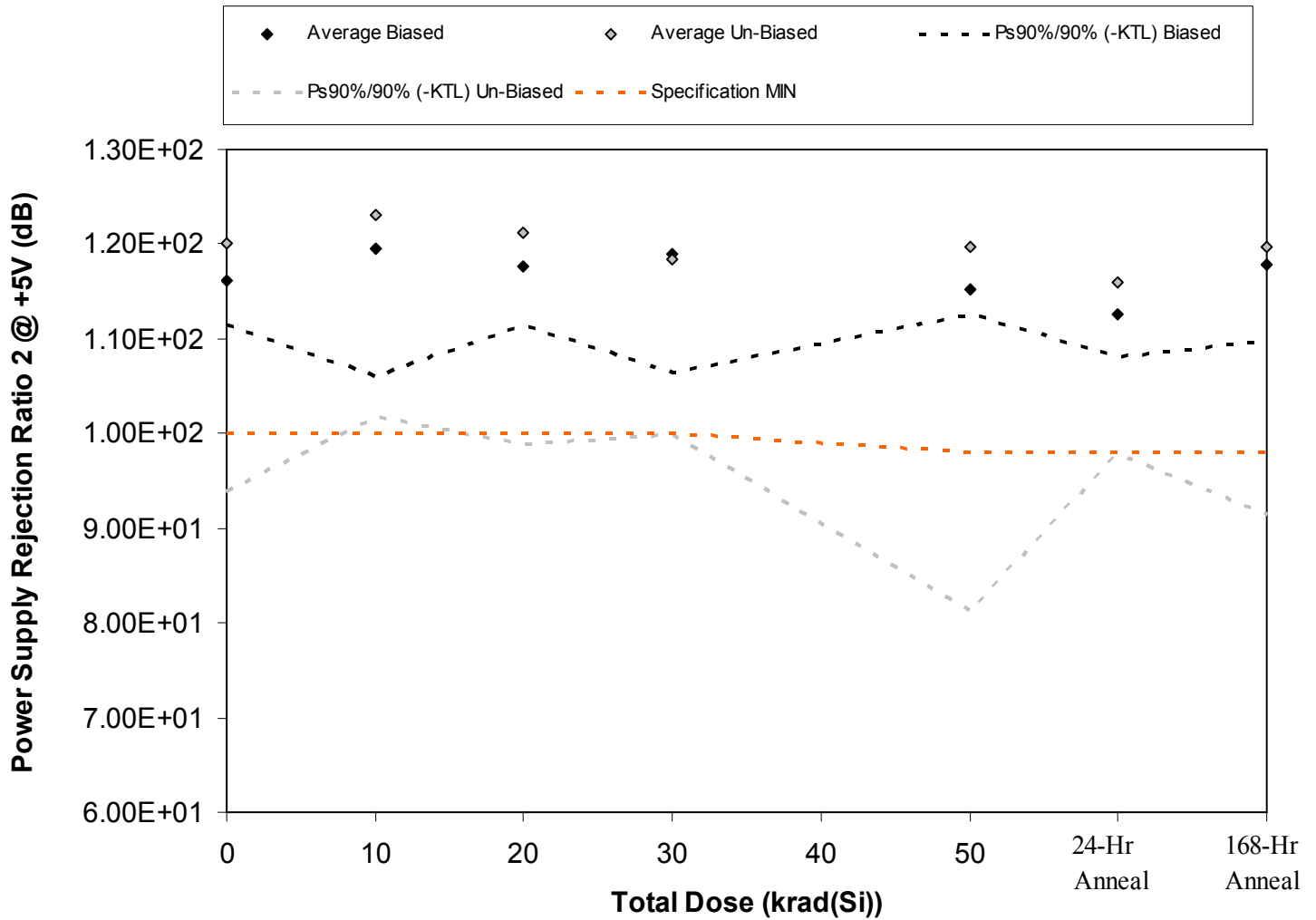

Figure 5.14. Plot of Power Supply Rejection Ratio 2 @ +5V (dB) versus total dose. The solid diamonds are the average of the measured data points for the samples irradiated under electrical bias while the shaded diamonds are the average of the measured data points for the samples irradiated with all pins tied to ground. The black lines (solid and/or dashed) are the average of the data points after application of the KTL statistics on the samples irradiated under electrical bias while the gray lines (solid and/or dashed) are the average of the data points after application of the KTL statistics on the samples irradiated in the unbiased condition. The red dotted line(s) are the pre- and/or post-irradiation minimum and/or maximum specification value as defined in the datasheet and/or test plan.



**TID Report  
10-004 100412 R1.0**

**Radiation Assured Devices  
5017 N. 30th Street  
Colorado Springs, CO 80919  
(719) 531-0800**

Table 5.14. Raw data for Power Supply Rejection Ratio 2 @ +5V (dB) versus total dose, including the statistical analysis, specification and the status of the testing (pass/fail).

Power Supply Rejection Ratio 2 @ +5V (dB)	Total Dose (krad(Si))					24 hr Anneal	168 hr Anneal
	0	10	20	30	50		
Device							
255	1.19E+02	1.15E+02	1.14E+02	1.14E+02	1.14E+02	1.12E+02	1.16E+02
258	1.15E+02	1.18E+02	1.19E+02	1.23E+02	1.16E+02	1.11E+02	1.16E+02
309	1.17E+02	1.19E+02	1.17E+02	1.16E+02	1.14E+02	1.13E+02	1.20E+02
359	1.15E+02	1.28E+02	1.18E+02	1.25E+02	1.16E+02	1.15E+02	1.22E+02
360	1.16E+02	1.17E+02	1.20E+02	1.17E+02	1.15E+02	1.12E+02	1.15E+02
416	1.16E+02	1.33E+02	1.22E+02	1.17E+02	1.14E+02	1.13E+02	1.14E+02
472	1.36E+02	1.26E+02	1.27E+02	1.30E+02	1.44E+02	1.26E+02	1.37E+02
473	1.20E+02	1.21E+02	1.14E+02	1.14E+02	1.11E+02	1.13E+02	1.15E+02
526	1.11E+02	1.12E+02	1.12E+02	1.13E+02	1.11E+02	1.09E+02	1.12E+02
529	1.18E+02	1.23E+02	1.31E+02	1.17E+02	1.17E+02	1.19E+02	1.21E+02
530	1.15E+02	1.17E+02	1.14E+02	1.14E+02	1.17E+02	1.14E+02	1.21E+02
561	1.29E+02	1.30E+02	1.24E+02	1.22E+02	1.24E+02	1.22E+02	1.20E+02
<b>Biased Statistics</b>							
Average Biased	1.16E+02	1.19E+02	1.18E+02	1.19E+02	1.15E+02	1.13E+02	1.18E+02
Std Dev Biased	1.74E+00	4.89E+00	2.26E+00	4.54E+00	9.65E-01	1.66E+00	2.93E+00
Ps90%/90% (+KTL) Biased	1.21E+02	1.33E+02	1.24E+02	1.31E+02	1.18E+02	1.17E+02	1.26E+02
Ps90%/90% (-KTL) Biased	1.11E+02	1.06E+02	1.11E+02	1.06E+02	1.13E+02	1.08E+02	1.10E+02
<b>Un-Biased Statistics</b>							
Average Un-Biased	1.20E+02	1.23E+02	1.21E+02	1.18E+02	1.20E+02	1.16E+02	1.20E+02
Std Dev Un-Biased	9.51E+00	7.81E+00	8.10E+00	6.70E+00	1.40E+01	6.61E+00	1.03E+01
Ps90%/90% (+KTL) Un-Biased	1.46E+02	1.44E+02	1.43E+02	1.37E+02	1.58E+02	1.34E+02	1.48E+02
Ps90%/90% (-KTL) Un-Biased	9.39E+01	1.02E+02	9.90E+01	1.00E+02	8.12E+01	9.79E+01	9.15E+01
<b>Specification MIN</b>	<b>1.00E+02</b>	<b>1.00E+02</b>	<b>1.00E+02</b>	<b>1.00E+02</b>	<b>9.80E+01</b>	<b>9.80E+01</b>	<b>9.80E+01</b>
Status	PASS	PASS	PASS	PASS	PASS	PASS	PASS

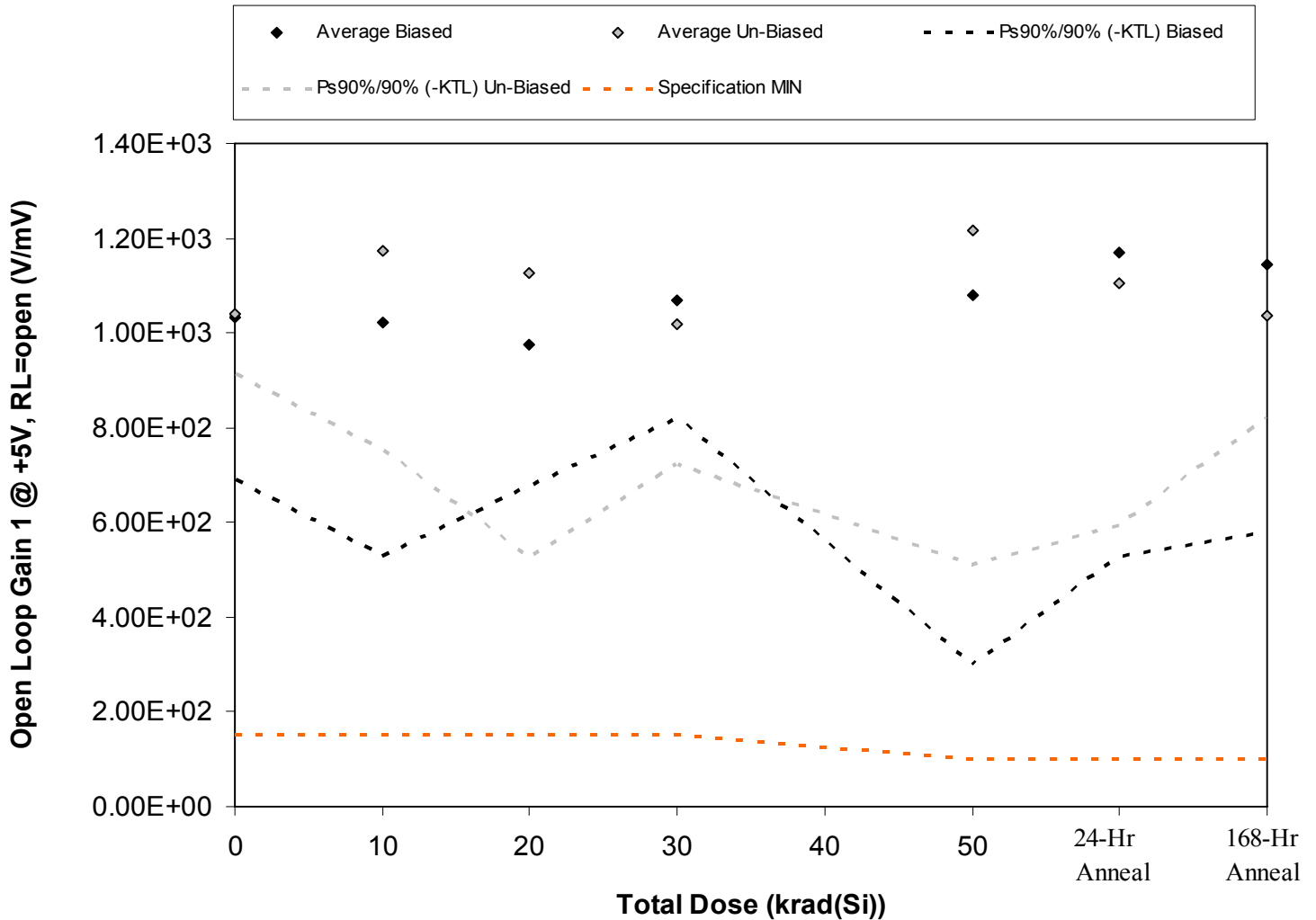

Figure 5.15. Plot of Open Loop Gain 1 @ +5V, RL=open (V/mV) versus total dose. The solid diamonds are the average of the measured data points for the samples irradiated under electrical bias while the shaded diamonds are the average of the measured data points for the samples irradiated with all pins tied to ground. The black lines (solid and/or dashed) are the average of the data points after application of the KTL statistics on the samples irradiated under electrical bias while the gray lines (solid and/or dashed) are the average of the data points after application of the KTL statistics on the samples irradiated in the unbiased condition. The red dotted line(s) are the pre- and/or post-irradiation minimum and/or maximum specification value as defined in the datasheet and/or test plan.



**TID Report  
10-004 100412 R1.0**

**Radiation Assured Devices  
5017 N. 30th Street  
Colorado Springs, CO 80919  
(719) 531-0800**

Table 5.15. Raw data for Open Loop Gain 1 @ +5V, RL=open (V/mV) versus total dose, including the statistical analysis, specification and the status of the testing (pass/fail).

Open Loop Gain 1 @ +5V, RL=open (V/mV)	Total Dose (krad(Si))					24 hr Anneal	168 hr Anneal
	0	10	20	30	50		
Device							
255	1.00E+03	1.33E+03	1.11E+03	1.10E+03	1.52E+03	1.57E+03	1.45E+03
258	1.13E+03	8.97E+02	9.53E+02	9.90E+02	8.24E+02	1.10E+03	9.87E+02
309	1.18E+03	9.81E+02	1.03E+03	9.96E+02	8.71E+02	1.05E+03	9.31E+02
359	8.75E+02	1.02E+03	8.22E+02	1.05E+03	9.86E+02	9.67E+02	1.21E+03
360	9.66E+02	8.88E+02	9.52E+02	1.21E+03	1.19E+03	1.16E+03	1.15E+03
416	1.03E+03	9.82E+02	1.01E+03	1.04E+03	1.32E+03	8.07E+02	1.13E+03
472	9.76E+02	1.12E+03	1.28E+03	1.01E+03	1.11E+03	1.18E+03	9.66E+02
473	1.03E+03	1.13E+03	9.35E+02	9.71E+02	1.17E+03	1.31E+03	1.02E+03
526	1.06E+03	1.38E+03	1.44E+03	8.86E+02	1.59E+03	1.08E+03	1.12E+03
529	1.10E+03	1.26E+03	9.79E+02	1.18E+03	8.96E+02	1.14E+03	9.63E+02
530	1.03E+03	1.03E+03	1.12E+03	1.01E+03	1.07E+03	1.05E+03	8.72E+02
561	9.49E+02	1.11E+03	1.00E+03	1.09E+03	1.21E+03	1.16E+03	1.07E+03
<b>Biased Statistics</b>							
Average Biased	1.03E+03	1.02E+03	9.75E+02	1.07E+03	1.08E+03	1.17E+03	1.15E+03
Std Dev Biased	1.24E+02	1.80E+02	1.08E+02	9.05E+01	2.85E+02	2.34E+02	2.06E+02
Ps90%/90% (+KTL) Biased	1.37E+03	1.52E+03	1.27E+03	1.32E+03	1.86E+03	1.81E+03	1.71E+03
Ps90%/90% (-KTL) Biased	6.92E+02	5.29E+02	6.78E+02	8.21E+02	2.98E+02	5.29E+02	5.81E+02
<b>Un-Biased Statistics</b>							
Average Un-Biased	1.04E+03	1.17E+03	1.13E+03	1.02E+03	1.22E+03	1.10E+03	1.04E+03
Std Dev Un-Biased	4.63E+01	1.54E+02	2.19E+02	1.07E+02	2.57E+02	1.86E+02	7.94E+01
Ps90%/90% (+KTL) Un-Biased	1.17E+03	1.59E+03	1.73E+03	1.31E+03	1.92E+03	1.61E+03	1.26E+03
Ps90%/90% (-KTL) Un-Biased	9.13E+02	7.53E+02	5.26E+02	7.24E+02	5.11E+02	5.94E+02	8.20E+02
<b>Specification MIN</b>	<b>1.50E+02</b>	<b>1.50E+02</b>	<b>1.50E+02</b>	<b>1.50E+02</b>	<b>1.00E+02</b>	<b>1.00E+02</b>	<b>1.00E+02</b>
Status	PASS	PASS	PASS	PASS	PASS	PASS	PASS

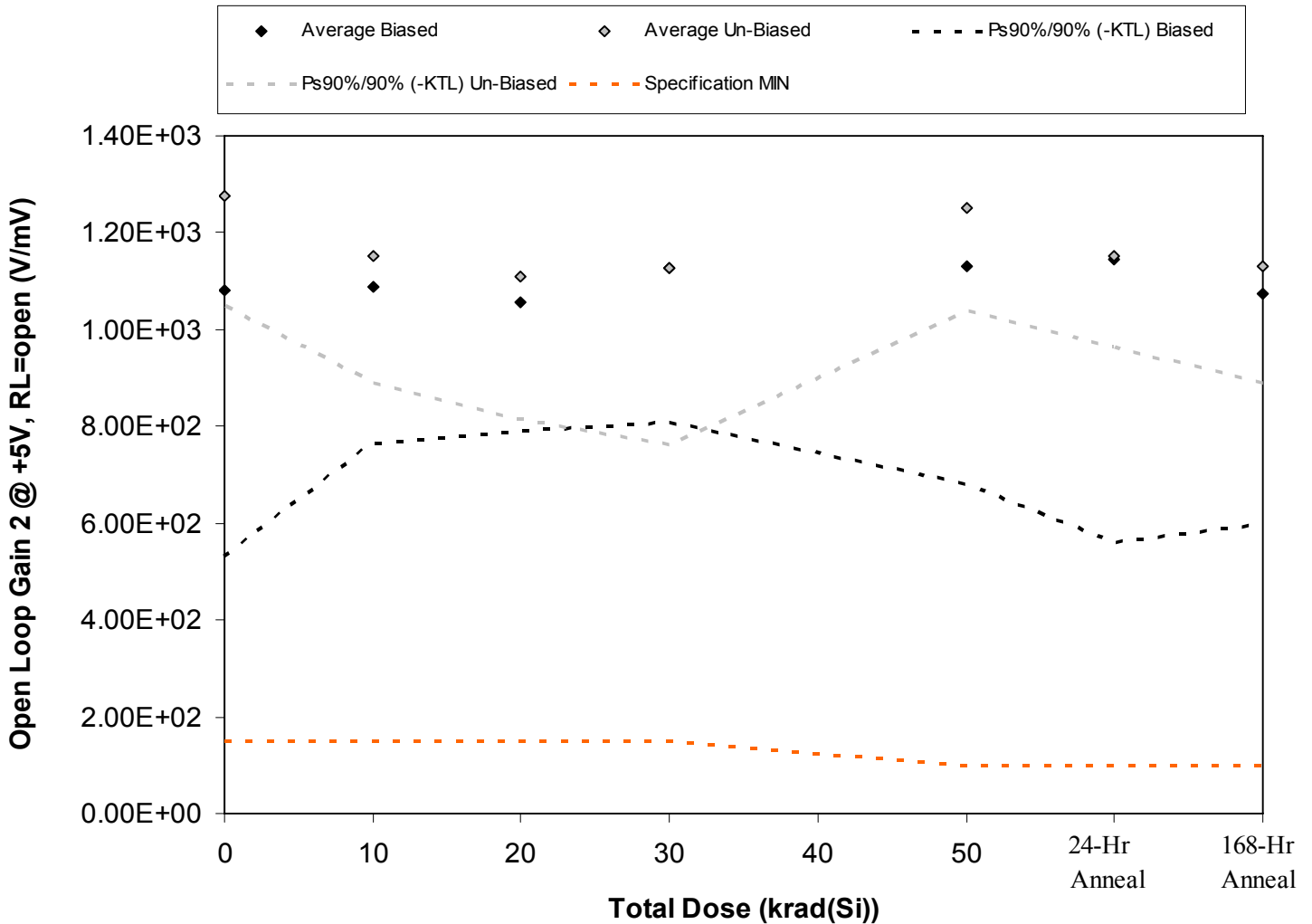

Figure 5.16. Plot of Open Loop Gain 2 @ +5V, RL=open (V/mV) versus total dose. The solid diamonds are the average of the measured data points for the samples irradiated under electrical bias while the shaded diamonds are the average of the measured data points for the samples irradiated with all pins tied to ground. The black lines (solid and/or dashed) are the average of the data points after application of the KTL statistics on the samples irradiated under electrical bias while the gray lines (solid and/or dashed) are the average of the data points after application of the KTL statistics on the samples irradiated in the unbiased condition. The red dotted line(s) are the pre- and/or post-irradiation minimum and/or maximum specification value as defined in the datasheet and/or test plan.



**TID Report  
10-004 100412 R1.0**

**Radiation Assured Devices  
5017 N. 30th Street  
Colorado Springs, CO 80919  
(719) 531-0800**

Table 5.16. Raw data for Open Loop Gain 2 @ +5V, RL=open (V/mV) versus total dose, including the statistical analysis, specification and the status of the testing (pass/fail).

Open Loop Gain 2 @ +5V, RL=open (V/mV)	Total Dose (krad(Si))					24 hr Anneal	168 hr Anneal
	0	10	20	30	50		
Device							
255	1.38E+03	1.27E+03	1.23E+03	1.32E+03	1.35E+03	1.43E+03	1.10E+03
258	9.56E+02	9.63E+02	1.01E+03	1.03E+03	9.61E+02	1.01E+03	1.07E+03
309	1.21E+03	1.02E+03	1.01E+03	1.08E+03	1.03E+03	9.82E+02	9.17E+02
359	9.15E+02	1.06E+03	1.05E+03	1.06E+03	1.24E+03	9.86E+02	9.39E+02
360	9.57E+02	1.12E+03	9.88E+02	1.14E+03	1.06E+03	1.33E+03	1.35E+03
416	1.33E+03	1.09E+03	1.08E+03	1.15E+03	1.32E+03	1.22E+03	1.06E+03
472	1.19E+03	1.23E+03	1.01E+03	9.98E+02	1.18E+03	1.13E+03	1.27E+03
473	1.27E+03	1.01E+03	1.02E+03	9.96E+02	1.31E+03	1.20E+03	1.08E+03
526	1.21E+03	1.19E+03	1.15E+03	1.31E+03	1.28E+03	1.04E+03	1.08E+03
529	1.38E+03	1.24E+03	1.27E+03	1.18E+03	1.15E+03	1.18E+03	1.16E+03
530	1.12E+03	1.01E+03	1.22E+03	9.57E+02	9.45E+02	9.21E+02	1.12E+03
561	1.22E+03	1.10E+03	1.12E+03	9.85E+02	1.04E+03	1.08E+03	9.81E+02
<b>Biased Statistics</b>							
Average Biased	1.08E+03	1.09E+03	1.06E+03	1.13E+03	1.13E+03	1.15E+03	1.08E+03
Std Dev Biased	2.01E+02	1.18E+02	9.71E+01	1.15E+02	1.64E+02	2.14E+02	1.74E+02
Ps90%/90% (+KTL) Biased	1.63E+03	1.41E+03	1.32E+03	1.44E+03	1.58E+03	1.73E+03	1.55E+03
Ps90%/90% (-KTL) Biased	5.30E+02	7.64E+02	7.91E+02	8.09E+02	6.81E+02	5.59E+02	5.99E+02
<b>Un-Biased Statistics</b>							
Average Un-Biased	1.28E+03	1.15E+03	1.11E+03	1.13E+03	1.25E+03	1.15E+03	1.13E+03
Std Dev Un-Biased	8.20E+01	9.65E+01	1.08E+02	1.33E+02	7.72E+01	6.93E+01	8.77E+01
Ps90%/90% (+KTL) Un-Biased	1.50E+03	1.42E+03	1.40E+03	1.49E+03	1.46E+03	1.34E+03	1.37E+03
Ps90%/90% (-KTL) Un-Biased	1.05E+03	8.88E+02	8.14E+02	7.64E+02	1.04E+03	9.63E+02	8.89E+02
<b>Specification MIN</b>	<b>1.50E+02</b>	<b>1.50E+02</b>	<b>1.50E+02</b>	<b>1.50E+02</b>	<b>1.00E+02</b>	<b>1.00E+02</b>	<b>1.00E+02</b>
Status	PASS	PASS	PASS	PASS	PASS	PASS	PASS

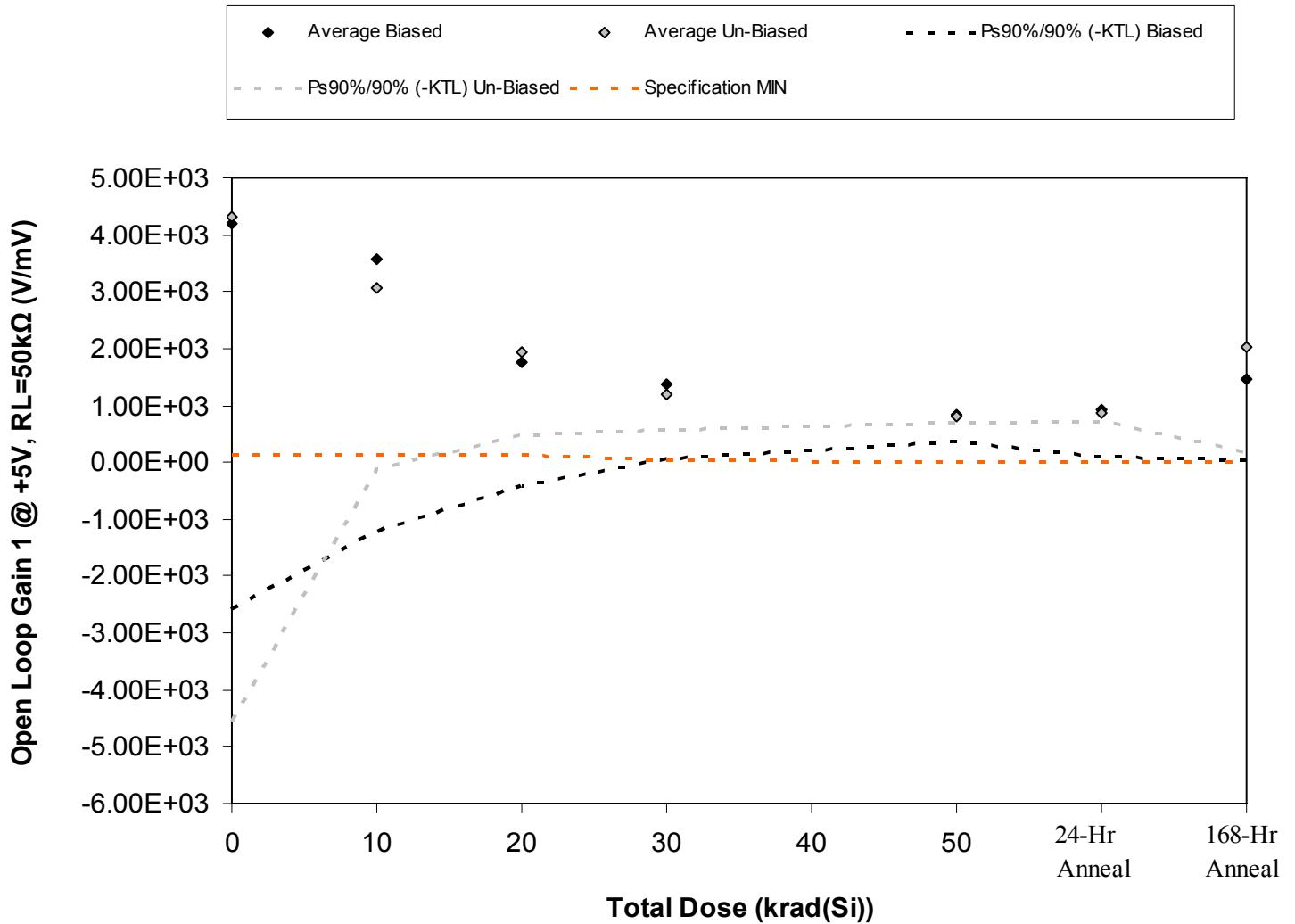

Figure 5.17. Plot of Open Loop Gain 1 @ +5V, RL=50kΩ (V/mV) versus total dose. The solid diamonds are the average of the measured data points for the samples irradiated under electrical bias while the shaded diamonds are the average of the measured data points for the samples irradiated with all pins tied to ground. The black lines (solid and/or dashed) are the average of the data points after application of the KTL statistics on the samples irradiated under electrical bias while the gray lines (solid and/or dashed) are the average of the data points after application of the KTL statistics on the samples irradiated in the unbiased condition. The red dotted line(s) are the pre- and/or post-irradiation minimum and/or maximum specification value as defined in the datasheet and/or test plan.





**TID Report**  
**10-004 100412 R1.0**

**Radiation Assured Devices**  
**5017 N. 30th Street**  
**Colorado Springs, CO 80919**  
**(719) 531-0800**

Table 5.17. Raw data for Open Loop Gain 1 @ +5V, RL=50kΩ (V/mV) versus total dose, including the statistical analysis, specification and the status of the testing (pass/fail).

Open Loop Gain 1 @ +5V, RL=50kΩ (V/mV)	Total Dose (krad(Si))					24 hr Anneal	168 hr Anneal
	0	10	20	30	50		
Device							
255	1.35E+03	2.03E+03	1.05E+03	9.14E+02	5.84E+02	5.83E+02	8.54E+02
258	3.82E+03	2.32E+03	1.29E+03	1.11E+03	8.23E+02	8.02E+02	1.43E+03
309	7.03E+03	6.11E+03	3.08E+03	2.17E+03	1.08E+03	1.40E+03	1.95E+03
359	6.38E+03	4.59E+03	1.83E+03	1.39E+03	8.77E+02	9.84E+02	1.99E+03
360	2.37E+03	2.76E+03	1.54E+03	1.30E+03	8.38E+02	8.08E+02	1.04E+03
416	3.63E+03	3.85E+03	1.44E+03	1.08E+03	8.13E+02	9.56E+02	1.94E+03
472	2.10E+03	1.90E+03	1.29E+03	1.08E+03	8.55E+02	8.21E+02	1.30E+03
473	3.19E+03	1.87E+03	2.35E+03	1.05E+03	7.89E+02	8.99E+02	2.38E+03
526	2.60E+03	3.22E+03	2.30E+03	1.59E+03	7.63E+02	8.78E+02	1.54E+03
529	1.00E+04	4.47E+03	2.33E+03	1.15E+03	7.74E+02	8.17E+02	2.97E+03
530	1.00E+04	4.27E+03	7.06E+03	9.36E+03	9.64E+03	1.00E+04	1.00E+04
561	2.59E+03	2.49E+03	2.35E+03	2.17E+03	3.08E+03	2.73E+03	2.00E+03
<b>Biased Statistics</b>							
Average Biased	4.19E+03	3.56E+03	1.76E+03	1.38E+03	8.40E+02	9.15E+02	1.45E+03
Std Dev Biased	2.47E+03	1.74E+03	7.93E+02	4.81E+02	1.76E+02	3.04E+02	5.16E+02
Ps90%/90% (+KTL) Biased	1.10E+04	8.33E+03	3.93E+03	2.70E+03	1.32E+03	1.75E+03	2.87E+03
Ps90%/90% (-KTL) Biased	-2.57E+03	-1.20E+03	-4.18E+02	6.18E+01	3.59E+02	7.99E+01	3.71E+01
<b>Un-Biased Statistics</b>							
Average Un-Biased	4.30E+03	3.06E+03	1.94E+03	1.19E+03	7.99E+02	8.74E+02	2.03E+03
Std Dev Un-Biased	3.24E+03	1.16E+03	5.29E+02	2.26E+02	3.68E+01	5.80E+01	6.70E+02
Ps90%/90% (+KTL) Un-Biased	1.32E+04	6.25E+03	3.39E+03	1.81E+03	8.99E+02	1.03E+03	3.86E+03
Ps90%/90% (-KTL) Un-Biased	-4.57E+03	-1.23E+02	4.92E+02	5.69E+02	6.98E+02	7.15E+02	1.90E+02
<b>Specification MIN</b>	<b>1.20E+02</b>	<b>1.20E+02</b>	<b>1.20E+02</b>	<b>5.00E+01</b>	<b>2.00E+01</b>	<b>2.00E+01</b>	<b>2.00E+01</b>
Status	PASS	PASS	PASS	PASS	PASS	PASS	PASS

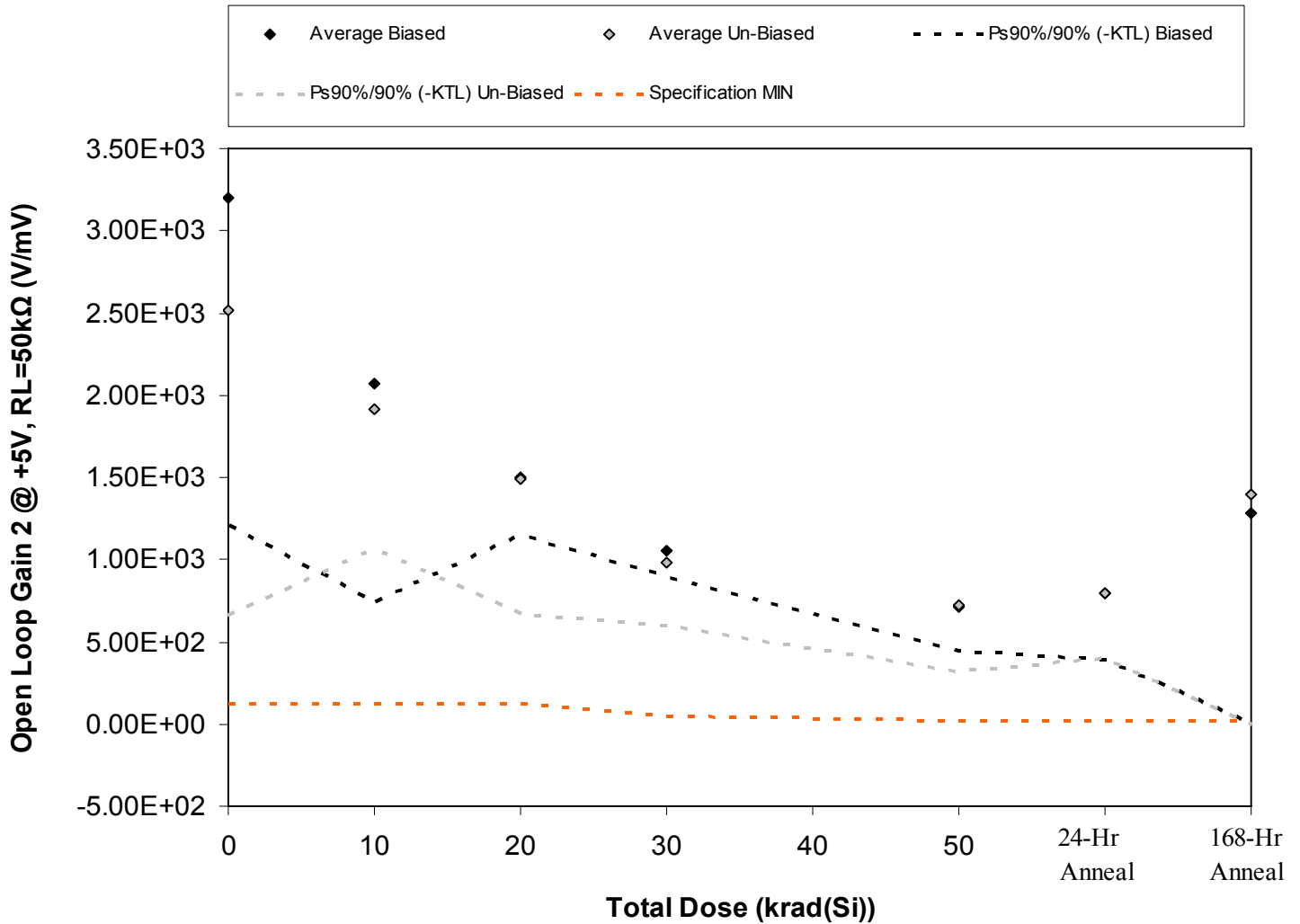

Figure 5.18. Plot of Open Loop Gain 2 @ +5V, RL=50kΩ (V/mV) versus total dose. The solid diamonds are the average of the measured data points for the samples irradiated under electrical bias while the shaded diamonds are the average of the measured data points for the samples irradiated with all pins tied to ground. The black lines (solid and/or dashed) are the average of the data points after application of the KTL statistics on the samples irradiated under electrical bias while the gray lines (solid and/or dashed) are the average of the data points after application of the KTL statistics on the samples irradiated in the unbiased condition. The red dotted line(s) are the pre- and/or post-irradiation minimum and/or maximum specification value as defined in the datasheet and/or test plan.



Table 5.18. Raw data for Open Loop Gain 2 @ +5V, RL=50kΩ (V/mV) versus total dose, including the statistical analysis, specification and the status of the testing (pass/fail).

Open Loop Gain 2 @ +5V, RL=50kΩ (V/mV)	Total Dose (krad(Si))					24 hr Anneal	168 hr Anneal
	0	10	20	30	50		
Device							
255	2.95E+03	1.72E+03	1.42E+03	9.68E+02	5.87E+02	6.33E+02	1.05E+03
258	3.23E+03	2.67E+03	1.51E+03	1.13E+03	7.06E+02	9.71E+02	2.00E+03
309	4.44E+03	2.51E+03	1.35E+03	1.09E+03	7.43E+02	7.80E+02	1.07E+03
359	2.78E+03	1.87E+03	1.69E+03	1.07E+03	8.52E+02	9.07E+02	1.47E+03
360	2.62E+03	1.60E+03	1.50E+03	1.04E+03	6.77E+02	6.75E+02	8.22E+02
416	1.91E+03	1.71E+03	1.44E+03	8.87E+02	7.02E+02	6.23E+02	9.78E+02
472	2.86E+03	2.36E+03	1.85E+03	1.17E+03	8.97E+02	9.98E+02	2.28E+03
473	1.68E+03	1.54E+03	1.37E+03	8.36E+02	5.64E+02	7.23E+02	1.16E+03
526	2.89E+03	1.98E+03	1.09E+03	9.37E+02	5.96E+02	7.79E+02	1.21E+03
529	3.24E+03	1.96E+03	1.70E+03	1.10E+03	8.34E+02	8.76E+02	1.38E+03
530	2.95E+03	3.37E+03	1.85E+03	2.09E+03	2.11E+03	2.19E+03	2.55E+03
561	2.78E+03	3.18E+03	3.21E+03	4.46E+03	5.07E+03	5.25E+03	3.03E+03
<b>Biased Statistics</b>							
Average Biased	3.20E+03	2.07E+03	1.50E+03	1.06E+03	7.13E+02	7.93E+02	1.28E+03
Std Dev Biased	7.28E+02	4.83E+02	1.27E+02	5.98E+01	9.69E+01	1.45E+02	4.64E+02
Ps90%/90% (+KTL) Biased	5.20E+03	3.40E+03	1.84E+03	1.22E+03	9.79E+02	1.19E+03	2.56E+03
Ps90%/90% (-KTL) Biased	1.21E+03	7.48E+02	1.15E+03	8.95E+02	4.47E+02	3.95E+02	1.15E+01
<b>Un-Biased Statistics</b>							
Average Un-Biased	2.52E+03	1.91E+03	1.49E+03	9.86E+02	7.19E+02	8.00E+02	1.40E+03
Std Dev Un-Biased	6.77E+02	3.10E+02	2.97E+02	1.42E+02	1.45E+02	1.44E+02	5.11E+02
Ps90%/90% (+KTL) Un-Biased	4.37E+03	2.76E+03	2.30E+03	1.38E+03	1.12E+03	1.19E+03	2.80E+03
Ps90%/90% (-KTL) Un-Biased	6.60E+02	1.06E+03	6.76E+02	5.96E+02	3.20E+02	4.06E+02	#####
<b>Specification MIN</b>	<b>1.20E+02</b>	<b>1.20E+02</b>	<b>1.20E+02</b>	<b>5.00E+01</b>	<b>2.00E+01</b>	<b>2.00E+01</b>	<b>2.00E+01</b>
Status	PASS	PASS	PASS	PASS	PASS	PASS	PASS

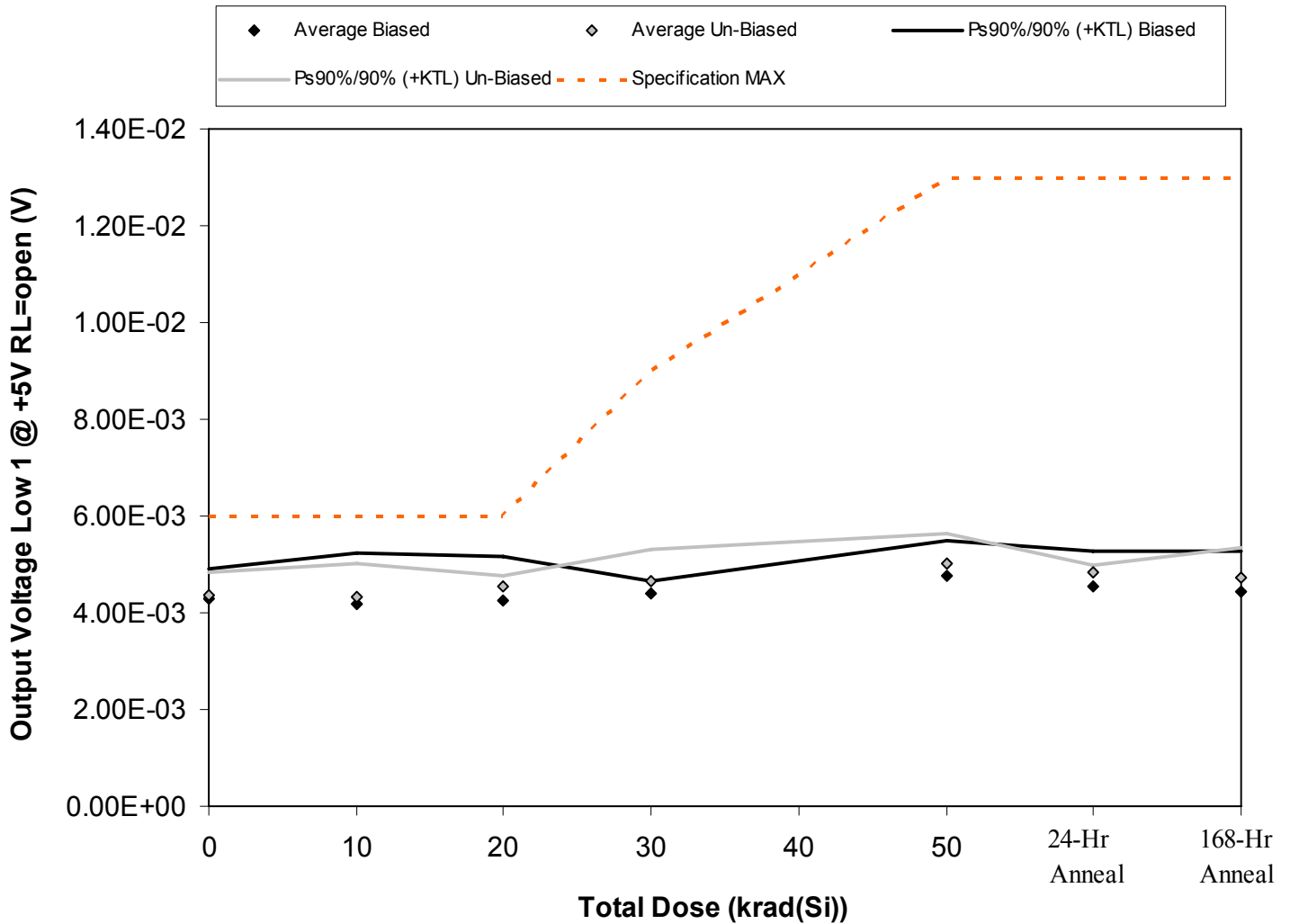

Figure 5.19. Plot of Output Voltage Low 1 @ +5V RL=open (V) versus total dose. The solid diamonds are the average of the measured data points for the samples irradiated under electrical bias while the shaded diamonds are the average of the measured data points for the samples irradiated with all pins tied to ground. The black lines (solid and/or dashed) are the average of the data points after application of the KTL statistics on the samples irradiated under electrical bias while the gray lines (solid and/or dashed) are the average of the data points after application of the KTL statistics on the samples irradiated in the unbiased condition. The red dotted line(s) are the pre- and/or post-irradiation minimum and/or maximum specification value as defined in the datasheet and/or test plan.



Table 5.19. Raw data for Output Voltage Low 1 @ +5V RL=open (V) versus total dose, including the statistical analysis, specification and the status of the testing (pass/fail).

Output Voltage Low 1 @ +5V RL=open (V)	Total Dose (krad(Si))					24 hr Anneal	168 hr Anneal
	0	10	20	30	50		
Device							
255	4.61E-03	4.45E-03	4.33E-03	4.24E-03	4.85E-03	4.85E-03	4.46E-03
258	4.18E-03	3.76E-03	3.81E-03	4.38E-03	4.60E-03	4.21E-03	4.40E-03
309	4.40E-03	4.38E-03	4.24E-03	4.50E-03	4.99E-03	4.55E-03	4.43E-03
359	4.13E-03	3.81E-03	4.18E-03	4.36E-03	4.95E-03	4.36E-03	4.90E-03
360	4.06E-03	4.56E-03	4.73E-03	4.45E-03	4.36E-03	4.77E-03	4.08E-03
416	4.60E-03	3.96E-03	4.45E-03	4.24E-03	4.97E-03	4.78E-03	4.82E-03
472	4.21E-03	4.53E-03	4.46E-03	4.72E-03	5.04E-03	4.82E-03	4.78E-03
473	4.35E-03	4.14E-03	4.58E-03	4.85E-03	5.36E-03	4.82E-03	4.97E-03
526	4.23E-03	4.46E-03	4.65E-03	4.75E-03	4.97E-03	4.92E-03	4.66E-03
529	4.50E-03	4.48E-03	4.53E-03	4.73E-03	4.72E-03	4.83E-03	4.34E-03
530	4.04E-03	4.46E-03	4.40E-03	4.90E-03	3.99E-03	4.51E-03	4.60E-03
561	4.29E-03	3.97E-03	4.34E-03	4.24E-03	4.29E-03	3.84E-03	4.11E-03
<b>Biased Statistics</b>							
Average Biased	4.28E-03	4.19E-03	4.26E-03	4.39E-03	4.75E-03	4.55E-03	4.45E-03
Std Dev Biased	2.26E-04	3.77E-04	3.30E-04	9.89E-05	2.66E-04	2.69E-04	2.93E-04
Ps90%/90% (+KTL) Biased	4.90E-03	5.23E-03	5.16E-03	4.66E-03	5.48E-03	5.29E-03	5.26E-03
Ps90%/90% (-KTL) Biased	3.66E-03	3.16E-03	3.35E-03	4.11E-03	4.02E-03	3.81E-03	3.65E-03
<b>Un-Biased Statistics</b>							
Average Un-Biased	4.38E-03	4.31E-03	4.53E-03	4.66E-03	5.01E-03	4.83E-03	4.71E-03
Std Dev Un-Biased	1.70E-04	2.51E-04	8.38E-05	2.39E-04	2.29E-04	5.18E-05	2.37E-04
Ps90%/90% (+KTL) Un-Biased	4.84E-03	5.00E-03	4.76E-03	5.31E-03	5.64E-03	4.98E-03	5.36E-03
Ps90%/90% (-KTL) Un-Biased	3.91E-03	3.63E-03	4.30E-03	4.00E-03	4.38E-03	4.69E-03	4.07E-03
<b>Specification MAX</b>	<b>6.00E-03</b>	<b>6.00E-03</b>	<b>6.00E-03</b>	<b>9.00E-03</b>	<b>1.30E-02</b>	<b>1.30E-02</b>	<b>1.30E-02</b>
Status	PASS	PASS	PASS	PASS	PASS	PASS	PASS

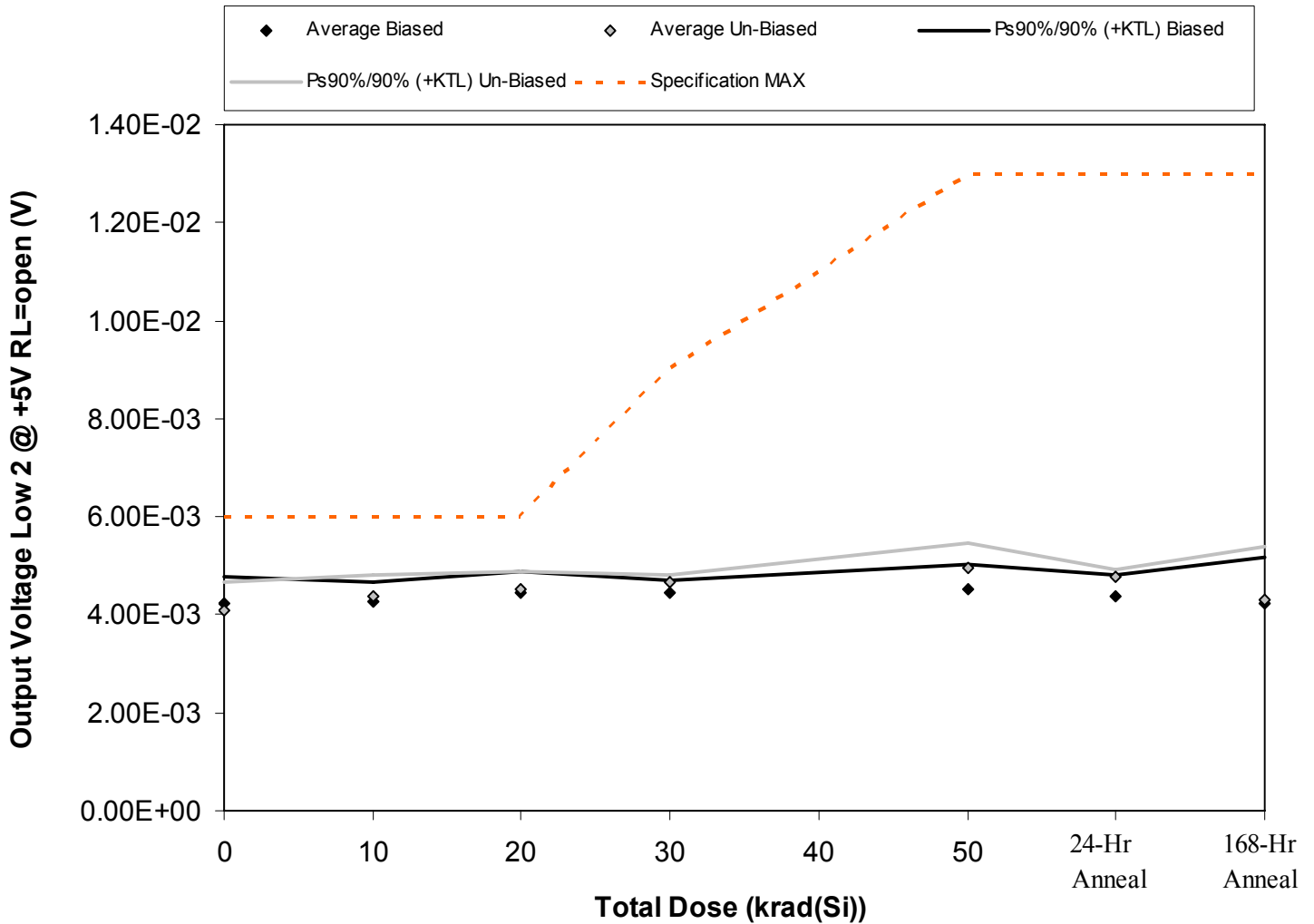

Figure 5.20. Plot of Output Voltage Low 2 @ +5V RL=open (V) versus total dose. The solid diamonds are the average of the measured data points for the samples irradiated under electrical bias while the shaded diamonds are the average of the measured data points for the samples irradiated with all pins tied to ground. The black lines (solid and/or dashed) are the average of the data points after application of the KTL statistics on the samples irradiated under electrical bias while the gray lines (solid and/or dashed) are the average of the data points after application of the KTL statistics on the samples irradiated in the unbiased condition. The red dotted line(s) are the pre- and/or post-irradiation minimum and/or maximum specification value as defined in the datasheet and/or test plan.



Table 5.20. Raw data for Output Voltage Low 2 @ +5V RL=open (V) versus total dose, including the statistical analysis, specification and the status of the testing (pass/fail).

Output Voltage Low 2 @ +5V RL=open (V)	Total Dose (krad(Si))					24 hr Anneal	168 hr Anneal
	0	10	20	30	50		
Device							
255	4.24E-03	4.38E-03	4.23E-03	4.36E-03	4.45E-03	4.18E-03	4.46E-03
258	4.43E-03	4.26E-03	4.41E-03	4.55E-03	4.50E-03	4.51E-03	4.55E-03
309	4.45E-03	4.43E-03	4.66E-03	4.33E-03	4.43E-03	4.51E-03	3.84E-03
359	3.99E-03	4.21E-03	4.45E-03	4.43E-03	4.85E-03	4.24E-03	3.92E-03
360	4.14E-03	4.04E-03	4.53E-03	4.53E-03	4.40E-03	4.46E-03	4.48E-03
416	3.99E-03	4.39E-03	4.53E-03	4.72E-03	5.07E-03	4.80E-03	3.86E-03
472	4.01E-03	4.19E-03	4.55E-03	4.61E-03	5.05E-03	4.70E-03	3.87E-03
473	4.46E-03	4.33E-03	4.71E-03	4.72E-03	4.73E-03	4.80E-03	4.43E-03
526	4.04E-03	4.41E-03	4.38E-03	4.63E-03	5.15E-03	4.73E-03	4.68E-03
529	3.97E-03	4.61E-03	4.43E-03	4.65E-03	4.85E-03	4.82E-03	4.63E-03
530	4.16E-03	4.13E-03	4.09E-03	4.11E-03	4.65E-03	4.35E-03	4.09E-03
561	3.65E-03	4.28E-03	4.31E-03	4.56E-03	4.46E-03	4.19E-03	4.01E-03
<b>Biased Statistics</b>							
Average Biased	4.25E-03	4.26E-03	4.46E-03	4.44E-03	4.53E-03	4.38E-03	4.25E-03
Std Dev Biased	1.95E-04	1.53E-04	1.58E-04	9.85E-05	1.85E-04	1.58E-04	3.41E-04
Ps90%/90% (+KTL) Biased	4.78E-03	4.68E-03	4.89E-03	4.71E-03	5.03E-03	4.81E-03	5.18E-03
Ps90%/90% (-KTL) Biased	3.72E-03	3.84E-03	4.02E-03	4.17E-03	4.02E-03	3.95E-03	3.32E-03
<b>Un-Biased Statistics</b>							
Average Un-Biased	4.09E-03	4.39E-03	4.52E-03	4.67E-03	4.97E-03	4.77E-03	4.29E-03
Std Dev Un-Biased	2.06E-04	1.52E-04	1.27E-04	5.13E-05	1.74E-04	5.20E-05	4.03E-04
Ps90%/90% (+KTL) Un-Biased	4.66E-03	4.80E-03	4.87E-03	4.81E-03	5.45E-03	4.91E-03	5.40E-03
Ps90%/90% (-KTL) Un-Biased	3.53E-03	3.97E-03	4.17E-03	4.53E-03	4.49E-03	4.63E-03	3.19E-03
<b>Specification MAX</b>	<b>6.00E-03</b>	<b>6.00E-03</b>	<b>6.00E-03</b>	<b>9.00E-03</b>	<b>1.30E-02</b>	<b>1.30E-02</b>	<b>1.30E-02</b>
Status	PASS	PASS	PASS	PASS	PASS	PASS	PASS

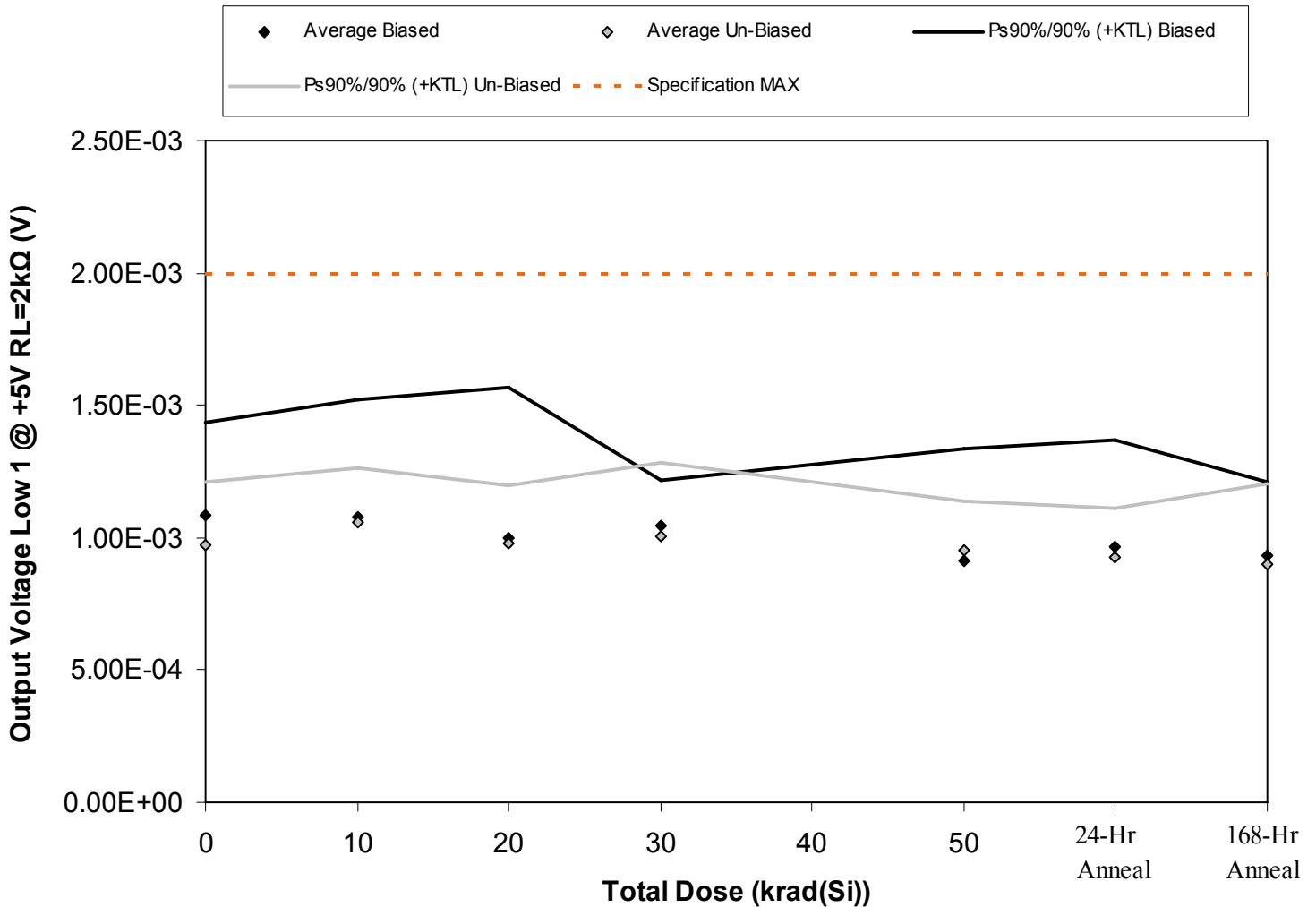

Figure 5.21. Plot of Output Voltage Low 1 @ +5V RL=2kΩ (V) versus total dose. The solid diamonds are the average of the measured data points for the samples irradiated under electrical bias while the shaded diamonds are the average of the measured data points for the samples irradiated with all pins tied to ground. The black lines (solid and/or dashed) are the average of the data points after application of the KTL statistics on the samples irradiated under electrical bias while the gray lines (solid and/or dashed) are the average of the data points after application of the KTL statistics on the samples irradiated in the unbiased condition. The red dotted line(s) are the pre- and/or post-irradiation minimum and/or maximum specification value as defined in the datasheet and/or test plan.





Table 5.21. Raw data for Output Voltage Low 1 @ +5V RL=2kΩ (V) versus total dose, including the statistical analysis, specification and the status of the testing (pass/fail).

Output Voltage Low 1 @ +5V RL=2kΩ (V)	Total Dose (krad(Si))					24 hr Anneal	168 hr Anneal
	0	10	20	30	50		
Device							
255	9.40E-04	8.30E-04	7.80E-04	9.60E-04	7.30E-04	7.10E-04	8.80E-04
258	1.25E-03	1.13E-03	1.31E-03	1.10E-03	1.15E-03	1.07E-03	8.30E-04
309	1.00E-03	1.18E-03	1.09E-03	1.08E-03	8.80E-04	9.90E-04	1.01E-03
359	1.18E-03	1.24E-03	9.20E-04	1.09E-03	8.70E-04	1.06E-03	1.07E-03
360	1.04E-03	1.02E-03	8.90E-04	9.90E-04	9.40E-04	9.90E-04	8.80E-04
416	9.10E-04	1.08E-03	9.90E-04	1.01E-03	9.80E-04	9.40E-04	9.00E-04
472	9.80E-04	9.90E-04	8.70E-04	1.14E-03	9.50E-04	8.60E-04	1.03E-03
473	9.20E-04	1.09E-03	1.05E-03	8.80E-04	1.05E-03	8.60E-04	7.40E-04
526	1.12E-03	1.16E-03	1.05E-03	9.50E-04	8.70E-04	1.01E-03	9.70E-04
529	9.40E-04	9.80E-04	9.20E-04	1.06E-03	9.20E-04	9.70E-04	8.50E-04
530	1.05E-03	1.03E-03	1.19E-03	8.80E-04	1.01E-03	1.00E-03	1.09E-03
561	1.12E-03	1.10E-03	9.10E-04	1.06E-03	1.09E-03	1.13E-03	1.17E-03
<b>Biased Statistics</b>							
Average Biased	1.08E-03	1.08E-03	9.98E-04	1.04E-03	9.14E-04	9.64E-04	9.34E-04
Std Dev Biased	1.29E-04	1.61E-04	2.07E-04	6.43E-05	1.53E-04	1.47E-04	1.01E-04
Ps90%/90% (+KTL) Biased	1.44E-03	1.52E-03	1.57E-03	1.22E-03	1.33E-03	1.37E-03	1.21E-03
Ps90%/90% (-KTL) Biased	7.29E-04	6.37E-04	4.31E-04	8.68E-04	4.95E-04	5.61E-04	6.57E-04
<b>Un-Biased Statistics</b>							
Average Un-Biased	9.74E-04	1.06E-03	9.76E-04	1.01E-03	9.54E-04	9.28E-04	8.98E-04
Std Dev Un-Biased	8.59E-05	7.52E-05	7.99E-05	9.98E-05	6.73E-05	6.69E-05	1.12E-04
Ps90%/90% (+KTL) Un-Biased	1.21E-03	1.27E-03	1.20E-03	1.28E-03	1.14E-03	1.11E-03	1.20E-03
Ps90%/90% (-KTL) Un-Biased	7.38E-04	8.54E-04	7.57E-04	7.34E-04	7.69E-04	7.45E-04	5.92E-04
<b>Specification MAX</b>	<b>2.00E-03</b>	<b>2.00E-03</b>	<b>2.00E-03</b>	<b>2.00E-03</b>	<b>2.00E-03</b>	<b>2.00E-03</b>	<b>2.00E-03</b>
Status	PASS	PASS	PASS	PASS	PASS	PASS	PASS

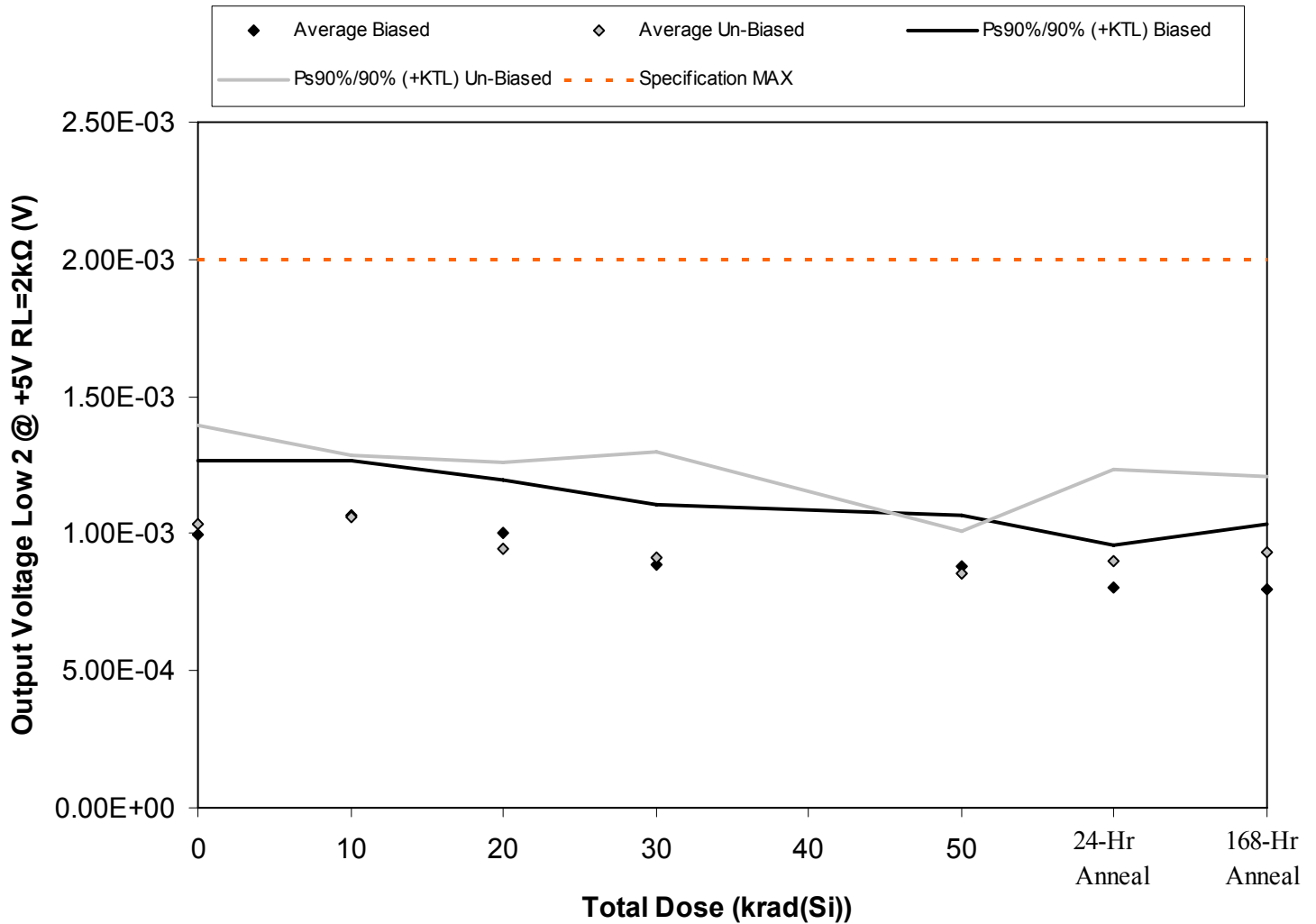

Figure 5.22. Plot of Output Voltage Low 2 @ +5V RL=2kΩ (V) versus total dose. The solid diamonds are the average of the measured data points for the samples irradiated under electrical bias while the shaded diamonds are the average of the measured data points for the samples irradiated with all pins tied to ground. The black lines (solid and/or dashed) are the average of the data points after application of the KTL statistics on the samples irradiated under electrical bias while the gray lines (solid and/or dashed) are the average of the data points after application of the KTL statistics on the samples irradiated in the unbiased condition. The red dotted line(s) are the pre- and/or post-irradiation minimum and/or maximum specification value as defined in the datasheet and/or test plan.



Table 5.22. Raw data for Output Voltage Low 2 @ +5V RL=2kΩ (V) versus total dose, including the statistical analysis, specification and the status of the testing (pass/fail).

Output Voltage Low 2 @ +5V RL=2kΩ (V)	Total Dose (krad(Si))					24 hr Anneal	168 hr Anneal
	0	10	20	30	50		
Device							
255	1.11E-03	1.15E-03	1.11E-03	9.70E-04	7.80E-04	8.40E-04	7.30E-04
258	8.40E-04	1.11E-03	9.80E-04	9.30E-04	8.40E-04	7.80E-04	9.50E-04
309	9.90E-04	1.10E-03	9.10E-04	8.00E-04	9.20E-04	8.80E-04	7.60E-04
359	1.00E-03	1.00E-03	1.00E-03	8.00E-04	9.50E-04	7.60E-04	7.90E-04
360	1.03E-03	9.90E-04	1.00E-03	9.30E-04	9.00E-04	7.50E-04	7.70E-04
416	8.30E-04	1.04E-03	8.30E-04	7.00E-04	8.20E-04	7.30E-04	8.20E-04
472	1.14E-03	1.13E-03	1.01E-03	9.60E-04	8.80E-04	1.02E-03	8.40E-04
473	9.90E-04	9.80E-04	1.03E-03	1.02E-03	8.00E-04	9.70E-04	1.03E-03
526	1.15E-03	9.90E-04	8.00E-04	1.04E-03	9.40E-04	9.60E-04	1.03E-03
529	1.07E-03	1.16E-03	1.04E-03	8.40E-04	8.40E-04	8.10E-04	9.40E-04
530	1.06E-03	1.08E-03	9.90E-04	1.11E-03	8.60E-04	1.12E-03	8.30E-04
561	1.06E-03	1.13E-03	1.14E-03	9.80E-04	7.20E-04	1.05E-03	9.30E-04
<b>Biased Statistics</b>							
Average Biased	9.94E-04	1.07E-03	1.00E-03	8.86E-04	8.78E-04	8.02E-04	8.00E-04
Std Dev Biased	9.81E-05	7.11E-05	7.18E-05	8.02E-05	6.80E-05	5.59E-05	8.66E-05
Ps90%/90% (+KTL) Biased	1.26E-03	1.26E-03	1.20E-03	1.11E-03	1.06E-03	9.55E-04	1.04E-03
Ps90%/90% (-KTL) Biased	7.25E-04	8.75E-04	8.03E-04	6.66E-04	6.92E-04	6.49E-04	5.63E-04
<b>Un-Biased Statistics</b>							
Average Un-Biased	1.04E-03	1.06E-03	9.42E-04	9.12E-04	8.56E-04	8.98E-04	9.32E-04
Std Dev Un-Biased	1.32E-04	8.15E-05	1.17E-04	1.42E-04	5.55E-05	1.22E-04	1.00E-04
Ps90%/90% (+KTL) Un-Biased	1.40E-03	1.28E-03	1.26E-03	1.30E-03	1.01E-03	1.23E-03	1.21E-03
Ps90%/90% (-KTL) Un-Biased	6.75E-04	8.36E-04	6.21E-04	5.23E-04	7.04E-04	5.63E-04	6.57E-04
<b>Specification MAX</b>	<b>2.00E-03</b>	<b>2.00E-03</b>	<b>2.00E-03</b>	<b>2.00E-03</b>	<b>2.00E-03</b>	<b>2.00E-03</b>	<b>2.00E-03</b>
Status	PASS	PASS	PASS	PASS	PASS	PASS	PASS

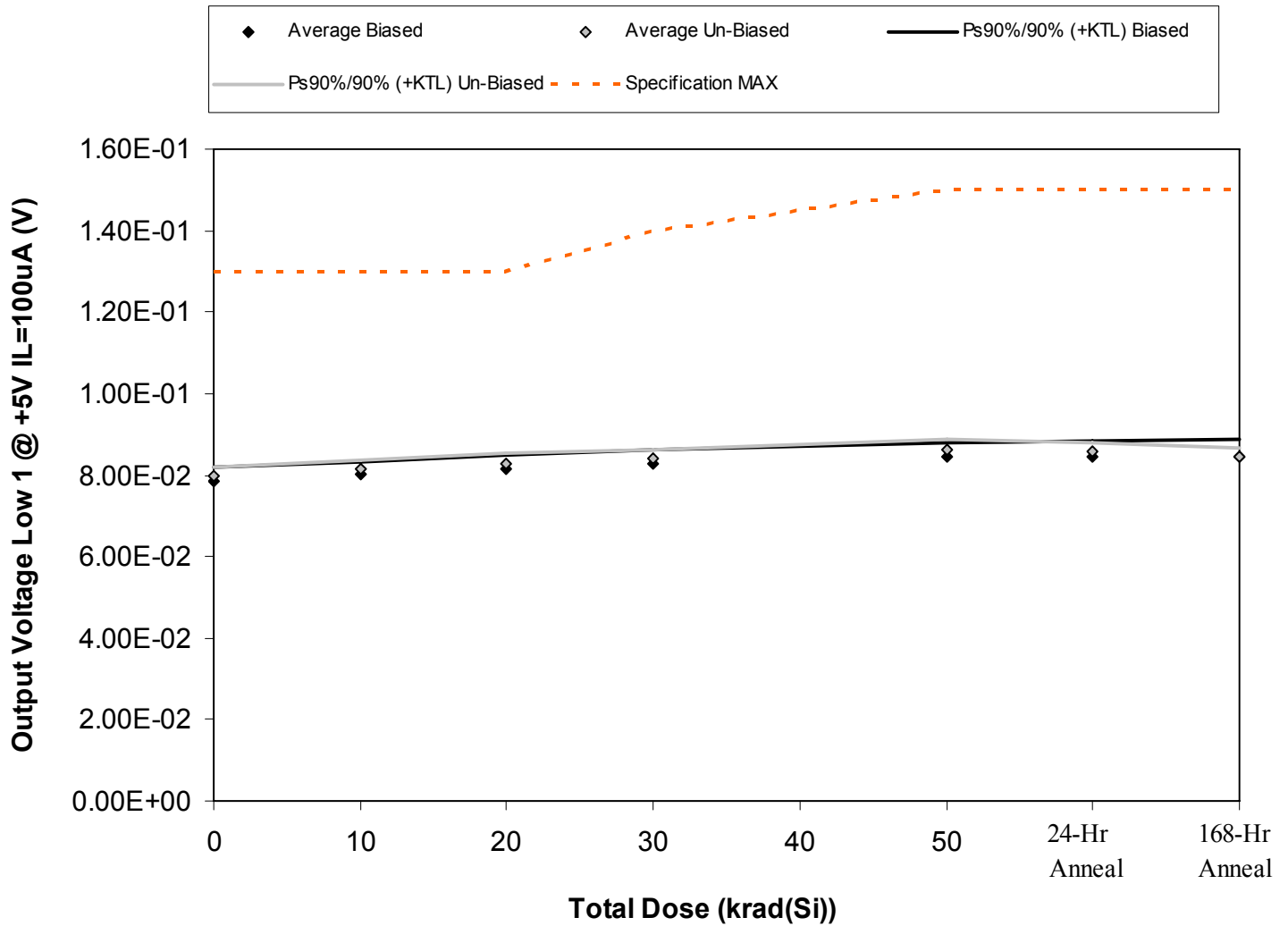

Figure 5.23. Plot of Output Voltage Low 1 @ +5V IL=100uA (V) versus total dose. The solid diamonds are the average of the measured data points for the samples irradiated under electrical bias while the shaded diamonds are the average of the measured data points for the samples irradiated with all pins tied to ground. The black lines (solid and/or dashed) are the average of the data points after application of the KTL statistics on the samples irradiated under electrical bias while the gray lines (solid and/or dashed) are the average of the data points after application of the KTL statistics on the samples irradiated in the unbiased condition. The red dotted line(s) are the pre- and/or post-irradiation minimum and/or maximum specification value as defined in the datasheet and/or test plan.



Table 5.23. Raw data for Output Voltage Low 1 @ +5V IL=100uA (V) versus total dose, including the statistical analysis, specification and the status of the testing (pass/fail).

Output Voltage Low 1 @ +5V IL=100uA (V)	Total Dose (krad(Si))					24 hr Anneal	168 hr Anneal
	0	10	20	30	50		
Device							
255	8.03E-02	8.16E-02	8.34E-02	8.46E-02	8.64E-02	8.67E-02	8.72E-02
258	7.69E-02	7.88E-02	8.03E-02	8.10E-02	8.29E-02	8.31E-02	8.30E-02
309	7.83E-02	7.95E-02	8.05E-02	8.22E-02	8.43E-02	8.39E-02	8.35E-02
359	7.88E-02	8.08E-02	8.16E-02	8.28E-02	8.44E-02	8.48E-02	8.47E-02
360	7.90E-02	8.08E-02	8.16E-02	8.25E-02	8.49E-02	8.49E-02	8.45E-02
416	8.05E-02	8.22E-02	8.43E-02	8.49E-02	8.69E-02	8.65E-02	8.53E-02
472	7.86E-02	8.04E-02	8.19E-02	8.27E-02	8.48E-02	8.43E-02	8.31E-02
473	8.02E-02	8.22E-02	8.35E-02	8.46E-02	8.73E-02	8.64E-02	8.48E-02
526	7.97E-02	8.13E-02	8.25E-02	8.37E-02	8.65E-02	8.53E-02	8.42E-02
529	7.92E-02	8.08E-02	8.23E-02	8.35E-02	8.57E-02	8.56E-02	8.40E-02
530	8.00E-02	8.03E-02	8.07E-02	8.08E-02	8.11E-02	8.03E-02	8.05E-02
561	7.91E-02	7.99E-02	7.97E-02	7.97E-02	7.98E-02	7.97E-02	8.02E-02
<b>Biased Statistics</b>							
Average Biased	7.87E-02	8.03E-02	8.15E-02	8.26E-02	8.46E-02	8.47E-02	8.46E-02
Std Dev Biased	1.21E-03	1.10E-03	1.27E-03	1.29E-03	1.29E-03	1.35E-03	1.61E-03
Ps90%/90% (+KTL) Biased	8.20E-02	8.33E-02	8.49E-02	8.61E-02	8.81E-02	8.84E-02	8.90E-02
Ps90%/90% (-KTL) Biased	7.53E-02	7.73E-02	7.80E-02	7.91E-02	8.11E-02	8.10E-02	8.02E-02
<b>Un-Biased Statistics</b>							
Average Un-Biased	7.96E-02	8.14E-02	8.29E-02	8.39E-02	8.62E-02	8.56E-02	8.43E-02
Std Dev Un-Biased	7.69E-04	8.13E-04	9.53E-04	9.01E-04	1.00E-03	8.97E-04	8.34E-04
Ps90%/90% (+KTL) Un-Biased	8.17E-02	8.36E-02	8.55E-02	8.63E-02	8.90E-02	8.81E-02	8.66E-02
Ps90%/90% (-KTL) Un-Biased	7.75E-02	7.91E-02	8.03E-02	8.14E-02	8.35E-02	8.31E-02	8.20E-02
<b>Specification MAX</b>	<b>1.30E-01</b>	<b>1.30E-01</b>	<b>1.30E-01</b>	<b>1.40E-01</b>	<b>1.50E-01</b>	<b>1.50E-01</b>	<b>1.50E-01</b>
Status	PASS	PASS	PASS	PASS	PASS	PASS	PASS

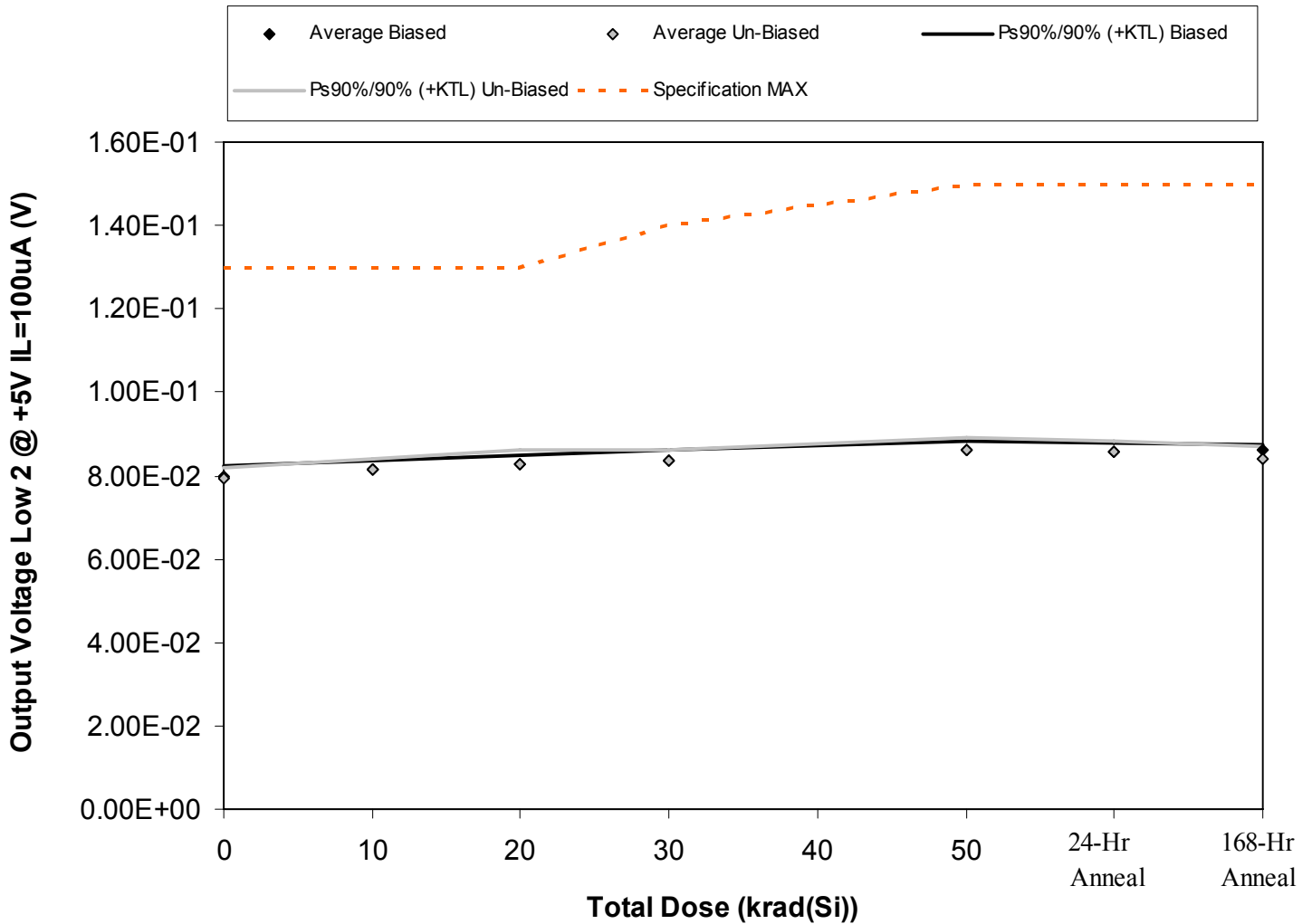

Figure 5.24. Plot of Output Voltage Low 2 @ +5V IL=100uA (V) versus total dose. The solid diamonds are the average of the measured data points for the samples irradiated under electrical bias while the shaded diamonds are the average of the measured data points for the samples irradiated with all pins tied to ground. The black lines (solid and/or dashed) are the average of the data points after application of the KTL statistics on the samples irradiated under electrical bias while the gray lines (solid and/or dashed) are the average of the data points after application of the KTL statistics on the samples irradiated in the unbiased condition. The red dotted line(s) are the pre- and/or post-irradiation minimum and/or maximum specification value as defined in the datasheet and/or test plan.



**TID Report  
10-004 100412 R1.0**

**Radiation Assured Devices  
5017 N. 30th Street  
Colorado Springs, CO 80919  
(719) 531-0800**

Table 5.24. Raw data for Output Voltage Low 2 @ +5V IL=100uA (V) versus total dose, including the statistical analysis, specification and the status of the testing (pass/fail).

Output Voltage Low 2 @ +5V IL=100uA (V)	Total Dose (krad(Si))					24 hr Anneal	168 hr Anneal
	0	10	20	30	50		
Device							
255	7.89E-02	8.03E-02	8.17E-02	8.27E-02	8.50E-02	8.51E-02	8.55E-02
258	8.08E-02	8.22E-02	8.33E-02	8.42E-02	8.67E-02	8.66E-02	8.68E-02
309	7.90E-02	8.11E-02	8.19E-02	8.33E-02	8.59E-02	8.51E-02	8.58E-02
359	8.08E-02	8.21E-02	8.34E-02	8.51E-02	8.69E-02	8.66E-02	8.60E-02
360	8.03E-02	8.14E-02	8.27E-02	8.38E-02	8.63E-02	8.57E-02	8.63E-02
416	8.08E-02	8.29E-02	8.45E-02	8.50E-02	8.75E-02	8.71E-02	8.57E-02
472	7.97E-02	8.13E-02	8.24E-02	8.36E-02	8.60E-02	8.54E-02	8.42E-02
473	7.93E-02	8.13E-02	8.27E-02	8.43E-02	8.64E-02	8.53E-02	8.40E-02
526	7.83E-02	8.01E-02	8.10E-02	8.26E-02	8.47E-02	8.43E-02	8.31E-02
529	7.92E-02	8.14E-02	8.22E-02	8.35E-02	8.63E-02	8.57E-02	8.39E-02
530	7.96E-02	7.99E-02	8.03E-02	8.04E-02	7.96E-02	7.99E-02	8.01E-02
561	7.92E-02	8.00E-02	8.00E-02	7.96E-02	8.01E-02	8.00E-02	8.01E-02
<b>Biased Statistics</b>							
Average Biased	7.99E-02	8.14E-02	8.26E-02	8.38E-02	8.62E-02	8.58E-02	8.61E-02
Std Dev Biased	9.26E-04	7.69E-04	7.77E-04	9.32E-04	7.46E-04	7.74E-04	4.96E-04
Ps90%/90% (+KTL) Biased	8.25E-02	8.35E-02	8.47E-02	8.64E-02	8.82E-02	8.79E-02	8.75E-02
Ps90%/90% (-KTL) Biased	7.74E-02	7.93E-02	8.05E-02	8.13E-02	8.41E-02	8.37E-02	8.47E-02
<b>Un-Biased Statistics</b>							
Average Un-Biased	7.94E-02	8.14E-02	8.26E-02	8.38E-02	8.62E-02	8.56E-02	8.42E-02
Std Dev Un-Biased	8.93E-04	1.02E-03	1.29E-03	9.12E-04	1.00E-03	1.02E-03	9.51E-04
Ps90%/90% (+KTL) Un-Biased	8.19E-02	8.42E-02	8.61E-02	8.63E-02	8.89E-02	8.84E-02	8.68E-02
Ps90%/90% (-KTL) Un-Biased	7.70E-02	7.86E-02	7.90E-02	8.13E-02	8.34E-02	8.28E-02	8.16E-02
<b>Specification MAX</b>	<b>1.30E-01</b>	<b>1.30E-01</b>	<b>1.30E-01</b>	<b>1.40E-01</b>	<b>1.50E-01</b>	<b>1.50E-01</b>	<b>1.50E-01</b>
Status	PASS	PASS	PASS	PASS	PASS	PASS	PASS

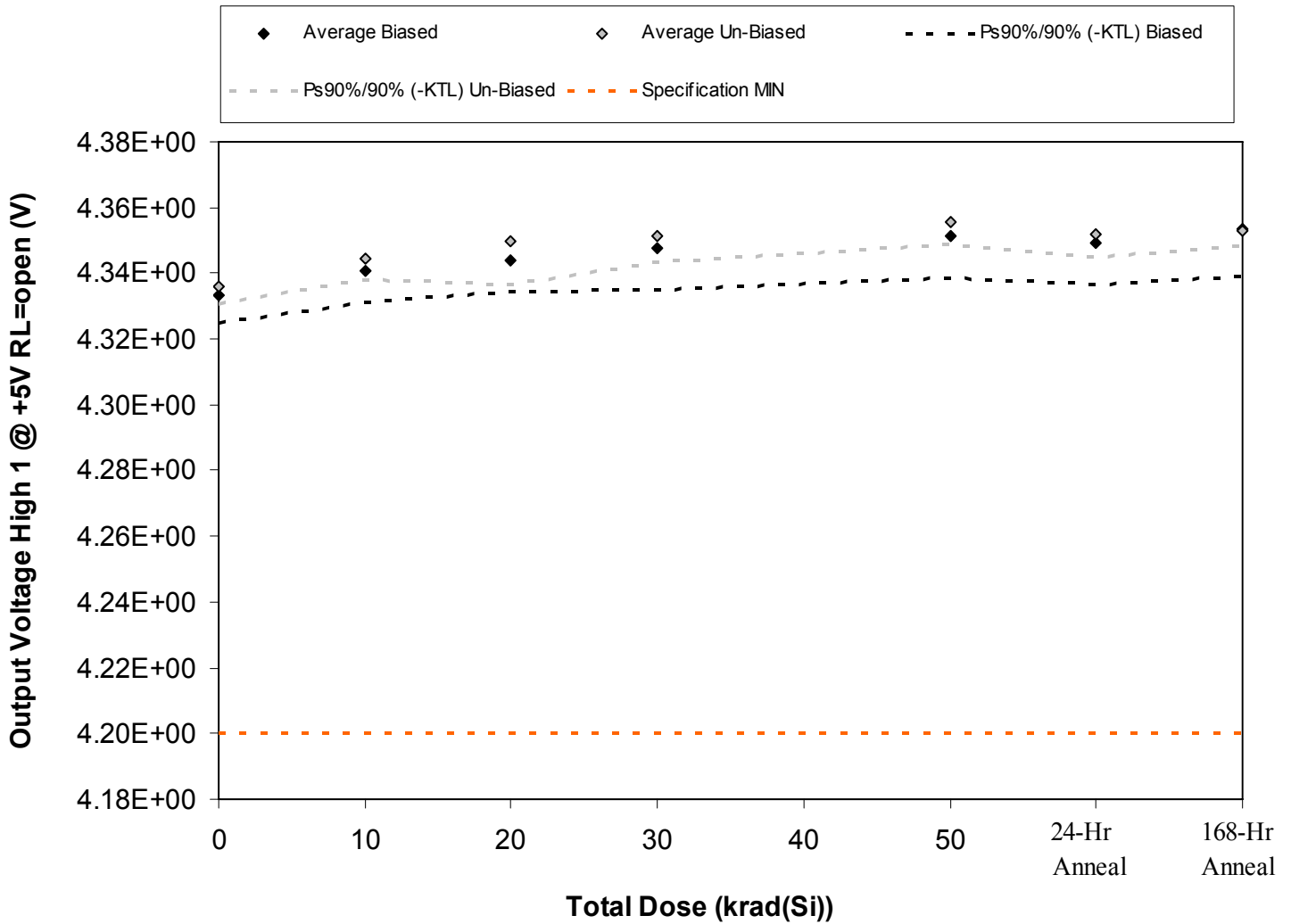

Figure 5.25. Plot of Output Voltage High 1 @ +5V RL=open (V) versus total dose. The solid diamonds are the average of the measured data points for the samples irradiated under electrical bias while the shaded diamonds are the average of the measured data points for the samples irradiated with all pins tied to ground. The black lines (solid and/or dashed) are the average of the data points after application of the KTL statistics on the samples irradiated under electrical bias while the gray lines (solid and/or dashed) are the average of the data points after application of the KTL statistics on the samples irradiated in the unbiased condition. The red dotted line(s) are the pre- and/or post-irradiation minimum and/or maximum specification value as defined in the datasheet and/or test plan.





Table 5.25. Raw data for Output Voltage High 1 @ +5V RL=open (V) versus total dose, including the statistical analysis, specification and the status of the testing (pass/fail).

Output Voltage High 1 @ +5V RL=open (V)	Total Dose (krad(Si))					24 hr Anneal	168 hr Anneal
	0	10	20	30	50		
Device							
255	4.34E+00	4.34E+00	4.35E+00	4.35E+00	4.36E+00	4.36E+00	4.36E+00
258	4.33E+00	4.34E+00	4.34E+00	4.34E+00	4.34E+00	4.34E+00	4.35E+00
309	4.33E+00	4.34E+00	4.34E+00	4.35E+00	4.35E+00	4.35E+00	4.35E+00
359	4.33E+00	4.34E+00	4.35E+00	4.35E+00	4.35E+00	4.35E+00	4.35E+00
360	4.34E+00	4.34E+00	4.35E+00	4.35E+00	4.36E+00	4.35E+00	4.36E+00
416	4.34E+00	4.35E+00	4.36E+00	4.35E+00	4.36E+00	4.35E+00	4.36E+00
472	4.33E+00	4.34E+00	4.35E+00	4.35E+00	4.35E+00	4.35E+00	4.35E+00
473	4.34E+00	4.35E+00	4.35E+00	4.36E+00	4.36E+00	4.35E+00	4.36E+00
526	4.34E+00	4.34E+00	4.35E+00	4.35E+00	4.35E+00	4.35E+00	4.35E+00
529	4.34E+00	4.35E+00	4.35E+00	4.35E+00	4.36E+00	4.35E+00	4.35E+00
530	4.34E+00	4.34E+00	4.35E+00	4.35E+00	4.34E+00	4.34E+00	4.35E+00
561	4.33E+00	4.34E+00	4.34E+00	4.34E+00	4.34E+00	4.34E+00	4.34E+00
<b>Biased Statistics</b>							
Average Biased	4.33E+00	4.34E+00	4.34E+00	4.35E+00	4.35E+00	4.35E+00	4.35E+00
Std Dev Biased	3.05E-03	3.36E-03	3.54E-03	4.51E-03	4.72E-03	4.47E-03	5.18E-03
Ps90%/90% (+KTL) Biased	4.34E+00	4.35E+00	4.35E+00	4.36E+00	4.36E+00	4.36E+00	4.37E+00
Ps90%/90% (-KTL) Biased	4.33E+00	4.33E+00	4.33E+00	4.34E+00	4.34E+00	4.34E+00	4.34E+00
<b>Un-Biased Statistics</b>							
Average Un-Biased	4.34E+00	4.34E+00	4.35E+00	4.35E+00	4.36E+00	4.35E+00	4.35E+00
Std Dev Un-Biased	1.87E-03	2.17E-03	4.87E-03	3.05E-03	2.68E-03	2.55E-03	1.79E-03
Ps90%/90% (+KTL) Un-Biased	4.34E+00	4.35E+00	4.36E+00	4.36E+00	4.36E+00	4.36E+00	4.36E+00
Ps90%/90% (-KTL) Un-Biased	4.33E+00	4.34E+00	4.34E+00	4.34E+00	4.35E+00	4.35E+00	4.35E+00
<b>Specification MIN</b>	<b>4.20E+00</b>	<b>4.20E+00</b>	<b>4.20E+00</b>	<b>4.20E+00</b>	<b>4.20E+00</b>	<b>4.20E+00</b>	<b>4.20E+00</b>
Status	PASS	PASS	PASS	PASS	PASS	PASS	PASS

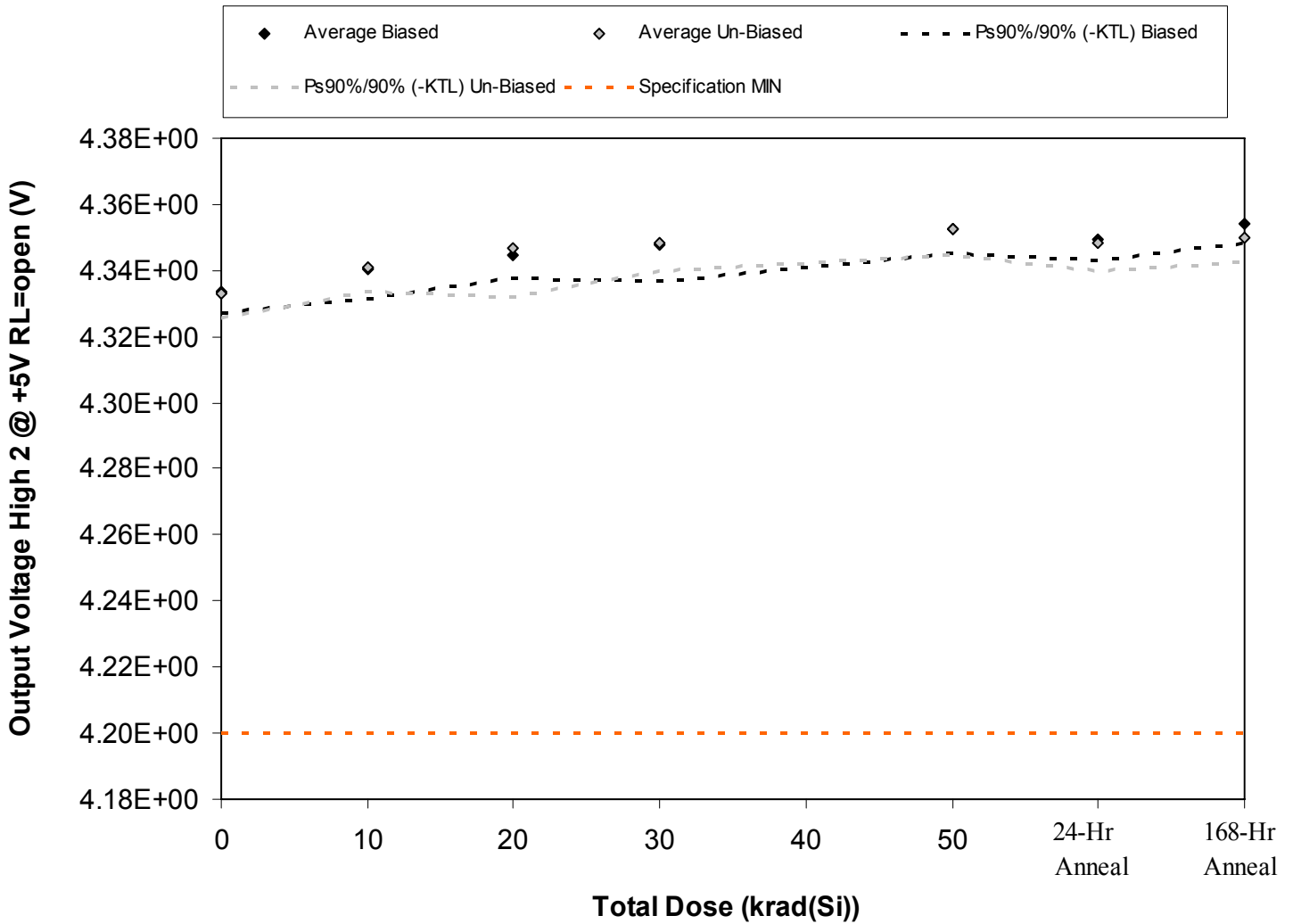

Figure 5.26. Plot of Output Voltage High 2 @ +5V RL=open (V) versus total dose. The solid diamonds are the average of the measured data points for the samples irradiated under electrical bias while the shaded diamonds are the average of the measured data points for the samples irradiated with all pins tied to ground. The black lines (solid and/or dashed) are the average of the data points after application of the KTL statistics on the samples irradiated under electrical bias while the gray lines (solid and/or dashed) are the average of the data points after application of the KTL statistics on the samples irradiated in the unbiased condition. The red dotted line(s) are the pre- and/or post-irradiation minimum and/or maximum specification value as defined in the datasheet and/or test plan.



Table 5.26. Raw data for Output Voltage High 2 @ +5V RL=open (V) versus total dose, including the statistical analysis, specification and the status of the testing (pass/fail).

Output Voltage High 2 @ +5V RL=open (V)	Total Dose (krad(Si))					24 hr Anneal	168 hr Anneal
	0	10	20	30	50		
Device							
255	4.33E+00	4.34E+00	4.34E+00	4.34E+00	4.35E+00	4.35E+00	4.35E+00
258	4.34E+00	4.34E+00	4.35E+00	4.35E+00	4.35E+00	4.35E+00	4.36E+00
309	4.33E+00	4.34E+00	4.34E+00	4.35E+00	4.35E+00	4.35E+00	4.35E+00
359	4.34E+00	4.35E+00	4.35E+00	4.35E+00	4.36E+00	4.35E+00	4.36E+00
360	4.33E+00	4.34E+00	4.35E+00	4.35E+00	4.35E+00	4.35E+00	4.36E+00
416	4.34E+00	4.34E+00	4.36E+00	4.35E+00	4.36E+00	4.35E+00	4.35E+00
472	4.33E+00	4.34E+00	4.35E+00	4.35E+00	4.35E+00	4.35E+00	4.35E+00
473	4.33E+00	4.34E+00	4.35E+00	4.35E+00	4.35E+00	4.35E+00	4.35E+00
526	4.33E+00	4.34E+00	4.34E+00	4.34E+00	4.35E+00	4.34E+00	4.35E+00
529	4.33E+00	4.34E+00	4.35E+00	4.35E+00	4.35E+00	4.35E+00	4.35E+00
530	4.33E+00	4.34E+00	4.34E+00	4.34E+00	4.34E+00	4.34E+00	4.34E+00
561	4.33E+00	4.34E+00	4.34E+00	4.34E+00	4.34E+00	4.34E+00	4.34E+00
<b>Biased Statistics</b>							
Average Biased	4.33E+00	4.34E+00	4.34E+00	4.35E+00	4.35E+00	4.35E+00	4.35E+00
Std Dev Biased	2.30E-03	3.36E-03	2.41E-03	4.04E-03	2.70E-03	2.30E-03	2.00E-03
Ps90%/90% (+KTL) Biased	4.34E+00	4.35E+00	4.35E+00	4.36E+00	4.36E+00	4.36E+00	4.36E+00
Ps90%/90% (-KTL) Biased	4.33E+00	4.33E+00	4.34E+00	4.34E+00	4.35E+00	4.34E+00	4.35E+00
<b>Un-Biased Statistics</b>							
Average Un-Biased	4.33E+00	4.34E+00	4.35E+00	4.35E+00	4.35E+00	4.35E+00	4.35E+00
Std Dev Un-Biased	2.59E-03	2.74E-03	5.36E-03	3.03E-03	2.97E-03	3.13E-03	2.74E-03
Ps90%/90% (+KTL) Un-Biased	4.34E+00	4.35E+00	4.36E+00	4.36E+00	4.36E+00	4.36E+00	4.36E+00
Ps90%/90% (-KTL) Un-Biased	4.33E+00	4.33E+00	4.33E+00	4.34E+00	4.34E+00	4.34E+00	4.34E+00
<b>Specification MIN</b>	<b>4.20E+00</b>	<b>4.20E+00</b>	<b>4.20E+00</b>	<b>4.20E+00</b>	<b>4.20E+00</b>	<b>4.20E+00</b>	<b>4.20E+00</b>
Status	PASS	PASS	PASS	PASS	PASS	PASS	PASS

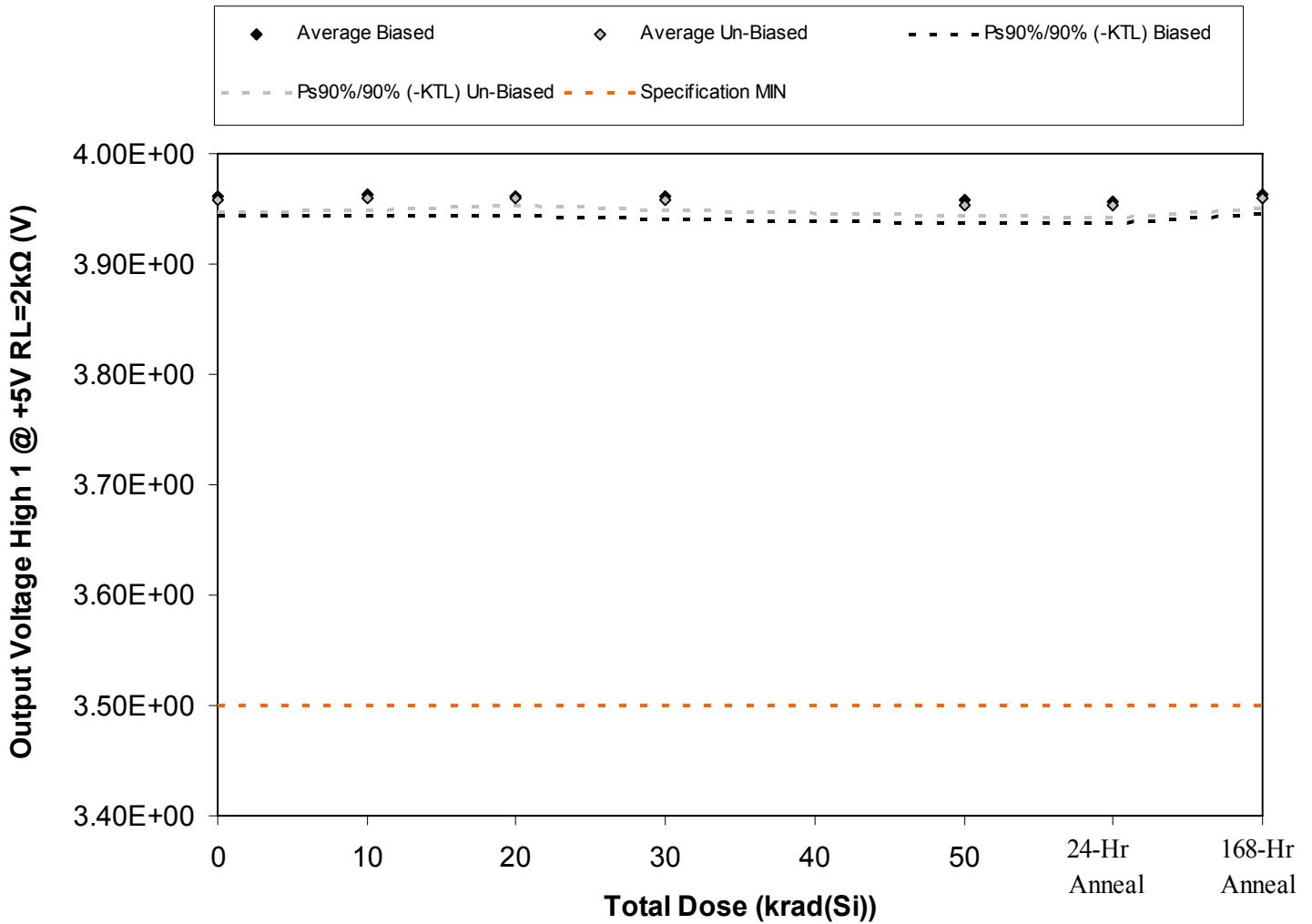

Figure 5.27. Plot of Output Voltage High 1 @ +5V RL=2kΩ (V) versus total dose. The solid diamonds are the average of the measured data points for the samples irradiated under electrical bias while the shaded diamonds are the average of the measured data points for the samples irradiated with all pins tied to ground. The black lines (solid and/or dashed) are the average of the data points after application of the KTL statistics on the samples irradiated under electrical bias while the gray lines (solid and/or dashed) are the average of the data points after application of the KTL statistics on the samples irradiated in the unbiased condition. The red dotted line(s) are the pre- and/or post-irradiation minimum and/or maximum specification value as defined in the datasheet and/or test plan.



Table 5.27. Raw data for Output Voltage High 1 @ +5V RL=2kΩ (V) versus total dose, including the statistical analysis, specification and the status of the testing (pass/fail).

Output Voltage High 1 @ +5V RL=2kΩ (V)	Total Dose (krad(Si))					24 hr Anneal	168 hr Anneal
	0	10	20	30	50		
Device							
255	3.95E+00	3.95E+00	3.95E+00	3.95E+00	3.95E+00	3.95E+00	3.95E+00
258	3.97E+00	3.97E+00	3.97E+00	3.97E+00	3.96E+00	3.96E+00	3.97E+00
309	3.96E+00	3.96E+00	3.96E+00	3.96E+00	3.96E+00	3.96E+00	3.97E+00
359	3.97E+00	3.97E+00	3.97E+00	3.97E+00	3.96E+00	3.96E+00	3.97E+00
360	3.96E+00	3.96E+00	3.96E+00	3.96E+00	3.96E+00	3.95E+00	3.96E+00
416	3.95E+00	3.95E+00	3.96E+00	3.95E+00	3.95E+00	3.95E+00	3.95E+00
472	3.96E+00	3.96E+00	3.96E+00	3.96E+00	3.95E+00	3.95E+00	3.96E+00
473	3.96E+00	3.96E+00	3.96E+00	3.96E+00	3.96E+00	3.95E+00	3.96E+00
526	3.96E+00	3.96E+00	3.96E+00	3.96E+00	3.96E+00	3.96E+00	3.96E+00
529	3.96E+00	3.96E+00	3.96E+00	3.96E+00	3.95E+00	3.95E+00	3.96E+00
530	3.97E+00	3.97E+00	3.97E+00	3.97E+00	3.97E+00	3.97E+00	3.97E+00
561	3.95E+00	3.96E+00	3.96E+00	3.96E+00	3.96E+00	3.96E+00	3.96E+00
<b>Biased Statistics</b>							
Average Biased	3.96E+00	3.96E+00	3.96E+00	3.96E+00	3.96E+00	3.96E+00	3.96E+00
Std Dev Biased	6.07E-03	6.66E-03	6.66E-03	7.53E-03	7.46E-03	7.09E-03	6.88E-03
Ps90%/90% (+KTL) Biased	3.98E+00	3.98E+00	3.98E+00	3.98E+00	3.98E+00	3.98E+00	3.98E+00
Ps90%/90% (-KTL) Biased	3.94E+00	3.94E+00	3.94E+00	3.94E+00	3.94E+00	3.94E+00	3.94E+00
<b>Un-Biased Statistics</b>							
Average Un-Biased	3.96E+00	3.96E+00	3.96E+00	3.96E+00	3.95E+00	3.95E+00	3.96E+00
Std Dev Un-Biased	3.77E-03	3.77E-03	2.17E-03	3.70E-03	3.65E-03	3.70E-03	3.81E-03
Ps90%/90% (+KTL) Un-Biased	3.97E+00	3.97E+00	3.97E+00	3.97E+00	3.96E+00	3.96E+00	3.97E+00
Ps90%/90% (-KTL) Un-Biased	3.95E+00	3.95E+00	3.95E+00	3.95E+00	3.94E+00	3.94E+00	3.95E+00
<b>Specification MIN</b>	<b>3.50E+00</b>	<b>3.50E+00</b>	<b>3.50E+00</b>	<b>3.50E+00</b>	<b>3.50E+00</b>	<b>3.50E+00</b>	<b>3.50E+00</b>
Status	PASS	PASS	PASS	PASS	PASS	PASS	PASS

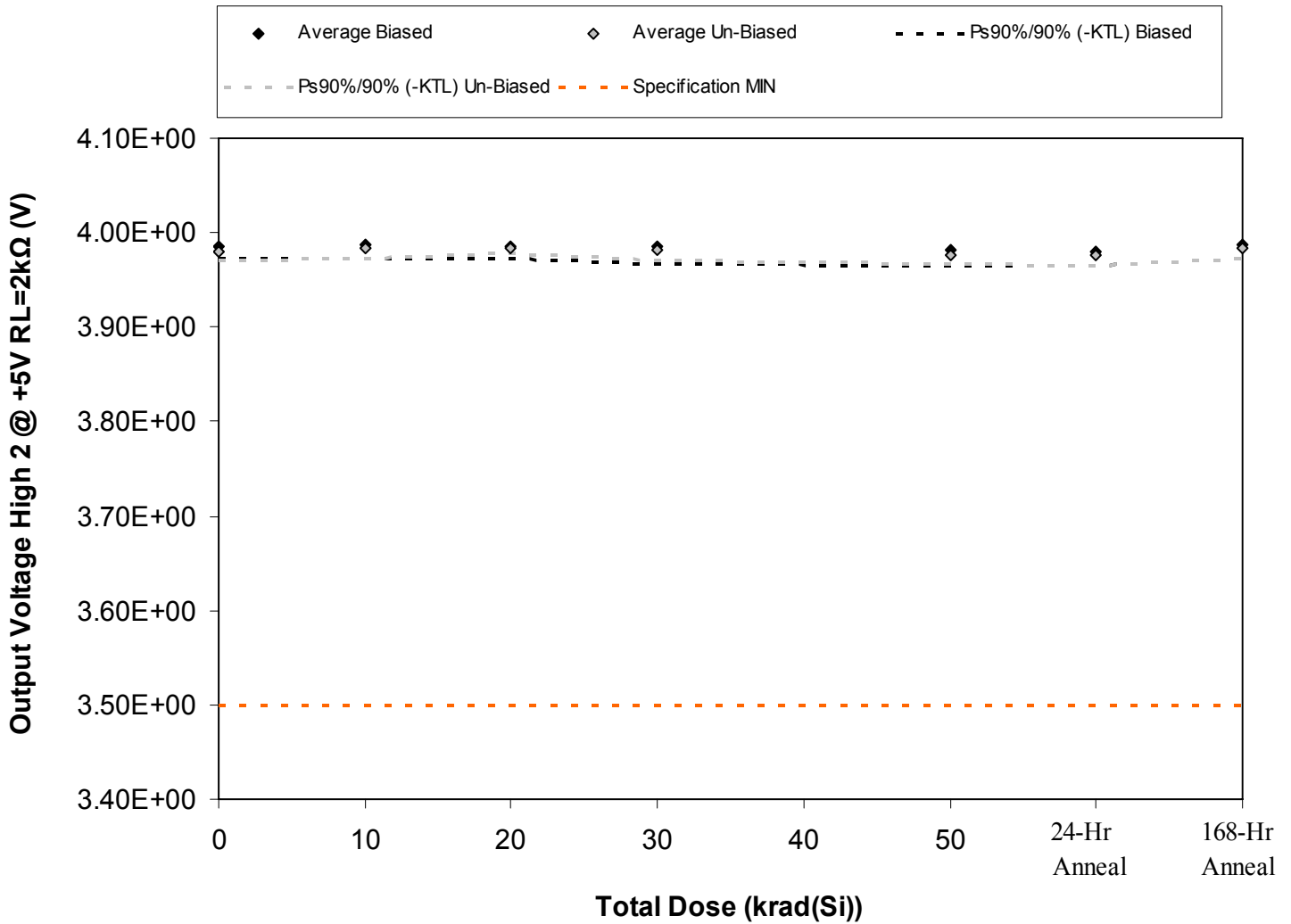

Figure 5.28. Plot of Output Voltage High 2 @ +5V RL=2kΩ (V) versus total dose. The solid diamonds are the average of the measured data points for the samples irradiated under electrical bias while the shaded diamonds are the average of the measured data points for the samples irradiated with all pins tied to ground. The black lines (solid and/or dashed) are the average of the data points after application of the KTL statistics on the samples irradiated under electrical bias while the gray lines (solid and/or dashed) are the average of the data points after application of the KTL statistics on the samples irradiated in the unbiased condition. The red dotted line(s) are the pre- and/or post-irradiation minimum and/or maximum specification value as defined in the datasheet and/or test plan.



Table 5.28. Raw data for Output Voltage High 2 @ +5V RL=2kΩ (V) versus total dose, including the statistical analysis, specification and the status of the testing (pass/fail).

Output Voltage High 2 @ +5V RL=2kΩ (V)	Total Dose (krad(Si))					24 hr Anneal	168 hr Anneal
	0	10	20	30	50		
Device							
255	3.98E+00	3.98E+00	3.98E+00	3.98E+00	3.97E+00	3.97E+00	3.98E+00
258	3.99E+00	3.99E+00	3.99E+00	3.99E+00	3.99E+00	3.99E+00	3.99E+00
309	3.99E+00	3.99E+00	3.99E+00	3.99E+00	3.99E+00	3.98E+00	3.99E+00
359	3.99E+00	3.99E+00	3.99E+00	3.99E+00	3.99E+00	3.98E+00	3.99E+00
360	3.98E+00	3.98E+00	3.98E+00	3.98E+00	3.98E+00	3.98E+00	3.99E+00
416	3.98E+00	3.98E+00	3.98E+00	3.98E+00	3.97E+00	3.97E+00	3.98E+00
472	3.98E+00	3.98E+00	3.98E+00	3.98E+00	3.98E+00	3.98E+00	3.98E+00
473	3.98E+00	3.99E+00	3.99E+00	3.99E+00	3.98E+00	3.98E+00	3.99E+00
526	3.99E+00	3.99E+00	3.99E+00	3.99E+00	3.98E+00	3.98E+00	3.99E+00
529	3.98E+00	3.98E+00	3.98E+00	3.98E+00	3.98E+00	3.98E+00	3.98E+00
530	3.99E+00	3.99E+00	4.00E+00	4.00E+00	4.00E+00	3.99E+00	4.00E+00
561	3.98E+00	3.98E+00	3.98E+00	3.98E+00	3.98E+00	3.98E+00	3.99E+00
<b>Biased Statistics</b>							
Average Biased	3.99E+00	3.99E+00	3.99E+00	3.99E+00	3.98E+00	3.98E+00	3.99E+00
Std Dev Biased	4.80E-03	5.22E-03	4.97E-03	6.53E-03	6.02E-03	5.55E-03	5.55E-03
Ps90%/90% (+KTL) Biased	4.00E+00	4.00E+00	4.00E+00	4.00E+00	4.00E+00	4.00E+00	4.00E+00
Ps90%/90% (-KTL) Biased	3.97E+00	3.97E+00	3.97E+00	3.97E+00	3.97E+00	3.97E+00	3.97E+00
<b>Un-Biased Statistics</b>							
Average Un-Biased	3.98E+00	3.98E+00	3.98E+00	3.98E+00	3.98E+00	3.98E+00	3.98E+00
Std Dev Un-Biased	3.90E-03	3.74E-03	2.30E-03	4.15E-03	3.65E-03	3.63E-03	4.09E-03
Ps90%/90% (+KTL) Un-Biased	3.99E+00	3.99E+00	3.99E+00	3.99E+00	3.99E+00	3.99E+00	3.99E+00
Ps90%/90% (-KTL) Un-Biased	3.97E+00	3.97E+00	3.98E+00	3.97E+00	3.97E+00	3.97E+00	3.97E+00
<b>Specification MIN</b>	<b>3.50E+00</b>	<b>3.50E+00</b>	<b>3.50E+00</b>	<b>3.50E+00</b>	<b>3.50E+00</b>	<b>3.50E+00</b>	<b>3.50E+00</b>
Status	PASS	PASS	PASS	PASS	PASS	PASS	PASS

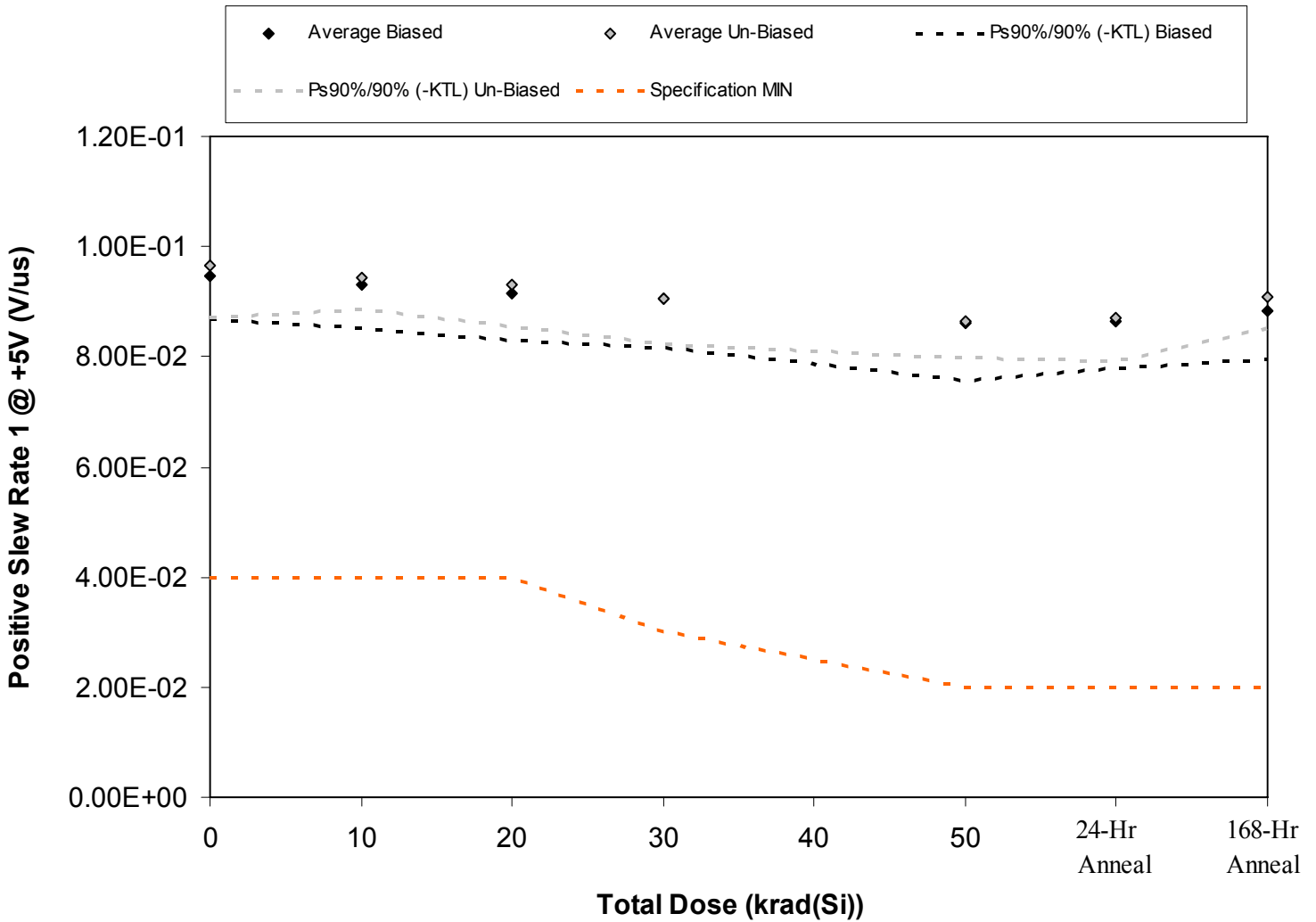

Figure 5.29. Plot of Positive Slew Rate 1 @ +5V (V/us) versus total dose. The solid diamonds are the average of the measured data points for the samples irradiated under electrical bias while the shaded diamonds are the average of the measured data points for the samples irradiated with all pins tied to ground. The black lines (solid and/or dashed) are the average of the data points after application of the KTL statistics on the samples irradiated under electrical bias while the gray lines (solid and/or dashed) are the average of the data points after application of the KTL statistics on the samples irradiated in the unbiased condition. The red dotted line(s) are the pre- and/or post-irradiation minimum and/or maximum specification value as defined in the datasheet and/or test plan.





Table 5.29. Raw data for Positive Slew Rate 1 @ +5V (V/us) versus total dose, including the statistical analysis, specification and the status of the testing (pass/fail).

Positive Slew Rate 1 @ +5V (V/us)	Total Dose (krad(Si))					24 hr Anneal	168 hr Anneal
	0	10	20	30	50		
Device	0	10	20	30	50		
255	9.10E-02	9.00E-02	8.80E-02	8.70E-02	8.10E-02	8.30E-02	8.40E-02
258	9.70E-02	9.60E-02	9.40E-02	9.30E-02	8.80E-02	8.90E-02	9.10E-02
309	9.60E-02	9.50E-02	9.30E-02	9.20E-02	8.90E-02	8.80E-02	9.00E-02
359	9.70E-02	9.50E-02	9.40E-02	9.30E-02	8.90E-02	8.90E-02	9.10E-02
360	9.20E-02	9.00E-02	8.80E-02	8.70E-02	8.30E-02	8.30E-02	8.60E-02
416	9.20E-02	9.10E-02	8.90E-02	8.60E-02	8.30E-02	8.30E-02	8.80E-02
472	1.00E-01	9.60E-02	9.50E-02	9.20E-02	8.90E-02	8.90E-02	9.30E-02
473	9.40E-02	9.40E-02	9.20E-02	8.90E-02	8.50E-02	8.50E-02	9.00E-02
526	9.90E-02	9.60E-02	9.60E-02	9.30E-02	8.80E-02	9.00E-02	9.30E-02
529	9.80E-02	9.50E-02	9.40E-02	9.30E-02	8.70E-02	8.80E-02	9.10E-02
530	9.60E-02	9.70E-02	9.80E-02	9.70E-02	9.80E-02	9.70E-02	9.70E-02
561	9.50E-02	9.50E-02	9.70E-02	9.60E-02	9.60E-02	9.60E-02	9.60E-02
<b>Biased Statistics</b>							
Average Biased	9.46E-02	9.32E-02	9.14E-02	9.04E-02	8.60E-02	8.64E-02	8.84E-02
Std Dev Biased	2.88E-03	2.95E-03	3.13E-03	3.13E-03	3.74E-03	3.13E-03	3.21E-03
Ps90%/90% (+KTL) Biased	1.02E-01	1.01E-01	1.00E-01	9.90E-02	9.63E-02	9.50E-02	9.72E-02
Ps90%/90% (-KTL) Biased	8.67E-02	8.51E-02	8.28E-02	8.18E-02	7.57E-02	7.78E-02	7.96E-02
<b>Un-Biased Statistics</b>							
Average Un-Biased	9.66E-02	9.44E-02	9.32E-02	9.06E-02	8.64E-02	8.70E-02	9.10E-02
Std Dev Un-Biased	3.44E-03	2.07E-03	2.77E-03	3.05E-03	2.41E-03	2.92E-03	2.12E-03
Ps90%/90% (+KTL) Un-Biased	1.06E-01	1.00E-01	1.01E-01	9.90E-02	9.30E-02	9.50E-02	9.68E-02
Ps90%/90% (-KTL) Un-Biased	8.72E-02	8.87E-02	8.56E-02	8.22E-02	7.98E-02	7.90E-02	8.52E-02
<b>Specification MIN</b>	<b>4.00E-02</b>	<b>4.00E-02</b>	<b>4.00E-02</b>	<b>3.00E-02</b>	<b>2.00E-02</b>	<b>2.00E-02</b>	<b>2.00E-02</b>
Status	PASS	PASS	PASS	PASS	PASS	PASS	PASS

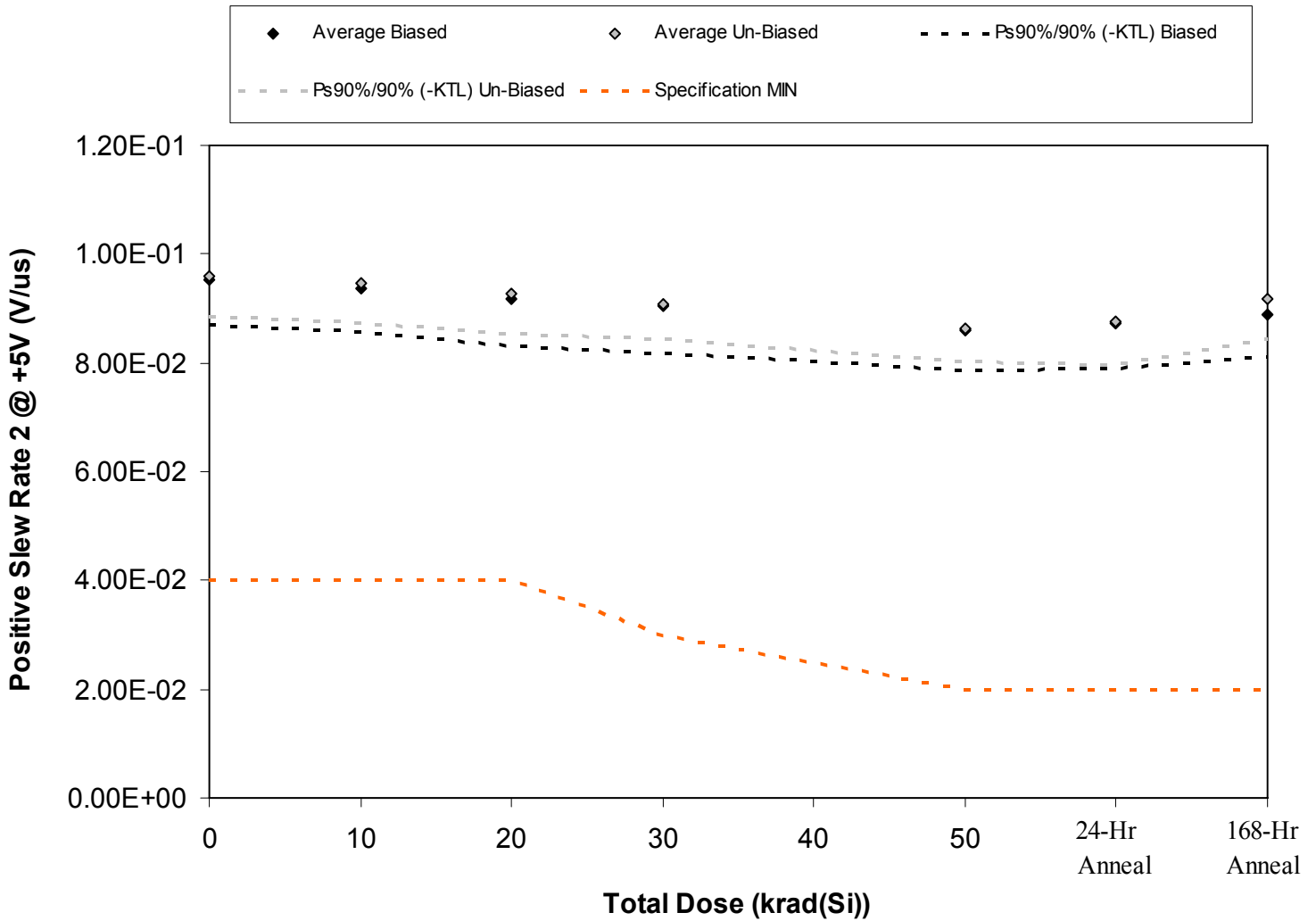

Figure 5.30. Plot of Positive Slew Rate 2 @ +5V (V/us) versus total dose. The solid diamonds are the average of the measured data points for the samples irradiated under electrical bias while the shaded diamonds are the average of the measured data points for the samples irradiated with all pins tied to ground. The black lines (solid and/or dashed) are the average of the data points after application of the KTL statistics on the samples irradiated under electrical bias while the gray lines (solid and/or dashed) are the average of the data points after application of the KTL statistics on the samples irradiated in the unbiased condition. The red dotted line(s) are the pre- and/or post-irradiation minimum and/or maximum specification value as defined in the datasheet and/or test plan.



Table 5.30. Raw data for Positive Slew Rate 2 @ +5V (V/us) versus total dose, including the statistical analysis, specification and the status of the testing (pass/fail).

Positive Slew Rate 2 @ +5V (V/us)	Total Dose (krad(Si))					24 hr Anneal	168 hr Anneal
	0	10	20	30	50		
Device	0	10	20	30	50		
255	9.20E-02	9.10E-02	8.90E-02	8.70E-02	8.30E-02	8.40E-02	8.60E-02
258	9.80E-02	9.60E-02	9.50E-02	9.30E-02	8.80E-02	9.00E-02	9.10E-02
309	9.70E-02	9.50E-02	9.30E-02	9.20E-02	8.80E-02	8.80E-02	9.00E-02
359	9.80E-02	9.60E-02	9.40E-02	9.30E-02	8.80E-02	9.00E-02	9.20E-02
360	9.20E-02	9.00E-02	8.80E-02	8.70E-02	8.30E-02	8.40E-02	8.60E-02
416	9.20E-02	9.10E-02	8.90E-02	8.70E-02	8.40E-02	8.40E-02	8.80E-02
472	9.80E-02	9.60E-02	9.50E-02	9.20E-02	8.80E-02	8.90E-02	9.40E-02
473	9.40E-02	9.30E-02	9.10E-02	9.00E-02	8.40E-02	8.50E-02	9.00E-02
526	9.80E-02	9.80E-02	9.50E-02	9.30E-02	8.90E-02	9.00E-02	9.40E-02
529	9.70E-02	9.60E-02	9.40E-02	9.20E-02	8.70E-02	9.00E-02	9.30E-02
530	9.70E-02	9.70E-02	9.80E-02	9.80E-02	9.80E-02	9.90E-02	9.80E-02
561	9.60E-02	9.50E-02	9.50E-02	9.50E-02	9.60E-02	9.40E-02	9.60E-02
<b>Biased Statistics</b>							
Average Biased	9.54E-02	9.36E-02	9.18E-02	9.04E-02	8.60E-02	8.72E-02	8.90E-02
Std Dev Biased	3.13E-03	2.88E-03	3.11E-03	3.13E-03	2.74E-03	3.03E-03	2.83E-03
Ps90%/90% (+KTL) Biased	1.04E-01	1.01E-01	1.00E-01	9.90E-02	9.35E-02	9.55E-02	9.68E-02
Ps90%/90% (-KTL) Biased	8.68E-02	8.57E-02	8.33E-02	8.18E-02	7.85E-02	7.89E-02	8.12E-02
<b>Un-Biased Statistics</b>							
Average Un-Biased	9.58E-02	9.48E-02	9.28E-02	9.08E-02	8.64E-02	8.76E-02	9.18E-02
Std Dev Un-Biased	2.68E-03	2.77E-03	2.68E-03	2.39E-03	2.30E-03	2.88E-03	2.68E-03
Ps90%/90% (+KTL) Un-Biased	1.03E-01	1.02E-01	1.00E-01	9.73E-02	9.27E-02	9.55E-02	9.92E-02
Ps90%/90% (-KTL) Un-Biased	8.84E-02	8.72E-02	8.54E-02	8.43E-02	8.01E-02	7.97E-02	8.44E-02
<b>Specification MIN</b>	<b>4.00E-02</b>	<b>4.00E-02</b>	<b>4.00E-02</b>	<b>3.00E-02</b>	<b>2.00E-02</b>	<b>2.00E-02</b>	<b>2.00E-02</b>
Status	PASS	PASS	PASS	PASS	PASS	PASS	PASS

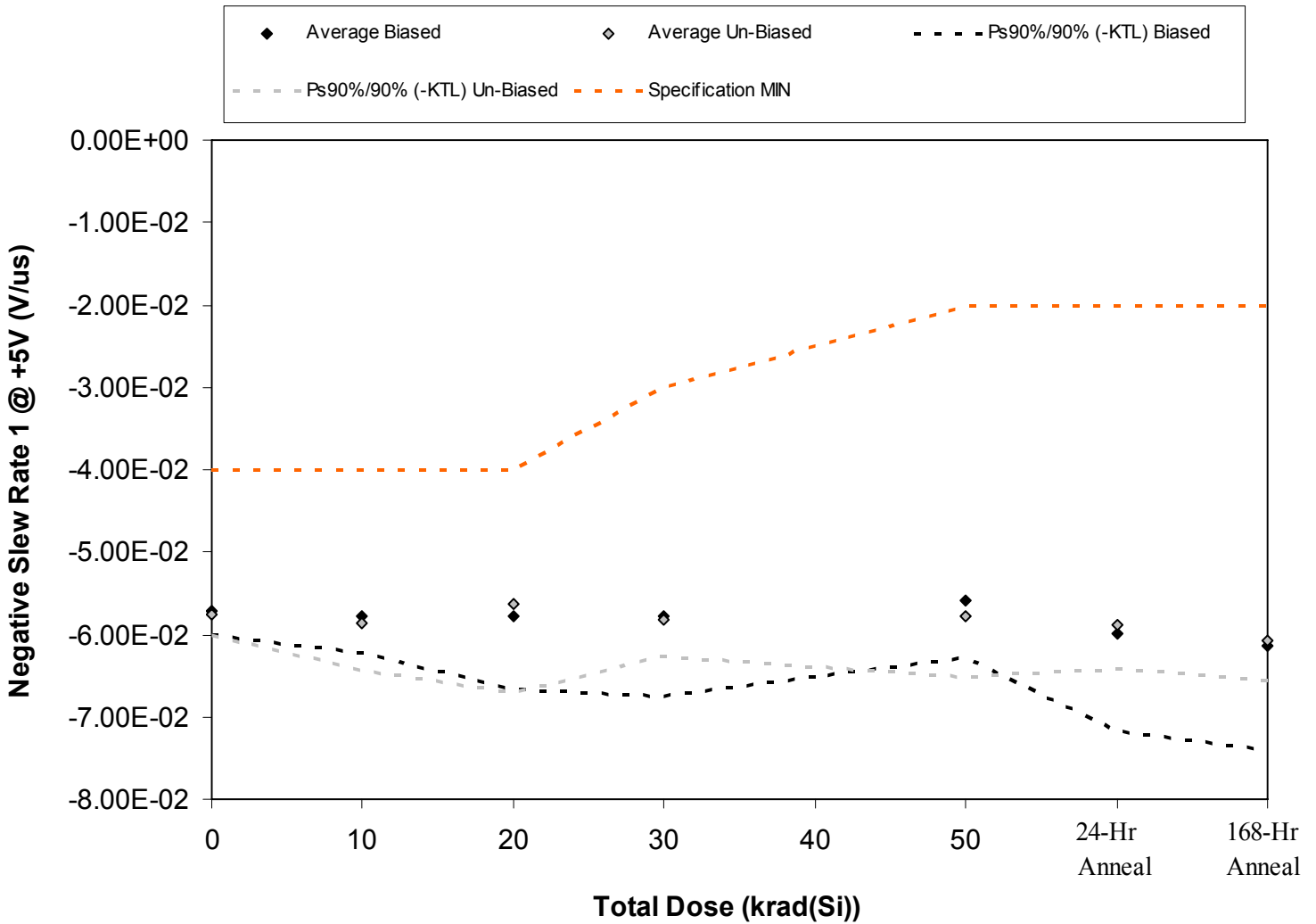

Figure 5.31. Plot of Negative Slew Rate 1 @ +5V (V/us) versus total dose. The solid diamonds are the average of the measured data points for the samples irradiated under electrical bias while the shaded diamonds are the average of the measured data points for the samples irradiated with all pins tied to ground. The black lines (solid and/or dashed) are the average of the data points after application of the KTL statistics on the samples irradiated under electrical bias while the gray lines (solid and/or dashed) are the average of the data points after application of the KTL statistics on the samples irradiated in the unbiased condition. The red dotted line(s) are the pre- and/or post-irradiation minimum and/or maximum specification value as defined in the datasheet and/or test plan.



Table 5.31. Raw data for Negative Slew Rate 1 @ +5V (V/us) versus total dose, including the statistical analysis, specification and the status of the testing (pass/fail).

Negative Slew Rate 1 @ +5V (V/us)	Total Dose (krad(Si))					24 hr Anneal	168 hr Anneal
	0	10	20	30	50		
Device							
255	-5.60E-02	-5.60E-02	-5.40E-02	-5.40E-02	-5.30E-02	-5.40E-02	-5.50E-02
258	-5.80E-02	-5.90E-02	-6.20E-02	-6.30E-02	-5.30E-02	-6.50E-02	-6.70E-02
309	-5.80E-02	-5.90E-02	-5.90E-02	-5.80E-02	-5.80E-02	-6.20E-02	-6.40E-02
359	-5.80E-02	-5.90E-02	-5.90E-02	-5.90E-02	-5.80E-02	-6.10E-02	-6.20E-02
360	-5.60E-02	-5.60E-02	-5.50E-02	-5.50E-02	-5.70E-02	-5.70E-02	-5.90E-02
416	-5.70E-02	-5.50E-02	-5.60E-02	-5.60E-02	-5.40E-02	-5.60E-02	-5.80E-02
472	-5.80E-02	-6.00E-02	-5.00E-02	-6.00E-02	-6.00E-02	-6.10E-02	-6.20E-02
473	-5.70E-02	-5.90E-02	-5.70E-02	-5.70E-02	-5.60E-02	-5.80E-02	-6.00E-02
526	-5.90E-02	-6.00E-02	-5.90E-02	-5.90E-02	-5.90E-02	-6.00E-02	-6.20E-02
529	-5.70E-02	-5.90E-02	-6.00E-02	-5.90E-02	-6.00E-02	-5.90E-02	-6.20E-02
530	-5.80E-02	-5.90E-02	-6.00E-02	-6.00E-02	-6.00E-02	-6.00E-02	-6.00E-02
561	-5.60E-02	-5.80E-02	-5.70E-02	-5.90E-02	-5.80E-02	-5.80E-02	-6.00E-02
<b>Biased Statistics</b>							
Average Biased	-5.72E-02	-5.78E-02	-5.78E-02	-5.78E-02	-5.58E-02	-5.98E-02	-6.14E-02
Std Dev Biased	1.10E-03	1.64E-03	3.27E-03	3.56E-03	2.59E-03	4.32E-03	4.62E-03
Ps90%/90% (+KTL) Biased	-5.42E-02	-5.33E-02	-4.88E-02	-4.80E-02	-4.87E-02	-4.79E-02	-4.87E-02
Ps90%/90% (-KTL) Biased	-6.02E-02	-6.23E-02	-6.68E-02	-6.76E-02	-6.29E-02	-7.17E-02	-7.41E-02
<b>Un-Biased Statistics</b>							
Average Un-Biased	-5.76E-02	-5.86E-02	-5.64E-02	-5.82E-02	-5.78E-02	-5.88E-02	-6.08E-02
Std Dev Un-Biased	8.94E-04	2.07E-03	3.91E-03	1.64E-03	2.68E-03	1.92E-03	1.79E-03
Ps90%/90% (+KTL) Un-Biased	-5.51E-02	-5.29E-02	-4.57E-02	-5.37E-02	-5.04E-02	-5.35E-02	-5.59E-02
Ps90%/90% (-KTL) Un-Biased	-6.01E-02	-6.43E-02	-6.71E-02	-6.27E-02	-6.52E-02	-6.41E-02	-6.57E-02
<b>Specification MIN</b>	<b>-4.00E-02</b>	<b>-4.00E-02</b>	<b>-4.00E-02</b>	<b>-3.00E-02</b>	<b>-2.00E-02</b>	<b>-2.00E-02</b>	<b>-2.00E-02</b>
Status	PASS	PASS	PASS	PASS	PASS	PASS	PASS

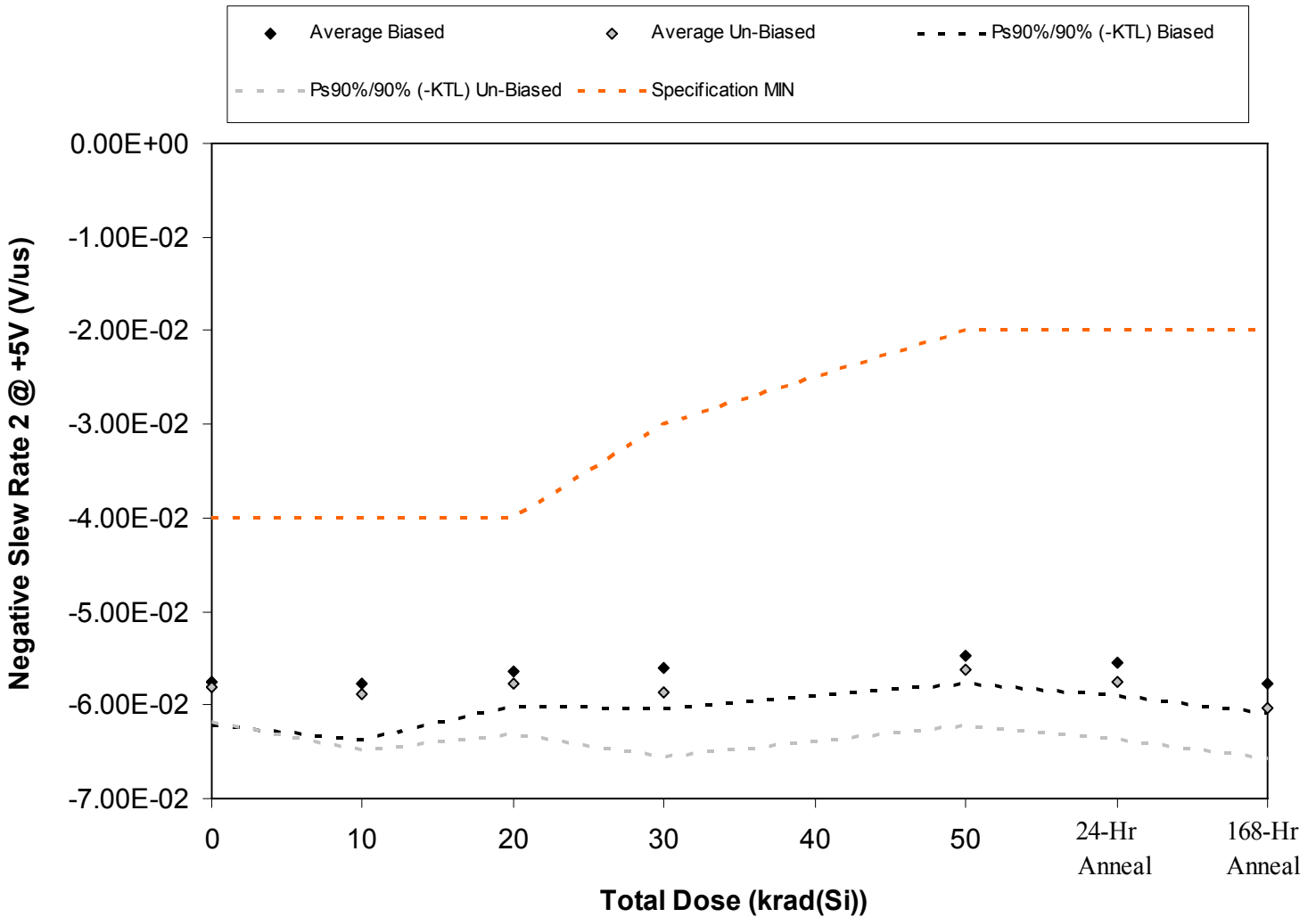

Figure 5.32. Plot of Negative Slew Rate 2 @ +5V (V/us) versus total dose. The solid diamonds are the average of the measured data points for the samples irradiated under electrical bias while the shaded diamonds are the average of the measured data points for the samples irradiated with all pins tied to ground. The black lines (solid and/or dashed) are the average of the data points after application of the KTL statistics on the samples irradiated under electrical bias while the gray lines (solid and/or dashed) are the average of the data points after application of the KTL statistics on the samples irradiated in the unbiased condition. The red dotted line(s) are the pre- and/or post-irradiation minimum and/or maximum specification value as defined in the datasheet and/or test plan.



Table 5.32. Raw data for Negative Slew Rate 2 @ +5V (V/us) versus total dose, including the statistical analysis, specification and the status of the testing (pass/fail).

Negative Slew Rate 2 @ +5V (V/us)	Total Dose (krad(Si))					24 hr Anneal	168 hr Anneal
	0	10	20	30	50		
Device							
255	-5.60E-02	-5.50E-02	-5.50E-02	-5.50E-02	-5.40E-02	-5.40E-02	-5.80E-02
258	-5.80E-02	-5.90E-02	-5.70E-02	-5.60E-02	-5.40E-02	-5.60E-02	-5.80E-02
309	-5.80E-02	-5.90E-02	-5.70E-02	-5.70E-02	-5.60E-02	-5.70E-02	-5.90E-02
359	-6.00E-02	-6.00E-02	-5.80E-02	-5.80E-02	-5.60E-02	-5.60E-02	-5.80E-02
360	-5.60E-02	-5.60E-02	-5.50E-02	-5.40E-02	-5.40E-02	-5.40E-02	-5.60E-02
416	-5.60E-02	-5.60E-02	-5.50E-02	-5.50E-02	-5.30E-02	-5.40E-02	-5.70E-02
472	-5.90E-02	-5.90E-02	-5.80E-02	-5.80E-02	-5.60E-02	-5.80E-02	-6.10E-02
473	-5.70E-02	-5.80E-02	-5.70E-02	-5.80E-02	-5.60E-02	-5.80E-02	-6.10E-02
526	-5.90E-02	-6.20E-02	-6.00E-02	-6.10E-02	-5.90E-02	-6.00E-02	-6.20E-02
529	-5.90E-02	-5.90E-02	-5.90E-02	-6.10E-02	-5.70E-02	-5.80E-02	-6.10E-02
530	-5.80E-02	-6.00E-02	-6.10E-02	-6.00E-02	-6.00E-02	-6.10E-02	-6.10E-02
561	-5.70E-02	-6.00E-02	-5.70E-02	-5.80E-02	-5.80E-02	-5.80E-02	-5.90E-02
<b>Biased Statistics</b>							
Average Biased	-5.76E-02	-5.78E-02	-5.64E-02	-5.60E-02	-5.48E-02	-5.54E-02	-5.78E-02
Std Dev Biased	1.67E-03	2.17E-03	1.34E-03	1.58E-03	1.10E-03	1.34E-03	1.10E-03
Ps90%/90% (+KTL) Biased	-5.30E-02	-5.19E-02	-5.27E-02	-5.17E-02	-5.18E-02	-5.17E-02	-5.48E-02
Ps90%/90% (-KTL) Biased	-6.22E-02	-6.37E-02	-6.01E-02	-6.03E-02	-5.78E-02	-5.91E-02	-6.08E-02
<b>Un-Biased Statistics</b>							
Average Un-Biased	-5.80E-02	-5.88E-02	-5.78E-02	-5.86E-02	-5.62E-02	-5.76E-02	-6.04E-02
Std Dev Un-Biased	1.41E-03	2.17E-03	1.92E-03	2.51E-03	2.17E-03	2.19E-03	1.95E-03
Ps90%/90% (+KTL) Un-Biased	-5.41E-02	-5.29E-02	-5.25E-02	-5.17E-02	-5.03E-02	-5.16E-02	-5.51E-02
Ps90%/90% (-KTL) Un-Biased	-6.19E-02	-6.47E-02	-6.31E-02	-6.55E-02	-6.21E-02	-6.36E-02	-6.57E-02
<b>Specification MIN</b>	<b>-4.00E-02</b>	<b>-4.00E-02</b>	<b>-4.00E-02</b>	<b>-3.00E-02</b>	<b>-2.00E-02</b>	<b>-2.00E-02</b>	<b>-2.00E-02</b>
Status	PASS	PASS	PASS	PASS	PASS	PASS	PASS

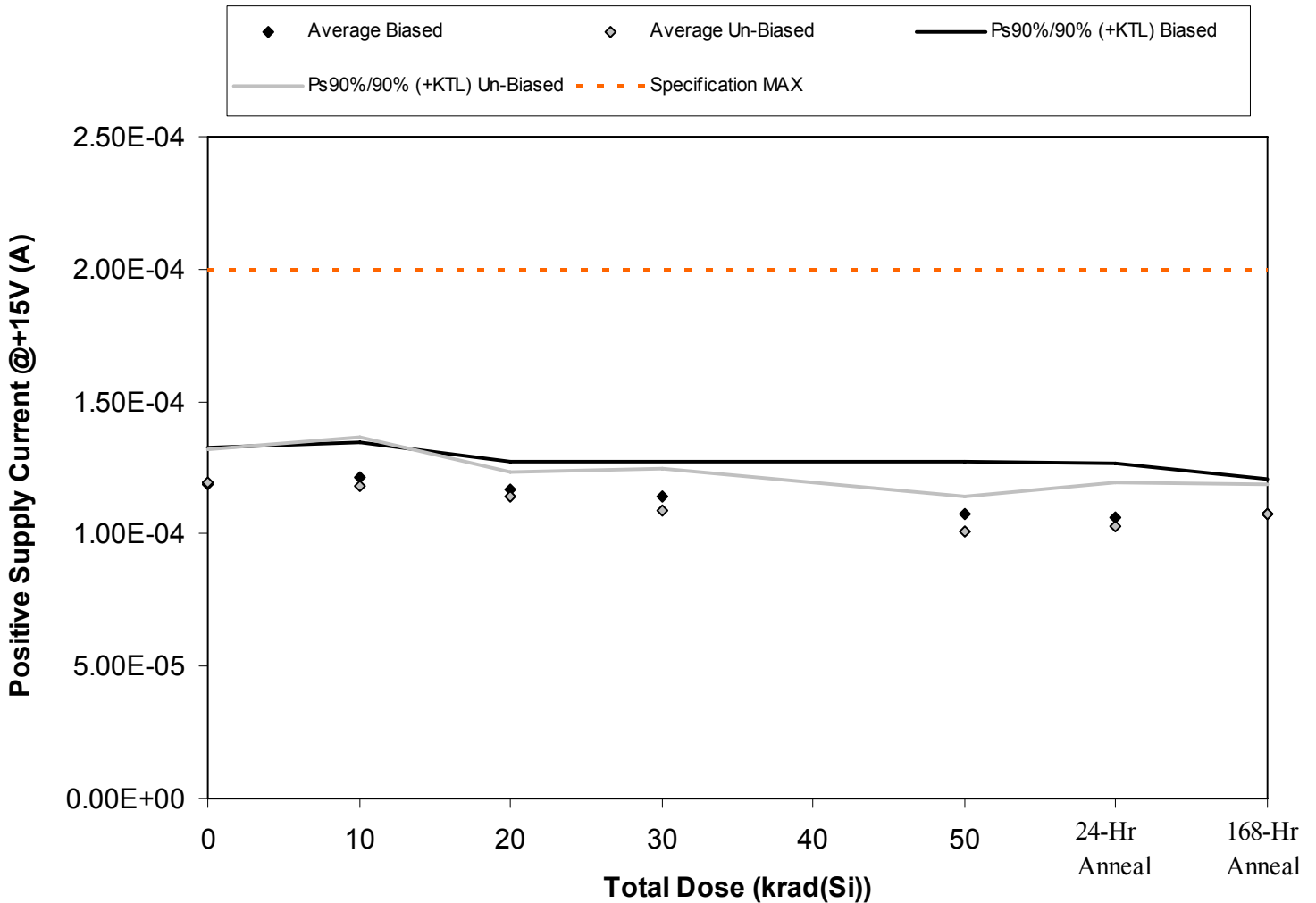

Figure 5.33. Plot of Positive Supply Current @+15V (A) versus total dose. The solid diamonds are the average of the measured data points for the samples irradiated under electrical bias while the shaded diamonds are the average of the measured data points for the samples irradiated with all pins tied to ground. The black lines (solid and/or dashed) are the average of the data points after application of the KTL statistics on the samples irradiated under electrical bias while the gray lines (solid and/or dashed) are the average of the data points after application of the KTL statistics on the samples irradiated in the unbiased condition. The red dotted line(s) are the pre- and/or post-irradiation minimum and/or maximum specification value as defined in the datasheet and/or test plan.





**TID Report  
10-004 100412 R1.0**

**Radiation Assured Devices  
5017 N. 30th Street  
Colorado Springs, CO 80919  
(719) 531-0800**

Table 5.33. Raw data for Positive Supply Current @+15V (A) versus total dose, including the statistical analysis, specification and the status of the testing (pass/fail).

Positive Supply Current @+15V (A)	Total Dose (krad(Si))					24 hr Anneal	168 hr Anneal
	0	10	20	30	50		
Device							
255	1.14E-04	1.15E-04	1.12E-04	1.11E-04	1.00E-04	9.70E-05	1.00E-04
258	1.27E-04	1.26E-04	1.19E-04	1.15E-04	1.13E-04	1.10E-04	1.11E-04
309	1.20E-04	1.26E-04	1.15E-04	1.22E-04	1.17E-04	1.16E-04	1.09E-04
359	1.17E-04	1.22E-04	1.22E-04	1.10E-04	1.05E-04	1.07E-04	1.12E-04
360	1.16E-04	1.18E-04	1.16E-04	1.11E-04	1.02E-04	1.01E-04	1.05E-04
416	1.13E-04	1.08E-04	1.10E-04	1.03E-04	9.60E-05	9.90E-05	1.03E-04
472	1.21E-04	1.23E-04	1.12E-04	1.12E-04	1.00E-04	1.00E-04	1.04E-04
473	1.17E-04	1.16E-04	1.14E-04	1.08E-04	9.90E-05	9.80E-05	1.08E-04
526	1.24E-04	1.25E-04	1.19E-04	1.17E-04	1.09E-04	1.09E-04	1.14E-04
529	1.23E-04	1.19E-04	1.15E-04	1.05E-04	1.00E-04	1.10E-04	1.07E-04
530	1.18E-04	1.25E-04	1.22E-04	1.25E-04	1.26E-04	1.19E-04	1.17E-04
561	1.15E-04	1.18E-04	1.21E-04	1.20E-04	1.17E-04	1.14E-04	1.18E-04
<b>Biased Statistics</b>							
Average Biased	1.19E-04	1.21E-04	1.17E-04	1.14E-04	1.07E-04	1.06E-04	1.07E-04
Std Dev Biased	5.07E-06	4.88E-06	3.83E-06	4.97E-06	7.30E-06	7.46E-06	4.93E-06
Ps90%/90% (+KTL) Biased	1.33E-04	1.35E-04	1.27E-04	1.27E-04	1.27E-04	1.27E-04	1.21E-04
Ps90%/90% (-KTL) Biased	1.05E-04	1.08E-04	1.06E-04	1.00E-04	8.74E-05	8.57E-05	9.39E-05
<b>Un-Biased Statistics</b>							
Average Un-Biased	1.20E-04	1.18E-04	1.14E-04	1.09E-04	1.01E-04	1.03E-04	1.07E-04
Std Dev Un-Biased	4.56E-06	6.69E-06	3.39E-06	5.61E-06	4.87E-06	5.81E-06	4.32E-06
Ps90%/90% (+KTL) Un-Biased	1.32E-04	1.37E-04	1.23E-04	1.24E-04	1.14E-04	1.19E-04	1.19E-04
Ps90%/90% (-KTL) Un-Biased	1.07E-04	9.99E-05	1.05E-04	9.36E-05	8.75E-05	8.73E-05	9.53E-05
<b>Specification MAX</b>	<b>2.00E-04</b>	<b>2.00E-04</b>	<b>2.00E-04</b>	<b>2.00E-04</b>	<b>2.00E-04</b>	<b>2.00E-04</b>	<b>2.00E-04</b>
Status	PASS	PASS	PASS	PASS	PASS	PASS	PASS

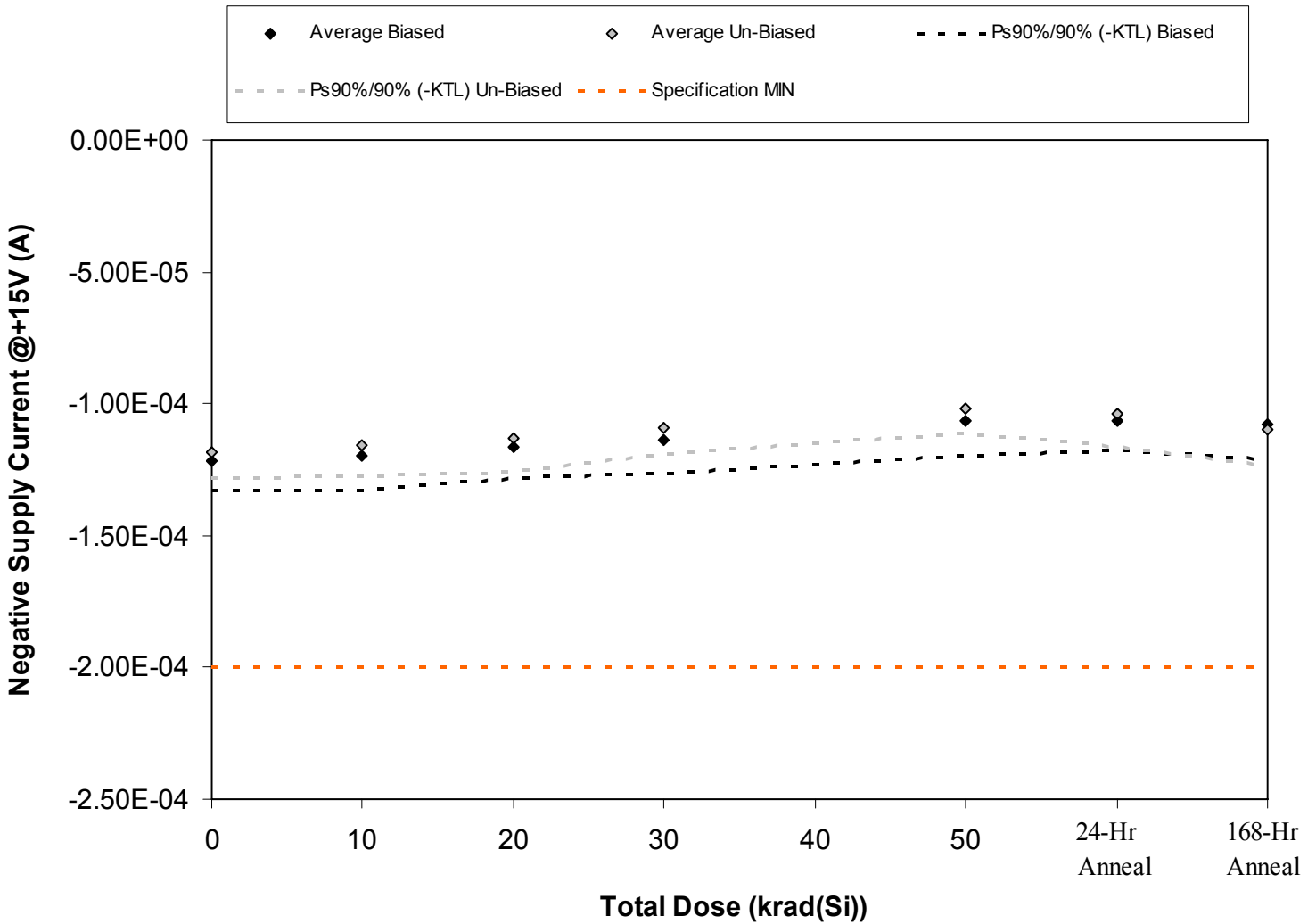

Figure 5.34. Plot of Negative Supply Current @+15V (A) versus total dose. The solid diamonds are the average of the measured data points for the samples irradiated under electrical bias while the shaded diamonds are the average of the measured data points for the samples irradiated with all pins tied to ground. The black lines (solid and/or dashed) are the average of the data points after application of the KTL statistics on the samples irradiated under electrical bias while the gray lines (solid and/or dashed) are the average of the data points after application of the KTL statistics on the samples irradiated in the unbiased condition. The red dotted line(s) are the pre- and/or post-irradiation minimum and/or maximum specification value as defined in the datasheet and/or test plan.



Table 5.34. Raw data for Negative Supply Current @+15V (A) versus total dose, including the statistical analysis, specification and the status of the testing (pass/fail).

Negative Supply Current @+15V (A)	Total Dose (krad(Si))					24 hr Anneal	168 hr Anneal
	0	10	20	30	50		
Device							
255	-1.18E-04	-1.12E-04	-1.12E-04	-1.08E-04	-1.01E-04	-1.02E-04	-1.02E-04
258	-1.27E-04	-1.25E-04	-1.22E-04	-1.20E-04	-1.12E-04	-1.12E-04	-1.13E-04
309	-1.24E-04	-1.22E-04	-1.20E-04	-1.16E-04	-1.09E-04	-1.09E-04	-1.12E-04
359	-1.23E-04	-1.21E-04	-1.16E-04	-1.14E-04	-1.09E-04	-1.07E-04	-1.09E-04
360	-1.18E-04	-1.17E-04	-1.13E-04	-1.11E-04	-1.03E-04	-1.04E-04	-1.04E-04
416	-1.14E-04	-1.11E-04	-1.08E-04	-1.04E-04	-9.70E-05	-9.70E-05	-1.03E-04
472	-1.19E-04	-1.15E-04	-1.13E-04	-1.10E-04	-1.03E-04	-1.07E-04	-1.10E-04
473	-1.18E-04	-1.15E-04	-1.14E-04	-1.10E-04	-1.02E-04	-1.03E-04	-1.09E-04
526	-1.24E-04	-1.23E-04	-1.20E-04	-1.14E-04	-1.06E-04	-1.09E-04	-1.17E-04
529	-1.18E-04	-1.16E-04	-1.11E-04	-1.09E-04	-1.02E-04	-1.02E-04	-1.10E-04
530	-1.21E-04	-1.22E-04	-1.21E-04	-1.22E-04	-1.20E-04	-1.22E-04	-1.22E-04
561	-1.18E-04	-1.18E-04	-1.20E-04	-1.20E-04	-1.20E-04	-1.19E-04	-1.19E-04
<b>Biased Statistics</b>							
Average Biased	-1.22E-04	-1.19E-04	-1.17E-04	-1.14E-04	-1.07E-04	-1.07E-04	-1.08E-04
Std Dev Biased	3.94E-06	5.03E-06	4.34E-06	4.60E-06	4.60E-06	3.96E-06	4.85E-06
Ps90%/90% (+KTL) Biased	-1.11E-04	-1.06E-04	-1.05E-04	-1.01E-04	-9.42E-05	-9.59E-05	-9.47E-05
Ps90%/90% (-KTL) Biased	-1.33E-04	-1.33E-04	-1.28E-04	-1.26E-04	-1.19E-04	-1.18E-04	-1.21E-04
<b>Un-Biased Statistics</b>							
Average Un-Biased	-1.19E-04	-1.16E-04	-1.13E-04	-1.09E-04	-1.02E-04	-1.04E-04	-1.10E-04
Std Dev Un-Biased	3.58E-06	4.36E-06	4.44E-06	3.58E-06	3.24E-06	4.67E-06	4.97E-06
Ps90%/90% (+KTL) Un-Biased	-1.09E-04	-1.04E-04	-1.01E-04	-9.96E-05	-9.31E-05	-9.08E-05	-9.62E-05
Ps90%/90% (-KTL) Un-Biased	-1.28E-04	-1.28E-04	-1.25E-04	-1.19E-04	-1.11E-04	-1.16E-04	-1.23E-04
<b>Specification MIN</b>	<b>-2.00E-04</b>	<b>-2.00E-04</b>	<b>-2.00E-04</b>	<b>-2.00E-04</b>	<b>-2.00E-04</b>	<b>-2.00E-04</b>	<b>-2.00E-04</b>
Status	PASS	PASS	PASS	PASS	PASS	PASS	PASS

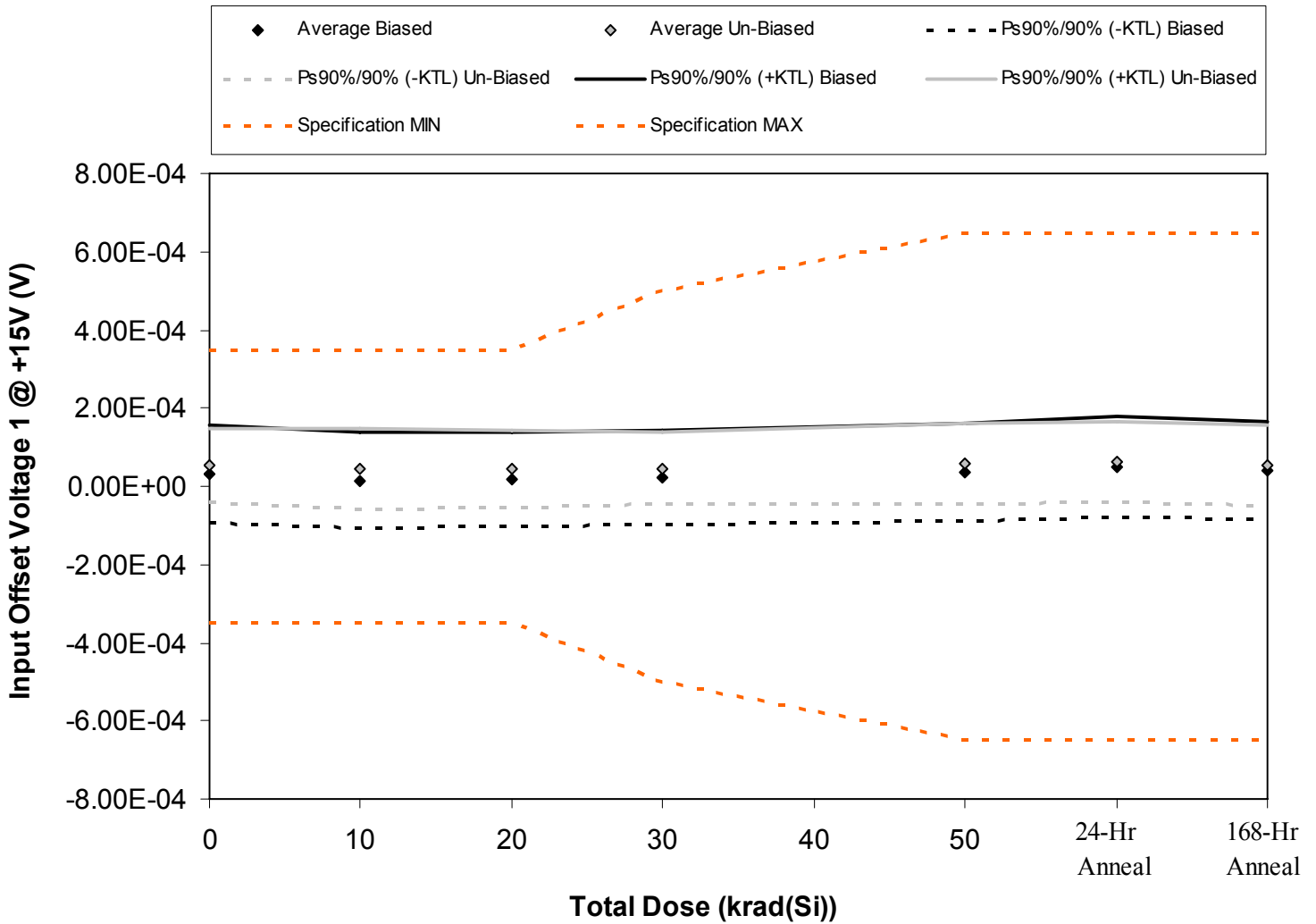

Figure 5.35. Plot of Input Offset Voltage 1 @ +15V (V) versus total dose. The solid diamonds are the average of the measured data points for the samples irradiated under electrical bias while the shaded diamonds are the average of the measured data points for the samples irradiated with all pins tied to ground. The black lines (solid and/or dashed) are the average of the data points after application of the KTL statistics on the samples irradiated under electrical bias while the gray lines (solid and/or dashed) are the average of the data points after application of the KTL statistics on the samples irradiated in the unbiased condition. The red dotted line(s) are the pre- and/or post-irradiation minimum and/or maximum specification value as defined in the datasheet and/or test plan.



Table 5.35. Raw data for Input Offset Voltage 1 @ +15V (V) versus total dose, including the statistical analysis, specification and the status of the testing (pass/fail).

Input Offset Voltage 1 @ +15V (V)	Total Dose (krad(Si))					24 hr Anneal	168 hr Anneal
	0	10	20	30	50		
Device							
255	4.80E-05	3.27E-05	3.06E-05	4.22E-05	6.81E-05	8.10E-05	7.05E-05
258	3.92E-05	2.11E-05	2.16E-05	3.11E-05	4.56E-05	5.48E-05	3.99E-05
309	8.51E-05	6.74E-05	7.47E-05	7.41E-05	7.88E-05	9.38E-05	8.47E-05
359	-3.76E-05	-5.46E-05	-4.79E-05	-4.48E-05	-3.68E-05	-2.61E-05	-3.29E-05
360	1.94E-05	7.49E-06	1.11E-05	1.66E-05	2.70E-05	3.93E-05	4.22E-05
416	4.03E-05	3.28E-05	3.44E-05	3.99E-05	4.82E-05	5.09E-05	4.31E-05
472	3.97E-06	-7.60E-06	-5.20E-06	-4.12E-06	4.33E-06	4.08E-06	4.56E-07
473	8.44E-05	7.68E-05	7.27E-05	7.17E-05	8.94E-05	9.00E-05	7.43E-05
526	8.74E-05	8.43E-05	8.40E-05	8.36E-05	9.87E-05	9.91E-05	9.98E-05
529	5.39E-05	4.08E-05	3.85E-05	4.15E-05	5.70E-05	5.84E-05	5.20E-05
530	2.82E-05	2.73E-05	2.67E-05	3.05E-05	2.80E-05	3.05E-05	2.88E-05
561	2.12E-05	2.40E-05	2.37E-05	2.50E-05	2.19E-05	2.98E-05	2.68E-05
<b>Biased Statistics</b>							
Average Biased	3.08E-05	1.48E-05	1.80E-05	2.39E-05	3.65E-05	4.86E-05	4.09E-05
Std Dev Biased	4.50E-05	4.47E-05	4.41E-05	4.38E-05	4.57E-05	4.69E-05	4.54E-05
Ps90%/90% (+KTL) Biased	1.54E-04	1.37E-04	1.39E-04	1.44E-04	1.62E-04	1.77E-04	1.65E-04
Ps90%/90% (-KTL) Biased	-9.27E-05	-1.08E-04	-1.03E-04	-9.63E-05	-8.87E-05	-8.00E-05	-8.35E-05
<b>Un-Biased Statistics</b>							
Average Un-Biased	5.40E-05	4.54E-05	4.49E-05	4.65E-05	5.95E-05	6.05E-05	5.39E-05
Std Dev Un-Biased	3.44E-05	3.70E-05	3.52E-05	3.41E-05	3.75E-05	3.76E-05	3.71E-05
Ps90%/90% (+KTL) Un-Biased	1.48E-04	1.47E-04	1.41E-04	1.40E-04	1.62E-04	1.63E-04	1.56E-04
Ps90%/90% (-KTL) Un-Biased	-4.03E-05	-5.61E-05	-5.17E-05	-4.69E-05	-4.32E-05	-4.25E-05	-4.78E-05
<b>Specification MIN</b>	<b>-3.50E-04</b>	<b>-3.50E-04</b>	<b>-3.50E-04</b>	<b>-5.00E-04</b>	<b>-6.50E-04</b>	<b>-6.50E-04</b>	<b>-6.50E-04</b>
Status	PASS	PASS	PASS	PASS	PASS	PASS	PASS
<b>Specification MAX</b>	<b>3.50E-04</b>	<b>3.50E-04</b>	<b>3.50E-04</b>	<b>5.00E-04</b>	<b>6.50E-04</b>	<b>6.50E-04</b>	<b>6.50E-04</b>
Status	PASS	PASS	PASS	PASS	PASS	PASS	PASS

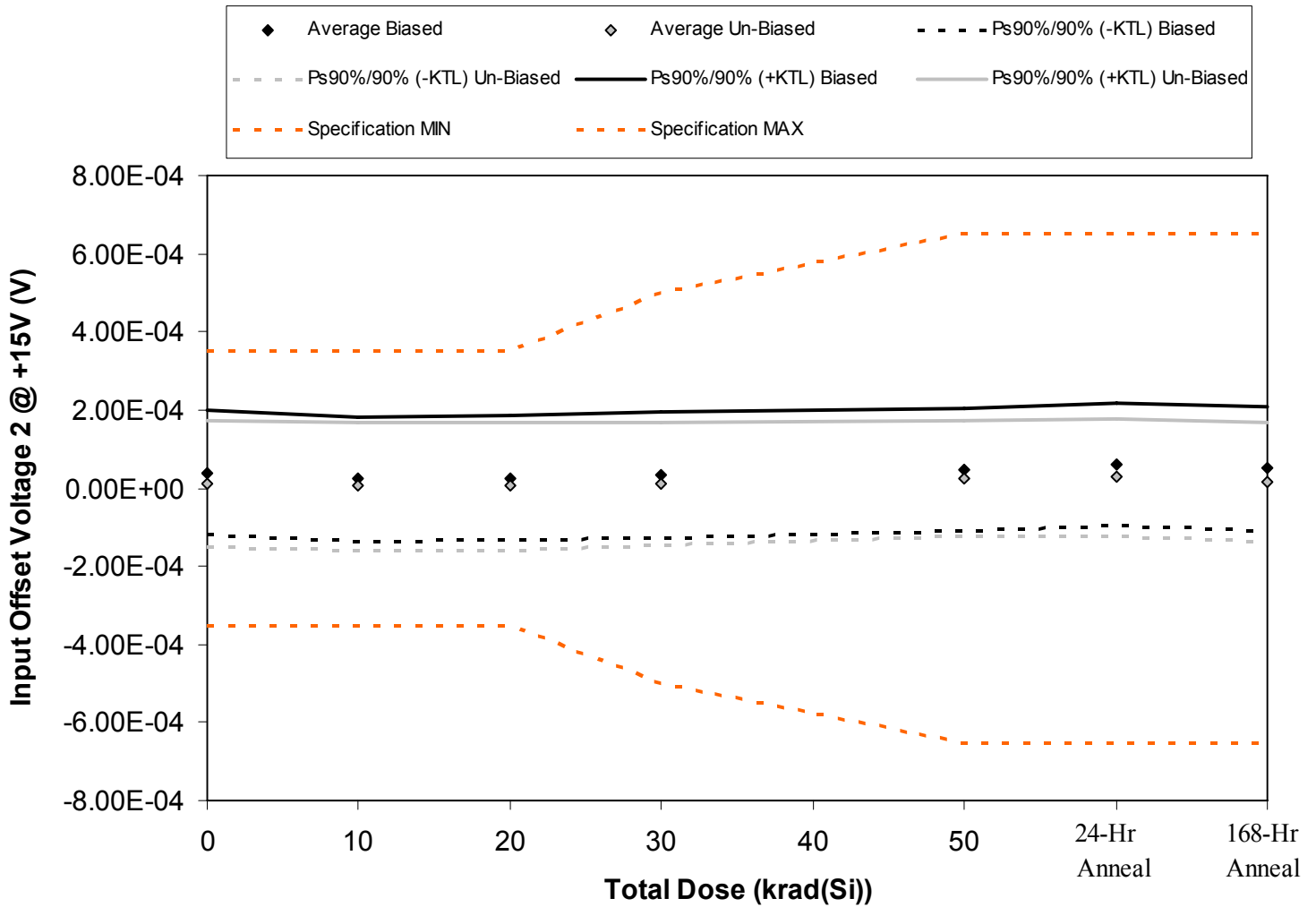

Figure 5.36. Plot of Input Offset Voltage 2 @ +15V (V) versus total dose. The solid diamonds are the average of the measured data points for the samples irradiated under electrical bias while the shaded diamonds are the average of the measured data points for the samples irradiated with all pins tied to ground. The black lines (solid and/or dashed) are the average of the data points after application of the KTL statistics on the samples irradiated under electrical bias while the gray lines (solid and/or dashed) are the average of the data points after application of the KTL statistics on the samples irradiated in the unbiased condition. The red dotted line(s) are the pre- and/or post-irradiation minimum and/or maximum specification value as defined in the datasheet and/or test plan.



Table 5.36. Raw data for Input Offset Voltage 2 @ +15V (V) versus total dose, including the statistical analysis, specification and the status of the testing (pass/fail).

Input Offset Voltage 2 @ +15V (V)	Total Dose (krad(Si))					24 hr Anneal	168 hr Anneal
	0	10	20	30	50		
Device							
255	-5.04E-05	-6.98E-05	-6.47E-05	-6.09E-05	-4.13E-05	-2.98E-05	-4.41E-05
258	1.04E-04	8.62E-05	8.63E-05	9.47E-05	1.09E-04	1.20E-04	1.08E-04
309	2.69E-05	9.06E-06	1.05E-05	1.63E-05	3.00E-05	4.89E-05	3.73E-05
359	6.88E-05	5.29E-05	5.97E-05	6.12E-05	7.33E-05	8.68E-05	6.80E-05
360	5.07E-05	3.42E-05	4.25E-05	4.86E-05	6.61E-05	7.58E-05	7.99E-05
416	-1.61E-05	-2.62E-05	-2.55E-05	-1.85E-05	-2.57E-07	2.03E-06	-1.63E-05
472	8.21E-05	7.38E-05	7.21E-05	7.58E-05	8.70E-05	8.94E-05	7.90E-05
473	4.18E-05	3.51E-05	3.21E-05	3.74E-05	5.03E-05	5.60E-05	3.57E-05
526	2.52E-05	2.49E-05	2.61E-05	3.17E-05	4.14E-05	4.86E-05	3.81E-05
529	-7.16E-05	-7.97E-05	-8.21E-05	-7.05E-05	-5.56E-05	-5.18E-05	-6.39E-05
530	-5.75E-05	-5.72E-05	-5.91E-05	-5.64E-05	-5.69E-05	-5.54E-05	-5.81E-05
561	7.78E-05	8.26E-05	8.00E-05	7.97E-05	8.13E-05	8.25E-05	8.04E-05
<b>Biased Statistics</b>							
Average Biased	4.01E-05	2.25E-05	2.69E-05	3.20E-05	4.74E-05	6.03E-05	4.99E-05
Std Dev Biased	5.79E-05	5.87E-05	5.81E-05	5.90E-05	5.70E-05	5.65E-05	5.84E-05
Ps90%/90% (+KTL) Biased	1.99E-04	1.84E-04	1.86E-04	1.94E-04	2.04E-04	2.15E-04	2.10E-04
Ps90%/90% (-KTL) Biased	-1.19E-04	-1.39E-04	-1.33E-04	-1.30E-04	-1.09E-04	-9.46E-05	-1.10E-04
<b>Un-Biased Statistics</b>							
Average Un-Biased	1.23E-05	5.58E-06	4.53E-06	1.12E-05	2.46E-05	2.89E-05	1.45E-05
Std Dev Un-Biased	5.86E-05	5.95E-05	5.95E-05	5.67E-05	5.45E-05	5.48E-05	5.54E-05
Ps90%/90% (+KTL) Un-Biased	1.73E-04	1.69E-04	1.68E-04	1.67E-04	1.74E-04	1.79E-04	1.66E-04
Ps90%/90% (-KTL) Un-Biased	-1.48E-04	-1.58E-04	-1.59E-04	-1.44E-04	-1.25E-04	-1.21E-04	-1.37E-04
<b>Specification MIN</b>	<b>-3.50E-04</b>	<b>-3.50E-04</b>	<b>-3.50E-04</b>	<b>-5.00E-04</b>	<b>-6.50E-04</b>	<b>-6.50E-04</b>	<b>-6.50E-04</b>
Status	PASS	PASS	PASS	PASS	PASS	PASS	PASS
<b>Specification MAX</b>	<b>3.50E-04</b>	<b>3.50E-04</b>	<b>3.50E-04</b>	<b>5.00E-04</b>	<b>6.50E-04</b>	<b>6.50E-04</b>	<b>6.50E-04</b>
Status	PASS	PASS	PASS	PASS	PASS	PASS	PASS

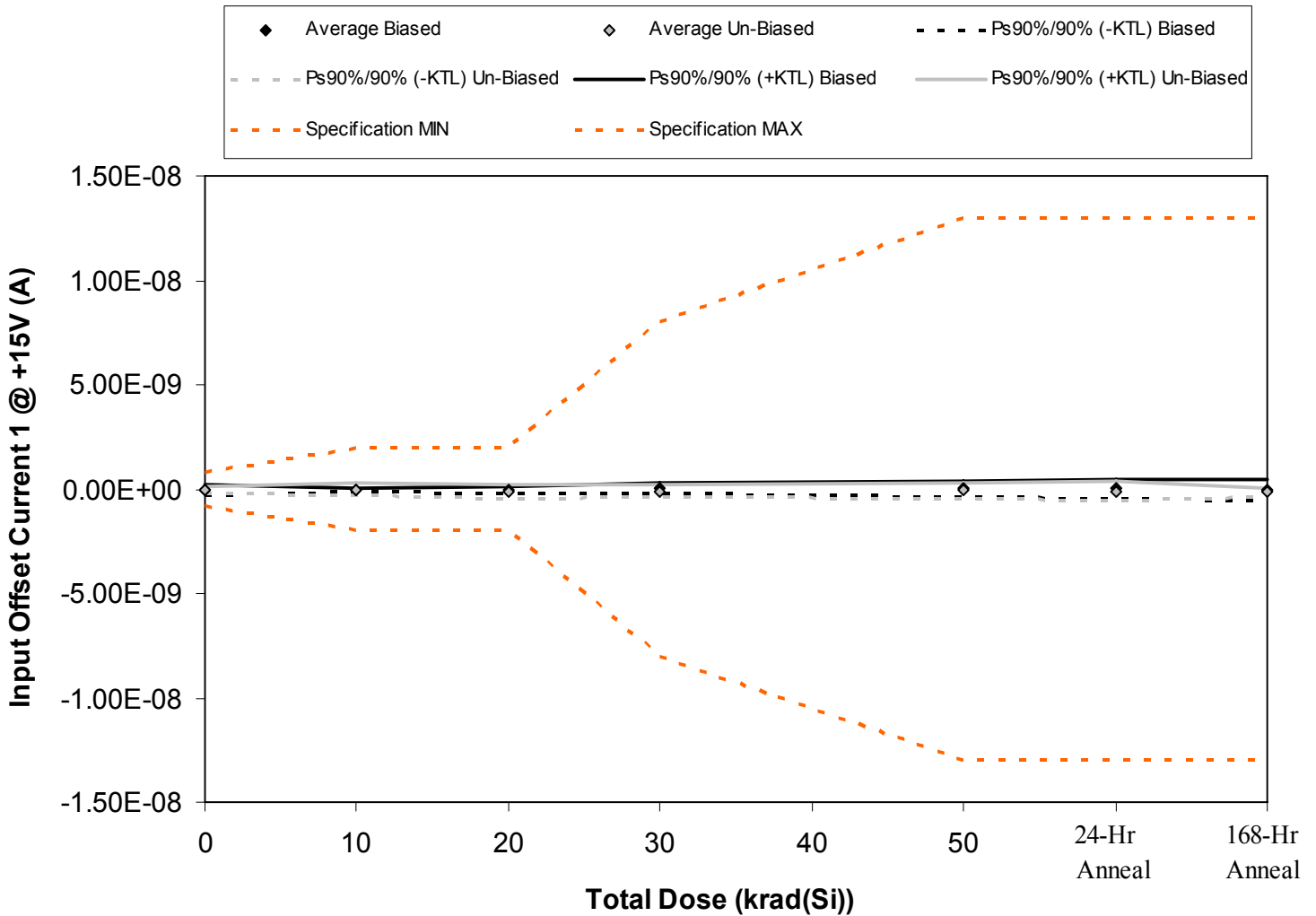

Figure 5.37. Plot of Input Offset Current 1 @ +15V (A) versus total dose. The solid diamonds are the average of the measured data points for the samples irradiated under electrical bias while the shaded diamonds are the average of the measured data points for the samples irradiated with all pins tied to ground. The black lines (solid and/or dashed) are the average of the data points after application of the KTL statistics on the samples irradiated under electrical bias while the gray lines (solid and/or dashed) are the average of the data points after application of the KTL statistics on the samples irradiated in the unbiased condition. The red dotted line(s) are the pre- and/or post-irradiation minimum and/or maximum specification value as defined in the datasheet and/or test plan.





Table 5.37. Raw data for Input Offset Current 1 @ +15V (A) versus total dose, including the statistical analysis, specification and the status of the testing (pass/fail).

Input Offset Current 1 @ +15V (A)	Total Dose (krad(Si))					24 hr Anneal	168 hr Anneal
	0	10	20	30	50		
Device							
255	8.00E-11	0.00E+00	-5.00E-11	0.00E+00	7.00E-11	1.00E-10	-9.00E-11
258	-6.00E-11	-2.00E-11	0.00E+00	6.00E-11	5.00E-11	7.00E-11	1.20E-10
309	-1.60E-10	-3.00E-11	-6.00E-11	-1.40E-10	-2.20E-10	-3.00E-10	-3.20E-10
359	-1.00E-11	-8.00E-11	-3.00E-11	5.00E-11	1.00E-10	5.00E-11	1.50E-10
360	-6.00E-11	-4.00E-11	9.00E-11	1.00E-10	1.20E-10	9.00E-11	1.00E-11
416	2.00E-11	4.00E-11	-8.00E-11	3.00E-11	2.00E-11	6.00E-11	-1.20E-10
472	-8.00E-11	1.30E-10	8.00E-11	2.00E-11	6.00E-11	8.00E-11	-2.40E-10
473	-2.00E-11	-1.00E-11	-1.90E-10	-1.70E-10	-3.20E-10	-2.60E-10	-2.00E-11
526	-4.00E-11	-1.50E-10	-1.10E-10	-1.60E-10	-4.00E-11	-2.50E-10	-1.80E-10
529	-1.00E-10	-2.00E-11	-2.40E-10	-1.60E-10	-1.20E-10	-1.40E-10	-1.80E-10
530	-1.80E-10	-1.40E-10	-6.00E-11	-5.00E-11	-1.50E-10	-9.00E-11	-1.60E-10
561	-2.00E-11	-3.00E-11	2.00E-11	-4.00E-11	1.00E-11	0.00E+00	-1.00E-11
<b>Biased Statistics</b>							
Average Biased	-4.20E-11	-3.40E-11	-1.00E-11	1.40E-11	2.40E-11	2.00E-12	-2.60E-11
Std Dev Biased	8.73E-11	2.97E-11	6.04E-11	9.32E-11	1.39E-10	1.70E-10	1.90E-10
Ps90%/90% (+KTL) Biased	1.97E-10	4.73E-11	1.56E-10	2.69E-10	4.05E-10	4.68E-10	4.94E-10
Ps90%/90% (-KTL) Biased	-2.81E-10	-1.15E-10	-1.76E-10	-2.41E-10	-3.57E-10	-4.64E-10	-5.46E-10
<b>Un-Biased Statistics</b>							
Average Un-Biased	-4.40E-11	-2.00E-12	-1.08E-10	-8.80E-11	-8.00E-11	-1.02E-10	-1.48E-10
Std Dev Un-Biased	4.77E-11	1.02E-10	1.23E-10	1.03E-10	1.50E-10	1.64E-10	8.32E-11
Ps90%/90% (+KTL) Un-Biased	8.69E-11	2.77E-10	2.29E-10	1.95E-10	3.32E-10	3.48E-10	8.01E-11
Ps90%/90% (-KTL) Un-Biased	-1.75E-10	-2.81E-10	-4.45E-10	-3.71E-10	-4.92E-10	-5.52E-10	-3.76E-10
<b>Specification MIN</b>	<b>-8.00E-10</b>	<b>-2.00E-09</b>	<b>-2.00E-09</b>	<b>-8.00E-09</b>	<b>-1.30E-08</b>	<b>-1.30E-08</b>	<b>-1.30E-08</b>
Status	PASS	PASS	PASS	PASS	PASS	PASS	PASS
<b>Specification MAX</b>	<b>8.00E-10</b>	<b>2.00E-09</b>	<b>2.00E-09</b>	<b>8.00E-09</b>	<b>1.30E-08</b>	<b>1.30E-08</b>	<b>1.30E-08</b>
Status	PASS	PASS	PASS	PASS	PASS	PASS	PASS

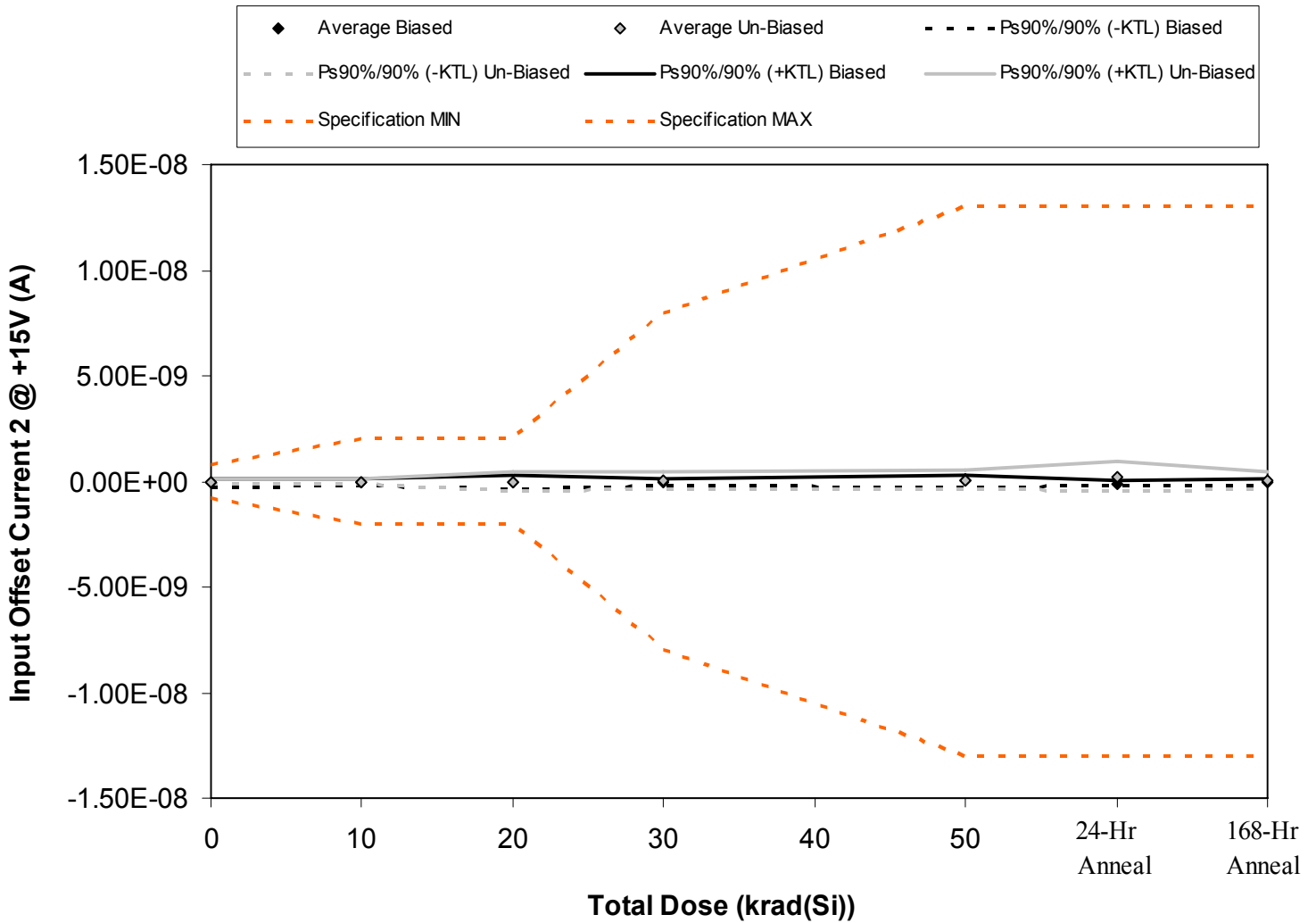

Figure 5.38. Plot of Input Offset Current 2 @ +15V (A) versus total dose. The solid diamonds are the average of the measured data points for the samples irradiated under electrical bias while the shaded diamonds are the average of the measured data points for the samples irradiated with all pins tied to ground. The black lines (solid and/or dashed) are the average of the data points after application of the KTL statistics on the samples irradiated under electrical bias while the gray lines (solid and/or dashed) are the average of the data points after application of the KTL statistics on the samples irradiated in the unbiased condition. The red dotted line(s) are the pre- and/or post-irradiation minimum and/or maximum specification value as defined in the datasheet and/or test plan.



Table 5.38. Raw data for Input Offset Current 2 @ +15V (A) versus total dose, including the statistical analysis, specification and the status of the testing (pass/fail).

Input Offset Current 2 @ +15V (A)	Total Dose (krad(Si))					24 hr Anneal	168 hr Anneal
	0	10	20	30	50		
Device							
255	-1.20E-10	1.00E-11	8.00E-11	0.00E+00	6.00E-11	-9.00E-11	-1.20E-10
258	-1.50E-10	-9.00E-11	1.00E-11	0.00E+00	1.10E-10	-1.80E-10	1.00E-11
309	1.00E-11	-1.30E-10	-2.40E-10	-1.30E-10	-9.00E-11	-9.00E-11	-3.00E-11
359	-1.60E-10	-9.00E-11	-5.00E-11	-6.00E-11	-1.00E-10	-3.00E-11	-2.00E-11
360	2.00E-11	0.00E+00	2.00E-11	2.00E-11	8.00E-11	-5.00E-11	-2.00E-11
416	0.00E+00	0.00E+00	1.30E-10	6.00E-11	1.80E-10	2.80E-10	0.00E+00
472	0.00E+00	-4.00E-11	-1.70E-10	-1.40E-10	-7.00E-11	-1.00E-11	5.00E-11
473	-2.00E-11	-5.00E-11	4.00E-11	8.00E-11	3.00E-11	2.20E-10	-1.10E-10
526	-7.00E-11	2.00E-11	-2.00E-10	-1.00E-10	-1.20E-10	8.00E-11	-5.00E-11
529	6.00E-11	7.00E-11	2.00E-10	2.50E-10	2.80E-10	6.40E-10	2.90E-10
530	-1.00E-11	3.00E-11	-7.00E-11	-1.10E-10	-5.00E-11	0.00E+00	-4.00E-11
561	-1.40E-10	-1.00E-10	-2.00E-10	-1.20E-10	-2.50E-10	-1.30E-10	-1.60E-10
<b>Biased Statistics</b>							
Average Biased	-8.00E-11	-6.00E-11	-3.60E-11	-3.40E-11	1.20E-11	-8.80E-11	-3.60E-11
Std Dev Biased	8.80E-11	6.16E-11	1.23E-10	6.15E-11	9.93E-11	5.76E-11	4.93E-11
Ps90%/90% (+KTL) Biased	1.61E-10	1.09E-10	3.01E-10	1.35E-10	2.84E-10	7.00E-11	9.92E-11
Ps90%/90% (-KTL) Biased	-3.21E-10	-2.29E-10	-3.73E-10	-2.03E-10	-2.60E-10	-2.46E-10	-1.71E-10
<b>Un-Biased Statistics</b>							
Average Un-Biased	-6.00E-12	0.00E+00	-5.17E-27	3.00E-11	6.00E-11	2.42E-10	3.60E-11
Std Dev Un-Biased	4.67E-11	4.85E-11	1.78E-10	1.56E-10	1.68E-10	2.50E-10	1.54E-10
Ps90%/90% (+KTL) Un-Biased	1.22E-10	1.33E-10	4.89E-10	4.58E-10	5.21E-10	9.28E-10	4.58E-10
Ps90%/90% (-KTL) Un-Biased	-1.34E-10	-1.33E-10	-4.89E-10	-3.98E-10	-4.01E-10	-4.44E-10	-3.86E-10
<b>Specification MIN</b>	<b>-8.00E-10</b>	<b>-2.00E-09</b>	<b>-2.00E-09</b>	<b>-8.00E-09</b>	<b>-1.30E-08</b>	<b>-1.30E-08</b>	<b>-1.30E-08</b>
Status	PASS	PASS	PASS	PASS	PASS	PASS	PASS
<b>Specification MAX</b>	<b>8.00E-10</b>	<b>2.00E-09</b>	<b>2.00E-09</b>	<b>8.00E-09</b>	<b>1.30E-08</b>	<b>1.30E-08</b>	<b>1.30E-08</b>
Status	PASS	PASS	PASS	PASS	PASS	PASS	PASS

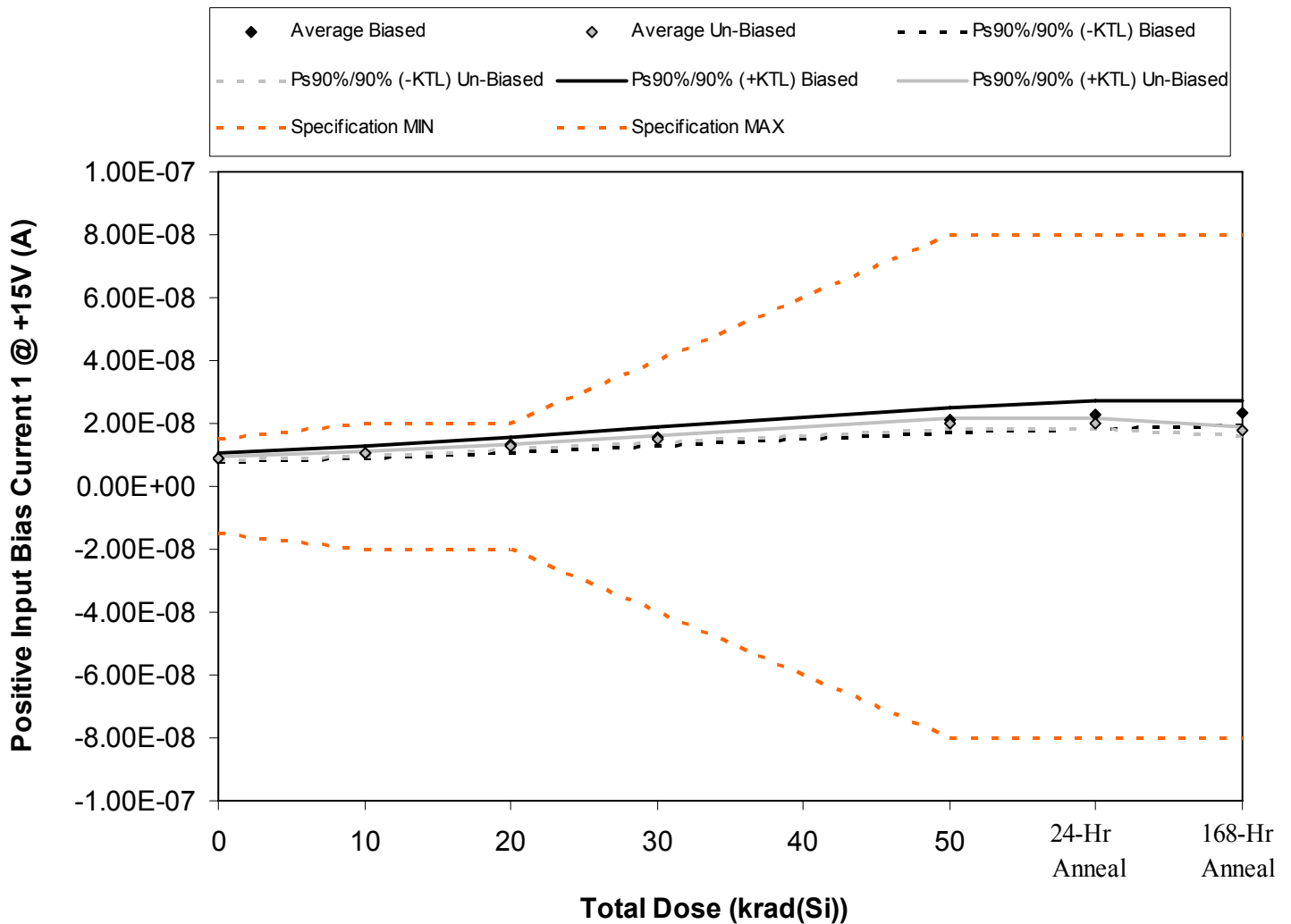

Figure 5.39. Plot of Positive Input Bias Current 1 @ +15V (A) versus total dose. The solid diamonds are the average of the measured data points for the samples irradiated under electrical bias while the shaded diamonds are the average of the measured data points for the samples irradiated with all pins tied to ground. The black lines (solid and/or dashed) are the average of the data points after application of the KTL statistics on the samples irradiated under electrical bias while the gray lines (solid and/or dashed) are the average of the data points after application of the KTL statistics on the samples irradiated in the unbiased condition. The red dotted line(s) are the pre- and/or post-irradiation minimum and/or maximum specification value as defined in the datasheet and/or test plan.



Table 5.39. Raw data for Positive Input Bias Current 1 @ +15V (A) versus total dose, including the statistical analysis, specification and the status of the testing (pass/fail).

Positive Input Bias Current 1 @ +15V (A)	Total Dose (krad(Si))					24 hr Anneal	168 hr Anneal
	0	10	20	30	50		
Device							
255	8.25E-09	9.86E-09	1.19E-08	1.43E-08	1.97E-08	2.12E-08	2.19E-08
258	9.58E-09	1.14E-08	1.39E-08	1.66E-08	2.26E-08	2.44E-08	2.50E-08
309	9.28E-09	1.09E-08	1.35E-08	1.60E-08	2.14E-08	2.30E-08	2.37E-08
359	9.38E-09	1.13E-08	1.39E-08	1.69E-08	2.24E-08	2.40E-08	2.44E-08
360	8.69E-09	1.02E-08	1.23E-08	1.48E-08	1.97E-08	2.08E-08	2.17E-08
416	9.23E-09	1.08E-08	1.30E-08	1.53E-08	2.01E-08	2.00E-08	1.78E-08
472	8.59E-09	1.02E-08	1.24E-08	1.48E-08	1.94E-08	1.92E-08	1.70E-08
473	8.77E-09	1.03E-08	1.27E-08	1.51E-08	2.01E-08	2.00E-08	1.75E-08
526	9.02E-09	1.08E-08	1.30E-08	1.55E-08	2.09E-08	2.07E-08	1.81E-08
529	8.72E-09	1.03E-08	1.24E-08	1.47E-08	1.98E-08	1.96E-08	1.72E-08
530	8.95E-09	8.97E-09	8.90E-09	8.91E-09	9.01E-09	8.96E-09	8.98E-09
561	8.65E-09	8.67E-09	8.65E-09	8.68E-09	8.64E-09	8.62E-09	8.62E-09
<b>Biased Statistics</b>							
Average Biased	9.04E-09	1.07E-08	1.31E-08	1.57E-08	2.12E-08	2.27E-08	2.34E-08
Std Dev Biased	5.50E-10	6.62E-10	9.21E-10	1.13E-09	1.44E-09	1.63E-09	1.47E-09
Ps90%/90% (+KTL) Biased	1.05E-08	1.25E-08	1.56E-08	1.88E-08	2.51E-08	2.71E-08	2.74E-08
Ps90%/90% (-KTL) Biased	7.53E-09	8.92E-09	1.06E-08	1.26E-08	1.72E-08	1.82E-08	1.93E-08
<b>Un-Biased Statistics</b>							
Average Un-Biased	8.87E-09	1.04E-08	1.27E-08	1.51E-08	2.01E-08	1.99E-08	1.75E-08
Std Dev Un-Biased	2.56E-10	3.02E-10	2.94E-10	3.53E-10	5.60E-10	5.52E-10	4.36E-10
Ps90%/90% (+KTL) Un-Biased	9.57E-09	1.13E-08	1.35E-08	1.60E-08	2.16E-08	2.14E-08	1.87E-08
Ps90%/90% (-KTL) Un-Biased	8.16E-09	9.62E-09	1.19E-08	1.41E-08	1.85E-08	1.84E-08	1.63E-08
<b>Specification MIN</b>	<b>-1.50E-08</b>	<b>-2.00E-08</b>	<b>-2.00E-08</b>	<b>-4.00E-08</b>	<b>-8.00E-08</b>	<b>-8.00E-08</b>	<b>-8.00E-08</b>
Status	PASS	PASS	PASS	PASS	PASS	PASS	PASS
<b>Specification MAX</b>	<b>1.50E-08</b>	<b>2.00E-08</b>	<b>2.00E-08</b>	<b>4.00E-08</b>	<b>8.00E-08</b>	<b>8.00E-08</b>	<b>8.00E-08</b>
Status	PASS	PASS	PASS	PASS	PASS	PASS	PASS

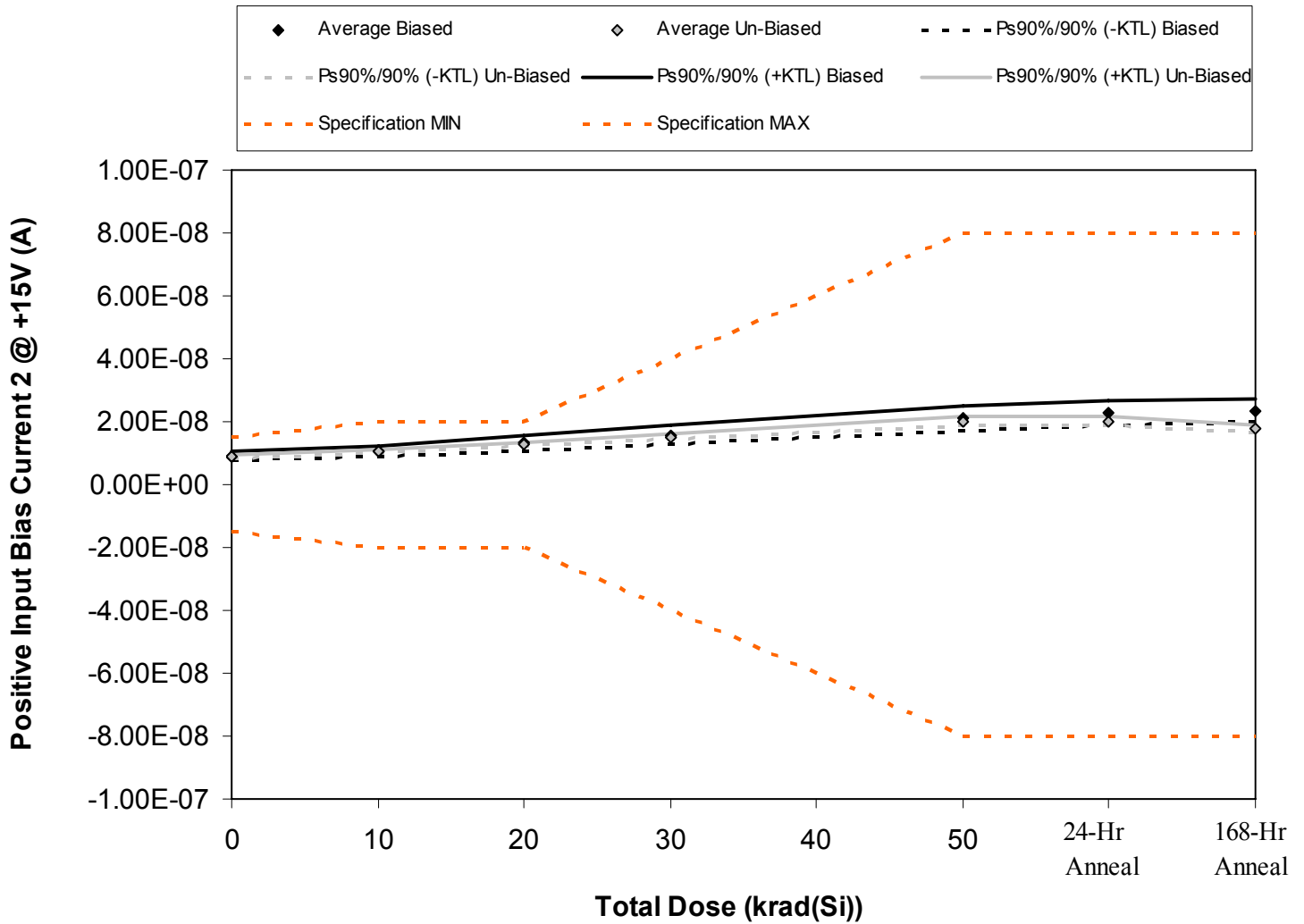

Figure 5.40. Plot of Positive Input Bias Current 2 @ +15V (A) versus total dose. The solid diamonds are the average of the measured data points for the samples irradiated under electrical bias while the shaded diamonds are the average of the measured data points for the samples irradiated with all pins tied to ground. The black lines (solid and/or dashed) are the average of the data points after application of the KTL statistics on the samples irradiated under electrical bias while the gray lines (solid and/or dashed) are the average of the data points after application of the KTL statistics on the samples irradiated in the unbiased condition. The red dotted line(s) are the pre- and/or post-irradiation minimum and/or maximum specification value as defined in the datasheet and/or test plan.



Table 5.40. Raw data for Positive Input Bias Current 2 @ +15V (A) versus total dose, including the statistical analysis, specification and the status of the testing (pass/fail).

Positive Input Bias Current 2 @ +15V (A)	Total Dose (krad(Si))					24 hr Anneal	168 hr Anneal
	0	10	20	30	50		
Device							
255	8.34E-09	9.82E-09	1.19E-08	1.44E-08	1.96E-08	2.12E-08	2.20E-08
258	9.54E-09	1.12E-08	1.39E-08	1.68E-08	2.28E-08	2.44E-08	2.50E-08
309	9.26E-09	1.09E-08	1.33E-08	1.61E-08	2.13E-08	2.29E-08	2.38E-08
359	9.32E-09	1.12E-08	1.39E-08	1.67E-08	2.22E-08	2.36E-08	2.41E-08
360	8.95E-09	1.04E-08	1.26E-08	1.51E-08	1.98E-08	2.11E-08	2.21E-08
416	9.20E-09	1.07E-08	1.30E-08	1.54E-08	2.01E-08	2.01E-08	1.77E-08
472	8.77E-09	1.03E-08	1.24E-08	1.48E-08	1.95E-08	1.96E-08	1.71E-08
473	8.70E-09	1.03E-08	1.28E-08	1.53E-08	2.03E-08	2.04E-08	1.77E-08
526	8.90E-09	1.07E-08	1.28E-08	1.55E-08	2.08E-08	2.08E-08	1.82E-08
529	8.75E-09	1.04E-08	1.27E-08	1.52E-08	2.02E-08	2.04E-08	1.77E-08
530	8.97E-09	9.07E-09	8.97E-09	8.92E-09	8.99E-09	9.03E-09	9.00E-09
561	8.69E-09	8.68E-09	8.64E-09	8.75E-09	8.64E-09	8.66E-09	8.70E-09
<b>Biased Statistics</b>							
Average Biased	9.08E-09	1.07E-08	1.31E-08	1.58E-08	2.11E-08	2.26E-08	2.34E-08
Std Dev Biased	4.65E-10	5.89E-10	8.44E-10	1.05E-09	1.42E-09	1.45E-09	1.30E-09
Ps90%/90% (+KTL) Biased	1.04E-08	1.23E-08	1.54E-08	1.87E-08	2.50E-08	2.66E-08	2.70E-08
Ps90%/90% (-KTL) Biased	7.81E-09	9.09E-09	1.08E-08	1.29E-08	1.72E-08	1.86E-08	1.98E-08
<b>Un-Biased Statistics</b>							
Average Un-Biased	8.86E-09	1.05E-08	1.27E-08	1.52E-08	2.02E-08	2.02E-08	1.77E-08
Std Dev Un-Biased	2.02E-10	2.12E-10	2.48E-10	2.70E-10	4.88E-10	4.66E-10	3.86E-10
Ps90%/90% (+KTL) Un-Biased	9.42E-09	1.11E-08	1.34E-08	1.60E-08	2.15E-08	2.15E-08	1.87E-08
Ps90%/90% (-KTL) Un-Biased	8.31E-09	9.90E-09	1.21E-08	1.45E-08	1.88E-08	1.90E-08	1.66E-08
<b>Specification MIN</b>	<b>-1.50E-08</b>	<b>-2.00E-08</b>	<b>-2.00E-08</b>	<b>-4.00E-08</b>	<b>-8.00E-08</b>	<b>-8.00E-08</b>	<b>-8.00E-08</b>
Status	PASS	PASS	PASS	PASS	PASS	PASS	PASS
<b>Specification MAX</b>	<b>1.50E-08</b>	<b>2.00E-08</b>	<b>2.00E-08</b>	<b>4.00E-08</b>	<b>8.00E-08</b>	<b>8.00E-08</b>	<b>8.00E-08</b>
Status	PASS	PASS	PASS	PASS	PASS	PASS	PASS

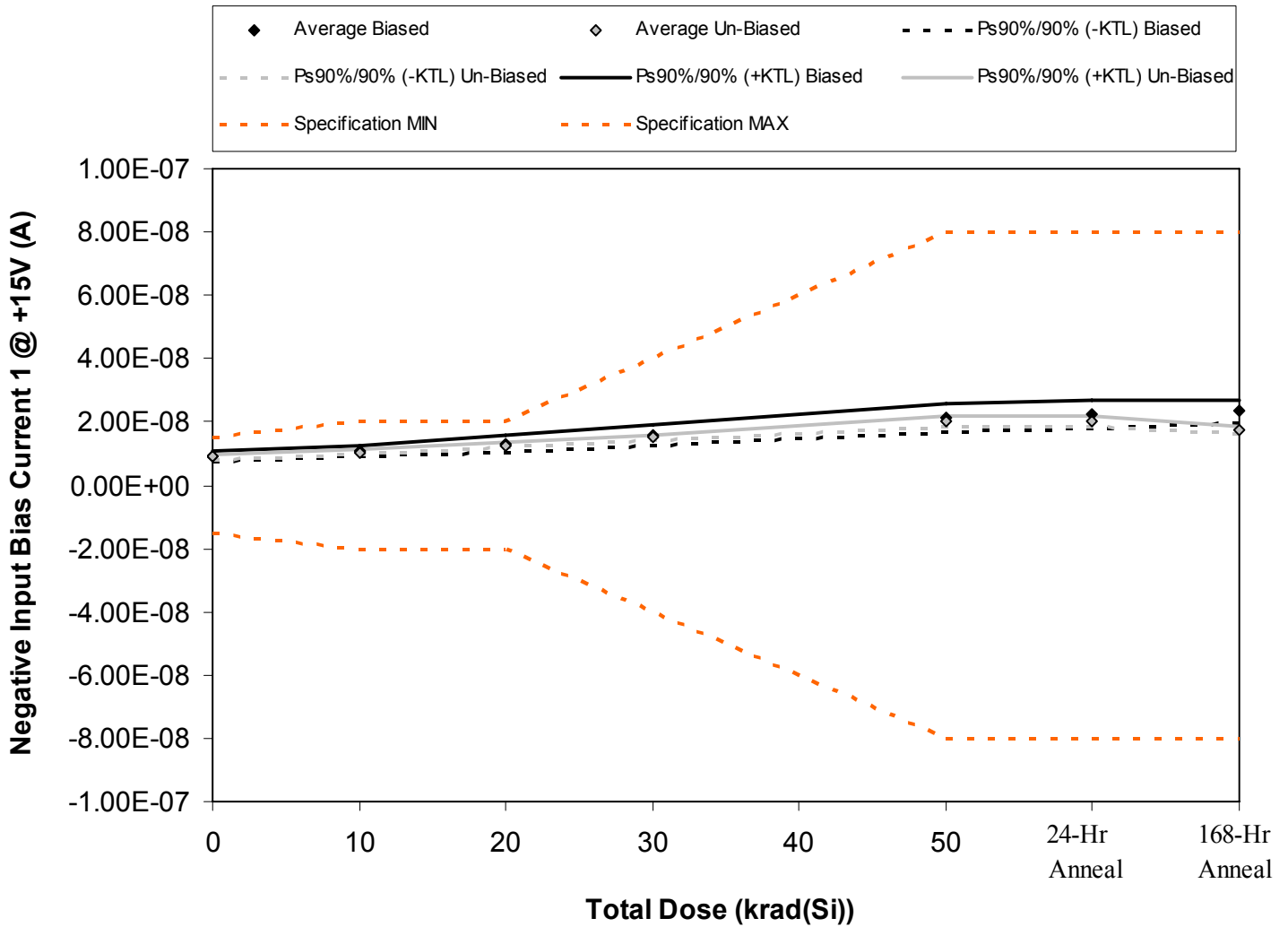

Figure 5.41. Plot of Negative Input Bias Current 1 @ +15V (A) versus total dose. The solid diamonds are the average of the measured data points for the samples irradiated under electrical bias while the shaded diamonds are the average of the measured data points for the samples irradiated with all pins tied to ground. The black lines (solid and/or dashed) are the average of the data points after application of the KTL statistics on the samples irradiated under electrical bias while the gray lines (solid and/or dashed) are the average of the data points after application of the KTL statistics on the samples irradiated in the unbiased condition. The red dotted line(s) are the pre- and/or post-irradiation minimum and/or maximum specification value as defined in the datasheet and/or test plan.





Table 5.41. Raw data for Negative Input Bias Current 1 @ +15V (A) versus total dose, including the statistical analysis, specification and the status of the testing (pass/fail).

Negative Input Bias Current 1 @ +15V (A)	Total Dose (krad(Si))					24 hr Anneal	168 hr Anneal
	0	10	20	30	50		
Device							
255	8.41E-09	9.84E-09	1.20E-08	1.45E-08	1.97E-08	2.12E-08	2.20E-08
258	9.60E-09	1.14E-08	1.39E-08	1.66E-08	2.27E-08	2.44E-08	2.48E-08
309	9.35E-09	1.10E-08	1.36E-08	1.63E-08	2.19E-08	2.32E-08	2.40E-08
359	9.53E-09	1.12E-08	1.40E-08	1.69E-08	2.25E-08	2.40E-08	2.42E-08
360	8.61E-09	1.03E-08	1.22E-08	1.46E-08	1.94E-08	2.08E-08	2.18E-08
416	9.18E-09	1.08E-08	1.29E-08	1.52E-08	2.00E-08	2.01E-08	1.79E-08
472	8.83E-09	1.01E-08	1.23E-08	1.46E-08	1.93E-08	1.93E-08	1.72E-08
473	8.80E-09	1.04E-08	1.27E-08	1.52E-08	2.04E-08	2.04E-08	1.77E-08
526	8.97E-09	1.10E-08	1.32E-08	1.56E-08	2.09E-08	2.09E-08	1.81E-08
529	8.61E-09	1.04E-08	1.25E-08	1.49E-08	2.01E-08	1.98E-08	1.73E-08
530	9.03E-09	9.01E-09	9.03E-09	9.12E-09	9.01E-09	9.02E-09	9.01E-09
561	8.65E-09	8.71E-09	8.74E-09	8.60E-09	8.63E-09	8.73E-09	8.73E-09
<b>Biased Statistics</b>							
Average Biased	9.10E-09	1.08E-08	1.31E-08	1.58E-08	2.12E-08	2.27E-08	2.34E-08
Std Dev Biased	5.51E-10	6.53E-10	9.59E-10	1.15E-09	1.57E-09	1.62E-09	1.36E-09
Ps90%/90% (+KTL) Biased	1.06E-08	1.25E-08	1.58E-08	1.89E-08	2.56E-08	2.71E-08	2.71E-08
Ps90%/90% (-KTL) Biased	7.59E-09	8.97E-09	1.05E-08	1.26E-08	1.69E-08	1.82E-08	1.96E-08
<b>Un-Biased Statistics</b>							
Average Un-Biased	8.88E-09	1.05E-08	1.27E-08	1.51E-08	2.01E-08	2.01E-08	1.76E-08
Std Dev Un-Biased	2.12E-10	3.43E-10	3.28E-10	3.48E-10	6.18E-10	6.19E-10	3.98E-10
Ps90%/90% (+KTL) Un-Biased	9.46E-09	1.15E-08	1.36E-08	1.61E-08	2.18E-08	2.18E-08	1.87E-08
Ps90%/90% (-KTL) Un-Biased	8.30E-09	9.58E-09	1.18E-08	1.42E-08	1.84E-08	1.84E-08	1.65E-08
<b>Specification MIN</b>	<b>-1.50E-08</b>	<b>-2.00E-08</b>	<b>-2.00E-08</b>	<b>-4.00E-08</b>	<b>-8.00E-08</b>	<b>-8.00E-08</b>	<b>-8.00E-08</b>
Status	PASS	PASS	PASS	PASS	PASS	PASS	PASS
<b>Specification MAX</b>	<b>1.50E-08</b>	<b>2.00E-08</b>	<b>2.00E-08</b>	<b>4.00E-08</b>	<b>8.00E-08</b>	<b>8.00E-08</b>	<b>8.00E-08</b>
Status	PASS	PASS	PASS	PASS	PASS	PASS	PASS

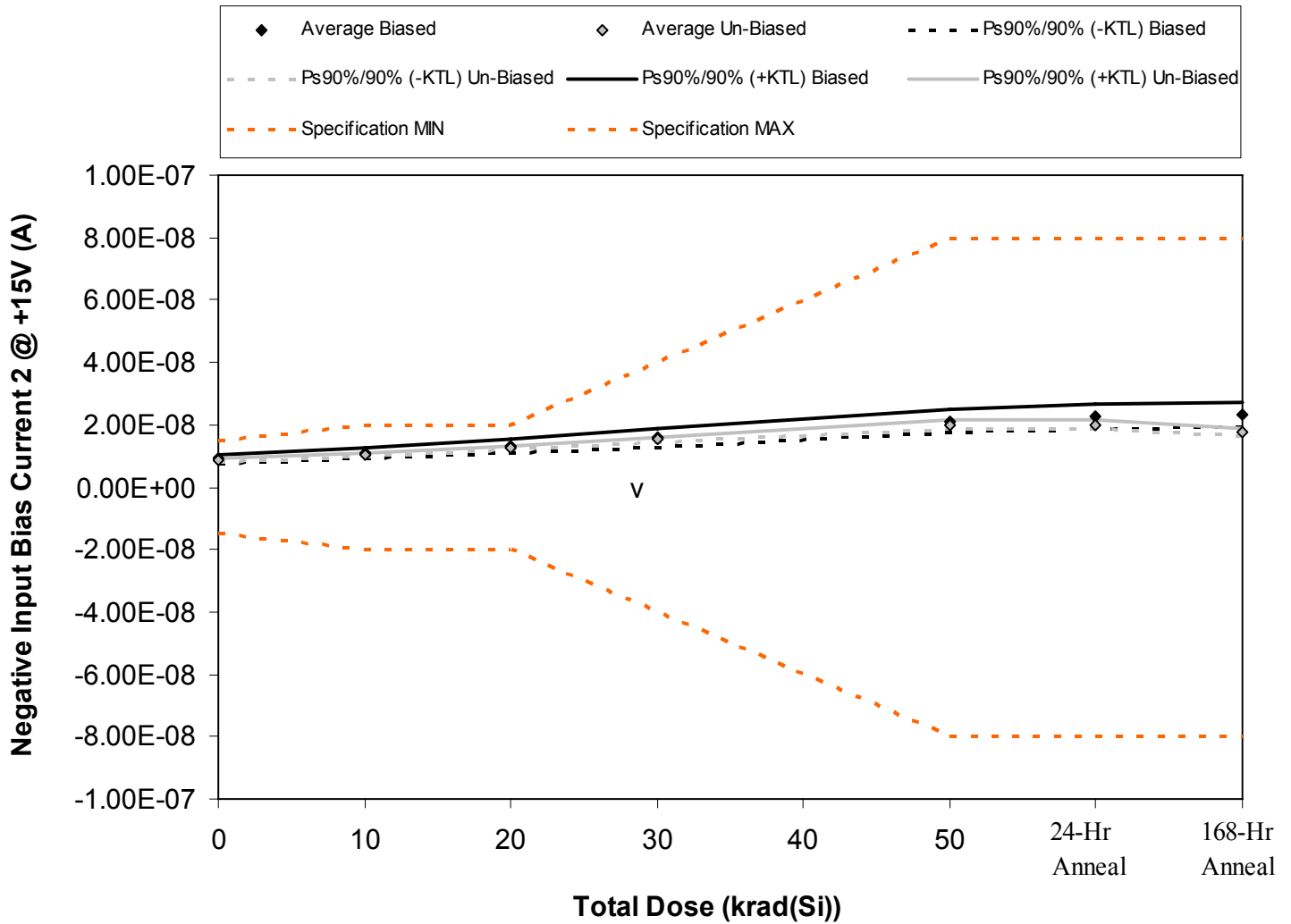

Figure 5.42. Plot of Negative Input Bias Current 2 @ +15V (A) versus total dose. The solid diamonds are the average of the measured data points for the samples irradiated under electrical bias while the shaded diamonds are the average of the measured data points for the samples irradiated with all pins tied to ground. The black lines (solid and/or dashed) are the average of the data points after application of the KTL statistics on the samples irradiated under electrical bias while the gray lines (solid and/or dashed) are the average of the data points after application of the KTL statistics on the samples irradiated in the unbiased condition. The red dotted line(s) are the pre- and/or post-irradiation minimum and/or maximum specification value as defined in the datasheet and/or test plan.



Table 5.42. Raw data for Negative Input Bias Current 2 @ +15V (A) versus total dose, including the statistical analysis, specification and the status of the testing (pass/fail).

Negative Input Bias Current 2 @ +15V (A)	Total Dose (krad(Si))					24 hr Anneal	168 hr Anneal
	0	10	20	30	50		
Device							
255	8.42E-09	9.87E-09	1.19E-08	1.43E-08	1.97E-08	2.12E-08	2.19E-08
258	9.74E-09	1.14E-08	1.39E-08	1.67E-08	2.27E-08	2.45E-08	2.51E-08
309	9.35E-09	1.11E-08	1.36E-08	1.61E-08	2.15E-08	2.30E-08	2.40E-08
359	9.48E-09	1.14E-08	1.39E-08	1.68E-08	2.23E-08	2.36E-08	2.42E-08
360	8.93E-09	1.04E-08	1.26E-08	1.51E-08	1.99E-08	2.11E-08	2.21E-08
416	9.19E-09	1.07E-08	1.29E-08	1.53E-08	2.00E-08	1.99E-08	1.79E-08
472	8.85E-09	1.04E-08	1.26E-08	1.48E-08	1.95E-08	1.95E-08	1.72E-08
473	8.83E-09	1.04E-08	1.28E-08	1.52E-08	2.03E-08	2.02E-08	1.78E-08
526	9.04E-09	1.07E-08	1.31E-08	1.55E-08	2.09E-08	2.08E-08	1.83E-08
529	8.71E-09	1.03E-08	1.26E-08	1.49E-08	1.98E-08	1.98E-08	1.75E-08
530	8.97E-09	9.08E-09	9.14E-09	9.03E-09	9.10E-09	9.16E-09	9.15E-09
561	8.93E-09	8.91E-09	8.87E-09	8.92E-09	8.95E-09	8.84E-09	8.84E-09
<b>Biased Statistics</b>							
Average Biased	9.18E-09	1.08E-08	1.32E-08	1.58E-08	2.12E-08	2.27E-08	2.35E-08
Std Dev Biased	5.18E-10	6.70E-10	8.97E-10	1.08E-09	1.38E-09	1.47E-09	1.41E-09
Ps90%/90% (+KTL) Biased	1.06E-08	1.27E-08	1.56E-08	1.88E-08	2.50E-08	2.67E-08	2.73E-08
Ps90%/90% (-KTL) Biased	7.76E-09	9.00E-09	1.07E-08	1.29E-08	1.74E-08	1.86E-08	1.96E-08
<b>Un-Biased Statistics</b>							
Average Un-Biased	8.92E-09	1.05E-08	1.28E-08	1.51E-08	2.01E-08	2.00E-08	1.77E-08
Std Dev Un-Biased	1.90E-10	1.79E-10	2.23E-10	3.01E-10	5.16E-10	5.14E-10	4.09E-10
Ps90%/90% (+KTL) Un-Biased	9.44E-09	1.10E-08	1.34E-08	1.60E-08	2.15E-08	2.15E-08	1.88E-08
Ps90%/90% (-KTL) Un-Biased	8.40E-09	1.00E-08	1.22E-08	1.43E-08	1.87E-08	1.86E-08	1.66E-08
<b>Specification MIN</b>	<b>-1.50E-08</b>	<b>-2.00E-08</b>	<b>-2.00E-08</b>	<b>-4.00E-08</b>	<b>-8.00E-08</b>	<b>-8.00E-08</b>	<b>-8.00E-08</b>
Status	PASS	PASS	PASS	PASS	PASS	PASS	PASS
<b>Specification MAX</b>	<b>1.50E-08</b>	<b>2.00E-08</b>	<b>2.00E-08</b>	<b>4.00E-08</b>	<b>8.00E-08</b>	<b>8.00E-08</b>	<b>8.00E-08</b>
Status	PASS	PASS	PASS	PASS	PASS	PASS	PASS

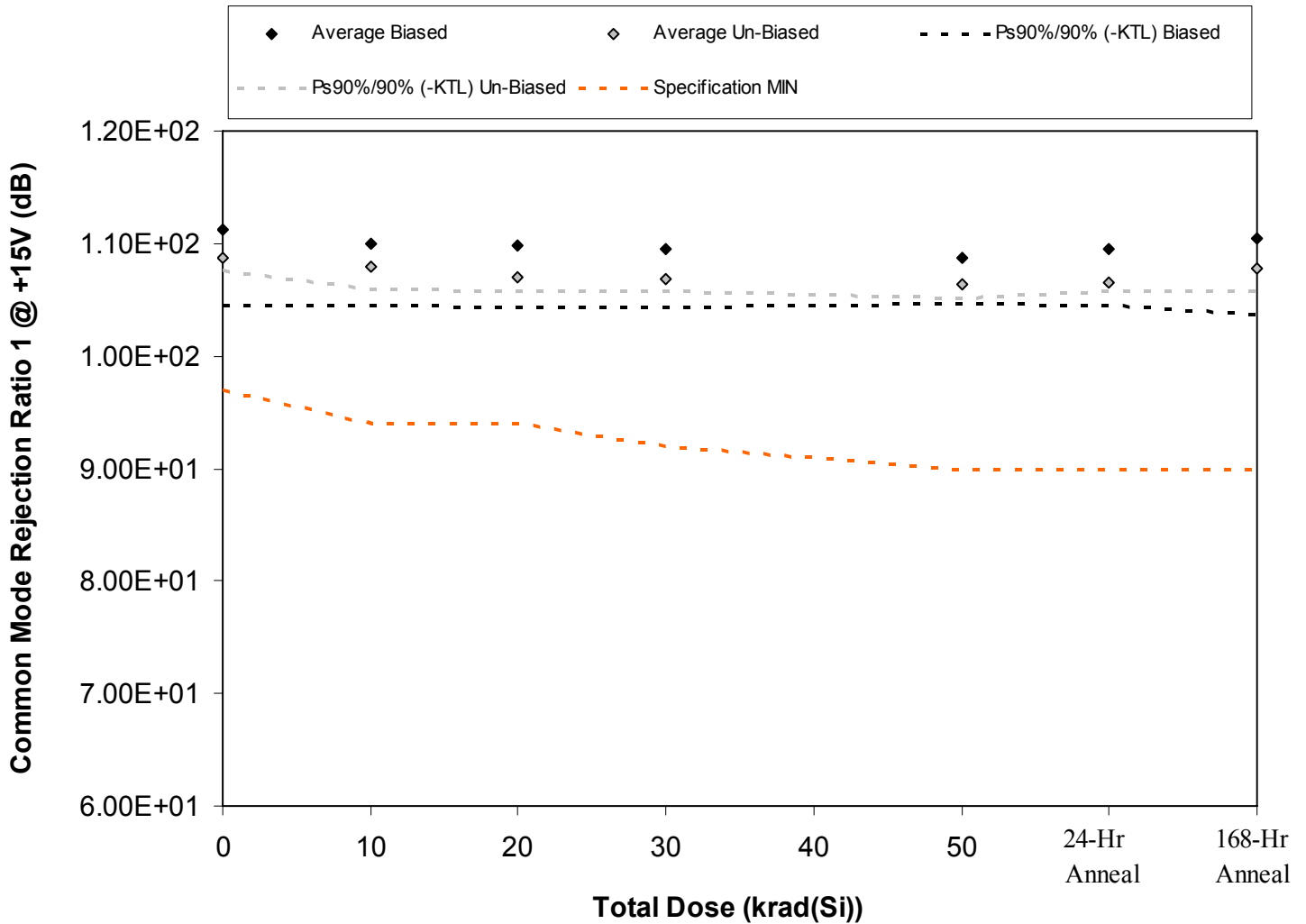

Figure 5.43. Plot of Common Mode Rejection Ratio 1 @ +15V (dB) versus total dose. The solid diamonds are the average of the measured data points for the samples irradiated under electrical bias while the shaded diamonds are the average of the measured data points for the samples irradiated with all pins tied to ground. The black lines (solid and/or dashed) are the average of the data points after application of the KTL statistics on the samples irradiated under electrical bias while the gray lines (solid and/or dashed) are the average of the data points after application of the KTL statistics on the samples irradiated in the unbiased condition. The red dotted line(s) are the pre- and/or post-irradiation minimum and/or maximum specification value as defined in the datasheet and/or test plan.



**TID Report**  
**10-004 100412 R1.0**

**Radiation Assured Devices**  
**5017 N. 30th Street**  
**Colorado Springs, CO 80919**  
**(719) 531-0800**

Table 5.43. Raw data for Common Mode Rejection Ratio 1 @ +15V (dB) versus total dose, including the statistical analysis, specification and the status of the testing (pass/fail).

Common Mode Rejection Ratio 1 @ +15V (dB)	Total Dose (krad(Si))					24 hr Anneal	168 hr Anneal
	0	10	20	30	50		
Device							
255	1.15E+02	1.13E+02	1.13E+02	1.12E+02	1.11E+02	1.12E+02	1.15E+02
258	1.09E+02	1.09E+02	1.09E+02	1.08E+02	1.07E+02	1.08E+02	1.09E+02
309	1.09E+02	1.08E+02	1.08E+02	1.08E+02	1.08E+02	1.08E+02	1.09E+02
359	1.12E+02	1.11E+02	1.11E+02	1.11E+02	1.10E+02	1.10E+02	1.10E+02
360	1.10E+02	1.09E+02	1.09E+02	1.08E+02	1.08E+02	1.08E+02	1.10E+02
416	1.09E+02	1.08E+02	1.07E+02	1.07E+02	1.07E+02	1.06E+02	1.08E+02
472	1.09E+02	1.08E+02	1.07E+02	1.07E+02	1.06E+02	1.06E+02	1.08E+02
473	1.08E+02	1.08E+02	1.07E+02	1.07E+02	1.06E+02	1.06E+02	1.07E+02
526	1.09E+02	1.09E+02	1.08E+02	1.08E+02	1.07E+02	1.07E+02	1.09E+02
529	1.08E+02	1.07E+02	1.07E+02	1.07E+02	1.06E+02	1.06E+02	1.07E+02
530	1.08E+02	1.08E+02	1.08E+02	1.08E+02	1.08E+02	1.08E+02	1.08E+02
561	1.10E+02	1.11E+02	1.10E+02	1.10E+02	1.10E+02	1.10E+02	1.10E+02
<b>Biased Statistics</b>							
Average Biased	1.11E+02	1.10E+02	1.10E+02	1.09E+02	1.09E+02	1.10E+02	1.10E+02
Std Dev Biased	2.46E+00	1.99E+00	2.01E+00	1.90E+00	1.52E+00	1.86E+00	2.47E+00
Ps90%/90% (+KTL) Biased	1.18E+02	1.15E+02	1.15E+02	1.15E+02	1.13E+02	1.15E+02	1.17E+02
Ps90%/90% (-KTL) Biased	1.04E+02	1.05E+02	1.04E+02	1.04E+02	1.05E+02	1.04E+02	1.04E+02
<b>Un-Biased Statistics</b>							
Average Un-Biased	1.09E+02	1.08E+02	1.07E+02	1.07E+02	1.06E+02	1.06E+02	1.08E+02
Std Dev Un-Biased	3.89E-01	7.41E-01	4.55E-01	4.03E-01	4.71E-01	2.82E-01	7.50E-01
Ps90%/90% (+KTL) Un-Biased	1.10E+02	1.10E+02	1.08E+02	1.08E+02	1.08E+02	1.07E+02	1.10E+02
Ps90%/90% (-KTL) Un-Biased	1.08E+02	1.06E+02	1.06E+02	1.06E+02	1.05E+02	1.06E+02	1.06E+02
<b>Specification MIN</b>	<b>9.70E+01</b>	<b>9.40E+01</b>	<b>9.40E+01</b>	<b>9.20E+01</b>	<b>9.00E+01</b>	<b>9.00E+01</b>	<b>9.00E+01</b>
Status	PASS	PASS	PASS	PASS	PASS	PASS	PASS

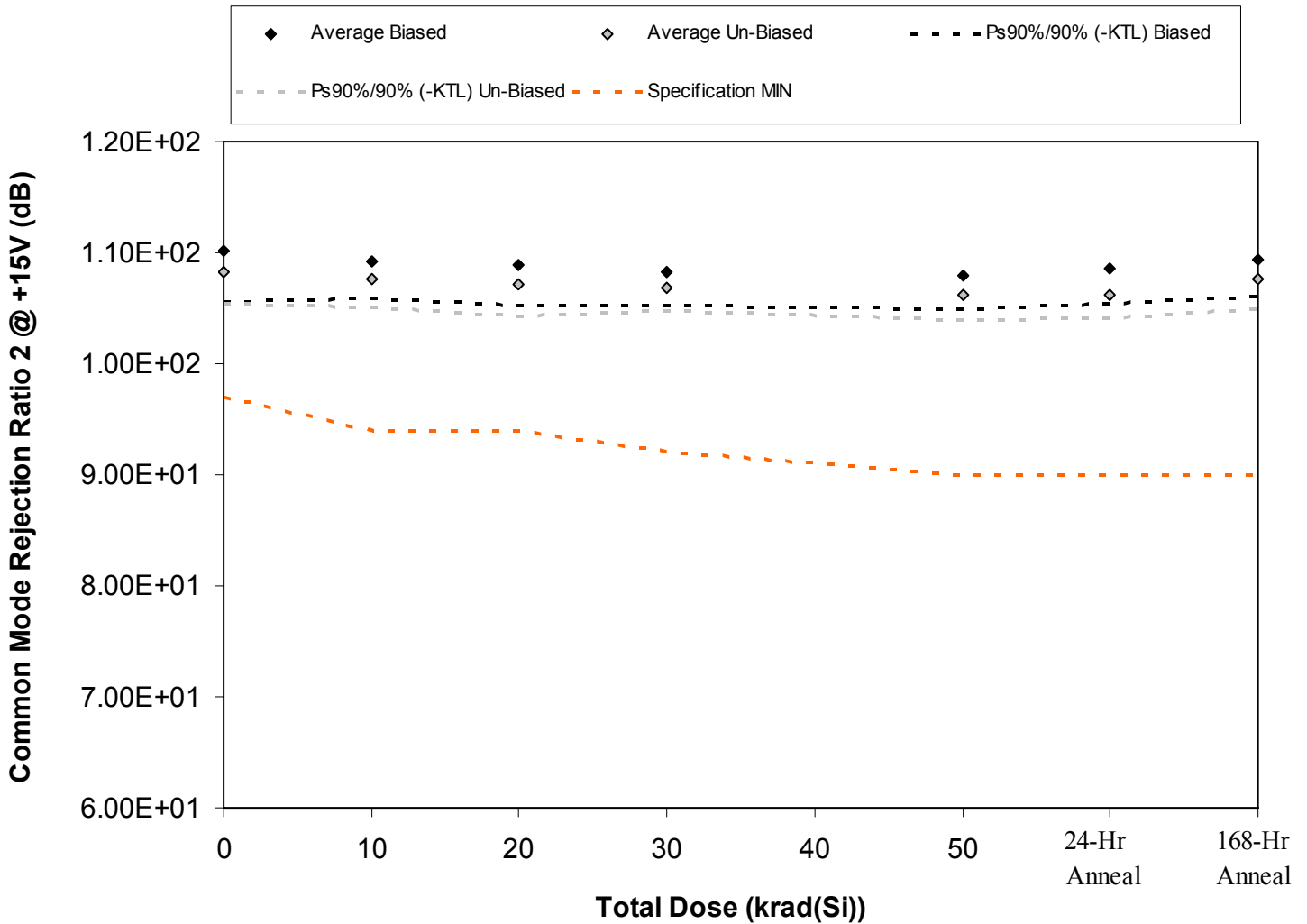

Figure 5.44. Plot of Common Mode Rejection Ratio 2 @ +15V (dB) versus total dose. The solid diamonds are the average of the measured data points for the samples irradiated under electrical bias while the shaded diamonds are the average of the measured data points for the samples irradiated with all pins tied to ground. The black lines (solid and/or dashed) are the average of the data points after application of the KTL statistics on the samples irradiated under electrical bias while the gray lines (solid and/or dashed) are the average of the data points after application of the KTL statistics on the samples irradiated in the unbiased condition. The red dotted line(s) are the pre- and/or post-irradiation minimum and/or maximum specification value as defined in the datasheet and/or test plan.



Table 5.44. Raw data for Common Mode Rejection Ratio 2 @ +15V (dB) versus total dose, including the statistical analysis, specification and the status of the testing (pass/fail).

Common Mode Rejection Ratio 2 @ +15V (dB)	Total Dose (krad(Si))					24 hr Anneal	168 hr Anneal
	0	10	20	30	50		
Device							
255	1.09E+02	1.09E+02	1.08E+02	1.08E+02	1.07E+02	1.08E+02	1.09E+02
258	1.08E+02	1.07E+02	1.07E+02	1.07E+02	1.07E+02	1.07E+02	1.08E+02
309	1.12E+02	1.11E+02	1.10E+02	1.09E+02	1.09E+02	1.10E+02	1.11E+02
359	1.12E+02	1.10E+02	1.10E+02	1.10E+02	1.09E+02	1.10E+02	1.10E+02
360	1.10E+02	1.09E+02	1.08E+02	1.08E+02	1.08E+02	1.08E+02	1.09E+02
416	1.09E+02	1.08E+02	1.08E+02	1.07E+02	1.07E+02	1.07E+02	1.09E+02
472	1.07E+02	1.06E+02	1.06E+02	1.06E+02	1.05E+02	1.05E+02	1.06E+02
473	1.10E+02	1.09E+02	1.08E+02	1.08E+02	1.07E+02	1.07E+02	1.09E+02
526	1.08E+02	1.07E+02	1.07E+02	1.06E+02	1.06E+02	1.06E+02	1.07E+02
529	1.08E+02	1.07E+02	1.07E+02	1.07E+02	1.06E+02	1.06E+02	1.08E+02
530	1.11E+02	1.12E+02	1.12E+02	1.12E+02	1.12E+02	1.12E+02	1.11E+02
561	1.08E+02	1.09E+02	1.09E+02	1.09E+02	1.09E+02	1.09E+02	1.09E+02
<b>Biased Statistics</b>							
Average Biased	1.10E+02	1.09E+02	1.09E+02	1.08E+02	1.08E+02	1.09E+02	1.09E+02
Std Dev Biased	1.64E+00	1.24E+00	1.33E+00	1.13E+00	1.10E+00	1.14E+00	1.18E+00
Ps90%/90% (+KTL) Biased	1.15E+02	1.13E+02	1.12E+02	1.11E+02	1.11E+02	1.12E+02	1.13E+02
Ps90%/90% (-KTL) Biased	1.06E+02	1.06E+02	1.05E+02	1.05E+02	1.05E+02	1.05E+02	1.06E+02
<b>Un-Biased Statistics</b>							
Average Un-Biased	1.08E+02	1.08E+02	1.07E+02	1.07E+02	1.06E+02	1.06E+02	1.08E+02
Std Dev Un-Biased	1.07E+00	9.26E-01	1.00E+00	7.54E-01	8.12E-01	7.84E-01	9.67E-01
Ps90%/90% (+KTL) Un-Biased	1.11E+02	1.10E+02	1.10E+02	1.09E+02	1.08E+02	1.08E+02	1.10E+02
Ps90%/90% (-KTL) Un-Biased	1.05E+02	1.05E+02	1.04E+02	1.05E+02	1.04E+02	1.04E+02	1.05E+02
<b>Specification MIN</b>	<b>9.70E+01</b>	<b>9.40E+01</b>	<b>9.40E+01</b>	<b>9.20E+01</b>	<b>9.00E+01</b>	<b>9.00E+01</b>	<b>9.00E+01</b>
Status	PASS	PASS	PASS	PASS	PASS	PASS	PASS

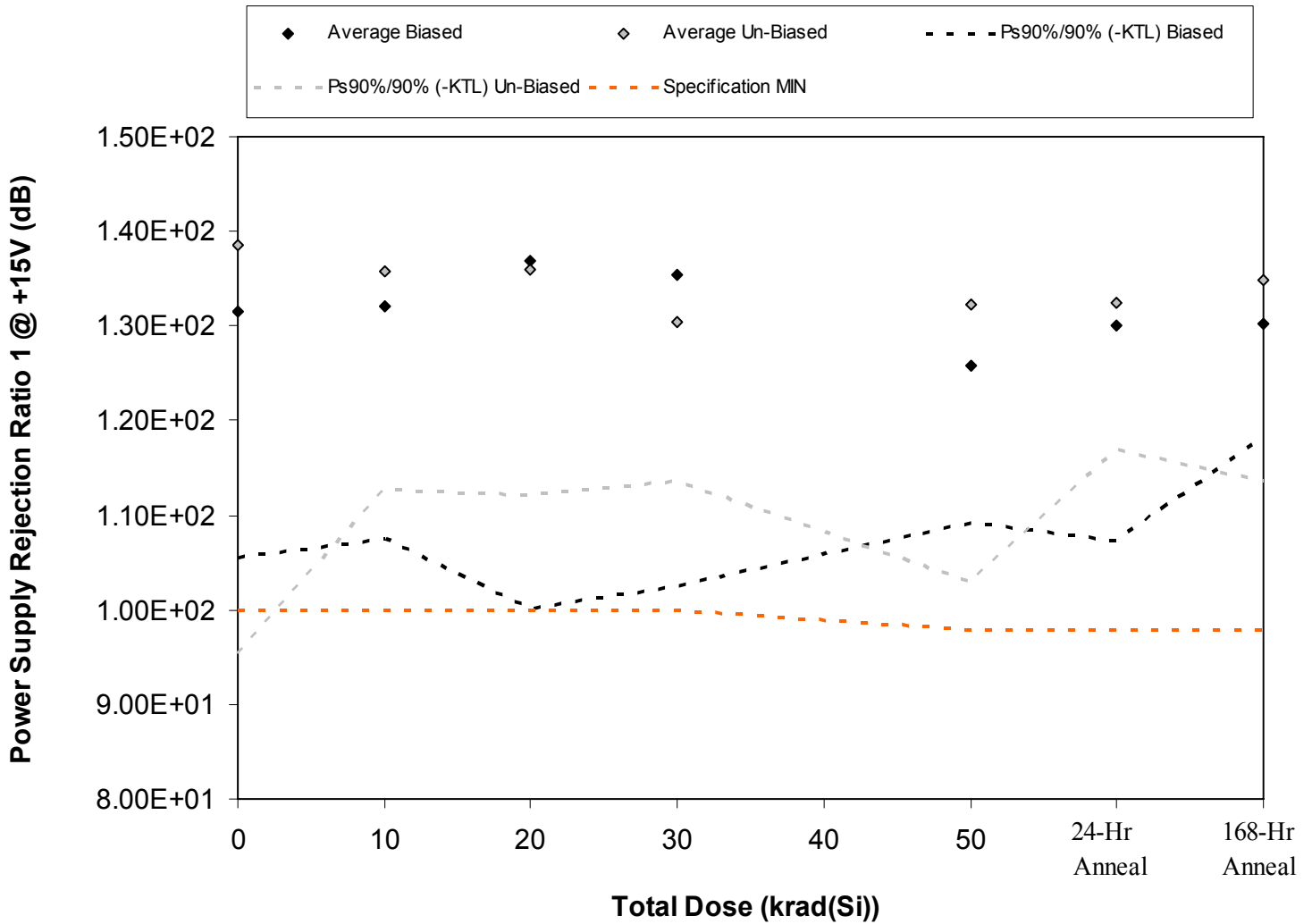

Figure 5.45. Plot of Power Supply Rejection Ratio 1 @ +15V (dB) versus total dose. The solid diamonds are the average of the measured data points for the samples irradiated under electrical bias while the shaded diamonds are the average of the measured data points for the samples irradiated with all pins tied to ground. The black lines (solid and/or dashed) are the average of the data points after application of the KTL statistics on the samples irradiated under electrical bias while the gray lines (solid and/or dashed) are the average of the data points after application of the KTL statistics on the samples irradiated in the unbiased condition. The red dotted line(s) are the pre- and/or post-irradiation minimum and/or maximum specification value as defined in the datasheet and/or test plan.





Table 5.45. Raw data for Power Supply Rejection Ratio 1 @ +15V (dB) versus total dose, including the statistical analysis, specification and the status of the testing (pass/fail).

Power Supply Rejection Ratio 1 @ +15V (dB)	Total Dose (krad(Si))					24 hr Anneal	168 hr Anneal
	0	10	20	30	50		
Device							
255	1.47E+02	1.36E+02	1.59E+02	1.44E+02	1.36E+02	1.25E+02	1.34E+02
258	1.31E+02	1.26E+02	1.26E+02	1.26E+02	1.22E+02	1.25E+02	1.23E+02
309	1.25E+02	1.23E+02	1.27E+02	1.25E+02	1.23E+02	1.24E+02	1.32E+02
359	1.32E+02	1.45E+02	1.34E+02	1.52E+02	1.26E+02	1.43E+02	1.29E+02
360	1.23E+02	1.31E+02	1.39E+02	1.30E+02	1.23E+02	1.34E+02	1.33E+02
416	1.31E+02	1.36E+02	1.34E+02	1.32E+02	1.24E+02	1.33E+02	1.38E+02
472	1.26E+02	1.24E+02	1.23E+02	1.22E+02	1.20E+02	1.23E+02	1.25E+02
473	1.32E+02	1.34E+02	1.36E+02	1.38E+02	1.33E+02	1.32E+02	1.29E+02
526	1.38E+02	1.47E+02	1.41E+02	1.32E+02	1.47E+02	1.35E+02	1.42E+02
529	1.66E+02	1.37E+02	1.46E+02	1.28E+02	1.38E+02	1.39E+02	1.41E+02
530	1.29E+02	1.26E+02	1.28E+02	1.25E+02	1.25E+02	1.30E+02	1.26E+02
561	1.39E+02	1.34E+02	1.30E+02	1.31E+02	1.26E+02	1.30E+02	1.38E+02
<b>Biased Statistics</b>							
Average Biased	1.31E+02	1.32E+02	1.37E+02	1.35E+02	1.26E+02	1.30E+02	1.30E+02
Std Dev Biased	9.45E+00	8.95E+00	1.34E+01	1.20E+01	6.10E+00	8.28E+00	4.33E+00
Ps90%/90% (+KTL) Biased	1.57E+02	1.57E+02	1.73E+02	1.68E+02	1.43E+02	1.53E+02	1.42E+02
Ps90%/90% (-KTL) Biased	1.06E+02	1.08E+02	1.00E+02	1.02E+02	1.09E+02	1.07E+02	1.18E+02
<b>Un-Biased Statistics</b>							
Average Un-Biased	1.39E+02	1.36E+02	1.36E+02	1.30E+02	1.32E+02	1.32E+02	1.35E+02
Std Dev Un-Biased	1.58E+01	8.44E+00	8.66E+00	6.12E+00	1.07E+01	5.64E+00	7.74E+00
Ps90%/90% (+KTL) Un-Biased	1.82E+02	1.59E+02	1.60E+02	1.47E+02	1.62E+02	1.48E+02	1.56E+02
Ps90%/90% (-KTL) Un-Biased	9.53E+01	1.13E+02	1.12E+02	1.14E+02	1.03E+02	1.17E+02	1.14E+02
<b>Specification MIN</b>	<b>1.00E+02</b>	<b>1.00E+02</b>	<b>1.00E+02</b>	<b>1.00E+02</b>	<b>9.80E+01</b>	<b>9.80E+01</b>	<b>9.80E+01</b>
Status	PASS	PASS	PASS	PASS	PASS	PASS	PASS

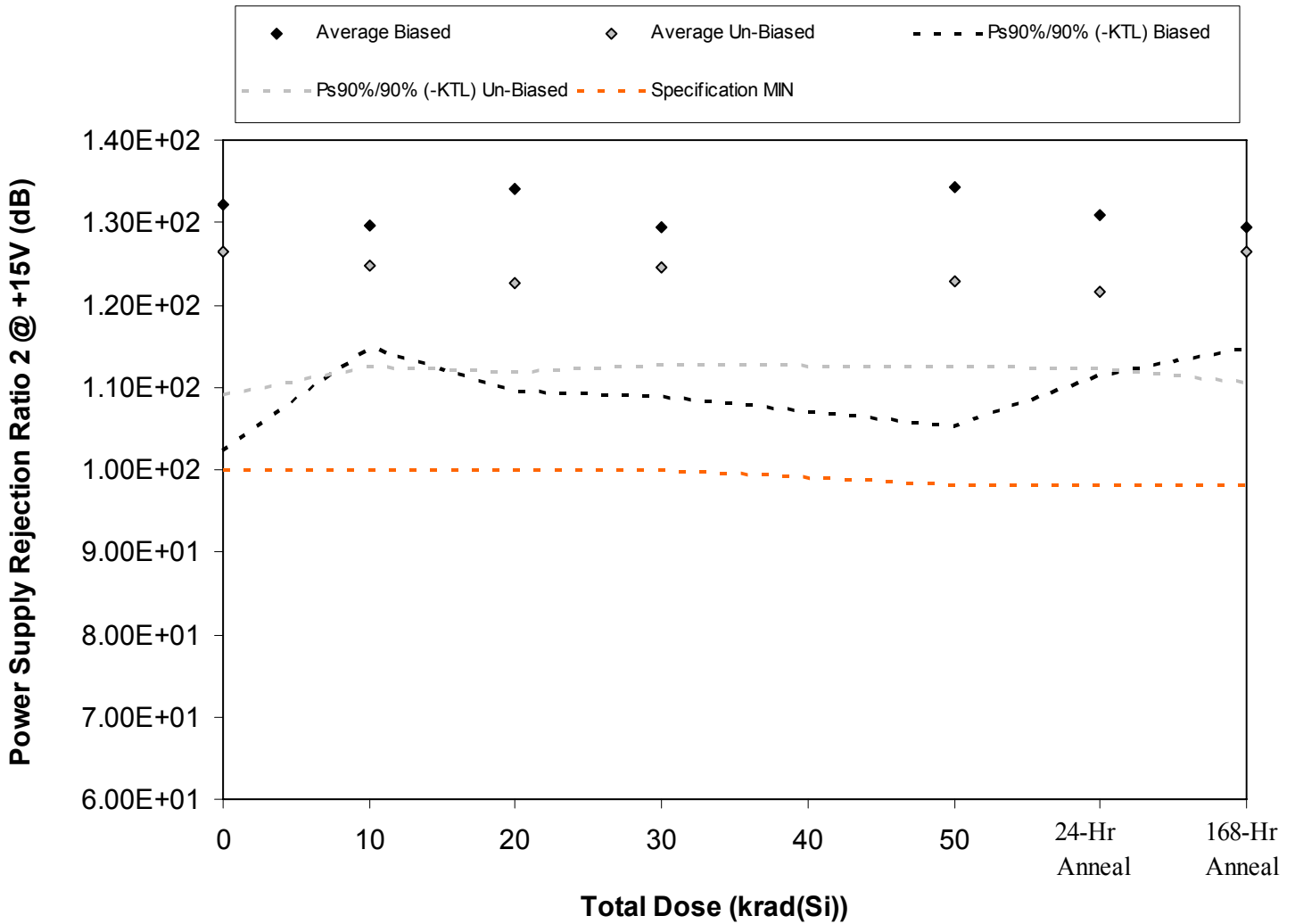

Figure 5.46. Plot of Power Supply Rejection Ratio 2 @ +15V (dB) versus total dose. The solid diamonds are the average of the measured data points for the samples irradiated under electrical bias while the shaded diamonds are the average of the measured data points for the samples irradiated with all pins tied to ground. The black lines (solid and/or dashed) are the average of the data points after application of the KTL statistics on the samples irradiated under electrical bias while the gray lines (solid and/or dashed) are the average of the data points after application of the KTL statistics on the samples irradiated in the unbiased condition. The red dotted line(s) are the pre- and/or post-irradiation minimum and/or maximum specification value as defined in the datasheet and/or test plan.



**TID Report  
10-004 100412 R1.0**

**Radiation Assured Devices  
5017 N. 30th Street  
Colorado Springs, CO 80919  
(719) 531-0800**

Table 5.46. Raw data for Power Supply Rejection Ratio 2 @ +15V (dB) versus total dose, including the statistical analysis, specification and the status of the testing (pass/fail).

Power Supply Rejection Ratio 2 @ +15V (dB)	Total Dose (krad(Si))					24 hr Anneal	168 hr Anneal
	0	10	20	30	50		
Device							
255	1.24E+02	1.23E+02	1.26E+02	1.26E+02	1.25E+02	1.26E+02	1.27E+02
258	1.36E+02	1.34E+02	1.41E+02	1.30E+02	1.43E+02	1.37E+02	1.32E+02
309	1.49E+02	1.34E+02	1.44E+02	1.40E+02	1.45E+02	1.33E+02	1.33E+02
359	1.28E+02	1.33E+02	1.36E+02	1.32E+02	1.38E+02	1.37E+02	1.34E+02
360	1.23E+02	1.24E+02	1.24E+02	1.20E+02	1.22E+02	1.21E+02	1.21E+02
416	1.31E+02	1.23E+02	1.23E+02	1.27E+02	1.23E+02	1.21E+02	1.26E+02
472	1.34E+02	1.25E+02	1.26E+02	1.29E+02	1.27E+02	1.23E+02	1.31E+02
473	1.25E+02	1.31E+02	1.25E+02	1.26E+02	1.26E+02	1.24E+02	1.30E+02
526	1.19E+02	1.19E+02	1.16E+02	1.17E+02	1.17E+02	1.16E+02	1.17E+02
529	1.23E+02	1.27E+02	1.22E+02	1.24E+02	1.22E+02	1.23E+02	1.28E+02
530	1.24E+02	1.24E+02	1.28E+02	1.22E+02	1.23E+02	1.25E+02	1.27E+02
561	1.35E+02	1.26E+02	1.25E+02	1.29E+02	1.26E+02	1.28E+02	1.26E+02
<b>Biased Statistics</b>							
Average Biased	1.32E+02	1.30E+02	1.34E+02	1.29E+02	1.34E+02	1.31E+02	1.29E+02
Std Dev Biased	1.09E+01	5.40E+00	8.94E+00	7.48E+00	1.06E+01	7.07E+00	5.28E+00
Ps90%/90% (+KTL) Biased	1.62E+02	1.44E+02	1.59E+02	1.50E+02	1.63E+02	1.50E+02	1.44E+02
Ps90%/90% (-KTL) Biased	1.02E+02	1.15E+02	1.10E+02	1.09E+02	1.05E+02	1.12E+02	1.15E+02
<b>Un-Biased Statistics</b>							
Average Un-Biased	1.26E+02	1.25E+02	1.23E+02	1.25E+02	1.23E+02	1.22E+02	1.26E+02
Std Dev Un-Biased	6.30E+00	4.47E+00	3.90E+00	4.36E+00	3.81E+00	3.45E+00	5.77E+00
Ps90%/90% (+KTL) Un-Biased	1.44E+02	1.37E+02	1.33E+02	1.37E+02	1.33E+02	1.31E+02	1.42E+02
Ps90%/90% (-KTL) Un-Biased	1.09E+02	1.13E+02	1.12E+02	1.13E+02	1.12E+02	1.12E+02	1.11E+02
<b>Specification MIN</b>	<b>1.00E+02</b>	<b>1.00E+02</b>	<b>1.00E+02</b>	<b>1.00E+02</b>	<b>9.80E+01</b>	<b>9.80E+01</b>	<b>9.80E+01</b>
Status	PASS	PASS	PASS	PASS	PASS	PASS	PASS

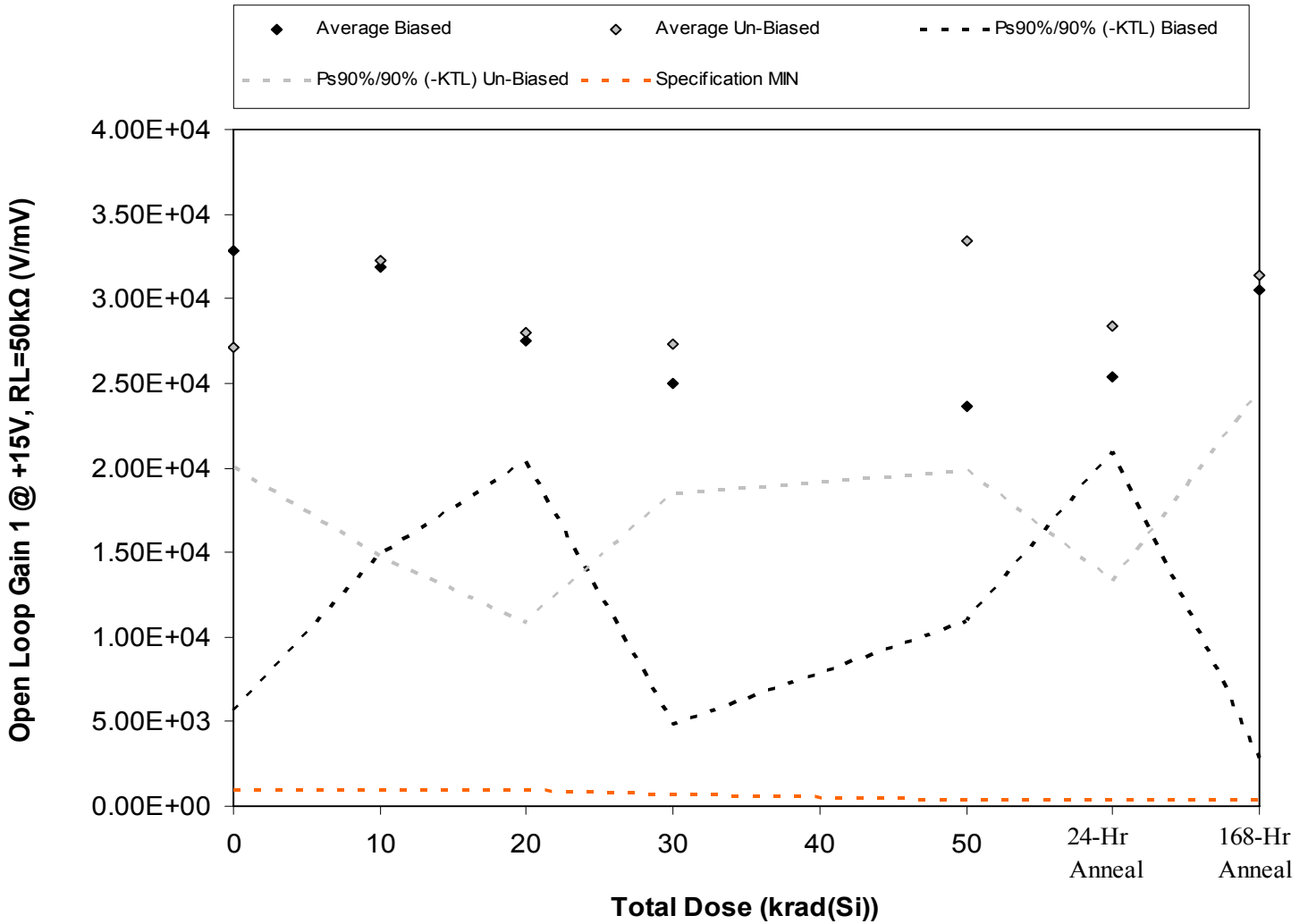

Figure 5.47. Plot of Open Loop Gain 1 @ +15V, RL=50kΩ (V/mV) versus total dose. The solid diamonds are the average of the measured data points for the samples irradiated under electrical bias while the shaded diamonds are the average of the measured data points for the samples irradiated with all pins tied to ground. The black lines (solid and/or dashed) are the average of the data points after application of the KTL statistics on the samples irradiated under electrical bias while the gray lines (solid and/or dashed) are the average of the data points after application of the KTL statistics on the samples irradiated in the unbiased condition. The red dotted line(s) are the pre- and/or post-irradiation minimum and/or maximum specification value as defined in the datasheet and/or test plan.



**TID Report**  
**10-004 100412 R1.0**

**Radiation Assured Devices**  
**5017 N. 30th Street**  
**Colorado Springs, CO 80919**  
**(719) 531-0800**

Table 5.47. Raw data for Open Loop Gain 1 @ +15V, RL=50kΩ (V/mV) versus total dose, including the statistical analysis, specification and the status of the testing (pass/fail).

Open Loop Gain 1 @ +15V, RL=50kΩ (V/mV)	Total Dose (krad(Si))					24 hr Anneal	168 hr Anneal
	0	10	20	30	50		
Device							
255	4.71E+04	2.51E+04	2.80E+04	2.00E+04	2.33E+04	2.37E+04	2.87E+04
258	2.91E+04	2.95E+04	2.48E+04	2.63E+04	2.00E+04	2.61E+04	1.51E+04
309	2.34E+04	3.14E+04	2.50E+04	3.69E+04	2.15E+04	2.57E+04	4.21E+04
359	2.57E+04	3.17E+04	3.09E+04	2.33E+04	3.16E+04	2.39E+04	3.04E+04
360	3.88E+04	4.19E+04	2.89E+04	1.83E+04	2.17E+04	2.77E+04	3.62E+04
416	3.00E+04	3.90E+04	2.78E+04	2.86E+04	3.52E+04	2.41E+04	3.32E+04
472	2.46E+04	3.64E+04	3.50E+04	3.06E+04	2.63E+04	2.32E+04	3.00E+04
473	2.65E+04	2.24E+04	1.84E+04	2.59E+04	3.96E+04	2.88E+04	3.49E+04
526	2.47E+04	3.05E+04	3.19E+04	2.24E+04	3.15E+04	2.87E+04	2.91E+04
529	2.96E+04	3.28E+04	2.70E+04	2.89E+04	3.44E+04	3.71E+04	2.98E+04
530	2.93E+04	3.59E+04	2.29E+04	2.58E+04	3.50E+04	3.01E+04	3.70E+04
561	2.55E+04	2.41E+04	3.56E+04	2.75E+04	2.84E+04	4.98E+04	1.79E+04
<b>Biased Statistics</b>							
Average Biased	3.28E+04	3.19E+04	2.75E+04	2.49E+04	2.36E+04	2.54E+04	3.05E+04
Std Dev Biased	9.91E+03	6.19E+03	2.63E+03	7.34E+03	4.63E+03	1.64E+03	1.01E+04
Ps90%/90% (+KTL) Biased	6.00E+04	4.89E+04	3.47E+04	4.51E+04	3.63E+04	2.99E+04	5.81E+04
Ps90%/90% (-KTL) Biased	5.65E+03	1.49E+04	2.03E+04	4.81E+03	1.09E+04	2.09E+04	2.79E+03
<b>Un-Biased Statistics</b>							
Average Un-Biased	2.71E+04	3.22E+04	2.80E+04	2.73E+04	3.34E+04	2.84E+04	3.14E+04
Std Dev Un-Biased	2.57E+03	6.39E+03	6.27E+03	3.19E+03	4.94E+03	5.50E+03	2.50E+03
Ps90%/90% (+KTL) Un-Biased	3.41E+04	4.97E+04	4.52E+04	3.60E+04	4.69E+04	4.35E+04	3.83E+04
Ps90%/90% (-KTL) Un-Biased	2.00E+04	1.47E+04	1.08E+04	1.85E+04	1.98E+04	1.33E+04	2.45E+04
<b>Specification MIN</b>	<b>1.00E+03</b>	<b>1.00E+03</b>	<b>1.00E+03</b>	<b>7.00E+02</b>	<b>4.00E+02</b>	<b>4.00E+02</b>	<b>4.00E+02</b>
Status	PASS	PASS	PASS	PASS	PASS	PASS	PASS

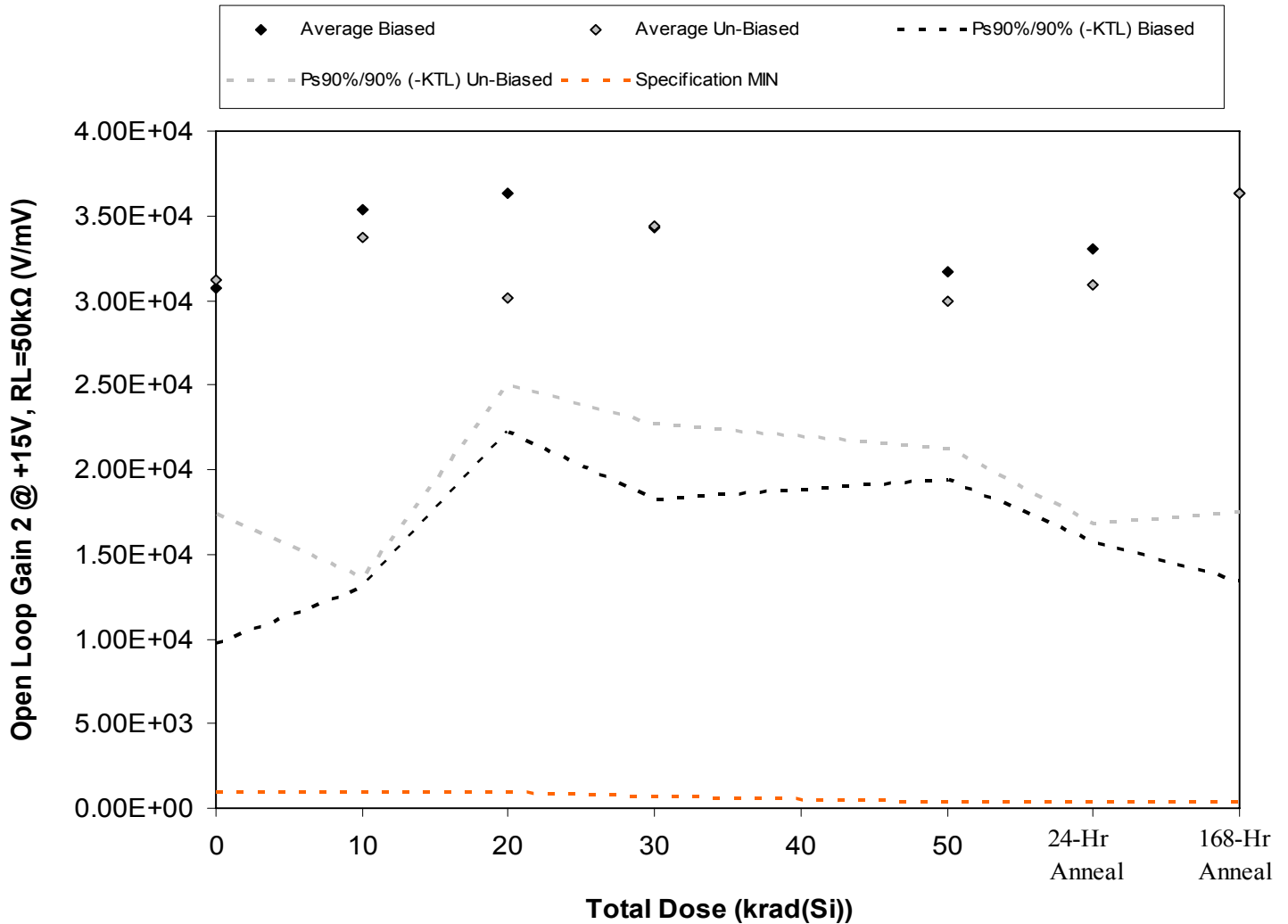

Figure 5.48. Plot of Open Loop Gain 2 @ +15V, RL=50kΩ (V/mV) versus total dose. The solid diamonds are the average of the measured data points for the samples irradiated under electrical bias while the shaded diamonds are the average of the measured data points for the samples irradiated with all pins tied to ground. The black lines (solid and/or dashed) are the average of the data points after application of the KTL statistics on the samples irradiated under electrical bias while the gray lines (solid and/or dashed) are the average of the data points after application of the KTL statistics on the samples irradiated in the unbiased condition. The red dotted line(s) are the pre- and/or post-irradiation minimum and/or maximum specification value as defined in the datasheet and/or test plan.



**TID Report**  
**10-004 100412 R1.0**

**Radiation Assured Devices**  
**5017 N. 30th Street**  
**Colorado Springs, CO 80919**  
**(719) 531-0800**

Table 5.48. Raw data for Open Loop Gain 2 @ +15V, RL=50kΩ (V/mV) versus total dose, including the statistical analysis, specification and the status of the testing (pass/fail).

Open Loop Gain 2 @ +15V, RL=50kΩ (V/mV)	Total Dose (krad(Si))					24 hr Anneal	168 hr Anneal
	0	10	20	30	50		
Device							
255	3.44E+04	4.86E+04	3.62E+04	2.77E+04	3.90E+04	2.54E+04	4.23E+04
258	2.30E+04	3.19E+04	4.44E+04	3.46E+04	2.92E+04	3.06E+04	2.47E+04
309	2.21E+04	2.80E+04	3.43E+04	3.75E+04	3.30E+04	3.66E+04	4.60E+04
359	3.89E+04	3.74E+04	3.68E+04	4.20E+04	2.77E+04	4.18E+04	3.25E+04
360	3.52E+04	3.10E+04	3.02E+04	2.95E+04	2.97E+04	3.06E+04	3.63E+04
416	2.71E+04	3.01E+04	3.23E+04	2.81E+04	2.99E+04	3.30E+04	3.21E+04
472	2.50E+04	4.45E+04	2.90E+04	3.42E+04	3.39E+04	3.24E+04	4.22E+04
473	3.40E+04	3.06E+04	2.76E+04	3.31E+04	3.23E+04	2.77E+04	4.11E+04
526	3.72E+04	3.76E+04	3.11E+04	3.71E+04	2.70E+04	2.42E+04	3.99E+04
529	3.28E+04	2.59E+04	3.05E+04	3.93E+04	2.67E+04	3.75E+04	2.63E+04
530	4.11E+04	4.55E+04	3.79E+04	3.55E+04	4.68E+04	3.63E+04	4.32E+04
561	2.73E+04	3.48E+04	2.63E+04	4.07E+04	2.75E+04	3.98E+04	4.66E+04
<b>Biased Statistics</b>							
Average Biased	3.07E+04	3.54E+04	3.64E+04	3.43E+04	3.17E+04	3.30E+04	3.63E+04
Std Dev Biased	7.67E+03	8.14E+03	5.16E+03	5.82E+03	4.49E+03	6.30E+03	8.34E+03
Ps90%/90% (+KTL) Biased	5.18E+04	5.77E+04	5.05E+04	5.02E+04	4.40E+04	5.03E+04	5.92E+04
Ps90%/90% (-KTL) Biased	9.73E+03	1.31E+04	2.22E+04	1.83E+04	1.94E+04	1.57E+04	1.35E+04
<b>Un-Biased Statistics</b>							
Average Un-Biased	3.12E+04	3.37E+04	3.01E+04	3.43E+04	3.00E+04	3.10E+04	3.63E+04
Std Dev Un-Biased	5.03E+03	7.34E+03	1.86E+03	4.24E+03	3.19E+03	5.16E+03	6.87E+03
Ps90%/90% (+KTL) Un-Biased	4.50E+04	5.39E+04	3.52E+04	4.60E+04	3.87E+04	4.51E+04	5.51E+04
Ps90%/90% (-KTL) Un-Biased	1.74E+04	1.36E+04	2.50E+04	2.27E+04	2.12E+04	1.68E+04	1.75E+04
<b>Specification MIN</b>	<b>1.00E+03</b>	<b>1.00E+03</b>	<b>1.00E+03</b>	<b>7.00E+02</b>	<b>4.00E+02</b>	<b>4.00E+02</b>	<b>4.00E+02</b>
Status	PASS	PASS	PASS	PASS	PASS	PASS	PASS

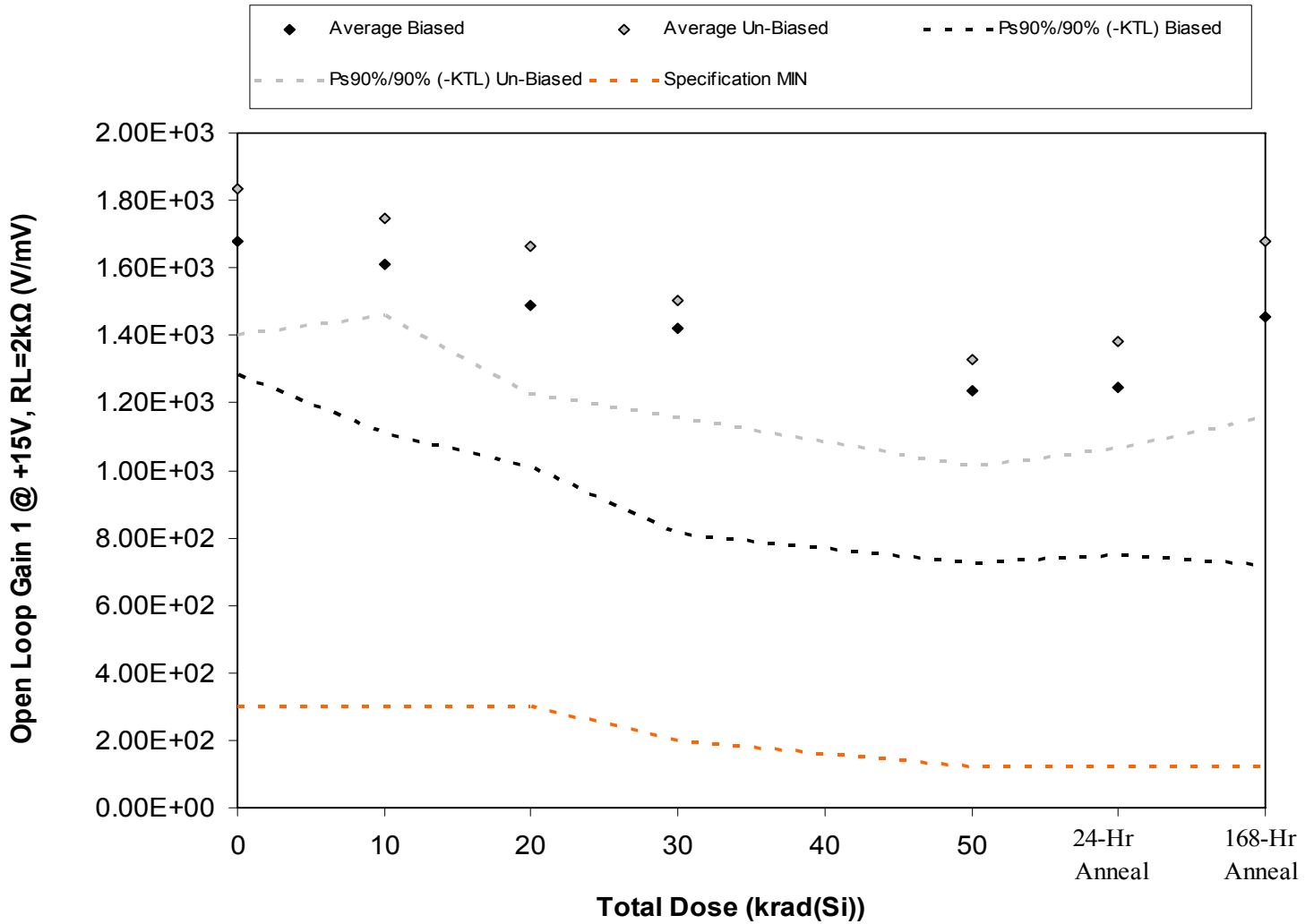

Figure 5.49. Plot of Open Loop Gain 1 @ +15V, RL=2kΩ (V/mV) versus total dose. The solid diamonds are the average of the measured data points for the samples irradiated under electrical bias while the shaded diamonds are the average of the measured data points for the samples irradiated with all pins tied to ground. The black lines (solid and/or dashed) are the average of the data points after application of the KTL statistics on the samples irradiated under electrical bias while the gray lines (solid and/or dashed) are the average of the data points after application of the KTL statistics on the samples irradiated in the unbiased condition. The red dotted line(s) are the pre- and/or post-irradiation minimum and/or maximum specification value as defined in the datasheet and/or test plan.





Table 5.49. Raw data for Open Loop Gain 1 @ +15V, RL=2kΩ (V/mV) versus total dose, including the statistical analysis, specification and the status of the testing (pass/fail).

Open Loop Gain 1 @ +15V, RL=2kΩ (V/mV)	Total Dose (krad(Si))					24 hr Anneal	168 hr Anneal
	0	10	20	30	50		
Device							
255	1.54E+03	1.49E+03	1.40E+03	1.26E+03	1.07E+03	1.11E+03	1.25E+03
258	1.62E+03	1.48E+03	1.43E+03	1.31E+03	1.11E+03	1.14E+03	1.25E+03
309	1.89E+03	1.92E+03	1.79E+03	1.81E+03	1.53E+03	1.53E+03	1.88E+03
359	1.76E+03	1.64E+03	1.46E+03	1.39E+03	1.30E+03	1.30E+03	1.55E+03
360	1.58E+03	1.52E+03	1.36E+03	1.35E+03	1.16E+03	1.13E+03	1.34E+03
416	1.86E+03	1.72E+03	1.63E+03	1.39E+03	1.25E+03	1.31E+03	1.61E+03
472	1.62E+03	1.60E+03	1.47E+03	1.40E+03	1.20E+03	1.24E+03	1.50E+03
473	1.91E+03	1.79E+03	1.70E+03	1.62E+03	1.35E+03	1.47E+03	1.76E+03
526	1.75E+03	1.74E+03	1.63E+03	1.46E+03	1.36E+03	1.37E+03	1.56E+03
529	2.03E+03	1.88E+03	1.91E+03	1.66E+03	1.50E+03	1.52E+03	1.98E+03
530	2.32E+03	2.15E+03	2.23E+03	2.14E+03	2.21E+03	2.17E+03	2.13E+03
561	1.68E+03	1.63E+03	1.65E+03	1.66E+03	1.56E+03	1.58E+03	1.59E+03
<b>Biased Statistics</b>							
Average Biased	1.68E+03	1.61E+03	1.49E+03	1.42E+03	1.23E+03	1.24E+03	1.45E+03
Std Dev Biased	1.44E+02	1.83E+02	1.74E+02	2.21E+02	1.86E+02	1.80E+02	2.68E+02
Ps90%/90% (+KTL) Biased	2.07E+03	2.11E+03	1.97E+03	2.03E+03	1.74E+03	1.74E+03	2.19E+03
Ps90%/90% (-KTL) Biased	1.28E+03	1.11E+03	1.01E+03	8.15E+02	7.25E+02	7.50E+02	7.19E+02
<b>Un-Biased Statistics</b>							
Average Un-Biased	1.83E+03	1.75E+03	1.67E+03	1.51E+03	1.33E+03	1.38E+03	1.68E+03
Std Dev Un-Biased	1.57E+02	1.04E+02	1.60E+02	1.26E+02	1.16E+02	1.14E+02	1.91E+02
Ps90%/90% (+KTL) Un-Biased	2.26E+03	2.03E+03	2.10E+03	1.85E+03	1.65E+03	1.69E+03	2.20E+03
Ps90%/90% (-KTL) Un-Biased	1.40E+03	1.46E+03	1.23E+03	1.16E+03	1.01E+03	1.07E+03	1.16E+03
<b>Specification MIN</b>	<b>3.00E+02</b>	<b>3.00E+02</b>	<b>3.00E+02</b>	<b>2.00E+02</b>	<b>1.20E+02</b>	<b>1.20E+02</b>	<b>1.20E+02</b>
Status	PASS	PASS	PASS	PASS	PASS	PASS	PASS

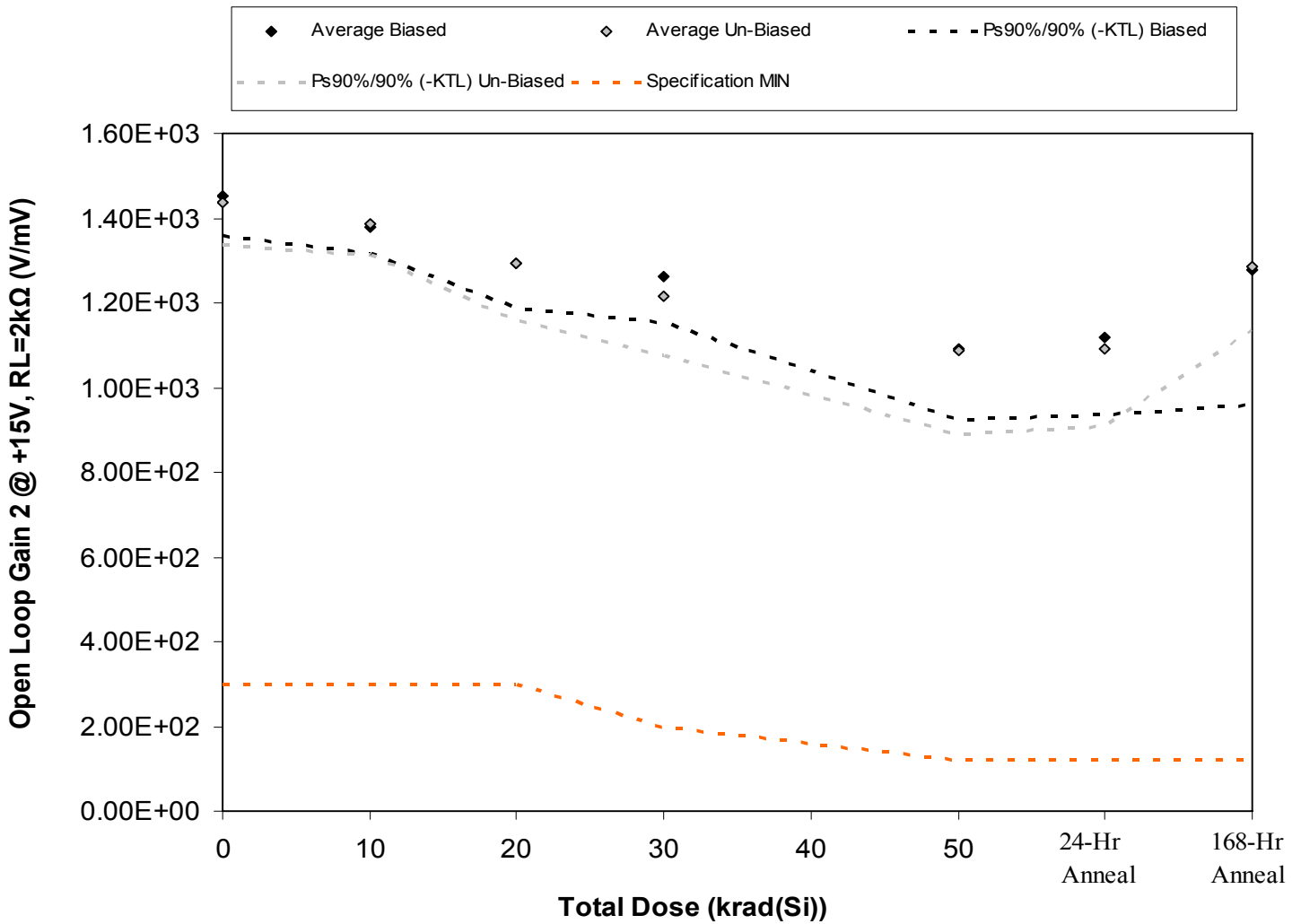

Figure 5.50. Plot of Open Loop Gain 2 @ +15V, RL=2kΩ (V/mV) versus total dose. The solid diamonds are the average of the measured data points for the samples irradiated under electrical bias while the shaded diamonds are the average of the measured data points for the samples irradiated with all pins tied to ground. The black lines (solid and/or dashed) are the average of the data points after application of the KTL statistics on the samples irradiated under electrical bias while the gray lines (solid and/or dashed) are the average of the data points after application of the KTL statistics on the samples irradiated in the unbiased condition. The red dotted line(s) are the pre- and/or post-irradiation minimum and/or maximum specification value as defined in the datasheet and/or test plan.



**TID Report**  
**10-004 100412 R1.0**

**Radiation Assured Devices**  
**5017 N. 30th Street**  
**Colorado Springs, CO 80919**  
**(719) 531-0800**

Table 5.50. Raw data for Open Loop Gain 2 @ +15V, RL=2kΩ (V/mV) versus total dose, including the statistical analysis, specification and the status of the testing (pass/fail).

Open Loop Gain 2 @ +15V, RL=2kΩ (V/mV)	Total Dose (krad(Si))					24 hr Anneal	168 hr Anneal
	0	10	20	30	50		
Device							
255	1.46E+03	1.39E+03	1.27E+03	1.28E+03	1.05E+03	1.08E+03	1.22E+03
258	1.48E+03	1.41E+03	1.34E+03	1.30E+03	1.16E+03	1.20E+03	1.44E+03
309	1.49E+03	1.37E+03	1.33E+03	1.25E+03	1.08E+03	1.12E+03	1.31E+03
359	1.43E+03	1.37E+03	1.28E+03	1.29E+03	1.14E+03	1.16E+03	1.30E+03
360	1.41E+03	1.35E+03	1.25E+03	1.20E+03	1.02E+03	1.03E+03	1.13E+03
416	1.37E+03	1.34E+03	1.21E+03	1.15E+03	1.01E+03	1.03E+03	1.23E+03
472	1.44E+03	1.41E+03	1.35E+03	1.29E+03	1.20E+03	1.17E+03	1.36E+03
473	1.46E+03	1.39E+03	1.30E+03	1.23E+03	1.09E+03	1.02E+03	1.24E+03
526	1.45E+03	1.39E+03	1.30E+03	1.19E+03	1.05E+03	1.10E+03	1.28E+03
529	1.46E+03	1.40E+03	1.31E+03	1.21E+03	1.09E+03	1.13E+03	1.33E+03
530	1.47E+03	1.41E+03	1.43E+03	1.41E+03	1.40E+03	1.40E+03	1.43E+03
561	1.51E+03	1.52E+03	1.49E+03	1.49E+03	1.51E+03	1.50E+03	1.53E+03
<b>Biased Statistics</b>							
Average Biased	1.45E+03	1.38E+03	1.29E+03	1.26E+03	1.09E+03	1.12E+03	1.28E+03
Std Dev Biased	3.45E+01	2.20E+01	3.83E+01	4.02E+01	6.08E+01	6.70E+01	1.16E+02
Ps90%/90% (+KTL) Biased	1.55E+03	1.44E+03	1.40E+03	1.37E+03	1.26E+03	1.30E+03	1.60E+03
Ps90%/90% (-KTL) Biased	1.36E+03	1.32E+03	1.19E+03	1.15E+03	9.23E+02	9.35E+02	9.59E+02
<b>Un-Biased Statistics</b>							
Average Un-Biased	1.44E+03	1.39E+03	1.29E+03	1.21E+03	1.09E+03	1.09E+03	1.29E+03
Std Dev Un-Biased	3.67E+01	2.62E+01	5.03E+01	5.13E+01	7.13E+01	6.60E+01	5.58E+01
Ps90%/90% (+KTL) Un-Biased	1.54E+03	1.46E+03	1.43E+03	1.36E+03	1.28E+03	1.27E+03	1.44E+03
Ps90%/90% (-KTL) Un-Biased	1.34E+03	1.31E+03	1.16E+03	1.07E+03	8.91E+02	9.09E+02	1.13E+03
<b>Specification MIN</b>	<b>3.00E+02</b>	<b>3.00E+02</b>	<b>3.00E+02</b>	<b>2.00E+02</b>	<b>1.20E+02</b>	<b>1.20E+02</b>	<b>1.20E+02</b>
Status	PASS	PASS	PASS	PASS	PASS	PASS	PASS

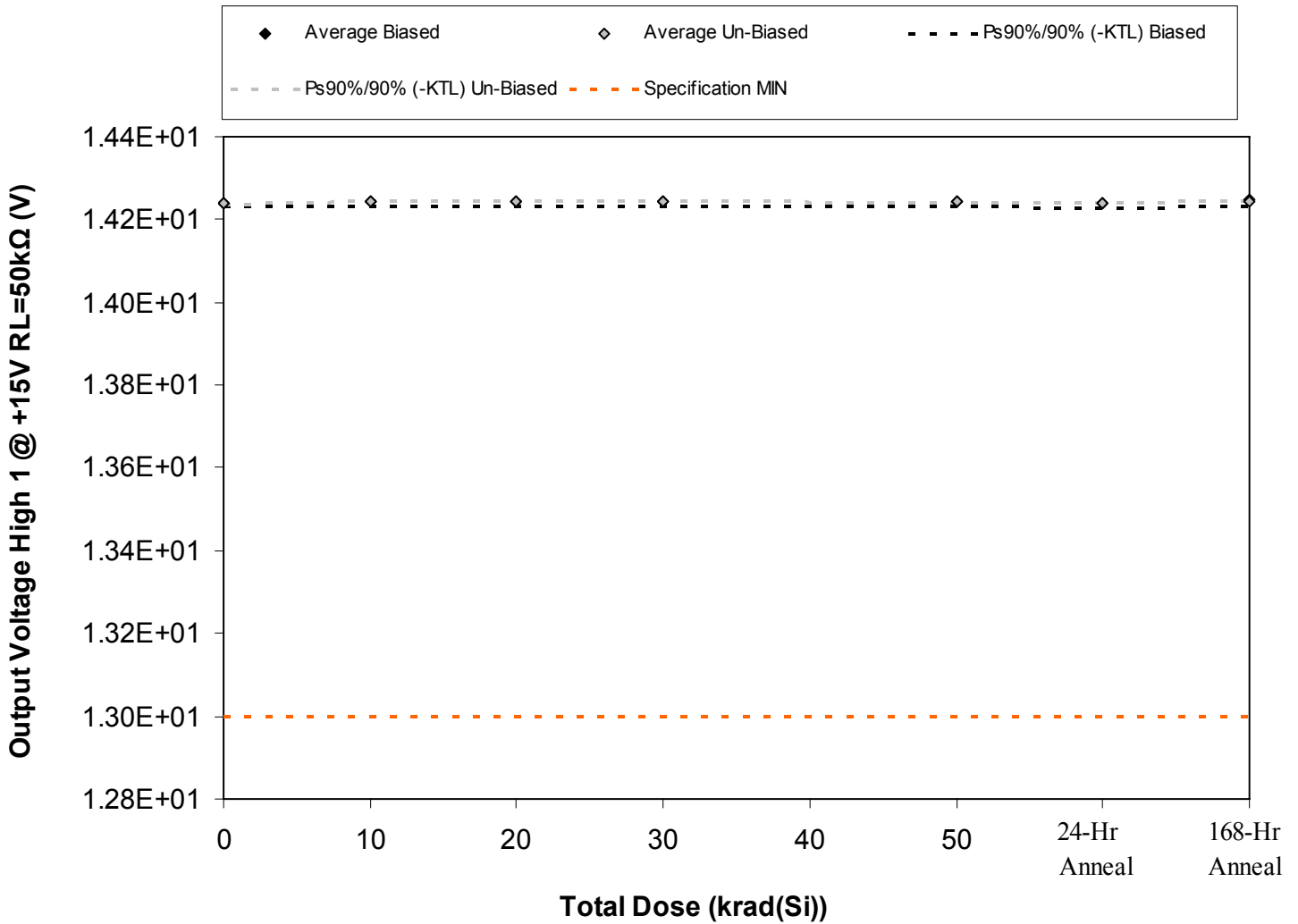

Figure 5.51. Plot of Output Voltage High 1 @ +15V RL=50kΩ (V) versus total dose. The solid diamonds are the average of the measured data points for the samples irradiated under electrical bias while the shaded diamonds are the average of the measured data points for the samples irradiated with all pins tied to ground. The black lines (solid and/or dashed) are the average of the data points after application of the KTL statistics on the samples irradiated under electrical bias while the gray lines (solid and/or dashed) are the average of the data points after application of the KTL statistics on the samples irradiated in the unbiased condition. The red dotted line(s) are the pre- and/or post-irradiation minimum and/or maximum specification value as defined in the datasheet and/or test plan.



Table 5.51. Raw data for Output Voltage High 1 @ +15V RL=50kΩ (V) versus total dose, including the statistical analysis, specification and the status of the testing (pass/fail).

Output Voltage High 1 @ +15V RL=50kΩ (V)	Total Dose (krad(Si))					24 hr Anneal	168 hr Anneal
	0	10	20	30	50		
Device							
255	1.42E+01	1.42E+01	1.42E+01	1.42E+01	1.42E+01	1.42E+01	1.42E+01
258	1.42E+01	1.42E+01	1.42E+01	1.42E+01	1.42E+01	1.42E+01	1.42E+01
309	1.42E+01	1.42E+01	1.42E+01	1.42E+01	1.42E+01	1.42E+01	1.42E+01
359	1.42E+01	1.43E+01	1.43E+01	1.43E+01	1.42E+01	1.42E+01	1.43E+01
360	1.42E+01	1.42E+01	1.42E+01	1.42E+01	1.42E+01	1.42E+01	1.42E+01
416	1.42E+01	1.42E+01	1.42E+01	1.42E+01	1.42E+01	1.42E+01	1.42E+01
472	1.42E+01	1.42E+01	1.42E+01	1.42E+01	1.42E+01	1.42E+01	1.42E+01
473	1.42E+01	1.42E+01	1.42E+01	1.42E+01	1.42E+01	1.42E+01	1.42E+01
526	1.42E+01	1.42E+01	1.42E+01	1.42E+01	1.42E+01	1.42E+01	1.42E+01
529	1.42E+01	1.42E+01	1.42E+01	1.42E+01	1.42E+01	1.42E+01	1.42E+01
530	1.42E+01	1.42E+01	1.42E+01	1.42E+01	1.42E+01	1.42E+01	1.43E+01
561	1.42E+01	1.42E+01	1.42E+01	1.42E+01	1.42E+01	1.42E+01	1.42E+01
<b>Biased Statistics</b>							
Average Biased	1.42E+01	1.42E+01	1.42E+01	1.42E+01	1.42E+01	1.42E+01	1.42E+01
Std Dev Biased	4.21E-03	4.51E-03	4.69E-03	4.83E-03	4.77E-03	4.60E-03	4.69E-03
Ps90%/90% (+KTL) Biased	1.43E+01	1.43E+01	1.43E+01	1.43E+01	1.43E+01	1.43E+01	1.43E+01
Ps90%/90% (-KTL) Biased	1.42E+01	1.42E+01	1.42E+01	1.42E+01	1.42E+01	1.42E+01	1.42E+01
<b>Un-Biased Statistics</b>							
Average Un-Biased	1.42E+01	1.42E+01	1.42E+01	1.42E+01	1.42E+01	1.42E+01	1.42E+01
Std Dev Un-Biased	8.94E-04	4.47E-04	8.94E-04	8.94E-04	5.48E-04	4.47E-04	4.47E-04
Ps90%/90% (+KTL) Un-Biased	1.42E+01	1.42E+01	1.42E+01	1.42E+01	1.42E+01	1.42E+01	1.42E+01
Ps90%/90% (-KTL) Un-Biased	1.42E+01	1.42E+01	1.42E+01	1.42E+01	1.42E+01	1.42E+01	1.42E+01
<b>Specification MIN</b>	<b>1.30E+01</b>	<b>1.30E+01</b>	<b>1.30E+01</b>	<b>1.30E+01</b>	<b>1.30E+01</b>	<b>1.30E+01</b>	<b>1.30E+01</b>
Status	PASS	PASS	PASS	PASS	PASS	PASS	PASS

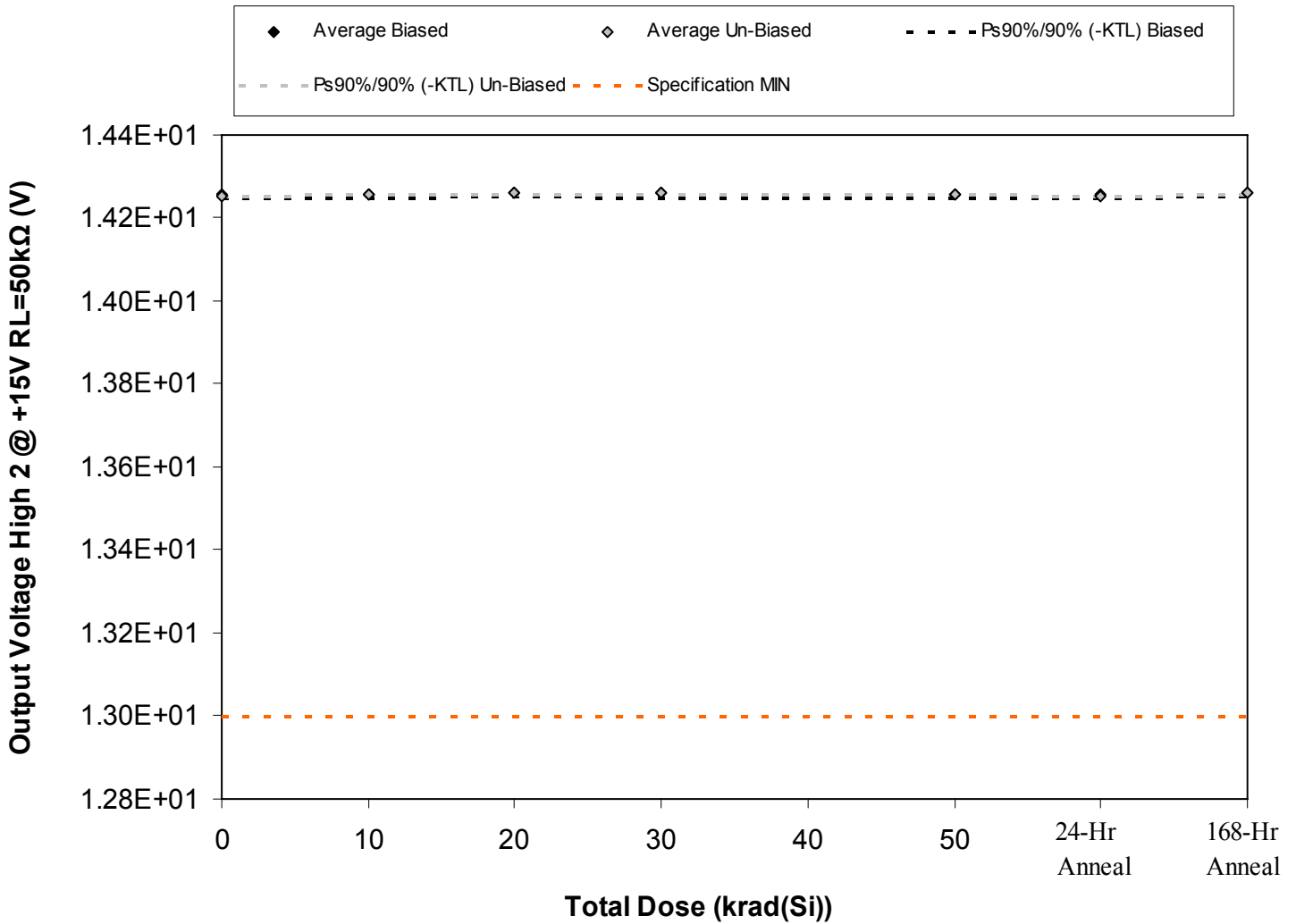

Figure 5.52. Plot of Output Voltage High 2 @ +15V RL=50kΩ (V) versus total dose. The solid diamonds are the average of the measured data points for the samples irradiated under electrical bias while the shaded diamonds are the average of the measured data points for the samples irradiated with all pins tied to ground. The black lines (solid and/or dashed) are the average of the data points after application of the KTL statistics on the samples irradiated under electrical bias while the gray lines (solid and/or dashed) are the average of the data points after application of the KTL statistics on the samples irradiated in the unbiased condition. The red dotted line(s) are the pre- and/or post-irradiation minimum and/or maximum specification value as defined in the datasheet and/or test plan.



Table 5.52. Raw data for Output Voltage High 2 @ +15V RL=50kΩ (V) versus total dose, including the statistical analysis, specification and the status of the testing (pass/fail).

Output Voltage High 2 @ +15V RL=50kΩ (V)	Total Dose (krad(Si))					24 hr Anneal	168 hr Anneal
	0	10	20	30	50		
Device							
255	1.43E+01	1.43E+01	1.43E+01	1.43E+01	1.43E+01	1.43E+01	1.43E+01
258	1.43E+01	1.43E+01	1.43E+01	1.43E+01	1.43E+01	1.43E+01	1.43E+01
309	1.43E+01	1.43E+01	1.43E+01	1.43E+01	1.43E+01	1.43E+01	1.43E+01
359	1.43E+01	1.43E+01	1.43E+01	1.43E+01	1.43E+01	1.43E+01	1.43E+01
360	1.43E+01	1.43E+01	1.43E+01	1.43E+01	1.43E+01	1.43E+01	1.43E+01
416	1.43E+01	1.43E+01	1.43E+01	1.43E+01	1.43E+01	1.43E+01	1.43E+01
472	1.43E+01	1.43E+01	1.43E+01	1.43E+01	1.43E+01	1.43E+01	1.43E+01
473	1.43E+01	1.43E+01	1.43E+01	1.43E+01	1.43E+01	1.43E+01	1.43E+01
526	1.43E+01	1.43E+01	1.43E+01	1.43E+01	1.43E+01	1.43E+01	1.43E+01
529	1.43E+01	1.43E+01	1.43E+01	1.43E+01	1.43E+01	1.43E+01	1.43E+01
530	1.43E+01	1.43E+01	1.43E+01	1.43E+01	1.43E+01	1.43E+01	1.43E+01
561	1.43E+01	1.43E+01	1.43E+01	1.43E+01	1.43E+01	1.43E+01	1.43E+01
<b>Biased Statistics</b>							
Average Biased	1.43E+01	1.43E+01	1.43E+01	1.43E+01	1.43E+01	1.43E+01	1.43E+01
Std Dev Biased	2.39E-03	3.03E-03	2.88E-03	3.63E-03	3.49E-03	2.95E-03	2.61E-03
Ps90%/90% (+KTL) Biased	1.43E+01	1.43E+01	1.43E+01	1.43E+01	1.43E+01	1.43E+01	1.43E+01
Ps90%/90% (-KTL) Biased	1.42E+01	1.43E+01	1.43E+01	1.43E+01	1.42E+01	1.42E+01	1.43E+01
<b>Un-Biased Statistics</b>							
Average Un-Biased	1.43E+01	1.43E+01	1.43E+01	1.43E+01	1.43E+01	1.43E+01	1.43E+01
Std Dev Un-Biased	5.48E-04	8.94E-04	1.34E-03	7.07E-04	0.00E+00	8.94E-04	8.94E-04
Ps90%/90% (+KTL) Un-Biased	1.43E+01	1.43E+01	1.43E+01	1.43E+01	1.43E+01	1.43E+01	1.43E+01
Ps90%/90% (-KTL) Un-Biased	1.43E+01	1.43E+01	1.43E+01	1.43E+01	1.43E+01	1.43E+01	1.43E+01
<b>Specification MIN</b>	<b>1.30E+01</b>	<b>1.30E+01</b>	<b>1.30E+01</b>	<b>1.30E+01</b>	<b>1.30E+01</b>	<b>1.30E+01</b>	<b>1.30E+01</b>
Status	PASS	PASS	PASS	PASS	PASS	PASS	PASS

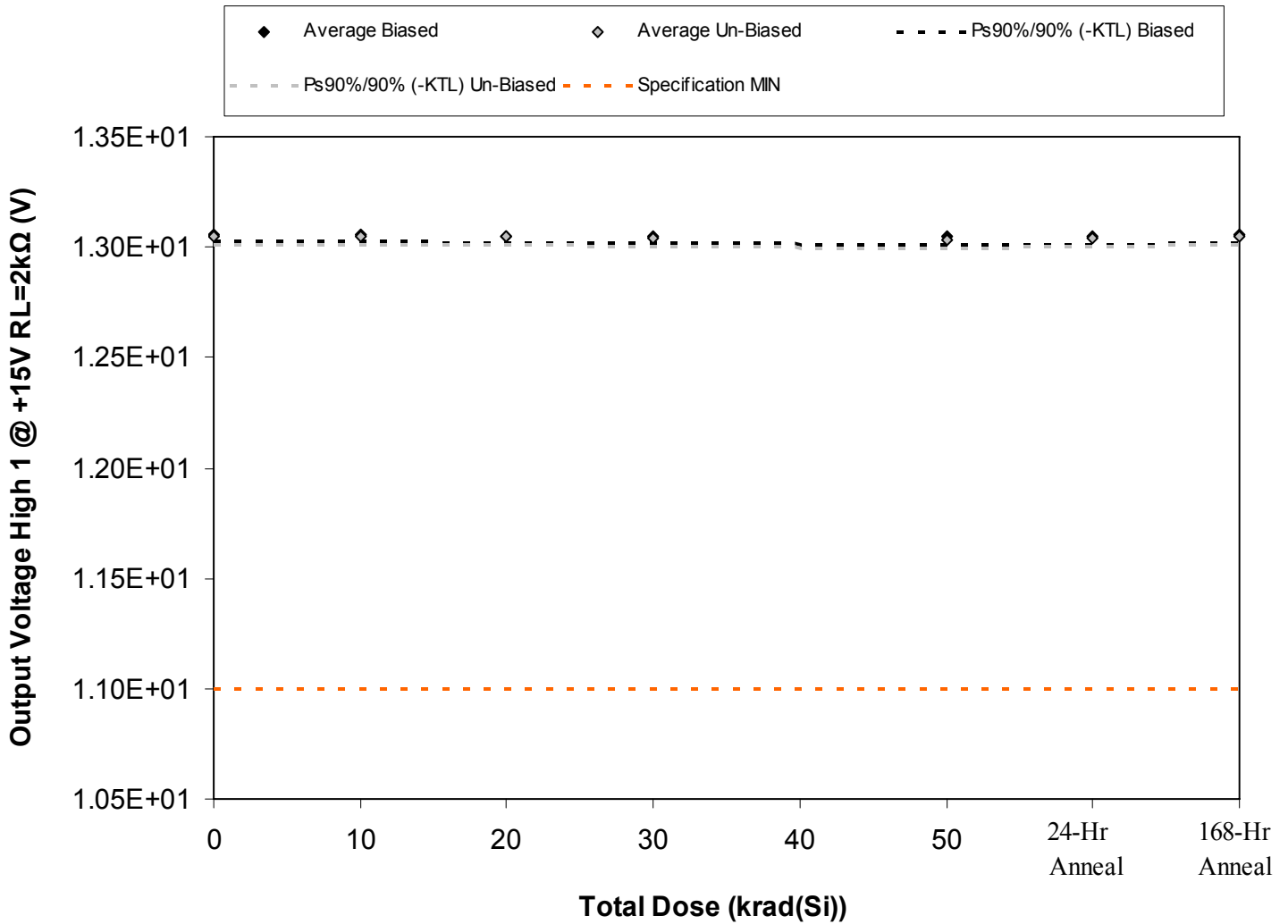

Figure 5.53. Plot of Output Voltage High 1 @ +15V RL=2kΩ (V) versus total dose. The solid diamonds are the average of the measured data points for the samples irradiated under electrical bias while the shaded diamonds are the average of the measured data points for the samples irradiated with all pins tied to ground. The black lines (solid and/or dashed) are the average of the data points after application of the KTL statistics on the samples irradiated under electrical bias while the gray lines (solid and/or dashed) are the average of the data points after application of the KTL statistics on the samples irradiated in the unbiased condition. The red dotted line(s) are the pre- and/or post-irradiation minimum and/or maximum specification value as defined in the datasheet and/or test plan.





Table 5.53. Raw data for Output Voltage High 1 @ +15V RL=2kΩ (V) versus total dose, including the statistical analysis, specification and the status of the testing (pass/fail).

Output Voltage High 1 @ +15V RL=2kΩ (V)	Total Dose (krad(Si))					24 hr Anneal	168 hr Anneal
	0	10	20	30	50		
Device							
255	1.30E+01	1.30E+01	1.30E+01	1.30E+01	1.30E+01	1.30E+01	1.30E+01
258	1.31E+01	1.31E+01	1.31E+01	1.31E+01	1.31E+01	1.31E+01	1.31E+01
309	1.31E+01	1.31E+01	1.31E+01	1.31E+01	1.31E+01	1.31E+01	1.31E+01
359	1.31E+01	1.31E+01	1.31E+01	1.31E+01	1.31E+01	1.31E+01	1.31E+01
360	1.31E+01	1.30E+01	1.30E+01	1.30E+01	1.30E+01	1.30E+01	1.30E+01
416	1.30E+01	1.30E+01	1.30E+01	1.30E+01	1.30E+01	1.30E+01	1.30E+01
472	1.31E+01	1.30E+01	1.30E+01	1.30E+01	1.30E+01	1.30E+01	1.30E+01
473	1.31E+01	1.31E+01	1.31E+01	1.31E+01	1.30E+01	1.30E+01	1.31E+01
526	1.31E+01	1.31E+01	1.31E+01	1.31E+01	1.31E+01	1.31E+01	1.31E+01
529	1.30E+01	1.30E+01	1.30E+01	1.30E+01	1.30E+01	1.30E+01	1.30E+01
530	1.31E+01	1.31E+01	1.31E+01	1.31E+01	1.31E+01	1.31E+01	1.31E+01
561	1.30E+01	1.30E+01	1.30E+01	1.30E+01	1.30E+01	1.30E+01	1.30E+01
<b>Biased Statistics</b>							
Average Biased	1.31E+01	1.31E+01	1.31E+01	1.31E+01	1.30E+01	1.30E+01	1.31E+01
Std Dev Biased	1.24E-02	1.18E-02	1.25E-02	1.27E-02	1.38E-02	1.28E-02	1.26E-02
Ps90%/90% (+KTL) Biased	1.31E+01	1.31E+01	1.31E+01	1.31E+01	1.31E+01	1.31E+01	1.31E+01
Ps90%/90% (-KTL) Biased	1.30E+01	1.30E+01	1.30E+01	1.30E+01	1.30E+01	1.30E+01	1.30E+01
<b>Un-Biased Statistics</b>							
Average Un-Biased	1.31E+01	1.30E+01	1.30E+01	1.30E+01	1.30E+01	1.30E+01	1.30E+01
Std Dev Un-Biased	1.41E-02	1.47E-02	1.38E-02	1.48E-02	1.43E-02	1.45E-02	1.48E-02
Ps90%/90% (+KTL) Un-Biased	1.31E+01	1.31E+01	1.31E+01	1.31E+01	1.31E+01	1.31E+01	1.31E+01
Ps90%/90% (-KTL) Un-Biased	1.30E+01	1.30E+01	1.30E+01	1.30E+01	1.30E+01	1.30E+01	1.30E+01
<b>Specification MIN</b>	<b>1.10E+01</b>	<b>1.10E+01</b>	<b>1.10E+01</b>	<b>1.10E+01</b>	<b>1.10E+01</b>	<b>1.10E+01</b>	<b>1.10E+01</b>
Status	PASS	PASS	PASS	PASS	PASS	PASS	PASS

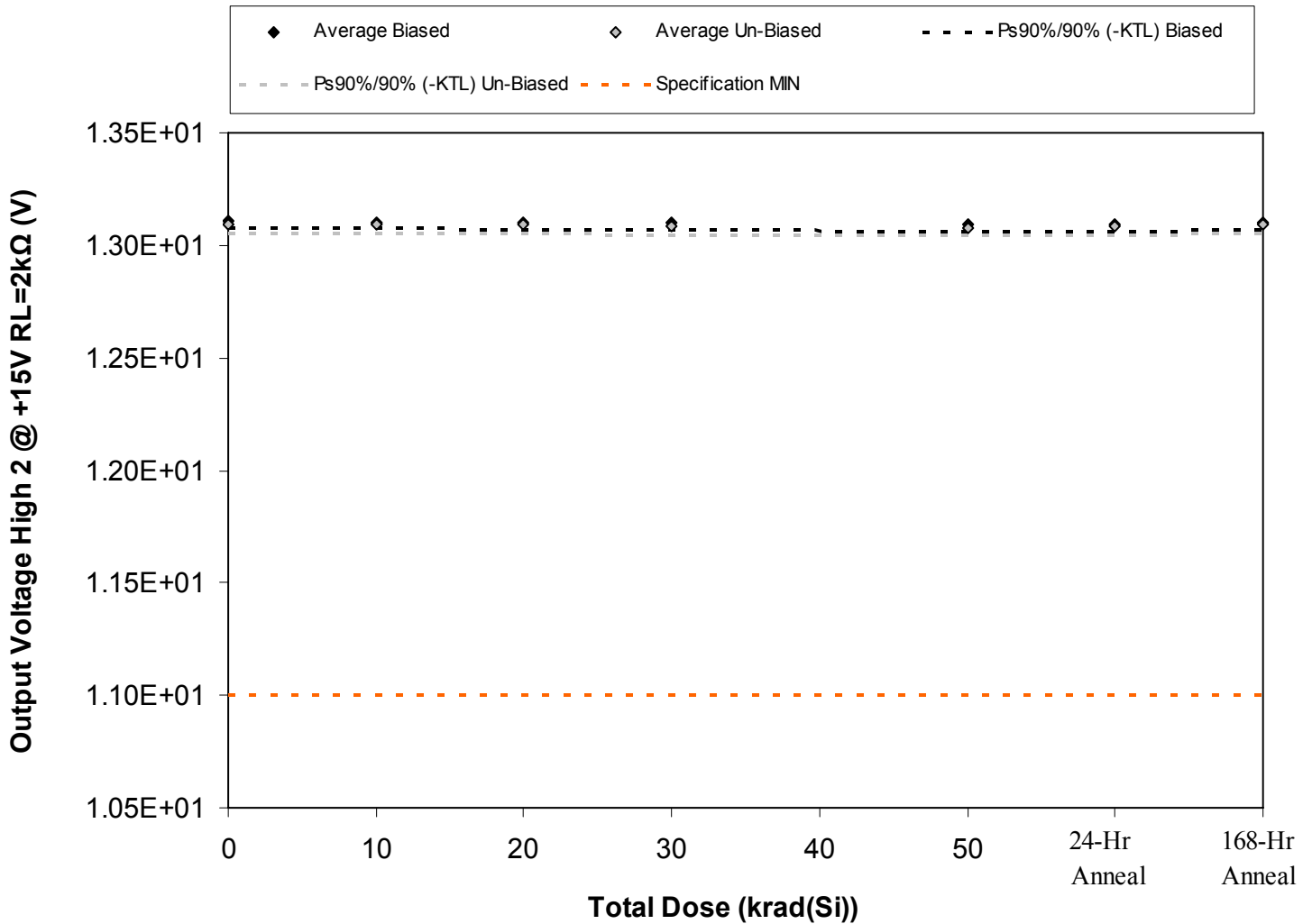

Figure 5.54. Plot of Output Voltage High 2 @ +15V RL=2kΩ (V) versus total dose. The solid diamonds are the average of the measured data points for the samples irradiated under electrical bias while the shaded diamonds are the average of the measured data points for the samples irradiated with all pins tied to ground. The black lines (solid and/or dashed) are the average of the data points after application of the KTL statistics on the samples irradiated under electrical bias while the gray lines (solid and/or dashed) are the average of the data points after application of the KTL statistics on the samples irradiated in the unbiased condition. The red dotted line(s) are the pre- and/or post-irradiation minimum and/or maximum specification value as defined in the datasheet and/or test plan.



Table 5.54. Raw data for Output Voltage High 2 @ +15V RL=2kΩ (V) versus total dose, including the statistical analysis, specification and the status of the testing (pass/fail).

Output Voltage High 2 @ +15V RL=2kΩ (V)	Total Dose (krad(Si))					24 hr Anneal	168 hr Anneal
	0	10	20	30	50		
Device							
255	1.31E+01	1.31E+01	1.31E+01	1.31E+01	1.31E+01	1.31E+01	1.31E+01
258	1.31E+01	1.31E+01	1.31E+01	1.31E+01	1.31E+01	1.31E+01	1.31E+01
309	1.31E+01	1.31E+01	1.31E+01	1.31E+01	1.31E+01	1.31E+01	1.31E+01
359	1.31E+01	1.31E+01	1.31E+01	1.31E+01	1.31E+01	1.31E+01	1.31E+01
360	1.31E+01	1.31E+01	1.31E+01	1.31E+01	1.31E+01	1.31E+01	1.31E+01
416	1.31E+01	1.31E+01	1.31E+01	1.31E+01	1.31E+01	1.31E+01	1.31E+01
472	1.31E+01	1.31E+01	1.31E+01	1.31E+01	1.31E+01	1.31E+01	1.31E+01
473	1.31E+01	1.31E+01	1.31E+01	1.31E+01	1.31E+01	1.31E+01	1.31E+01
526	1.31E+01	1.31E+01	1.31E+01	1.31E+01	1.31E+01	1.31E+01	1.31E+01
529	1.31E+01	1.31E+01	1.31E+01	1.31E+01	1.31E+01	1.31E+01	1.31E+01
530	1.31E+01	1.31E+01	1.31E+01	1.31E+01	1.31E+01	1.31E+01	1.31E+01
561	1.31E+01	1.31E+01	1.31E+01	1.31E+01	1.31E+01	1.31E+01	1.31E+01
<b>Biased Statistics</b>							
Average Biased	1.31E+01	1.31E+01	1.31E+01	1.31E+01	1.31E+01	1.31E+01	1.31E+01
Std Dev Biased	1.07E-02	1.09E-02	1.14E-02	1.12E-02	1.22E-02	1.20E-02	1.16E-02
Ps90%/90% (+KTL) Biased	1.31E+01	1.31E+01	1.31E+01	1.31E+01	1.31E+01	1.31E+01	1.31E+01
Ps90%/90% (-KTL) Biased	1.31E+01	1.31E+01	1.31E+01	1.31E+01	1.31E+01	1.31E+01	1.31E+01
<b>Un-Biased Statistics</b>							
Average Un-Biased	1.31E+01	1.31E+01	1.31E+01	1.31E+01	1.31E+01	1.31E+01	1.31E+01
Std Dev Un-Biased	1.41E-02	1.40E-02	1.26E-02	1.36E-02	1.40E-02	1.41E-02	1.39E-02
Ps90%/90% (+KTL) Un-Biased	1.31E+01	1.31E+01	1.31E+01	1.31E+01	1.31E+01	1.31E+01	1.31E+01
Ps90%/90% (-KTL) Un-Biased	1.31E+01	1.31E+01	1.31E+01	1.30E+01	1.30E+01	1.30E+01	1.31E+01
<b>Specification MIN</b>	<b>1.10E+01</b>	<b>1.10E+01</b>	<b>1.10E+01</b>	<b>1.10E+01</b>	<b>1.10E+01</b>	<b>1.10E+01</b>	<b>1.10E+01</b>
Status	PASS	PASS	PASS	PASS	PASS	PASS	PASS

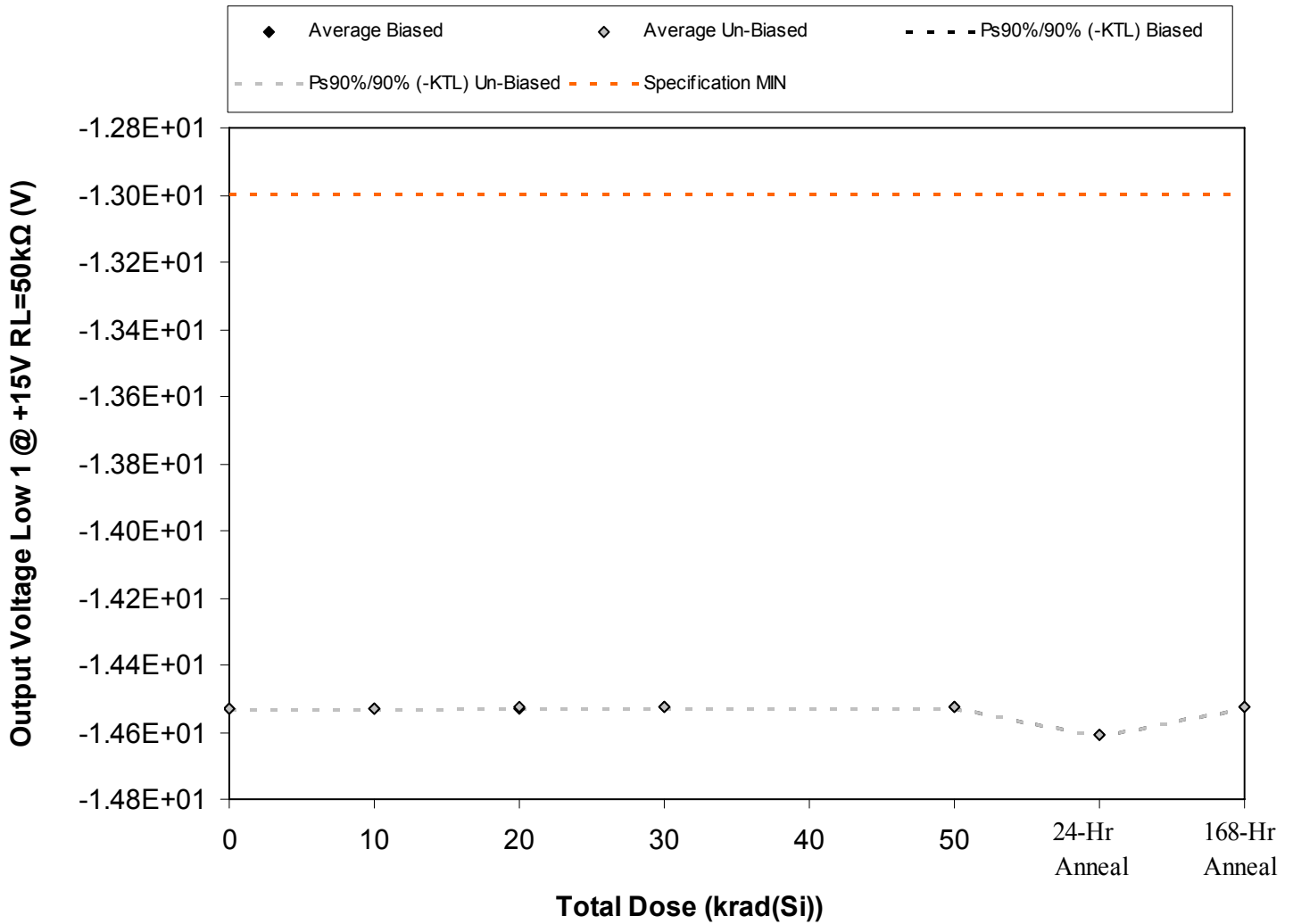

Figure 5.55. Plot of Output Voltage Low 1 @ +15V RL=50kΩ (V) versus total dose. The solid diamonds are the average of the measured data points for the samples irradiated under electrical bias while the shaded diamonds are the average of the measured data points for the samples irradiated with all pins tied to ground. The black lines (solid and/or dashed) are the average of the data points after application of the KTL statistics on the samples irradiated under electrical bias while the gray lines (solid and/or dashed) are the average of the data points after application of the KTL statistics on the samples irradiated in the unbiased condition. The red dotted line(s) are the pre- and/or post-irradiation minimum and/or maximum specification value as defined in the datasheet and/or test plan.



Table 5.55. Raw data for Output Voltage Low 1 @ +15V RL=50kΩ (V) versus total dose, including the statistical analysis, specification and the status of the testing (pass/fail).

Output Voltage Low 1 @ +15V RL=50kΩ (V)	Total Dose (krad(Si))					24 hr Anneal	168 hr Anneal
	0	10	20	30	50		
Device							
255	-1.45E+01	-1.45E+01	-1.45E+01	-1.45E+01	-1.45E+01	-1.46E+01	-1.45E+01
258	-1.45E+01	-1.45E+01	-1.45E+01	-1.45E+01	-1.45E+01	-1.46E+01	-1.45E+01
309	-1.45E+01	-1.45E+01	-1.45E+01	-1.45E+01	-1.45E+01	-1.46E+01	-1.45E+01
359	-1.45E+01	-1.45E+01	-1.45E+01	-1.45E+01	-1.45E+01	-1.46E+01	-1.45E+01
360	-1.45E+01	-1.45E+01	-1.45E+01	-1.45E+01	-1.45E+01	-1.46E+01	-1.45E+01
416	-1.45E+01	-1.45E+01	-1.45E+01	-1.45E+01	-1.45E+01	-1.46E+01	-1.45E+01
472	-1.45E+01	-1.45E+01	-1.45E+01	-1.45E+01	-1.45E+01	-1.46E+01	-1.45E+01
473	-1.45E+01	-1.45E+01	-1.45E+01	-1.45E+01	-1.45E+01	-1.46E+01	-1.45E+01
526	-1.45E+01	-1.45E+01	-1.45E+01	-1.45E+01	-1.45E+01	-1.46E+01	-1.45E+01
529	-1.45E+01	-1.45E+01	-1.45E+01	-1.45E+01	-1.45E+01	-1.46E+01	-1.45E+01
530	-1.45E+01	-1.45E+01	-1.45E+01	-1.45E+01	-1.45E+01	-1.46E+01	-1.45E+01
561	-1.45E+01	-1.45E+01	-1.45E+01	-1.45E+01	-1.45E+01	-1.46E+01	-1.45E+01
<b>Biased Statistics</b>							
Average Biased	-1.45E+01	-1.45E+01	-1.45E+01	-1.45E+01	-1.45E+01	-1.46E+01	-1.45E+01
Std Dev Biased	1.14E-03	1.79E-03	1.30E-03	1.41E-03	8.94E-04	1.22E-03	1.30E-03
Ps90%/90% (+KTL) Biased	-1.45E+01	-1.45E+01	-1.45E+01	-1.45E+01	-1.45E+01	-1.46E+01	-1.45E+01
Ps90%/90% (-KTL) Biased	-1.45E+01	-1.45E+01	-1.45E+01	-1.45E+01	-1.45E+01	-1.46E+01	-1.45E+01
<b>Un-Biased Statistics</b>							
Average Un-Biased	-1.45E+01	-1.45E+01	-1.45E+01	-1.45E+01	-1.45E+01	-1.46E+01	-1.45E+01
Std Dev Un-Biased	1.41E-03	1.67E-03	1.87E-03	1.30E-03	1.79E-03	1.87E-03	1.48E-03
Ps90%/90% (+KTL) Un-Biased	-1.45E+01	-1.45E+01	-1.45E+01	-1.45E+01	-1.45E+01	-1.46E+01	-1.45E+01
Ps90%/90% (-KTL) Un-Biased	-1.45E+01	-1.45E+01	-1.45E+01	-1.45E+01	-1.45E+01	-1.46E+01	-1.45E+01
<b>Specification MIN</b>	<b>-1.30E+01</b>	<b>-1.30E+01</b>	<b>-1.30E+01</b>	<b>-1.30E+01</b>	<b>-1.30E+01</b>	<b>-1.30E+01</b>	<b>-1.30E+01</b>
Status	PASS	PASS	PASS	PASS	PASS	PASS	PASS

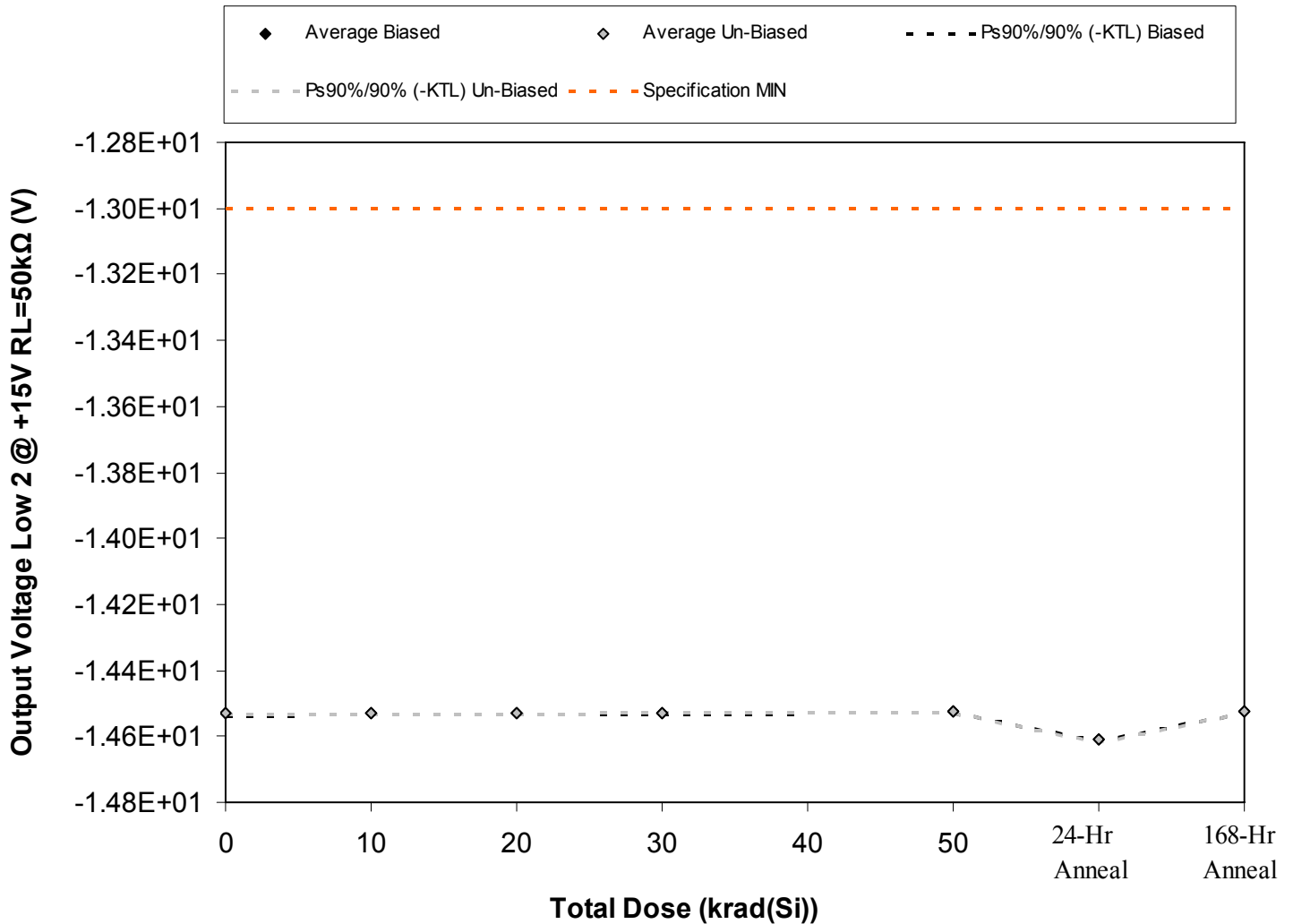

Figure 5.56. Plot of Output Voltage Low 2 @ +15V RL=50kΩ (V) versus total dose. The solid diamonds are the average of the measured data points for the samples irradiated under electrical bias while the shaded diamonds are the average of the measured data points for the samples irradiated with all pins tied to ground. The black lines (solid and/or dashed) are the average of the data points after application of the KTL statistics on the samples irradiated under electrical bias while the gray lines (solid and/or dashed) are the average of the data points after application of the KTL statistics on the samples irradiated in the unbiased condition. The red dotted line(s) are the pre- and/or post-irradiation minimum and/or maximum specification value as defined in the datasheet and/or test plan.



Table 5.56. Raw data for Output Voltage Low 2 @ +15V RL=50kΩ (V) versus total dose, including the statistical analysis, specification and the status of the testing (pass/fail).

Output Voltage Low 2 @ +15V RL=50kΩ (V)	Total Dose (krad(Si))					24 hr Anneal	168 hr Anneal
	0	10	20	30	50		
Device							
255	-1.45E+01	-1.45E+01	-1.45E+01	-1.45E+01	-1.45E+01	-1.46E+01	-1.45E+01
258	-1.45E+01	-1.45E+01	-1.45E+01	-1.45E+01	-1.45E+01	-1.46E+01	-1.45E+01
309	-1.45E+01	-1.45E+01	-1.45E+01	-1.45E+01	-1.45E+01	-1.46E+01	-1.45E+01
359	-1.45E+01	-1.45E+01	-1.45E+01	-1.45E+01	-1.45E+01	-1.46E+01	-1.45E+01
360	-1.45E+01	-1.45E+01	-1.45E+01	-1.45E+01	-1.45E+01	-1.46E+01	-1.45E+01
416	-1.45E+01	-1.45E+01	-1.45E+01	-1.45E+01	-1.45E+01	-1.46E+01	-1.45E+01
472	-1.45E+01	-1.45E+01	-1.45E+01	-1.45E+01	-1.45E+01	-1.46E+01	-1.45E+01
473	-1.45E+01	-1.45E+01	-1.45E+01	-1.45E+01	-1.45E+01	-1.46E+01	-1.45E+01
526	-1.45E+01	-1.45E+01	-1.45E+01	-1.45E+01	-1.45E+01	-1.46E+01	-1.45E+01
529	-1.45E+01	-1.45E+01	-1.45E+01	-1.45E+01	-1.45E+01	-1.46E+01	-1.45E+01
530	-1.45E+01	-1.45E+01	-1.45E+01	-1.45E+01	-1.45E+01	-1.46E+01	-1.45E+01
561	-1.45E+01	-1.45E+01	-1.45E+01	-1.45E+01	-1.45E+01	-1.46E+01	-1.45E+01
<b>Biased Statistics</b>							
Average Biased	-1.45E+01	-1.45E+01	-1.45E+01	-1.45E+01	-1.45E+01	-1.46E+01	-1.45E+01
Std Dev Biased	3.08E-03	2.88E-03	2.61E-03	2.12E-03	2.30E-03	2.12E-03	2.28E-03
Ps90%/90% (+KTL) Biased	-1.45E+01	-1.45E+01	-1.45E+01	-1.45E+01	-1.45E+01	-1.46E+01	-1.45E+01
Ps90%/90% (-KTL) Biased	-1.45E+01	-1.45E+01	-1.45E+01	-1.45E+01	-1.45E+01	-1.46E+01	-1.45E+01
<b>Un-Biased Statistics</b>							
Average Un-Biased	-1.45E+01	-1.45E+01	-1.45E+01	-1.45E+01	-1.45E+01	-1.46E+01	-1.45E+01
Std Dev Un-Biased	1.64E-03	1.73E-03	2.19E-03	1.52E-03	1.64E-03	2.07E-03	1.34E-03
Ps90%/90% (+KTL) Un-Biased	-1.45E+01	-1.45E+01	-1.45E+01	-1.45E+01	-1.45E+01	-1.46E+01	-1.45E+01
Ps90%/90% (-KTL) Un-Biased	-1.45E+01	-1.45E+01	-1.45E+01	-1.45E+01	-1.45E+01	-1.46E+01	-1.45E+01
<b>Specification MIN</b>	<b>-1.30E+01</b>	<b>-1.30E+01</b>	<b>-1.30E+01</b>	<b>-1.30E+01</b>	<b>-1.30E+01</b>	<b>-1.30E+01</b>	<b>-1.30E+01</b>
Status	PASS	PASS	PASS	PASS	PASS	PASS	PASS

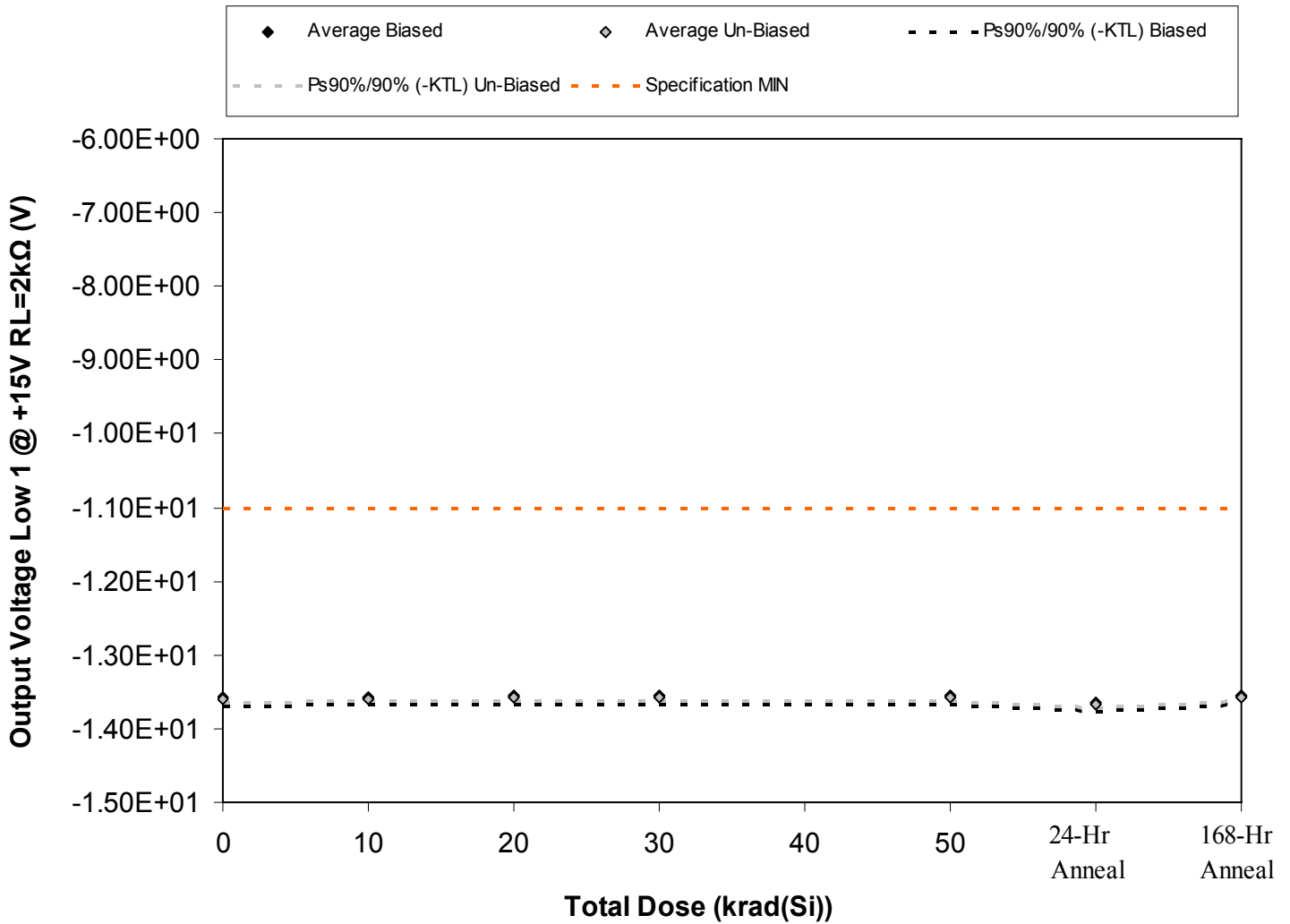

Figure 5.57. Plot of Output Voltage Low 1 @ +15V RL=2kΩ (V) versus total dose. The solid diamonds are the average of the measured data points for the samples irradiated under electrical bias while the shaded diamonds are the average of the measured data points for the samples irradiated with all pins tied to ground. The black lines (solid and/or dashed) are the average of the data points after application of the KTL statistics on the samples irradiated under electrical bias while the gray lines (solid and/or dashed) are the average of the data points after application of the KTL statistics on the samples irradiated in the unbiased condition. The red dotted line(s) are the pre- and/or post-irradiation minimum and/or maximum specification value as defined in the datasheet and/or test plan.





Table 5.57. Raw data for Output Voltage Low 1 @ +15V RL=2kΩ (V) versus total dose, including the statistical analysis, specification and the status of the testing (pass/fail).

Output Voltage Low 1 @ +15V RL=2kΩ (V)	Total Dose (krad(Si))					24 hr Anneal	168 hr Anneal
	0	10	20	30	50		
Device							
255	-1.36E+01	-1.36E+01	-1.36E+01	-1.36E+01	-1.36E+01	-1.37E+01	-1.36E+01
258	-1.35E+01	-1.35E+01	-1.35E+01	-1.35E+01	-1.35E+01	-1.36E+01	-1.35E+01
309	-1.36E+01	-1.36E+01	-1.36E+01	-1.36E+01	-1.35E+01	-1.36E+01	-1.35E+01
359	-1.35E+01	-1.35E+01	-1.35E+01	-1.35E+01	-1.35E+01	-1.36E+01	-1.35E+01
360	-1.36E+01	-1.36E+01	-1.36E+01	-1.36E+01	-1.36E+01	-1.37E+01	-1.36E+01
416	-1.36E+01	-1.36E+01	-1.36E+01	-1.36E+01	-1.36E+01	-1.36E+01	-1.36E+01
472	-1.36E+01	-1.36E+01	-1.36E+01	-1.36E+01	-1.36E+01	-1.37E+01	-1.36E+01
473	-1.36E+01	-1.36E+01	-1.36E+01	-1.36E+01	-1.36E+01	-1.37E+01	-1.36E+01
526	-1.36E+01	-1.36E+01	-1.36E+01	-1.36E+01	-1.36E+01	-1.37E+01	-1.36E+01
529	-1.36E+01	-1.36E+01	-1.36E+01	-1.36E+01	-1.36E+01	-1.37E+01	-1.36E+01
530	-1.36E+01	-1.36E+01	-1.36E+01	-1.36E+01	-1.36E+01	-1.37E+01	-1.36E+01
561	-1.36E+01	-1.36E+01	-1.36E+01	-1.36E+01	-1.36E+01	-1.37E+01	-1.36E+01
<b>Biased Statistics</b>							
Average Biased	-1.36E+01	-1.36E+01	-1.36E+01	-1.36E+01	-1.36E+01	-1.36E+01	-1.36E+01
Std Dev Biased	3.98E-02	4.14E-02	4.08E-02	4.16E-02	4.14E-02	4.13E-02	4.10E-02
Ps90%/90% (+KTL) Biased	-1.35E+01	-1.35E+01	-1.34E+01	-1.34E+01	-1.34E+01	-1.35E+01	-1.34E+01
Ps90%/90% (-KTL) Biased	-1.37E+01	-1.37E+01	-1.37E+01	-1.37E+01	-1.37E+01	-1.38E+01	-1.37E+01
<b>Un-Biased Statistics</b>							
Average Un-Biased	-1.36E+01	-1.36E+01	-1.36E+01	-1.36E+01	-1.36E+01	-1.37E+01	-1.36E+01
Std Dev Un-Biased	1.41E-02	1.46E-02	1.70E-02	1.39E-02	1.49E-02	1.46E-02	1.42E-02
Ps90%/90% (+KTL) Un-Biased	-1.36E+01	-1.35E+01	-1.35E+01	-1.35E+01	-1.35E+01	-1.36E+01	-1.35E+01
Ps90%/90% (-KTL) Un-Biased	-1.36E+01	-1.36E+01	-1.36E+01	-1.36E+01	-1.36E+01	-1.37E+01	-1.36E+01
<b>Specification MIN</b>	<b>-1.10E+01</b>	<b>-1.10E+01</b>	<b>-1.10E+01</b>	<b>-1.10E+01</b>	<b>-1.10E+01</b>	<b>-1.10E+01</b>	<b>-1.10E+01</b>
Status	PASS	PASS	PASS	PASS	PASS	PASS	PASS

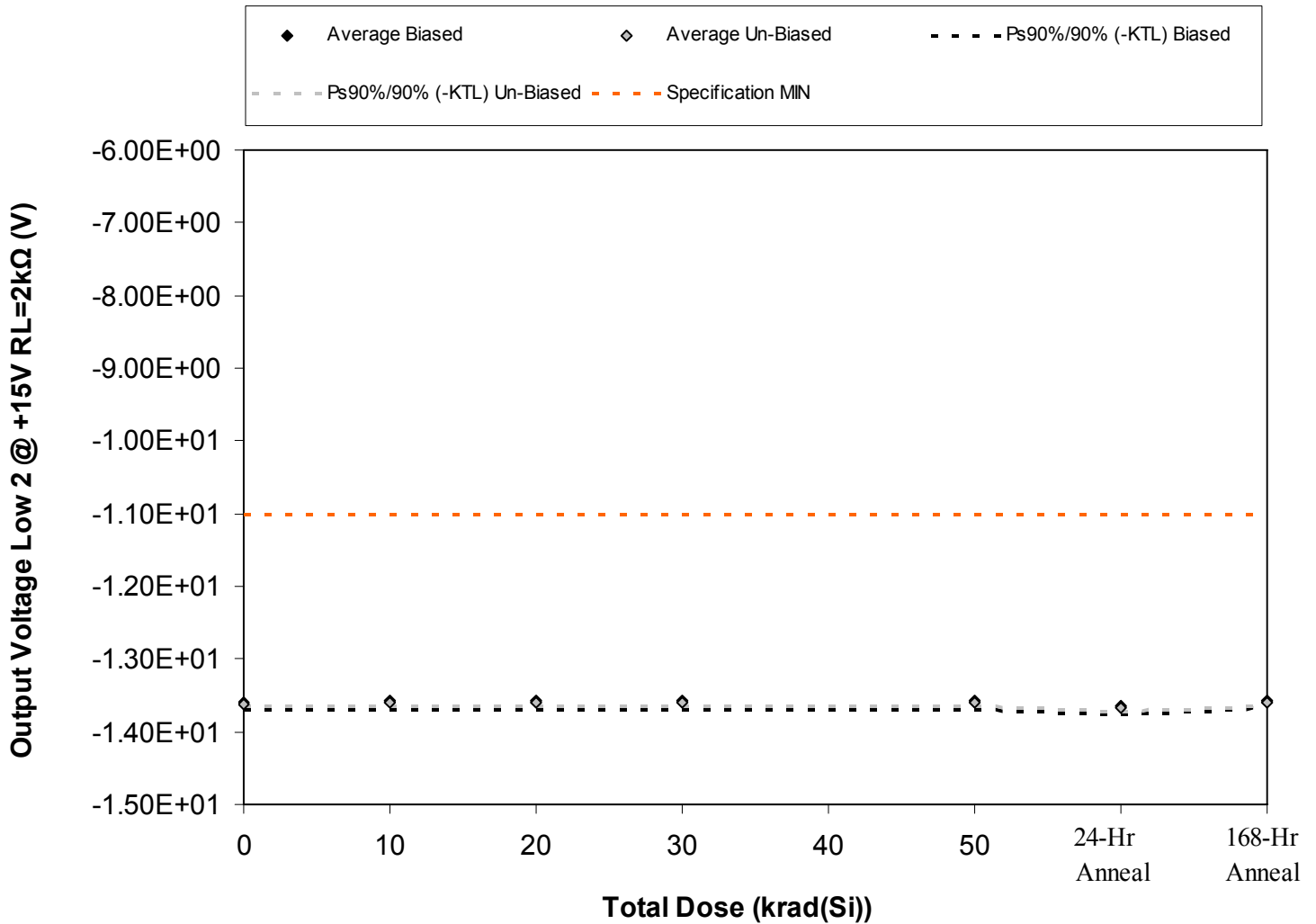

Figure 5.58. Plot of Output Voltage Low 2 @ +15V RL=2kΩ (V) versus total dose. The solid diamonds are the average of the measured data points for the samples irradiated under electrical bias while the shaded diamonds are the average of the measured data points for the samples irradiated with all pins tied to ground. The black lines (solid and/or dashed) are the average of the data points after application of the KTL statistics on the samples irradiated under electrical bias while the gray lines (solid and/or dashed) are the average of the data points after application of the KTL statistics on the samples irradiated in the unbiased condition. The red dotted line(s) are the pre- and/or post-irradiation minimum and/or maximum specification value as defined in the datasheet and/or test plan.



**TID Report  
10-004 100412 R1.0**

**Radiation Assured Devices  
5017 N. 30th Street  
Colorado Springs, CO 80919  
(719) 531-0800**

Table 5.58. Raw data for Output Voltage Low 2 @ +15V RL=2kΩ (V) versus total dose, including the statistical analysis, specification and the status of the testing (pass/fail).

Output Voltage Low 2 @ +15V RL=2kΩ (V)	Total Dose (krad(Si))					24 hr Anneal	168 hr Anneal
	0	10	20	30	50		
Device							
255	-1.36E+01	-1.36E+01	-1.36E+01	-1.36E+01	-1.36E+01	-1.37E+01	-1.36E+01
258	-1.36E+01	-1.35E+01	-1.35E+01	-1.35E+01	-1.35E+01	-1.36E+01	-1.35E+01
309	-1.36E+01	-1.36E+01	-1.36E+01	-1.36E+01	-1.36E+01	-1.36E+01	-1.36E+01
359	-1.36E+01	-1.35E+01	-1.35E+01	-1.35E+01	-1.35E+01	-1.36E+01	-1.35E+01
360	-1.36E+01	-1.36E+01	-1.36E+01	-1.36E+01	-1.36E+01	-1.37E+01	-1.36E+01
416	-1.36E+01	-1.36E+01	-1.36E+01	-1.36E+01	-1.36E+01	-1.37E+01	-1.36E+01
472	-1.36E+01	-1.36E+01	-1.36E+01	-1.36E+01	-1.36E+01	-1.37E+01	-1.36E+01
473	-1.36E+01	-1.36E+01	-1.36E+01	-1.36E+01	-1.36E+01	-1.37E+01	-1.36E+01
526	-1.36E+01	-1.36E+01	-1.36E+01	-1.36E+01	-1.36E+01	-1.37E+01	-1.36E+01
529	-1.36E+01	-1.36E+01	-1.36E+01	-1.36E+01	-1.36E+01	-1.37E+01	-1.36E+01
530	-1.36E+01	-1.36E+01	-1.36E+01	-1.36E+01	-1.36E+01	-1.37E+01	-1.36E+01
561	-1.36E+01	-1.36E+01	-1.36E+01	-1.36E+01	-1.36E+01	-1.37E+01	-1.36E+01
<b>Biased Statistics</b>							
Average Biased	-1.36E+01	-1.36E+01	-1.36E+01	-1.36E+01	-1.36E+01	-1.37E+01	-1.36E+01
Std Dev Biased	3.95E-02	4.11E-02	4.01E-02	4.15E-02	4.11E-02	4.04E-02	4.05E-02
Ps90%/90% (+KTL) Biased	-1.35E+01	-1.35E+01	-1.35E+01	-1.35E+01	-1.35E+01	-1.35E+01	-1.35E+01
Ps90%/90% (-KTL) Biased	-1.37E+01	-1.37E+01	-1.37E+01	-1.37E+01	-1.37E+01	-1.38E+01	-1.37E+01
<b>Un-Biased Statistics</b>							
Average Un-Biased	-1.36E+01	-1.36E+01	-1.36E+01	-1.36E+01	-1.36E+01	-1.37E+01	-1.36E+01
Std Dev Un-Biased	1.55E-02	1.52E-02	1.77E-02	1.53E-02	1.56E-02	1.53E-02	1.56E-02
Ps90%/90% (+KTL) Un-Biased	-1.36E+01	-1.36E+01	-1.35E+01	-1.36E+01	-1.36E+01	-1.36E+01	-1.36E+01
Ps90%/90% (-KTL) Un-Biased	-1.37E+01	-1.36E+01	-1.36E+01	-1.36E+01	-1.36E+01	-1.37E+01	-1.36E+01
<b>Specification MIN</b>	<b>-1.10E+01</b>	<b>-1.10E+01</b>	<b>-1.10E+01</b>	<b>-1.10E+01</b>	<b>-1.10E+01</b>	<b>-1.10E+01</b>	<b>-1.10E+01</b>
Status	PASS	PASS	PASS	PASS	PASS	PASS	PASS

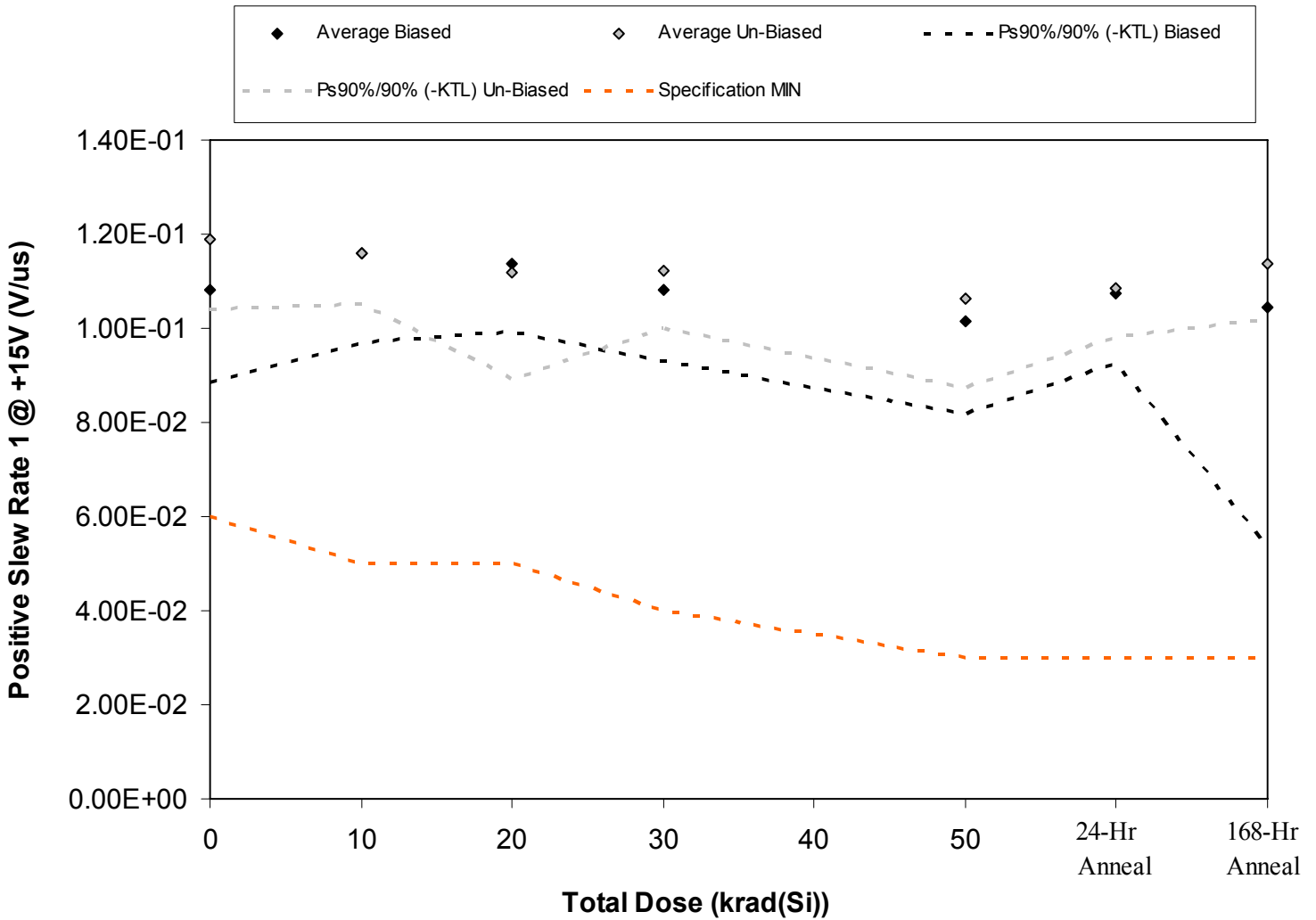

Figure 5.59. Plot of Positive Slew Rate 1 @ +15V (V/us) versus total dose. The solid diamonds are the average of the measured data points for the samples irradiated under electrical bias while the shaded diamonds are the average of the measured data points for the samples irradiated with all pins tied to ground. The black lines (solid and/or dashed) are the average of the data points after application of the KTL statistics on the samples irradiated under electrical bias while the gray lines (solid and/or dashed) are the average of the data points after application of the KTL statistics on the samples irradiated in the unbiased condition. The red dotted line(s) are the pre- and/or post-irradiation minimum and/or maximum specification value as defined in the datasheet and/or test plan.



Table 5.59. Raw data for Positive Slew Rate 1 @ +15V (V/us) versus total dose, including the statistical analysis, specification and the status of the testing (pass/fail).

Positive Slew Rate 1 @ +15V (V/us)	Total Dose (krad(Si))					24 hr Anneal	168 hr Anneal
	0	10	20	30	50		
Device	0	10	20	30	50		
255	1.13E-01	1.09E-01	1.11E-01	1.08E-01	1.03E-01	1.05E-01	7.20E-02
258	1.04E-01	1.26E-01	1.19E-01	1.14E-01	9.30E-02	1.10E-01	1.14E-01
309	9.80E-02	1.18E-01	1.15E-01	1.10E-01	1.08E-01	1.11E-01	1.15E-01
359	1.16E-01	1.17E-01	1.17E-01	9.90E-02	1.08E-01	1.12E-01	1.16E-01
360	1.10E-01	1.10E-01	1.06E-01	1.09E-01	9.50E-02	9.90E-02	1.05E-01
416	1.12E-01	1.11E-01	9.80E-02	1.09E-01	9.50E-02	1.04E-01	1.10E-01
472	1.24E-01	1.19E-01	1.15E-01	1.15E-01	1.13E-01	1.10E-01	1.18E-01
473	1.16E-01	1.13E-01	1.12E-01	1.06E-01	1.07E-01	1.09E-01	1.12E-01
526	1.18E-01	1.20E-01	1.20E-01	1.15E-01	1.11E-01	1.14E-01	1.19E-01
529	1.25E-01	1.16E-01	1.14E-01	1.16E-01	1.06E-01	1.06E-01	1.10E-01
530	1.22E-01	1.16E-01	1.18E-01	1.18E-01	1.24E-01	1.20E-01	1.18E-01
561	1.18E-01	9.90E-02	1.19E-01	1.18E-01	1.20E-01	1.16E-01	1.13E-01
<b>Biased Statistics</b>							
Average Biased	1.08E-01	1.16E-01	1.14E-01	1.08E-01	1.01E-01	1.07E-01	1.04E-01
Std Dev Biased	7.22E-03	6.89E-03	5.18E-03	5.52E-03	7.09E-03	5.41E-03	1.86E-02
Ps90%/90% (+KTL) Biased	1.28E-01	1.35E-01	1.28E-01	1.23E-01	1.21E-01	1.22E-01	1.55E-01
Ps90%/90% (-KTL) Biased	8.84E-02	9.71E-02	9.94E-02	9.29E-02	8.20E-02	9.26E-02	5.33E-02
<b>Un-Biased Statistics</b>							
Average Un-Biased	1.19E-01	1.16E-01	1.12E-01	1.12E-01	1.06E-01	1.09E-01	1.14E-01
Std Dev Un-Biased	5.48E-03	3.83E-03	8.26E-03	4.44E-03	6.99E-03	3.85E-03	4.38E-03
Ps90%/90% (+KTL) Un-Biased	1.34E-01	1.26E-01	1.34E-01	1.24E-01	1.26E-01	1.19E-01	1.26E-01
Ps90%/90% (-KTL) Un-Biased	1.04E-01	1.05E-01	8.92E-02	1.00E-01	8.72E-02	9.81E-02	1.02E-01
<b>Specification MIN</b>	<b>6.00E-02</b>	<b>5.00E-02</b>	<b>5.00E-02</b>	<b>4.00E-02</b>	<b>3.00E-02</b>	<b>3.00E-02</b>	<b>3.00E-02</b>
Status	PASS	PASS	PASS	PASS	PASS	PASS	PASS

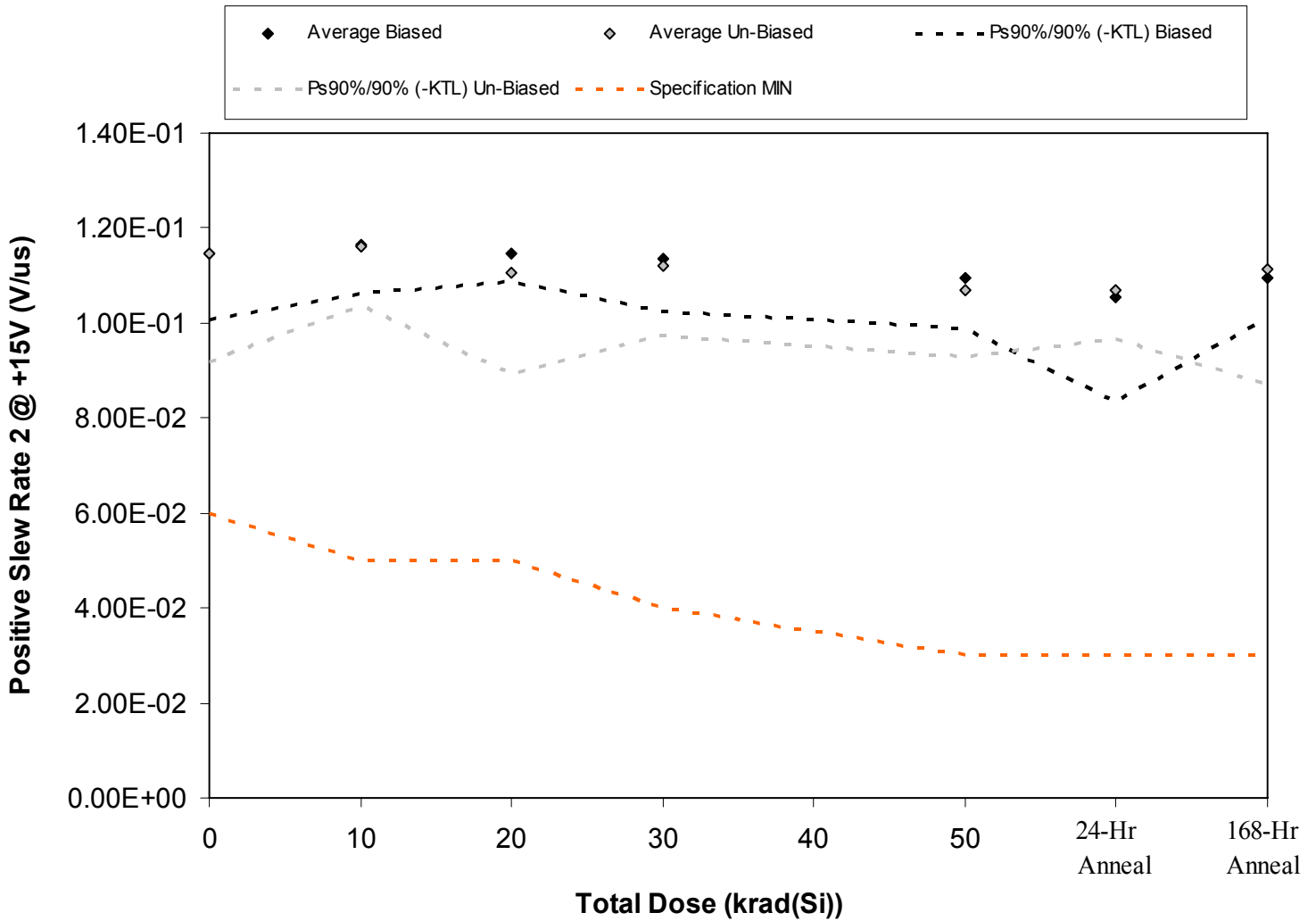

Figure 5.60. Plot of Positive Slew Rate 2 @ +15V (V/us) versus total dose. The solid diamonds are the average of the measured data points for the samples irradiated under electrical bias while the shaded diamonds are the average of the measured data points for the samples irradiated with all pins tied to ground. The black lines (solid and/or dashed) are the average of the data points after application of the KTL statistics on the samples irradiated under electrical bias while the gray lines (solid and/or dashed) are the average of the data points after application of the KTL statistics on the samples irradiated in the unbiased condition. The red dotted line(s) are the pre- and/or post-irradiation minimum and/or maximum specification value as defined in the datasheet and/or test plan.



Table 5.60. Raw data for Positive Slew Rate 2 @ +15V (V/us) versus total dose, including the statistical analysis, specification and the status of the testing (pass/fail).

Positive Slew Rate 2 @ +15V (V/us)	Total Dose (krad(Si))					24 hr Anneal	168 hr Anneal
	0	10	20	30	50		
Device							
255	1.09E-01	1.13E-01	1.13E-01	1.10E-01	1.07E-01	9.30E-02	1.09E-01
258	1.22E-01	1.17E-01	1.15E-01	1.15E-01	1.13E-01	1.09E-01	1.09E-01
309	1.16E-01	1.22E-01	1.18E-01	1.15E-01	1.12E-01	1.10E-01	1.12E-01
359	1.15E-01	1.18E-01	1.14E-01	1.19E-01	1.12E-01	1.13E-01	1.13E-01
360	1.11E-01	1.13E-01	1.13E-01	1.09E-01	1.04E-01	1.02E-01	1.05E-01
416	1.14E-01	1.10E-01	9.70E-02	1.09E-01	9.80E-02	1.03E-01	9.70E-02
472	1.23E-01	1.18E-01	1.17E-01	1.19E-01	1.10E-01	1.11E-01	1.19E-01
473	1.01E-01	1.14E-01	1.12E-01	1.05E-01	1.08E-01	1.03E-01	1.16E-01
526	1.16E-01	1.22E-01	1.14E-01	1.14E-01	1.10E-01	1.10E-01	1.16E-01
529	1.19E-01	1.16E-01	1.13E-01	1.13E-01	1.09E-01	1.07E-01	1.09E-01
530	1.21E-01	1.03E-01	1.18E-01	1.18E-01	1.22E-01	1.22E-01	1.15E-01
561	1.15E-01	1.20E-01	1.14E-01	1.16E-01	1.16E-01	9.80E-02	1.21E-01
<b>Biased Statistics</b>							
Average Biased	1.15E-01	1.17E-01	1.15E-01	1.14E-01	1.10E-01	1.05E-01	1.10E-01
Std Dev Biased	5.03E-03	3.78E-03	2.07E-03	4.10E-03	3.91E-03	8.02E-03	3.13E-03
Ps90%/90% (+KTL) Biased	1.28E-01	1.27E-01	1.20E-01	1.25E-01	1.20E-01	1.27E-01	1.18E-01
Ps90%/90% (-KTL) Biased	1.01E-01	1.06E-01	1.09E-01	1.02E-01	9.89E-02	8.34E-02	1.01E-01
<b>Un-Biased Statistics</b>							
Average Un-Biased	1.15E-01	1.16E-01	1.11E-01	1.12E-01	1.07E-01	1.07E-01	1.11E-01
Std Dev Un-Biased	8.32E-03	4.47E-03	7.83E-03	5.29E-03	5.10E-03	3.77E-03	8.85E-03
Ps90%/90% (+KTL) Un-Biased	1.37E-01	1.28E-01	1.32E-01	1.27E-01	1.21E-01	1.17E-01	1.36E-01
Ps90%/90% (-KTL) Un-Biased	9.18E-02	1.04E-01	8.91E-02	9.75E-02	9.30E-02	9.65E-02	8.71E-02
<b>Specification MIN</b>	<b>6.00E-02</b>	<b>5.00E-02</b>	<b>5.00E-02</b>	<b>4.00E-02</b>	<b>3.00E-02</b>	<b>3.00E-02</b>	<b>3.00E-02</b>
Status	PASS	PASS	PASS	PASS	PASS	PASS	PASS

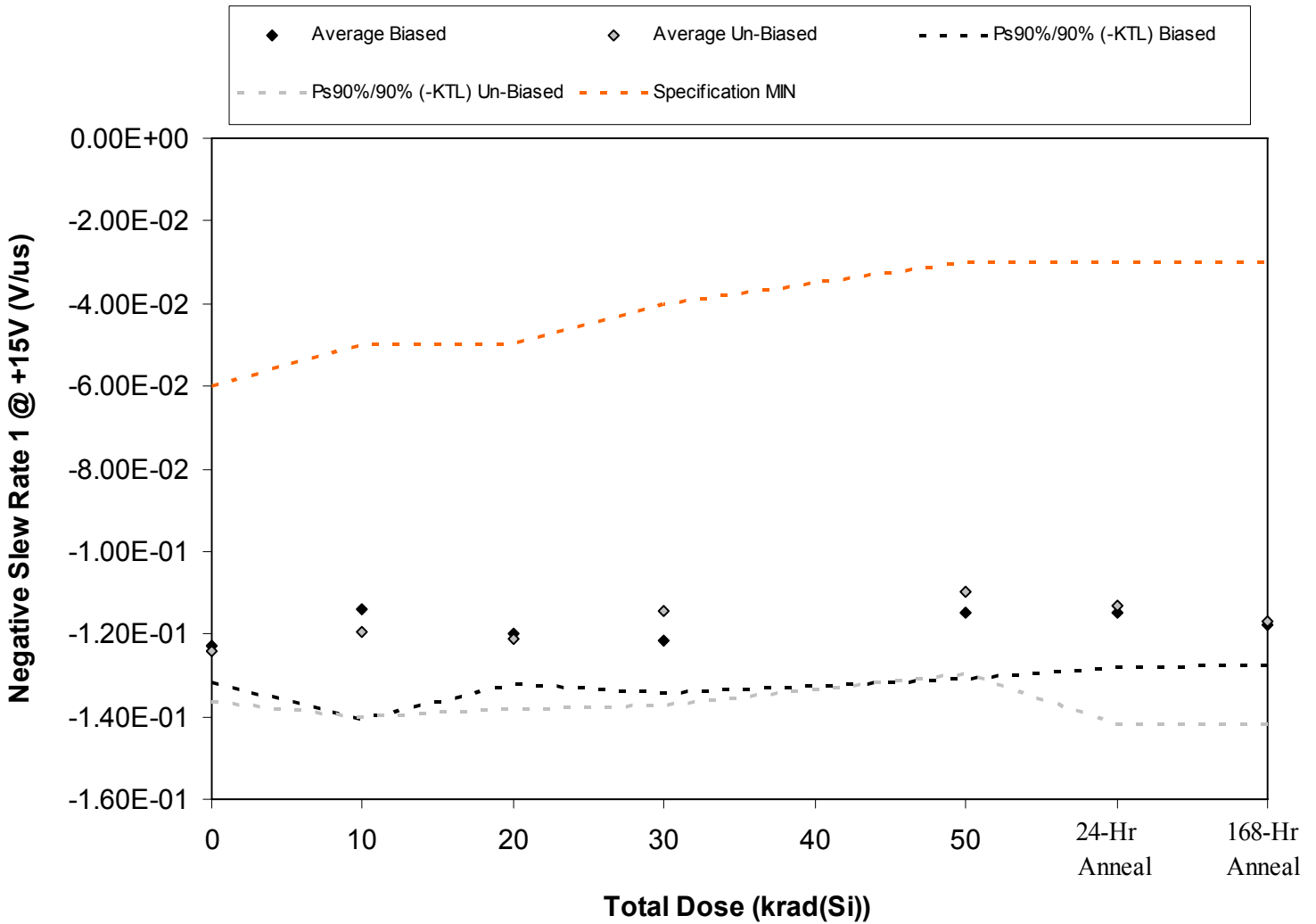

Figure 5.61. Plot of Negative Slew Rate 1 @ +15V (V/us) versus total dose. The solid diamonds are the average of the measured data points for the samples irradiated under electrical bias while the shaded diamonds are the average of the measured data points for the samples irradiated with all pins tied to ground. The black lines (solid and/or dashed) are the average of the data points after application of the KTL statistics on the samples irradiated under electrical bias while the gray lines (solid and/or dashed) are the average of the data points after application of the KTL statistics on the samples irradiated in the unbiased condition. The red dotted line(s) are the pre- and/or post-irradiation minimum and/or maximum specification value as defined in the datasheet and/or test plan.





Table 5.61. Raw data for Negative Slew Rate 1 @ +15V (V/us) versus total dose, including the statistical analysis, specification and the status of the testing (pass/fail).

Negative Slew Rate 1 @ +15V (V/us)	Total Dose (krad(Si))					24 hr Anneal	168 hr Anneal
	0	10	20	30	50		
Device							
255	-1.18E-01	-1.18E-01	-1.17E-01	-1.17E-01	-1.09E-01	-1.11E-01	-1.16E-01
258	-1.26E-01	-1.26E-01	-1.23E-01	-1.28E-01	-1.22E-01	-1.22E-01	-1.20E-01
309	-1.24E-01	-1.17E-01	-1.19E-01	-1.23E-01	-1.18E-01	-1.13E-01	-1.15E-01
359	-1.22E-01	-1.06E-01	-1.26E-01	-1.22E-01	-1.17E-01	-1.17E-01	-1.23E-01
360	-1.25E-01	-1.02E-01	-1.15E-01	-1.17E-01	-1.09E-01	-1.11E-01	-1.15E-01
416	-1.19E-01	-1.07E-01	-1.15E-01	-1.09E-01	-9.70E-02	-9.50E-02	-1.12E-01
472	-1.23E-01	-1.18E-01	-1.27E-01	-1.02E-01	-1.13E-01	-1.21E-01	-1.22E-01
473	-1.21E-01	-1.23E-01	-1.14E-01	-1.18E-01	-1.13E-01	-1.13E-01	-1.03E-01
526	-1.30E-01	-1.23E-01	-1.27E-01	-1.21E-01	-1.13E-01	-1.19E-01	-1.25E-01
529	-1.27E-01	-1.26E-01	-1.22E-01	-1.21E-01	-1.13E-01	-1.17E-01	-1.22E-01
530	-1.22E-01	-1.30E-01	-1.23E-01	-1.15E-01	-1.24E-01	-1.24E-01	-1.27E-01
561	-1.22E-01	-1.20E-01	-1.22E-01	-1.03E-01	-1.22E-01	-1.25E-01	-1.24E-01
<b>Biased Statistics</b>							
Average Biased	-1.23E-01	-1.14E-01	-1.20E-01	-1.21E-01	-1.15E-01	-1.15E-01	-1.18E-01
Std Dev Biased	3.16E-03	9.71E-03	4.47E-03	4.62E-03	5.79E-03	4.71E-03	3.56E-03
Ps90%/90% (+KTL) Biased	-1.14E-01	-8.72E-02	-1.08E-01	-1.09E-01	-9.91E-02	-1.02E-01	-1.08E-01
Ps90%/90% (-KTL) Biased	-1.32E-01	-1.40E-01	-1.32E-01	-1.34E-01	-1.31E-01	-1.28E-01	-1.28E-01
<b>Un-Biased Statistics</b>							
Average Un-Biased	-1.24E-01	-1.19E-01	-1.21E-01	-1.14E-01	-1.10E-01	-1.13E-01	-1.17E-01
Std Dev Un-Biased	4.47E-03	7.50E-03	6.28E-03	8.41E-03	7.16E-03	1.05E-02	9.15E-03
Ps90%/90% (+KTL) Un-Biased	-1.12E-01	-9.88E-02	-1.04E-01	-9.11E-02	-9.02E-02	-8.42E-02	-9.17E-02
Ps90%/90% (-KTL) Un-Biased	-1.36E-01	-1.40E-01	-1.38E-01	-1.37E-01	-1.29E-01	-1.42E-01	-1.42E-01
<b>Specification MIN</b>	<b>-6.00E-02</b>	<b>-5.00E-02</b>	<b>-5.00E-02</b>	<b>-4.00E-02</b>	<b>-3.00E-02</b>	<b>-3.00E-02</b>	<b>-3.00E-02</b>
Status	PASS	PASS	PASS	PASS	PASS	PASS	PASS

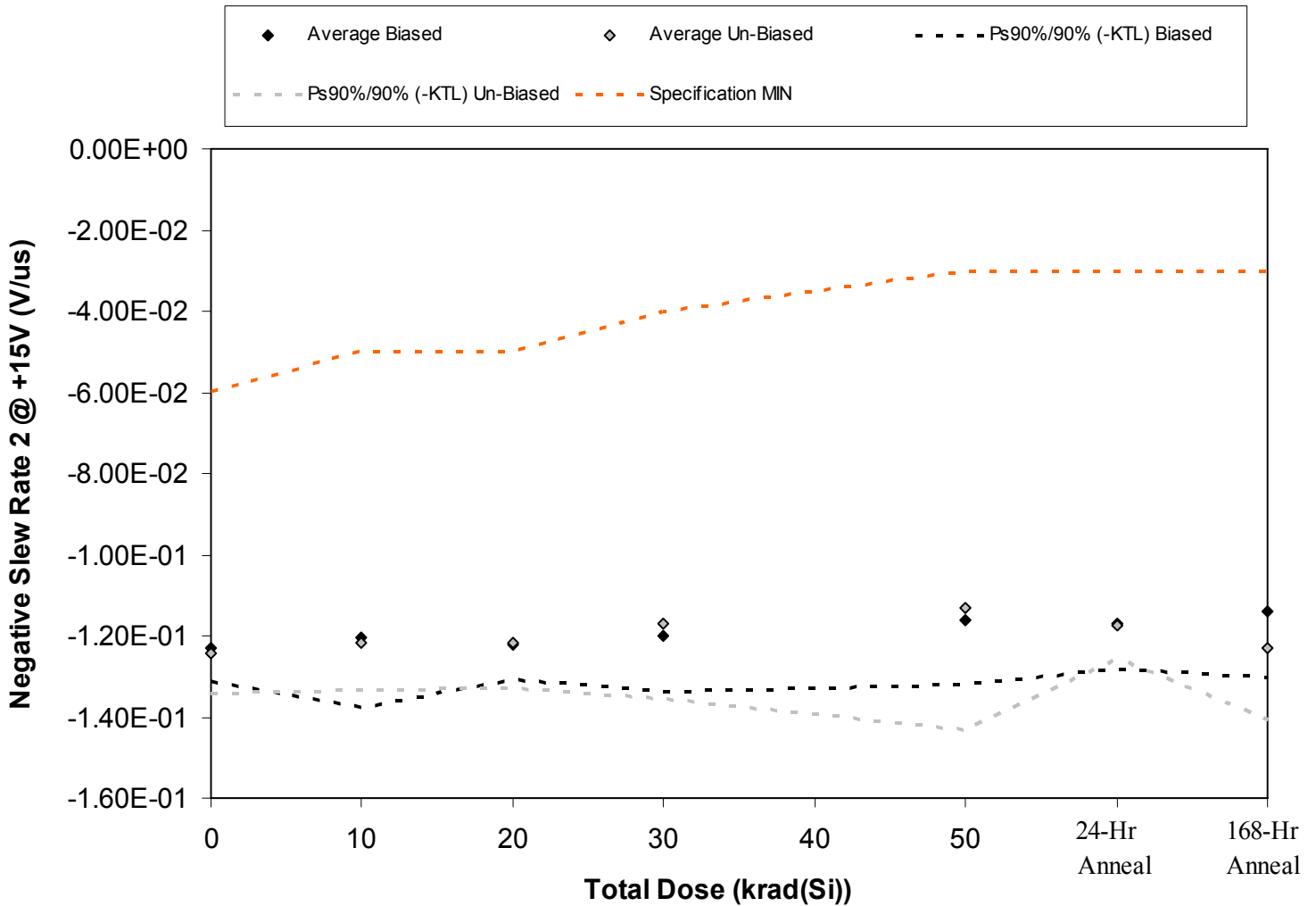

Figure 5.62. Plot of Negative Slew Rate 2 @ +15V (V/us) versus total dose. The solid diamonds are the average of the measured data points for the samples irradiated under electrical bias while the shaded diamonds are the average of the measured data points for the samples irradiated with all pins tied to ground. The black lines (solid and/or dashed) are the average of the data points after application of the KTL statistics on the samples irradiated under electrical bias while the gray lines (solid and/or dashed) are the average of the data points after application of the KTL statistics on the samples irradiated in the unbiased condition. The red dotted line(s) are the pre- and/or post-irradiation minimum and/or maximum specification value as defined in the datasheet and/or test plan.



Table 5.62. Raw data for Negative Slew Rate 2 @ +15V (V/us) versus total dose, including the statistical analysis, specification and the status of the testing (pass/fail).

Negative Slew Rate 2 @ +15V (V/us)	Total Dose (krad(Si))					24 hr Anneal	168 hr Anneal
	0	10	20	30	50		
Device							
255	-1.24E-01	-1.21E-01	-1.22E-01	-1.16E-01	-1.10E-01	-1.15E-01	-1.13E-01
258	-1.23E-01	-1.11E-01	-1.18E-01	-1.27E-01	-1.16E-01	-1.17E-01	-1.19E-01
309	-1.21E-01	-1.25E-01	-1.26E-01	-1.18E-01	-1.22E-01	-1.22E-01	-1.05E-01
359	-1.27E-01	-1.27E-01	-1.24E-01	-1.23E-01	-1.22E-01	-1.20E-01	-1.20E-01
360	-1.19E-01	-1.19E-01	-1.20E-01	-1.15E-01	-1.11E-01	-1.12E-01	-1.12E-01
416	-1.19E-01	-1.18E-01	-1.15E-01	-1.13E-01	-9.50E-02	-1.13E-01	-1.18E-01
472	-1.25E-01	-1.27E-01	-1.23E-01	-1.20E-01	-1.17E-01	-1.18E-01	-1.29E-01
473	-1.23E-01	-1.17E-01	-1.23E-01	-1.17E-01	-1.11E-01	-1.20E-01	-1.15E-01
526	-1.28E-01	-1.25E-01	-1.22E-01	-1.26E-01	-1.19E-01	-1.20E-01	-1.29E-01
529	-1.27E-01	-1.21E-01	-1.26E-01	-1.08E-01	-1.23E-01	-1.17E-01	-1.25E-01
530	-1.23E-01	-1.29E-01	-1.29E-01	-1.27E-01	-1.21E-01	-1.33E-01	-1.25E-01
561	-1.21E-01	-1.06E-01	-1.22E-01	-1.24E-01	-1.26E-01	-1.22E-01	-1.23E-01
<b>Biased Statistics</b>							
Average Biased	-1.23E-01	-1.21E-01	-1.22E-01	-1.20E-01	-1.16E-01	-1.17E-01	-1.14E-01
Std Dev Biased	3.03E-03	6.23E-03	3.16E-03	5.07E-03	5.76E-03	3.96E-03	6.06E-03
Ps90%/90% (+KTL) Biased	-1.14E-01	-1.04E-01	-1.13E-01	-1.06E-01	-1.00E-01	-1.06E-01	-9.72E-02
Ps90%/90% (-KTL) Biased	-1.31E-01	-1.38E-01	-1.31E-01	-1.34E-01	-1.32E-01	-1.28E-01	-1.30E-01
<b>Un-Biased Statistics</b>							
Average Un-Biased	-1.24E-01	-1.22E-01	-1.22E-01	-1.17E-01	-1.13E-01	-1.18E-01	-1.23E-01
Std Dev Un-Biased	3.58E-03	4.34E-03	4.09E-03	6.83E-03	1.10E-02	2.88E-03	6.42E-03
Ps90%/90% (+KTL) Un-Biased	-1.15E-01	-1.10E-01	-1.11E-01	-9.81E-02	-8.30E-02	-1.10E-01	-1.06E-01
Ps90%/90% (-KTL) Un-Biased	-1.34E-01	-1.33E-01	-1.33E-01	-1.36E-01	-1.43E-01	-1.25E-01	-1.41E-01
<b>Specification MIN</b>	<b>-6.00E-02</b>	<b>-5.00E-02</b>	<b>-5.00E-02</b>	<b>-4.00E-02</b>	<b>-3.00E-02</b>	<b>-3.00E-02</b>	<b>-3.00E-02</b>
Status	PASS	PASS	PASS	PASS	PASS	PASS	PASS



## **6.0. Summary / Conclusions**

The high dose rate total ionizing dose testing described in this final report was performed using the facilities at Radiation Assured Devices' Longmire Laboratories in Colorado Springs, CO. The high dose rate total ionizing dose (TID) source is a JLSA 84-21 irradiator modified to provide a panoramic exposure. The dose rate for this irradiator in this configuration ranges from  $<1\text{rad}(\text{Si})/\text{s}$  to a maximum of approximately  $120\text{rad}(\text{Si})/\text{s}$ , determined by the distance from the source.

Samples of the RH1078MJ8 Dual Precision Op Amp described in this report were irradiated biased with a static split 15V supply and unbiased (all leads tied to ground). The devices were irradiated to a maximum total ionizing dose level of  $50\text{krad}(\text{Si})$  with a pre-irradiation baseline reading as well as incremental readings at 10, 20, and  $30\text{krad}(\text{Si})$ . Electrical testing occurred within one hour following the end of each irradiation segment. For intermediate irradiations, the units were tested and returned to total dose exposure within two hours from the end of the previous radiation increment. In addition, all units-under-test received a 24hr room temperature and 168hr  $100^\circ\text{C}$  anneal, using the same bias conditions as the radiation exposure.

The parametric data was obtained as "read and record" and all the raw data plus an attributes summary are contained in this report as well as in a separate Excel file. The attributes data contains the average, standard deviation and the average with the KTL values applied. The KTL values used is 2.742 per MIL HDBK 814 using one sided tolerance limits of 90/90 and a 5-piece sample size. This survival probability/level of confidence is consistent with a 22-piece sample size and zero failures analyzed using a lot tolerance percent defective (LTPD) approach. Note that the following criteria must be met for a device to pass the total dose test: following the radiation exposure each of the 5 pieces irradiated under electrical bias shall pass the specification value. The units irradiated without electrical bias and the KTL statistics are included in this report for reference only. If any of the 5 pieces irradiated under electrical bias exceed the datasheet specifications, then the lot could be logged as a failure.

Using the conditions stated above, the RH1078MJ8 Dual Precision Op Amp (from the lot date code identified on the first page of this test report) passed the total dose test to the maximum tested level of  $50\text{krad}(\text{Si})$  with no significant degradation observed on any measured parameter. Note that the data presented in this report for the units-under-test irradiated in the unbiased condition and the KTL statistics are for reference only and are not used for the determination of "PASS/FAIL" for the lot. Further, the data in this report can be analyzed along with the report titled "Enhanced Low Dose Rate Sensitivity (ELDRS) Radiation Testing of the RH1078MJ8 Dual Precision Op Amp for Linear Technology" to demonstrate that these parts do not exhibit ELDRS as defined in the current test method.



Appendix A: Photograph of device-under-test to show part markings





## Appendix B: TID Bias Connections

### Biased Samples:

Pin	Function	Connection / Bias
1	OUT A	To Pin 2 via 10k $\Omega$ Resistor
2	-INPUT A	To Pin 1 via 10k $\Omega$ Resistor
3	+INPUT A	To 8V via 10k $\Omega$ Resistor
4	V-	To -15V using 0.1 $\mu$ F Decoupling
5	+INPUT B	To 8V via 10k $\Omega$ Resistor
6	-INPUT B	To Pin 9 via 10k $\Omega$ Resistor
7	OUT B	To Pin 8 via 10k $\Omega$ Resistor
8	V+	To +15V using 0.1 $\mu$ F Decoupling

### Unbiased Samples:

Pin	Function	Connection / Bias
1	OUT A	GND
2	-INPUT A	GND
3	+INPUT A	GND
4	V-	GND
5	+INPUT B	GND
6	-INPUT B	GND
7	OUT B	GND
8	V+	GND

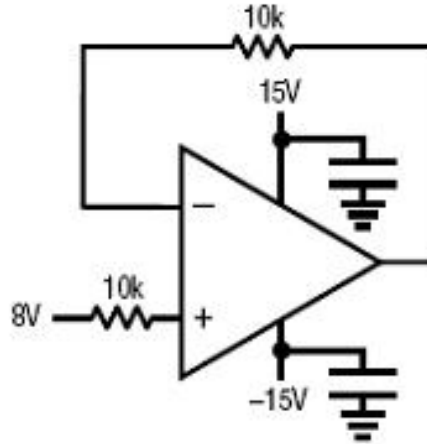

Figure B.1. Irradiation bias drawing for the units to be irradiated under electrical bias. This figure was extracted from LINEAR TECHNOLOGY CORPORATION RH1078M Datasheet.

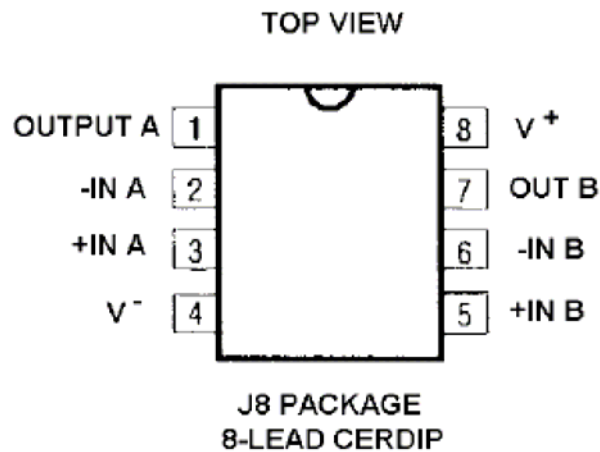

Figure B.2. J8 package drawing (for reference only). This figure was extracted from LINEAR TECHNOLOGY CORPORATION, Drawing Number: 05-08-5020 REV. K "MICROCIRCUIT, LINEAR, MFG RH1078M, MICROPOWER, DUAL, SINGLE SUPPLY, PRECISION OP AMP".



## Appendix C: Electrical Test Parameters and Conditions

All electrical tests for this device are performed on one of Radiation Assured Device's LTS2020 Test Systems. The LTS2020 Test System is a programmable parametric tester that provides parameter measurements for a variety of digital, analog and mixed signal products including voltage regulators, operational amplifiers, voltage comparators, D to A and A to D converters. The LTS2020 Test System achieves accuracy and sensitivity through the use of software self-calibration and an internal relay matrix with separate family boards and custom personality adapter boards. The tester uses this relay matrix to connect the required test circuits, select the appropriate voltage / current sources and establish the needed measurement loops for all the tests performed. The measured parameters and test conditions are shown in Table C.1.

Note that test numbers 19 and 20 are modified from the datasheet condition of  $V_{CM}=100mV$  to  $V_{CM}=0V$ . This is because the LTS2020 measurement circuit has an impedance of  $\sim 333k\Omega$ , such that at 100mV it is effectively injecting  $\sim 300nA$  of current. This is enough to raise the measured  $V_{OL}$  by  $\sim 1mV$ . In our estimation, modifying the test condition as specified, plus biasing the amp not being measured to have a  $V_{OUT}$  of  $\sim 100mV$  to make sure it's not saturated, reduces the current injected by the measurement circuit to  $\sim 30nA$  or less.

A listing of the measurement precision/resolution for each parameter is shown in Table C.2. The precision/resolution values were obtained either from test data or from the DAC resolution of the LTS-2020. To generate the precision/resolution shown in Table C.2, one of the units-under-test was tested repetitively (a total of 10-times with re-insertion between tests) to obtain the average test value and standard deviation. Using this test data MIL-HDBK-814 90/90 KTL statistics were applied to the measured standard deviation to generate the final measurement range. This value encompasses the precision/resolution of all aspects of the test system, including the LTS2020 mainframe, family board, socket assembly and DUT board as well as insertion error. In some cases, the measurement resolution is limited by the internal DACs, which results in a measured standard deviation of zero. In these instances the precision/resolution will be reported back as the LSB of the DAC.

Note that the testing and statistics used in this document are based on an "analysis of variables" technique, which relies on small sample sizes to qualify much larger lot sizes (see MIL-HDBK-814, p. 91 for a discussion of statistical treatments). Unfortunately, not all measured parameters are well suited to this approach due to inherent large variations. One such parameter is pre-irradiation Open Loop Gain, where the device exhibits extreme sensitivity to input conditions, resulting in a very large standard deviation and a statistical error often greater than the measured value. If necessary, larger samples sizes could be used to qualify these parameters using an "attributes" approach.





Table C.1. Measured parameters and test conditions for the RH1078MJ8.

TEST NUMBER	TEST DESCRIPTION	TEST CONDITIONS
1	Positive Supply Current ( $I_{CC2}$ )	$V=+5V$
2	Negative Supply Current ( $I_{EE2}$ )	$V=+5V$
3 & 4	Input Offset Voltage ( $V_{OS1}$ & $V_{OS2}$ )	$V=+5V$
5 & 6	Input Offset Current ( $I_{OS1}$ & $I_{OS2}$ )	$V=+5V$
7 & 8	+ Input Bias Current ( $I_{B+1}$ & $I_{B+2}$ )	$V=+5V$
9 & 10	- Input Bias Current ( $I_{B-1}$ & $I_{B-2}$ )	$V=+5V$
11 & 12	Common Mode Rejection Ratio (CMRR1 & CMRR2)	$V=+5V$ , $V_{CM} = 0V$ to $3.5V$
13 & 14	Power Supply Rejection Ratio (PSRR1 & PSRR2)	$V= 2.3V$ to $12V$
15 & 16	Large Signal Voltage Gain ( $A_{VOL1}$ & $A_{VOL2}$ )	$V=+5V$ , $R_L = Open$
17 & 18	Large Signal Voltage Gain ( $A_{VOL3}$ & $A_{VOL4}$ )	$V=+5V$ , $R_L = 50k\Omega$
19 & 20	$V_{OUT}$ Low ( $V_{OUTLOW1}$ & $V_{OUTLOW2}$ )	$V=+5V$ , $R_L = Open$ , $V_{CM} = 0V^*$
21 & 22	$V_{OUT}$ Low ( $V_{OUTLOW3}$ & $V_{OUTLOW4}$ )	$V=+5V$ , $R_L = 2k\Omega$
23 & 24	$V_{OUT}$ Low ( $V_{OUTLOW5}$ & $V_{OUTLOW6}$ )	$V=+5V$ , $I_{SINK} = 100\mu A$
25 & 26	$V_{OUT}$ High ( $V_{OUTHIGH1}$ & $V_{OUTHIGH2}$ )	$V=+5V$ , $R_L = Open$
27 & 28	$V_{OUT}$ High ( $V_{OUTHIGH3}$ & $V_{OUTHIGH4}$ )	$V=+5V$ , $R_L = 2k\Omega$
29 & 30	+SR (Slew Rate 1 and Slew Rate 2)	$V=+5V$ , $A_V = 1$
31 & 32	-SR (Slew Rate 3 and Slew Rate 4)	$V=+5V$ , $A_V = 1$
33	Positive Supply Current ( $I_{CC2}$ )	$V=\pm 15V$
34	Negative Supply Current ( $I_{EE2}$ )	$V=\pm 15V$
35 & 36	Input Offset Voltage ( $V_{OS3}$ & $V_{OS4}$ )	$V=\pm 15V$
37 & 38	Input Offset Current ( $I_{OS3}$ & $I_{OS4}$ )	$V=\pm 15V$
39 & 40	+ Input Bias Current ( $I_{B+3}$ & $I_{B+4}$ )	$V=\pm 15V$
41 & 42	- Input Bias Current ( $I_{B-3}$ & $I_{B-4}$ )	$V=\pm 15V$



**TID Report  
10-004 100412 R1.0**

**Radiation Assured Devices  
5017 N. 30th Street  
Colorado Springs, CO 80919  
(719) 531-0800**

<b>TEST NUMBER</b>	<b>TEST DESCRIPTION</b>	<b>TEST CONDITIONS</b>
43 & 44	Common Mode Rejection Ratio (CMRR3 & CMRR4)	$V=\pm 15V, V_{CM} = 13.5V, -15V$
45 & 46	Power Supply Rejection Ratio (PSRR3 & PSRR4)	$V= 5V, 0V \text{ to } \pm 18V$
47 & 48	Large Signal Voltage Gain ( $A_{VOL5}$ & $A_{VOL6}$ )	$V=\pm 15V, R_L=50k\Omega$
49 & 50	Large Signal Voltage Gain ( $A_{VOL7}$ & $A_{VOL8}$ )	$V=\pm 15V, R_L=2k\Omega$
51 & 52	$V_{OUT}$ High ( $V_{OUTHIGH5}$ & $V_{OUTHIGH6}$ )	$V=\pm 15V, R_L=50k\Omega$
53 & 54	$V_{OUT}$ High ( $V_{OUTHIGH7}$ & $V_{OUTHIGH8}$ )	$V=\pm 15V, R_L=2k\Omega$
55 & 56	$V_{OUT}$ Low ( $V_{OUTLOW7}$ & $V_{OUTLOW8}$ )	$V=\pm 15V, R_L=50k\Omega$
57 & 58	$V_{OUT}$ Low ( $V_{OUTLOW9}$ & $V_{OUTLOW10}$ )	$V=\pm 15V, R_L=2k\Omega$
59 & 60	+SR (Slew Rate 5 and Slew Rate 6)	$V=\pm 15V, A_V=1$
60 & 61	-SR (Slew Rate 7 and Slew Rate 8)	$V=\pm 15V, A_V=1$

\* This is non-datasheet condition, see above for explanation.



Table C.2. Measured parameters, pre-irradiation specifications and measurement resolution for the RH1078MJ8.

<b>Measured Parameter</b>	<b>Pre-Irradiation Specification</b>	<b>Measurement Resolution/Precision</b>
Positive Supply Current ( $I_{CC}$ )	1.5E-04A	$\pm 1.31E-06A$
Negative Supply Current ( $I_{EE}$ )	-1.5E-04A	$\pm 1.07E-06A$
Input Offset Voltage ( $V_{OS1}$ & $V_{OS2}$ )	$\pm 1.2E-04V$	$\pm 3.41E-06V$
Input Offset Current ( $I_{OS1}$ & $I_{OS2}$ )	$\pm 8E-10A$	$\pm 5.06E-11A$
+ Input Bias Current ( $I_{B+1}$ & $I_{B+2}$ )	$\pm 1.5E-08A$	$\pm 5.88E-11A$
- Input Bias Current ( $I_{B-1}$ & $I_{B-2}$ )	$\pm 1.5E-08A$	$\pm 8.03E-11A$
Common Mode Rejection Ratio (CMRR1 & CMRR2)	94dB	$\pm 3.12E+00$ dB
Power Supply Rejection Ratio (PSRR1 & PSRR2)	100dB	$\pm 5.70E+00$ dB
Large Signal Voltage Gain ( $A_{VOL1}$ & $A_{VOL2}$ )	150V/mV	$\pm 2.69E+02V/mV$
Large Signal Voltage Gain ( $A_{VOL3}$ & $A_{VOL4}$ )	120V/mV	$\pm 7.13E+02$ V/mV
$V_{OUT}$ Low ( $V_{OUTLOW1}$ & $V_{OUTLOW2}$ )	6E-03V	$\pm 1.16E-04V$
$V_{OUT}$ Low ( $V_{OUTLOW3}$ & $V_{OUTLOW4}$ )	2E-03V	$\pm 3.43E-05V$
$V_{OUT}$ Low ( $V_{OUTLOW5}$ & $V_{OUTLOW6}$ )	1.3E-01V	$\pm 3.22E-04V$
$V_{OUT}$ High ( $V_{OUTHIGH1}$ & $V_{OUTHIGH2}$ )	4.2V	$\pm 3.11E-03V$
$V_{OUT}$ High ( $V_{OUTHIGH3}$ & $V_{OUTHIGH4}$ )	3.5V	$\pm 2.13E-03V$
+SR (Slew Rate 1 and Slew Rate 2)	4E-02V/ $\mu$ s	$\pm 1.07E-03V/\mu$ s
-SR (Slew Rate 3 and Slew Rate 4)	-4E-02V/ $\mu$ s	$\pm 1.81E-03$ V/ $\mu$ s
Positive Supply Current ( $I_{CC2}$ )	2E-04A	$\pm 1.74E-06A$



<b>Measured Parameter</b>	<b>Pre-Irradiation Specification</b>	<b>Measurement Resolution/Precision</b>
Negative Supply Current ( $I_{EE2}$ )	-2E-04A	$\pm 9.73E-07A$
Input Offset Voltage ( $V_{OS3}$ & $V_{OS4}$ )	$\pm 3.5E-4V$	$\pm 2.51E-06V$
Input Offset Current ( $I_{OS3}$ & $I_{OS4}$ )	$\pm 8E-10A$	$\pm 3.54E-11A$
+ Input Bias Current ( $I_{B+3}$ & $I_{B+4}$ )	$\pm 1.5E-08A$	$\pm 3.89E-11A$
- Input Bias Current ( $I_{B-3}$ & $I_{B-4}$ )	$\pm 1.5E-08A$	$\pm 7.51E-11A$
Common Mode Rejection Ratio (CMRR3 & CMRR4)	97dB	$\pm 2.98E-01dB$
Power Supply Rejection Ratio (PSRR3 & PSRR4)	100dB	$\pm 4.20E+00dB$
Large Signal Voltage Gain ( $A_{VOL5}$ & $A_{VOL6}$ )	1000V/mV	$\pm 2.34E+04V/mV$
Large Signal Voltage Gain ( $A_{VOL7}$ & $A_{VOL8}$ )	300V/mV	$\pm 7.07E+01V/mV$
$V_{OUT}$ High ( $V_{OUTHIGH5}$ & $V_{OUTHIGH6}$ )	13V	$\pm 2.38E-03V$
$V_{OUT}$ High ( $V_{OUTHIGH7}$ & $V_{OUTHIGH8}$ )	11V	$\pm 1.17E-03V$
$V_{OUT}$ Low ( $V_{OUTLOW7}$ & $V_{OUTLOW8}$ )	-13V	$\pm 1.75E-03V$
$V_{OUT}$ Low ( $V_{OUTLOW9}$ & $V_{OUTLOW10}$ )	-11V	$\pm 4.14E-03V$
+SR (Slew Rate 5 and Slew Rate 6)	6E-02V/ $\mu s$	$\pm 6.97E-03V/\mu s$
-SR (Slew Rate 7 and Slew Rate 8)	-6E-02V/ $\mu s$	$\pm 9.02E-03V/\mu s$



## Appendix D: List of Figures used in Section 5 (Test Results)

- 5.1 Positive Supply Current @ +5V (A)
- 5.2 Negative Supply Current @ +5V (A)
- 5.3 Input Offset Voltage 1 @ +5V (V)
- 5.4 Input Offset Voltage 2 @ +5V (V)
- 5.5 Input Offset Current 1 @ +5V (A)
- 5.6 Input Offset Current 2 @ +5V (A)
- 5.7 Positive Input Bias Current 1 @ +5V (A)
- 5.8 Positive Input Bias Current 2 @ +5V (A)
- 5.9 Negative Input Bias Current 1 @ +5V (A)
- 5.10 Negative Input Bias Current 2 @ +5V (A)
- 5.11 Common Mode Rejection Ratio 1 @ +5V (dB)
- 5.12 Common Mode Rejection Ratio 2 @ +5V (dB)
- 5.13 Power Supply Rejection Ratio 1 @ +5V (dB)
- 5.14 Power Supply Rejection Ratio 2 @ +5V (dB)
- 5.15 Open Loop Gain 1 @ +5V, RL=open (V/mV)
- 5.16 Open Loop Gain 2 @ +5V, RL=open (V/mV)
- 5.17 Open Loop Gain 1 @ +5V, RL=50kΩ (V/mV)
- 5.18 Open Loop Gain 2 @ +5V, RL=50kΩ (V/mV)
- 5.19 Output Voltage Low 1 @ +5V RL=open (V)
- 5.20 Output Voltage Low 2 @ +5V RL=open (V)
- 5.21 Output Voltage Low 1 @ +5V RL=2kΩ (V)
- 5.22 Output Voltage Low 2 @ +5V RL=2kΩ (V)
- 5.23 Output Voltage Low 1 @ +5V IL=100uA (V)
- 5.24 Output Voltage Low 2 @ +5V IL=100uA (V)
- 5.25 Output Voltage High 1 @ +5V RL=open (V)
- 5.26 Output Voltage High 2 @ +5V RL=open (V)
- 5.27 Output Voltage High 1 @ +5V RL=2kΩ (V)
- 5.28 Output Voltage High 2 @ +5V RL=2kΩ (V)
- 5.29 Positive Slew Rate 1 @ +5V (V/us)
- 5.30 Positive Slew Rate 2 @ +5V (V/us)
- 5.31 Negative Slew Rate 1 @ +5V (V/us)
- 5.32 Negative Slew Rate 2 @ +5V (V/us)
- 5.33 Positive Supply Current @ +15V (A)
- 5.34 Negative Supply Current @ +15V (A)
- 5.35 Input Offset Voltage 1 @ +15V (V)
- 5.36 Input Offset Voltage 2 @ +15V (V)
- 5.37 Input Offset Current 1 @ +15V (A)
- 5.38 Input Offset Current 2 @ +15V (A)
- 5.39 Positive Input Bias Current 1 @ +15V (A)



**TID Report  
10-004 100412 R1.0**

**Radiation Assured Devices  
5017 N. 30th Street  
Colorado Springs, CO 80919  
(719) 531-0800**

- 5.40 Positive Input Bias Current 2 @ +15V (A)
- 5.41 Negative Input Bias Current 1 @ +15V (A)
- 5.42 Negative Input Bias Current 2 @ +15V (A)
- 5.43 Common Mode Rejection Ratio 1 @ +15V (dB)
- 5.44 Common Mode Rejection Ratio 2 @ +15V (dB)
- 5.45 Power Supply Rejection Ratio 1 @ +15V (dB)
- 5.46 Power Supply Rejection Ratio 2 @ +15V (dB)
- 5.47 Open Loop Gain 1 @ +15V, RL=50kΩ (V/mV)
- 5.48 Open Loop Gain 2 @ +15V, RL=50kΩ (V/mV)
- 5.49 Open Loop Gain 1 @ +15V, RL=2kΩ (V/mV)
- 5.50 Open Loop Gain 2 @ +15V, RL=2kΩ (V/mV)
- 5.51 Output Voltage High 1 @ +15V RL=open (V)
- 5.52 Output Voltage High 2 @ +15V RL=open (V)
- 5.53 Output Voltage High 1 @ +15V RL=2kΩ (V)
- 5.54 Output Voltage High 2 @ +15V RL=2kΩ (V)
- 5.55 Output Voltage Low 1 @ +15V RL=open (V)
- 5.56 Output Voltage Low 2 @ +15V RL=open (V)
- 5.57 Output Voltage Low 1 @ +15V RL=2kΩ (V)
- 5.58 Output Voltage Low 2 @ +15V RL=2kΩ (V)
- 5.59 Positive Slew Rate 1 @ +15V (V/us)
- 5.60 Positive Slew Rate 2 @ +15V (V/us)
- 5.61 Negative Slew Rate 1 @ +15V (V/us)
- 5.62 Negative Slew Rate 2 @ +15V (V/us)