



Radiation Lot Acceptance Testing (RLAT) Radiation Testing of the RH1021CMH-5 Precision 5V Reference for Linear Technology

Customer: Linear Technology (PO# 52631L)

RAD Job Number: 09-167

Part Type Tested: Linear Technology RH1021CMH-5 Precision 5V Reference

Commercial Part Number: RH1021CMH-5

Traceability Information: Lot Date Code: 0913A, Assembly Lot# 501439.1, FAB Lot# 10222458.1, Wafer 9 (Obtained from Linear Technology PO 52631L). See photograph of unit under test in Appendix A.

Quantity of Units: 12 units total, 5 units for biased irradiation, 5 units for unbiased irradiation and 2 control units. Serial numbers 14-18 were biased during irradiation, serial numbers 20, 34-37 were unbiased during irradiation and serial numbers 38 and 40 were used as controls. See Appendix B for the radiation bias connection table.

External Traveler: None Required

Pre-Irradiation Burn-In: Burn-In performed by Linear Technology prior to receipt by RAD.

TID Dose Rate and Test Increments: 50-300rad(Si)/s with readings pre-irradiation and at the following dose increments: 20krad(Si), 50krad(Si), 100krad(Si), and 200krad(Si).

TID Overtest and Post-Irradiation Anneal: No overtest or anneal.

TID Test Standard: MIL-STD-883G, Method 1019.7, Condition A

TID Electrical Test Conditions: Pre-irradiation, and within one hour following each radiation exposure.

Test Hardware: LTS2020 Tester, Entity ID: TS04, Calibration Date 04/28/09 Calibration Due 04/28/10 2101 Family Board, 0600 Fixture and BGSS-030309 DUT Board

Facility and Radiation Source: Radiation Assured Devices Longmire Laboratories, Colorado Springs, CO using the JLSA 81-24 high dose rate Co60 source. Dosimetry performed by CaF TLDs traceable to NIST. RAD's dosimetry has been audited by DSCC and RAD has been awarded Laboratory Suitability for MIL-STD-750 TM 1019.5

Irradiation and Test Temperature: Room temperature for irradiation and test controlled to $24^{\circ}\text{C} \pm 6^{\circ}\text{C}$ per MIL-STD-883.

RLAT Result: PASSED. The units-under-test passed to the maximum tested dose level of 200krad(Si). Note that the output voltage and line regulation parameters showed degradation during the test.



1.0. Overview and Background

It is well known that total dose ionizing radiation can cause parametric degradation and ultimately functional failure in electronic devices. The damage occurs via electron-hole pair production, transport and trapping in the dielectric and interface regions. In discrete devices the bulk of the damage is frequently manifested as a reduction in the gain and/or breakdown voltage of the device. The damage will usually anneal with time following the end of the radiation exposure. Due to this annealing, and to ensure a worst-case test condition MIL-STD-883 TM1019.7 calls out a dose rate of 50 to 300rad(Si)/s as Condition A and further specifies that the time from the end of an incremental radiation exposure and electrical testing shall be 1-hour or less and the total time from the end of one incremental irradiation to the beginning of the next incremental radiation step should be 2-hours or less. The work described in this report was performed to meet MIL-STD-883 TM1019.7 Condition A.

2.0. Radiation Test Apparatus

The total ionizing dose testing described in this final report was performed using the facilities at Radiation Assured Devices' Longmire Laboratories in Colorado Springs, CO. The high dose rate total ionizing dose (TID) source is a JLSA 84-21 irradiator modified to provide a panoramic exposure. The Co-60 rods are held in the base of the irradiator heavily shielded by lead, during the radiation exposures the rod is raised by an electronic timer/controller and the exposure is performed in air. The dose rate for this irradiator in this configuration ranges from <1rad(Si)/s to a maximum of approximately 120rad(Si)/s, determined by the distance from the source. For high-dose rate experiments the bias boards are placed in a radial fashion equidistant from the raised Co-60 rods with the distance adjusted to provide the required dose rate. The irradiator calibration is maintained by Radiation Assured Devices Longmire Laboratories using thermoluminescent dosimeters (TLDs) traceable to the National Institute of Standards and Technology (NIST). Figure 2.1 shows a photograph of the JLSA 81-24 Co-60 irradiator at RAD's Longmire Laboratory facility.

RAD is currently certified by the Defense Supply Center Columbus (DSCC) for Laboratory Suitability under MIL STD 750. Additional details regarding Radiation Assured Devices dosimetry for TM1019 Condition A testing are available in RAD's report to DSCC entitled: "Dose Rate Mapping of the J.L. Shepherd and Associates Model 81 Irradiator Installed by Radiation Assured Devices"



Figure 2.1. Radiation Assured Devices' high dose rate Co-60 irradiator. The dose rate is obtained by positioning the device-under-test at a fixed distance from the gamma cell. The dose rate for this irradiator varies from approximately 120rad(Si)/s close to the rods down to 1rad(Si)/s at a distance of approximately 2-feet.



3.0. Radiation Test Conditions

The RH1021CMH precision 5V reference described in this final report was irradiated using a split 15V supply and with all pins tied to ground, that is biased and unbiased. See the TID Bias Table in Appendix B for the full bias circuits. In our opinion, these bias circuits satisfy the requirements of MIL-STD-883G TM1019.7 Section 3.9.3 Bias and Loading Conditions which states “The bias applied to the test devices shall be selected to produce the greatest radiation induced damage or the worst-case damage for the intended application, if known. While maximum voltage is often worst case some bipolar linear device parameters (e.g. input bias current or maximum output load current) exhibit more degradation with 0 V bias.”

The devices were irradiated to a maximum total ionizing dose level of 200krad(Si) with incremental readings at 20krad(Si), 50krad(Si) and 100krad(Si). Electrical testing occurred within one hour following the end of each irradiation segment. For the intermediate irradiations, the parts were tested and returned to total dose exposure within two hours from the end of the previous radiation increment.

The TID bias board was positioned in the Co-60 cell to provide the required minimum of 50rad(Si)/s and was located inside a lead-aluminum enclosure. The lead-aluminum enclosure is required under MIL-STD-883G TM1019.7 Section 3.4 that reads as follows: “Lead/Aluminum (Pb/Al) container. Test specimens shall be enclosed in a Pb/Al container to minimize dose enhancement effects caused by low-energy, scattered radiation. A minimum of 1.5 mm Pb, surrounding an inner shield of at least 0.7 mm Al, is required. This Pb/Al container produces an approximate charged particle equilibrium for Si and for TLDs such as CaF₂. The radiation field intensity shall be measured inside the Pb/Al container (1) initially, (2) when the source is changed, or (3) when the orientation or configuration of the source, container, or test-fixture is changed. This measurement shall be performed by placing a dosimeter (e.g., a TLD) in the device-irradiation container at the approximate test-device position. If it can be demonstrated that low energy scattered radiation is small enough that it will not cause dosimetry errors due to dose enhancement, the Pb/Al container may be omitted”.

The final dose rate within the high dose rate lead-aluminum enclosure was determined based on TLD dosimetry measurements (see previous section). The final dose rate for this work was 88.6rad(Si)/s with a precision of ±5%.



4.0. Tested Parameters

During the radiation lot acceptance testing the following pre- and post-irradiation electrical parameters were measured:

1. Supply Current
2. Output Voltage
3. Line Regulation $7.2V \leq V_{IN} \leq 10V$
4. Line Regulation $10V < V_{IN} \leq 40V$
5. Sourcing Load Regulation
6. Sinking Load Regulation

The parametric data was obtained as read and record and all the raw data plus an attributes summary are contained in a separate Excel file. The attributes data contains the average, standard deviation and the average with the KTL values applied. The KTL value used in this work is 2.742 per MIL-HDBK-814 using one sided tolerance limits of 90/90 and a 5-piece sample size. The 90/90 KTL values were selected to match the statistical levels specified in the MIL-PRF-38535 sampling plan for the qualification of a radiation hardness assured (RHA) component. Note that the following criteria must be met for a device to pass the RLAT: following the radiation exposure each of the 5 pieces shall pass the specification value and the average value for the ten-piece sample must pass the specification value when the KTL limits are applied. If either of these conditions is not satisfied following the radiation exposure, then the lot could be logged as a failure.

5.0. Total Ionizing Dose Test Results

The RH1021CMH precision 5V reference PASSED the RLAT to the maximum tested dose level of 200krad(Si) with only the output voltage and line regulation parameters showing significant degradation. Both of the measured line regulation parameters and the output voltage parameter stayed within specification, even after application of the KTL statistics. Note that the output voltage was out of specification after application of the 90/90 KTL statistics pre-irradiation, which in our opinion, is due to the standard deviation of the sample population (see Table C.2 for the measurement precision of the output voltage test).

The testing and statistics used in this document are based on an “analysis of variables” technique, which relies on small sample sizes to qualify much larger lot sizes (see MIL-HDBK-814, p. 91 for a discussion of statistical treatments). Not all measured parameters are well suited to this approach due to the standard deviation of the sample population or inherent large variations in the parameter. As noted above, larger samples sizes could be used to qualify these devices using an “attributes” approach.

As seen in the data plots below none of the other measured parameters showed any significant



degradation with radiation (other than the output voltage, as noted above). Figures 5.1 – 5.6 show plots of all the measured parameters versus total ionizing dose while Tables 5.1 – 5.6 show the corresponding raw data for each of these parameters.

In the data plots the solid diamonds are the average of the measured data points for the sample irradiated under electrical bias while the shaded diamonds are the average of the measured data points for the units irradiated with all pins tied to ground. The black lines (solid or dashed) are the average of the data points after application of the KTL statistics on the sample irradiated in the biased condition while the shaded lines (solid or dashed) are the average of the data points after application of the KTL statistics on the sample irradiated in the unbiased condition. The red dotted line(s) are the pre- and/or post-irradiation minimum and/or maximum specification value as defined in the datasheet and/or test plan.

The control units, as expected, show no significant changes to any of the parameters. Therefore we can conclude that the electrical testing remained in control throughout the duration of the tests and the observed degradation was due to the radiation exposure.

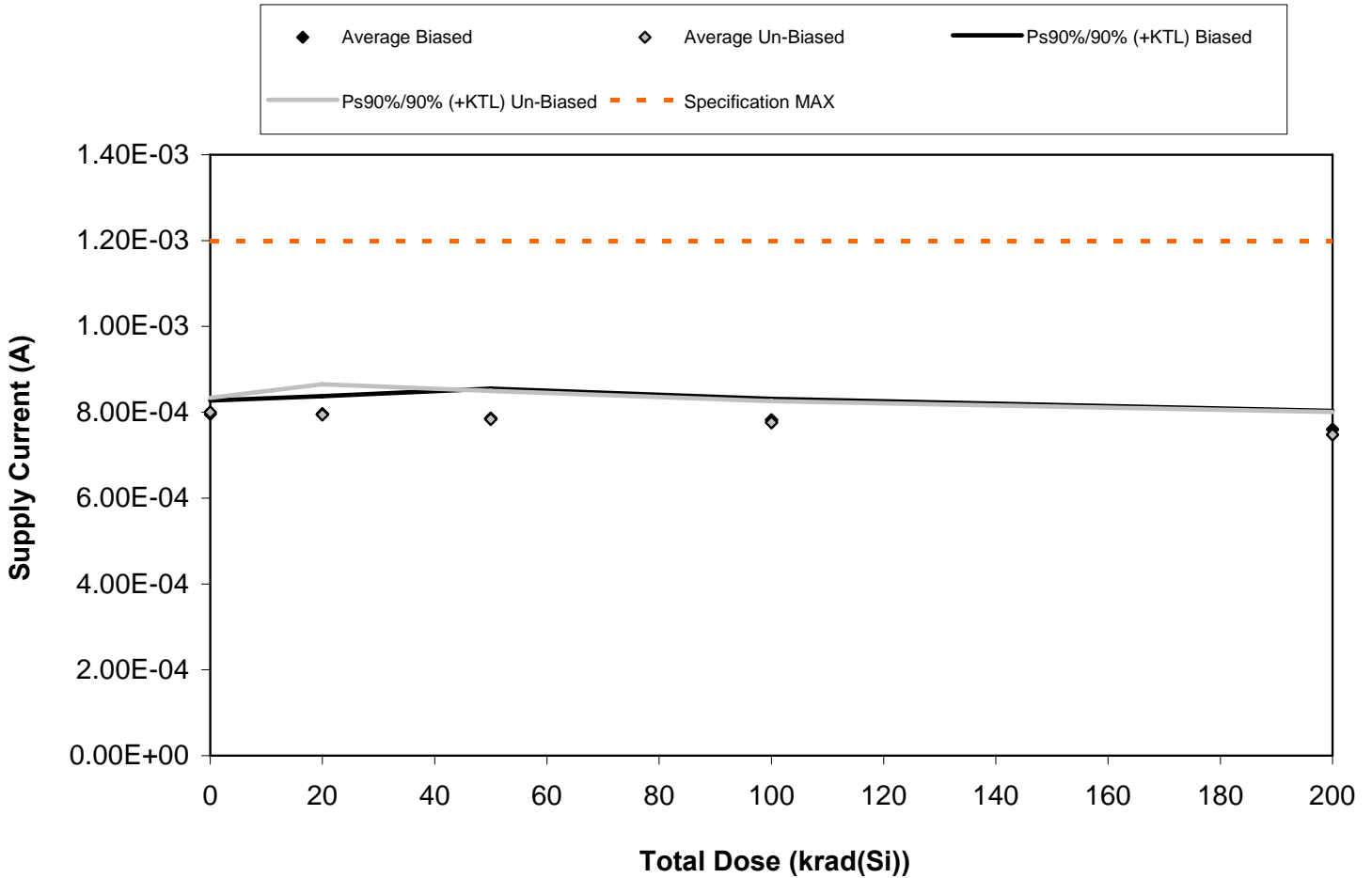

Figure 5.1. Plot of Supply Current (A) versus total dose. The data show no significant change with total dose. The solid diamonds are the average of the measured data points for the sample irradiated under electrical bias while the shaded diamonds are the average of the measured data points for the units irradiated with all pins tied to ground. The black lines (solid and/or dashed) are the average of the data points after application of the KTL statistics on the sample irradiated under electrical bias while the gray lines (solid and/or dashed) are the average of the data points after application of the KTL statistics on the samples irradiated in the unbiased condition. The red dotted line(s) are the pre- and/or post-irradiation minimum and/or maximum specification value as defined in the datasheet and/or test plan.



Table 5.1. Raw data for Supply Current (A) versus total dose, including the statistical analysis, specification and the status of the testing (pass/fail).

Supply Current (A)	Total Dose (krad(Si))				
	0	20	50	100	200
Device					
14	8.00E-04	8.00E-04	8.00E-04	7.80E-04	7.40E-04
15	7.90E-04	8.00E-04	8.00E-04	8.00E-04	7.50E-04
16	7.80E-04	8.10E-04	7.70E-04	8.00E-04	7.60E-04
17	8.10E-04	8.00E-04	8.10E-04	7.70E-04	7.80E-04
18	8.00E-04	7.70E-04	7.50E-04	7.60E-04	7.70E-04
20	8.20E-04	8.20E-04	8.10E-04	8.00E-04	7.60E-04
34	7.90E-04	7.60E-04	7.70E-04	7.60E-04	7.20E-04
35	8.00E-04	7.80E-04	7.70E-04	7.70E-04	7.70E-04
36	8.00E-04	7.90E-04	7.60E-04	7.60E-04	7.40E-04
37	7.90E-04	8.20E-04	8.10E-04	7.90E-04	7.50E-04
38	8.10E-04	8.20E-04	8.20E-04	8.00E-04	8.10E-04
40	8.00E-04	7.80E-04	8.10E-04	8.00E-04	8.20E-04
Biased Statistics					
Average Biased	7.96E-04	7.96E-04	7.86E-04	7.82E-04	7.60E-04
Std Dev Biased	1.14E-05	1.52E-05	2.51E-05	1.79E-05	1.58E-05
Ps90%/90% (+KTL) Biased	8.27E-04	8.38E-04	8.55E-04	8.31E-04	8.03E-04
Ps90%/90% (-KTL) Biased	7.65E-04	7.54E-04	7.17E-04	7.33E-04	7.17E-04
Un-Biased Statistics					
Average Un-Biased	8.00E-04	7.94E-04	7.84E-04	7.76E-04	7.48E-04
Std Dev Un-Biased	1.22E-05	2.61E-05	2.41E-05	1.82E-05	1.92E-05
Ps90%/90% (+KTL) Un-Biased	8.34E-04	8.66E-04	8.50E-04	8.26E-04	8.01E-04
Ps90%/90% (-KTL) Un-Biased	7.66E-04	7.22E-04	7.18E-04	7.26E-04	6.95E-04
Specification MAX	1.20E-03	1.20E-03	1.20E-03	1.20E-03	1.20E-03
Status	PASS	PASS	PASS	PASS	PASS

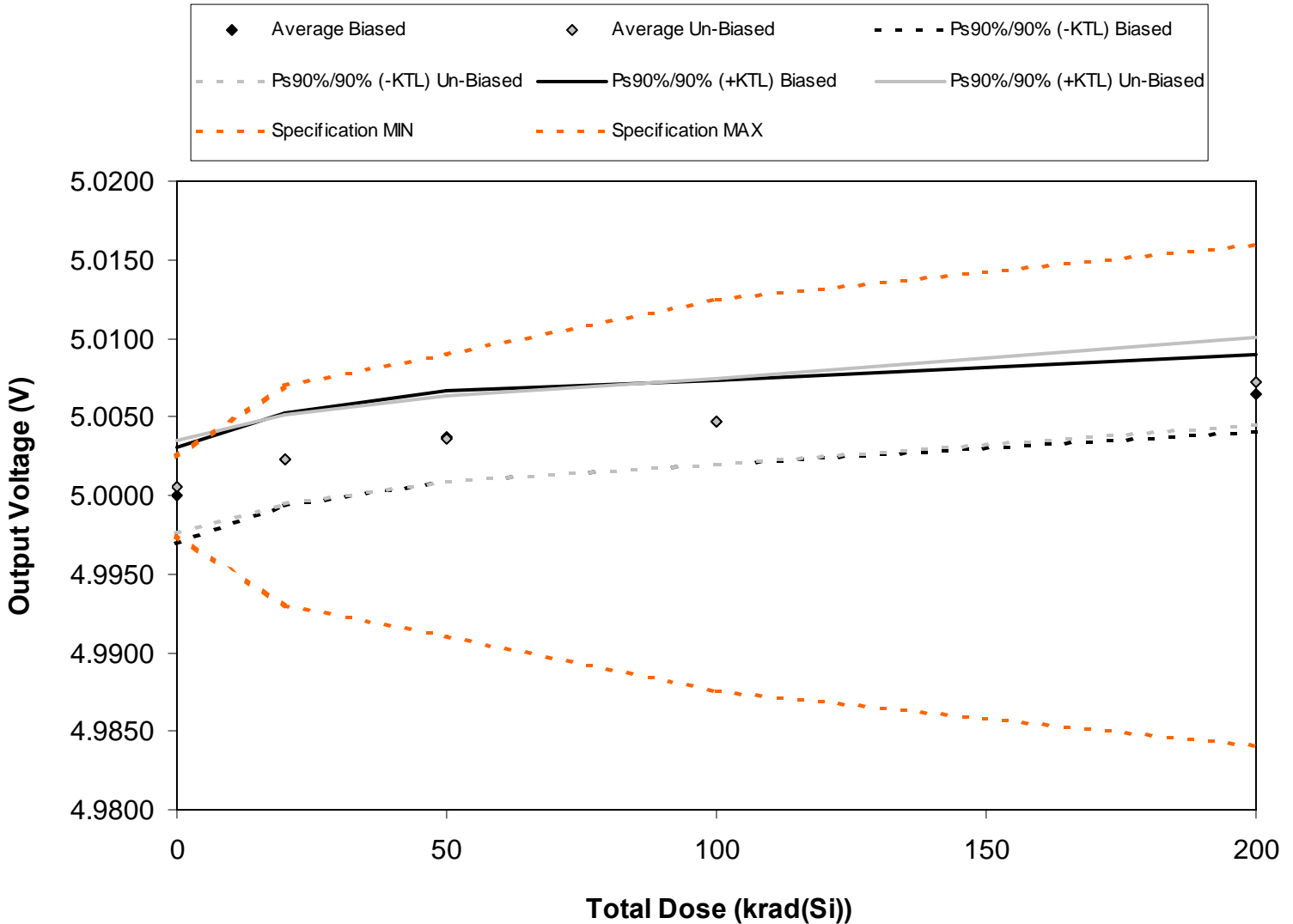

Figure 5.2. Plot of Output Voltage (V) versus total dose. This parameter shows a significant increase in output voltage with increasing radiation, although the parameter remains within specification including after application of the 90/90 KTL statistics. Note that the units are out of specification pre-irradiation, which we believe is due to the standard deviation of the sample population. The solid diamonds are the average of the measured data points for the sample irradiated under electrical bias while the shaded diamonds are the average of the measured data points for the units irradiated with all pins tied to ground. The black lines (solid and/or dashed) are the average of the data points after application of the KTL statistics on the sample irradiated under electrical bias while the gray lines (solid and/or dashed) are the average of the data points after application of the KTL statistics on the samples irradiated in the unbiased condition. The red dotted line(s) are the pre-and/or post-irradiation minimum and/or maximum specification value as defined in the datasheet and/or test plan.



Table 5.2. Raw data for Output Voltage (V) versus total dose, including the statistical analysis, specification and the status of the testing (pass/fail).

Output Voltage (V)	Total Dose (krad(Si))				
	0	20	50	100	200
Device					
14	4.9997	5.0019	5.0034	5.0047	5.0068
15	4.9993	5.0016	5.0030	5.0039	5.0054
16	5.0020	5.0042	5.0056	5.0063	5.0077
17	4.9995	5.0018	5.0033	5.0040	5.0058
18	4.9996	5.0019	5.0035	5.0044	5.0066
20	5.0000	5.0016	5.0031	5.0041	5.0067
34	4.9998	5.0015	5.0029	5.0039	5.0065
35	5.0017	5.0033	5.0046	5.0058	5.0085
36	4.9996	5.0015	5.0027	5.0038	5.0064
37	5.0018	5.0035	5.0048	5.0057	5.0082
38	4.9994	4.9996	5.0000	4.9995	4.9998
40	5.0009	5.0012	5.0015	5.0010	5.0013
Biased Statistics					
Average Biased	5.0000	5.0023	5.0038	5.0047	5.0065
Std Dev Biased	0.0011	0.0011	0.0010	0.0010	0.0009
Ps90%/90% (+KTL) Biased	5.0031	5.0052	5.0066	5.0073	5.0089
Ps90%/90% (-KTL) Biased	4.9970	4.9993	5.0009	5.0020	5.0040
Un-Biased Statistics					
Average Un-Biased	5.0006	5.0023	5.0036	5.0047	5.0073
Std Dev Un-Biased	0.0011	0.0010	0.0010	0.0010	0.0010
Ps90%/90% (+KTL) Un-Biased	5.0035	5.0051	5.0064	5.0074	5.0100
Ps90%/90% (-KTL) Un-Biased	4.9976	4.9995	5.0009	5.0019	5.0045
Specification MIN	4.9975	4.9930	4.9910	4.9875	4.9840
Status	FAIL	PASS	PASS	PASS	PASS
Specification MAX	5.0025	5.0070	5.0090	5.0125	5.0160
Status	FAIL	PASS	PASS	PASS	PASS

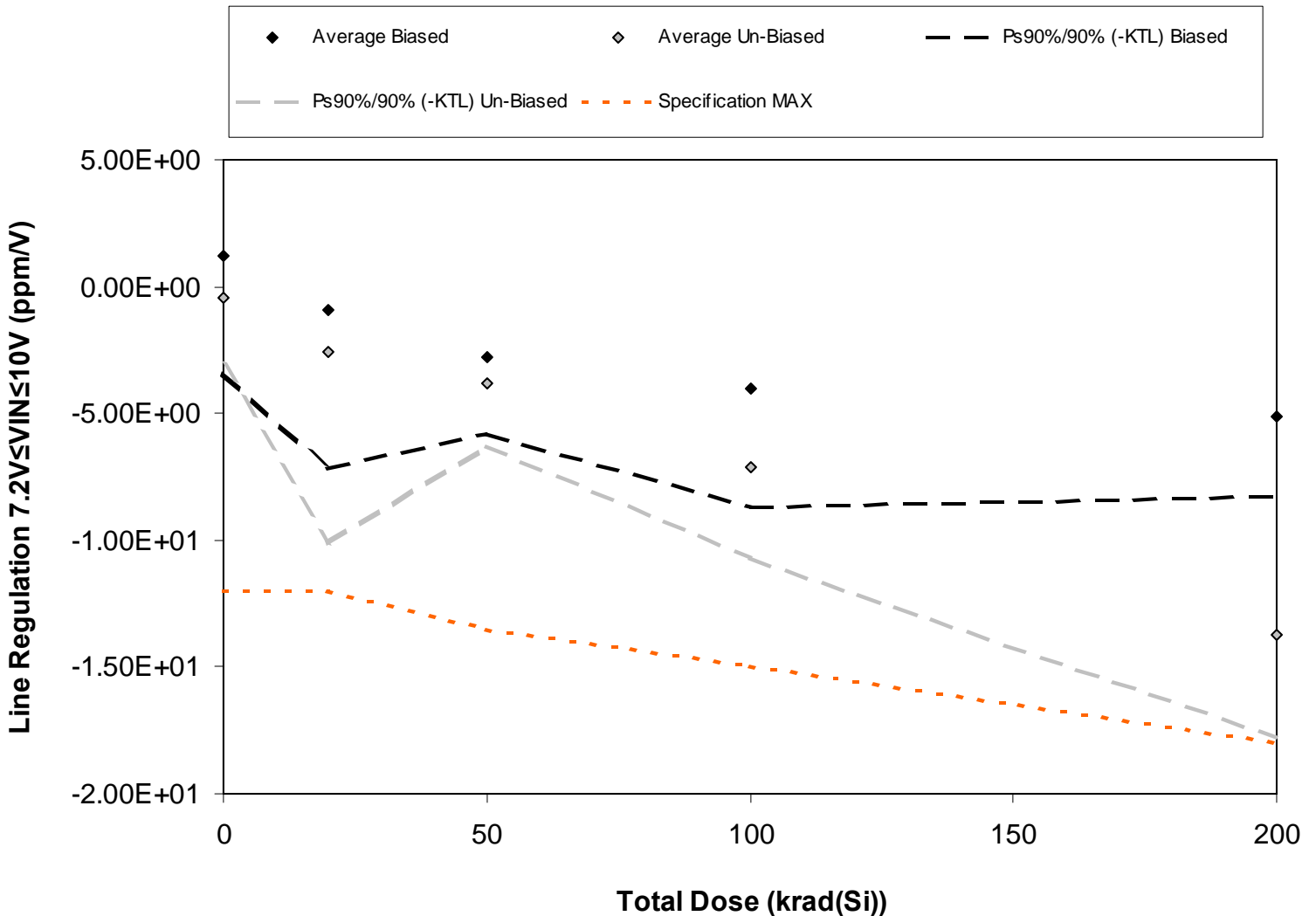

Figure 5.3. Plot of Line Regulation $7.2V \leq V_{IN} \leq 10V$ (ppm/V) versus total dose. The data shows degradation with radiation, however it is not sufficient to cause the parameter to fall below the specification value, even after application of the KTL statistics. The solid diamonds are the average of the measured data points for the sample irradiated under electrical bias while the shaded diamonds are the average of the measured data points for the units irradiated with all pins tied to ground. The black lines (solid and/or dashed) are the average of the data points after application of the KTL statistics on the sample irradiated under electrical bias while the gray lines (solid and/or dashed) are the average of the data points after application of the KTL statistics on the samples irradiated in the unbiased condition. The red dotted line(s) are the pre- and/or post-irradiation minimum and/or maximum specification value as defined in the datasheet and/or test plan.



Table 5.3. Raw data for Line Regulation $7.2V \leq V_{IN} \leq 10V$ (ppm/V) versus total dose, including the statistical analysis, specification and the status of the testing (pass/fail).

Line Regulation $7.2V \leq V_{IN} \leq 10V$ (ppm/V)	Total Dose (krad(Si))				
	0	20	50	100	200
Device					
14	-5.00E-01	-2.41E+00	-3.15E+00	-5.33E+00	-6.24E+00
15	1.53E+00	-3.54E+00	-8.20E-01	-4.68E+00	-3.81E+00
16	1.98E+00	-1.11E+00	-3.57E+00	-2.64E+00	-6.42E+00
17	-4.30E-01	0.00E+00	-3.33E+00	-5.68E+00	-4.72E+00
18	3.42E+00	2.39E+00	-2.95E+00	-1.78E+00	-4.35E+00
20	-5.00E-02	-1.10E+00	-5.08E+00	-5.86E+00	-1.24E+01
34	-2.03E+00	-1.99E+00	-3.74E+00	-8.54E+00	-1.20E+01
35	5.00E-01	-5.06E+00	-2.80E+00	-5.74E+00	-1.51E+01
36	-6.20E-01	-5.63E+00	-4.29E+00	-8.23E+00	-1.41E+01
37	9.00E-02	8.30E-01	-3.24E+00	-7.18E+00	-1.51E+01
38	1.54E+00	-1.38E+00	1.00E-02	2.20E+00	-6.30E-01
40	-2.30E+00	-6.10E-01	-3.00E-01	5.00E-01	2.72E+00
Biased Statistics					
Average Biased	1.20E+00	-9.34E-01	-2.76E+00	-4.02E+00	-5.11E+00
Std Dev Biased	1.67E+00	2.29E+00	1.11E+00	1.72E+00	1.16E+00
Ps90%/90% (+KTL) Biased	5.79E+00	5.34E+00	2.81E-01	6.93E-01	-1.92E+00
Ps90%/90% (-KTL) Biased	-3.39E+00	-7.21E+00	-5.81E+00	-8.74E+00	-8.30E+00
Un-Biased Statistics					
Average Un-Biased	-4.22E-01	-2.59E+00	-3.83E+00	-7.11E+00	-1.38E+01
Std Dev Un-Biased	9.84E-01	2.72E+00	8.93E-01	1.30E+00	1.47E+00
Ps90%/90% (+KTL) Un-Biased	2.28E+00	4.87E+00	-1.38E+00	-3.55E+00	-9.72E+00
Ps90%/90% (-KTL) Un-Biased	-3.12E+00	-1.01E+01	-6.28E+00	-1.07E+01	-1.78E+01
Specification MAX	-1.20E+01	-1.20E+01	-1.35E+01	-1.50E+01	-1.80E+01
Status	PASS	PASS	PASS	PASS	PASS

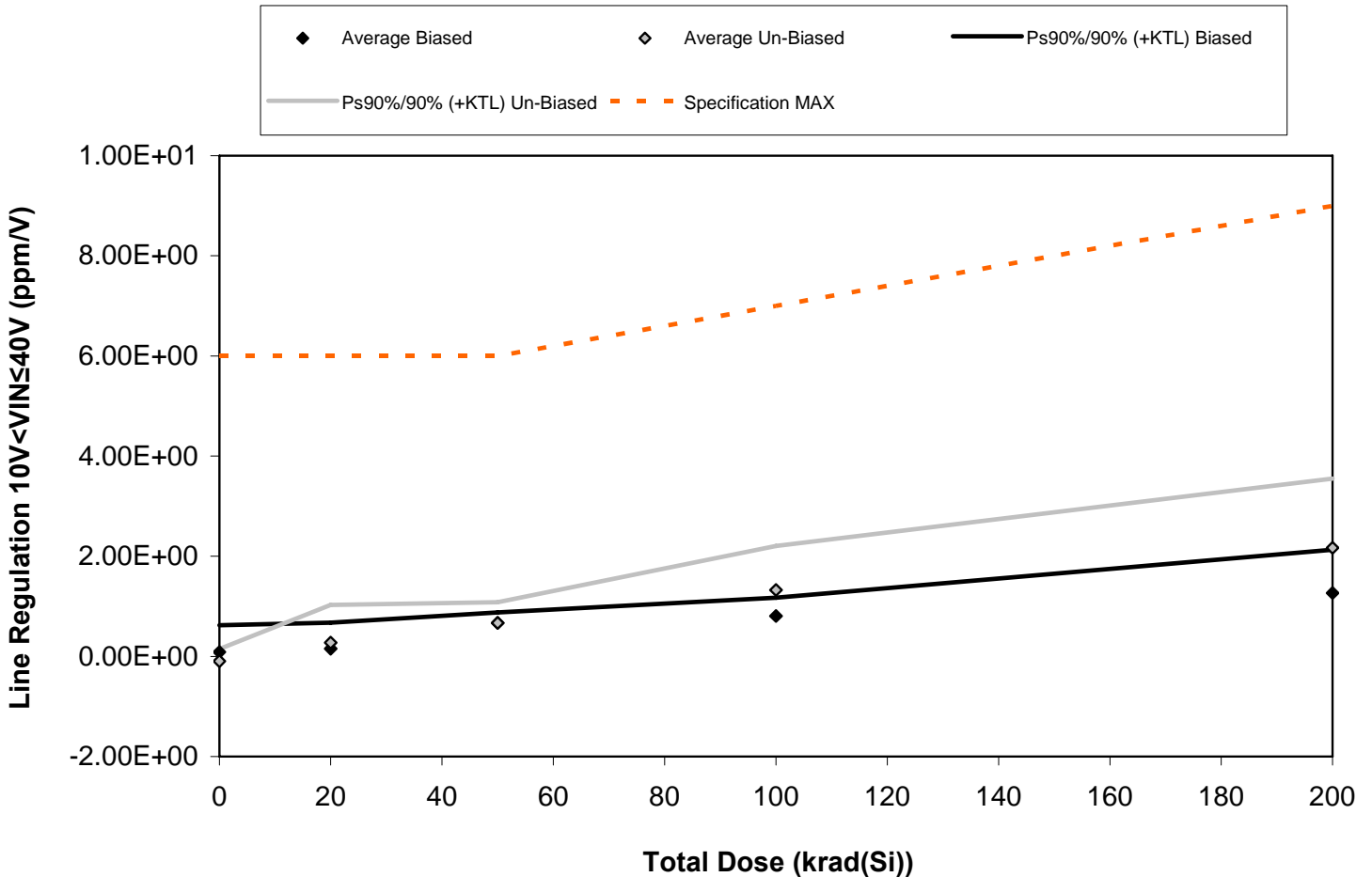

Figure 5.4. Plot of Line Regulation $10V < V_{IN} \leq 40V$ (ppm/V) versus total dose. The data shows some degradation with radiation, however it is not sufficient to cause the parameter to fall below the specification value, even after application of the KTL statistics. The solid diamonds are the average of the measured data points for the sample irradiated under electrical bias while the shaded diamonds are the average of the measured data points for the units irradiated with all pins tied to ground. The black lines (solid and/or dashed) are the average of the data points after application of the KTL statistics on the sample irradiated under electrical bias while the gray lines (solid and/or dashed) are the average of the data points after application of the KTL statistics on the samples irradiated in the unbiased condition. The red dotted line(s) are the pre-and/or post-irradiation minimum and/or maximum specification value as defined in the datasheet and/or test plan.



Table 5.4. Raw data for Line Regulation $10V < V_{IN} \leq 40V$ (ppm/V) versus total dose, including the statistical analysis, specification and the status of the testing (pass/fail).

Line Regulation $10V < V_{IN} \leq 40V$ (ppm/V)	Total Dose (krad(Si))				
	0	20	50	100	200
Device					
14	2.40E-01	2.80E-01	6.50E-01	9.30E-01	1.70E+00
15	-1.00E-01	3.80E-01	6.90E-01	8.20E-01	1.36E+00
16	-3.00E-02	-1.20E-01	6.00E-01	6.20E-01	1.15E+00
17	-2.00E-02	1.20E-01	7.90E-01	9.30E-01	1.29E+00
18	3.50E-01	1.00E-01	6.20E-01	7.20E-01	8.40E-01
20	-6.00E-02	2.60E-01	7.90E-01	1.21E+00	1.88E+00
34	-1.10E-01	3.60E-01	5.90E-01	1.08E+00	1.72E+00
35	4.00E-02	6.50E-01	5.70E-01	1.30E+00	2.01E+00
36	-1.80E-01	-1.10E-01	5.30E-01	1.15E+00	2.22E+00
37	-1.60E-01	2.20E-01	8.70E-01	1.88E+00	3.01E+00
38	2.00E-02	-1.90E-01	-1.40E-01	-7.00E-02	5.00E-02
40	-1.00E-01	1.00E-01	2.00E-02	-2.70E-01	1.20E-01
Biased Statistics					
Average Biased	8.80E-02	1.52E-01	6.70E-01	8.04E-01	1.27E+00
Std Dev Biased	1.95E-01	1.91E-01	7.52E-02	1.35E-01	3.13E-01
Ps90%/90% (+KTL) Biased	6.24E-01	6.76E-01	8.76E-01	1.17E+00	2.13E+00
Ps90%/90% (-KTL) Biased	-4.48E-01	-3.72E-01	4.64E-01	4.34E-01	4.09E-01
Un-Biased Statistics					
Average Un-Biased	-9.40E-02	2.76E-01	6.70E-01	1.32E+00	2.17E+00
Std Dev Un-Biased	8.82E-02	2.74E-01	1.50E-01	3.21E-01	5.05E-01
Ps90%/90% (+KTL) Un-Biased	1.48E-01	1.03E+00	1.08E+00	2.20E+00	3.55E+00
Ps90%/90% (-KTL) Un-Biased	-3.36E-01	-4.74E-01	2.58E-01	4.43E-01	7.83E-01
Specification MAX	6.00E+00	6.00E+00	6.00E+00	7.00E+00	9.00E+00
Status	PASS	PASS	PASS	PASS	PASS

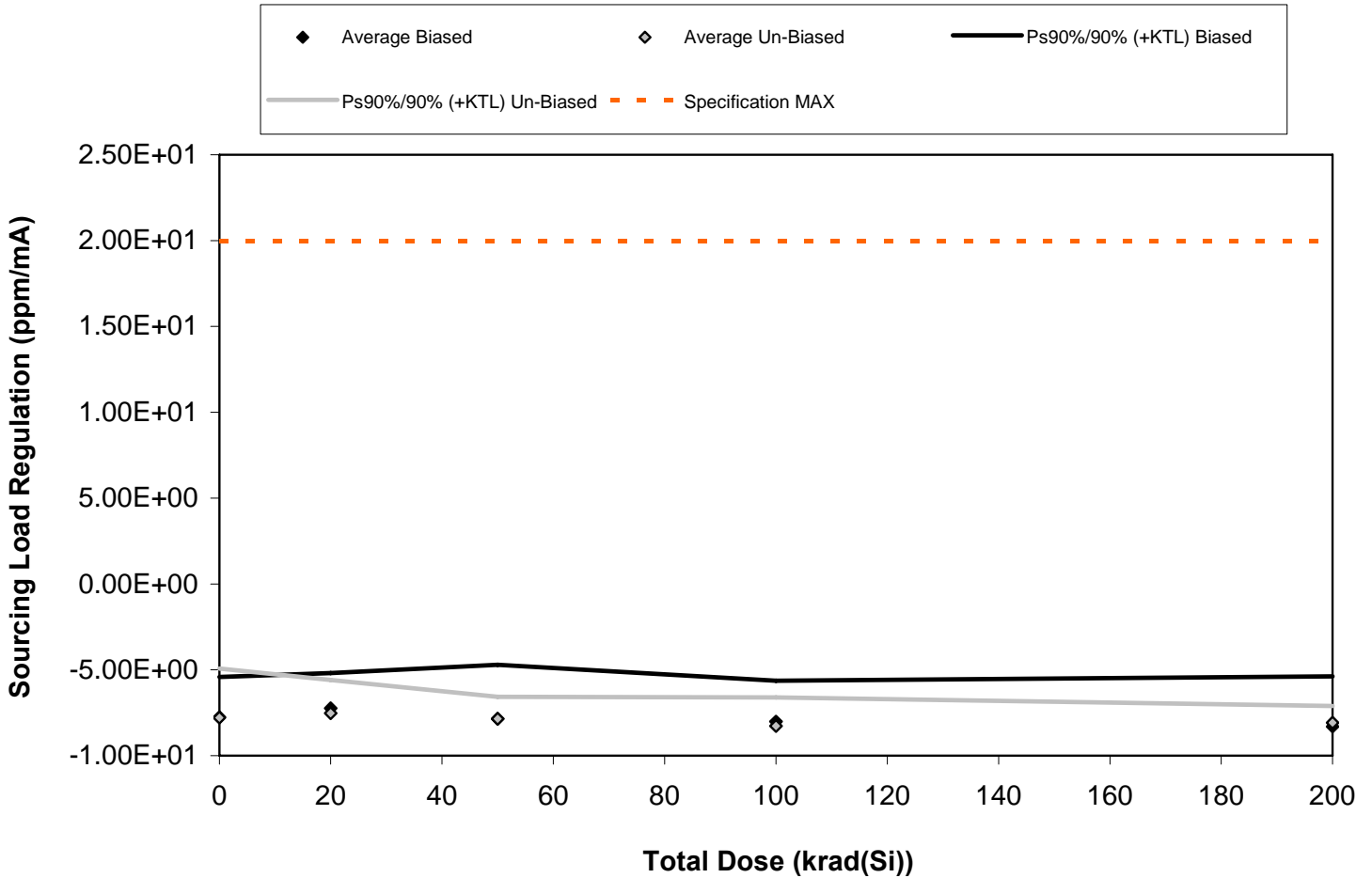

Figure 5.5. Plot of Sourcing Load Regulation (ppm/mA) versus total dose. The data show no significant change with total dose. The solid diamonds are the average of the measured data points for the sample irradiated under electrical bias while the shaded diamonds are the average of the measured data points for the units irradiated with all pins tied to ground. The black lines (solid and/or dashed) are the average of the data points after application of the KTL statistics on the sample irradiated under electrical bias while the gray lines (solid and/or dashed) are the average of the data points after application of the KTL statistics on the samples irradiated in the unbiased condition. The red dotted line(s) are the pre- and/or post-irradiation minimum and/or maximum specification value as defined in the datasheet and/or test plan.



Table 5.5. Raw data for Sourcing Load Regulation (ppm/mA) versus total dose, including the statistical analysis, specification and the status of the testing (pass/fail).

Sourcing Load Regulation (ppm/mA)	Total Dose (krad(Si))				
	0	20	50	100	200
Device					
14	-8.19E+00	-7.29E+00	-8.22E+00	-7.35E+00	-8.72E+00
15	-6.80E+00	-7.71E+00	-7.70E+00	-7.16E+00	-9.59E+00
16	-8.83E+00	-6.25E+00	-5.96E+00	-7.86E+00	-7.64E+00
17	-8.01E+00	-6.81E+00	-8.93E+00	-8.43E+00	-8.69E+00
18	-6.98E+00	-8.17E+00	-8.45E+00	-9.29E+00	-6.85E+00
20	-8.55E+00	-7.07E+00	-7.45E+00	-8.57E+00	-7.62E+00
34	-6.34E+00	-7.91E+00	-7.28E+00	-8.96E+00	-7.80E+00
35	-7.92E+00	-6.55E+00	-8.03E+00	-8.46E+00	-8.34E+00
36	-7.20E+00	-7.77E+00	-8.10E+00	-7.92E+00	-8.43E+00
37	-8.92E+00	-8.32E+00	-8.38E+00	-7.42E+00	-8.19E+00
38	-6.24E+00	-7.60E+00	-7.72E+00	-7.41E+00	-7.08E+00
40	-7.78E+00	-7.25E+00	-9.30E+00	-6.92E+00	-5.54E+00
Biased Statistics					
Average Biased	-7.76E+00	-7.25E+00	-7.85E+00	-8.02E+00	-8.30E+00
Std Dev Biased	8.55E-01	7.51E-01	1.15E+00	8.65E-01	1.06E+00
Ps90%/90% (+KTL) Biased	-5.42E+00	-5.19E+00	-4.71E+00	-5.65E+00	-5.38E+00
Ps90%/90% (-KTL) Biased	-1.01E+01	-9.30E+00	-1.10E+01	-1.04E+01	-1.12E+01
Un-Biased Statistics					
Average Un-Biased	-7.79E+00	-7.52E+00	-7.85E+00	-8.27E+00	-8.08E+00
Std Dev Un-Biased	1.04E+00	7.07E-01	4.64E-01	6.01E-01	3.51E-01
Ps90%/90% (+KTL) Un-Biased	-4.94E+00	-5.59E+00	-6.58E+00	-6.62E+00	-7.11E+00
Ps90%/90% (-KTL) Un-Biased	-1.06E+01	-9.46E+00	-9.12E+00	-9.92E+00	-9.04E+00
Specification MAX	2.00E+01	2.00E+01	2.00E+01	2.00E+01	2.00E+01
Status	PASS	PASS	PASS	PASS	PASS

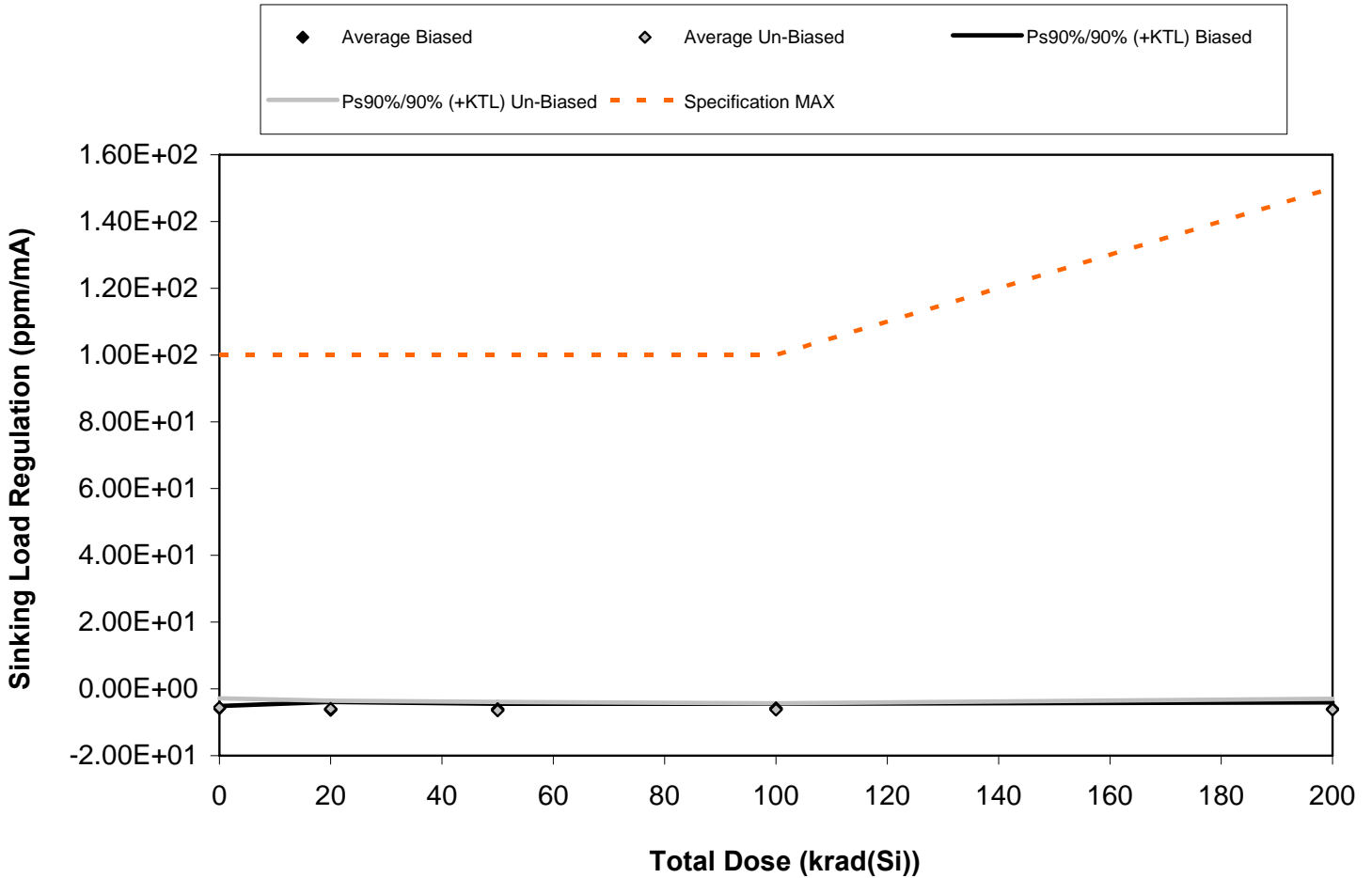

Figure 5.6. Plot of Sinking Load Regulation (ppm/mA) versus total dose. The data show no significant change with total dose. The solid diamonds are the average of the measured data points for the sample irradiated under electrical bias while the shaded diamonds are the average of the measured data points for the units irradiated with all pins tied to ground. The black lines (solid and/or dashed) are the average of the data points after application of the KTL statistics on the sample irradiated under electrical bias while the gray lines (solid and/or dashed) are the average of the data points after application of the KTL statistics on the samples irradiated in the unbiased condition. The red dotted line(s) are the pre- and/or post-irradiation minimum and/or maximum specification value as defined in the datasheet and/or test plan.



Table 5.6. Raw data for Sinking Load Regulation (ppm/mA) versus total dose, including the statistical analysis, specification and the status of the testing (pass/fail).

Sinking Load Regulation (ppm/mA)	Total Dose (krad(Si))				
	0	20	50	100	200
Device					
14	-5.76E+00	-5.94E+00	-6.72E+00	-6.32E+00	-5.27E+00
15	-5.80E+00	-5.30E+00	-5.14E+00	-6.29E+00	-6.39E+00
16	-6.24E+00	-6.04E+00	-5.97E+00	-5.13E+00	-5.81E+00
17	-5.76E+00	-6.46E+00	-6.02E+00	-5.83E+00	-5.37E+00
18	-5.52E+00	-7.64E+00	-6.22E+00	-5.54E+00	-6.94E+00
20	-5.55E+00	-4.75E+00	-5.45E+00	-5.86E+00	-6.25E+00
34	-6.23E+00	-6.10E+00	-5.53E+00	-5.15E+00	-7.90E+00
35	-5.38E+00	-6.49E+00	-6.78E+00	-6.85E+00	-6.52E+00
36	-6.82E+00	-5.48E+00	-6.79E+00	-6.60E+00	-5.03E+00
37	-4.07E+00	-7.05E+00	-7.59E+00	-6.49E+00	-5.19E+00
38	-5.70E+00	-5.24E+00	-6.16E+00	-3.54E+00	-5.15E+00
40	-5.79E+00	-5.15E+00	-5.75E+00	-4.55E+00	-5.89E+00
Biased Statistics					
Average Biased	-5.82E+00	-6.28E+00	-6.01E+00	-5.82E+00	-5.96E+00
Std Dev Biased	2.62E-01	8.68E-01	5.72E-01	5.06E-01	7.06E-01
Ps90%/90% (+KTL) Biased	-5.10E+00	-3.90E+00	-4.45E+00	-4.43E+00	-4.02E+00
Ps90%/90% (-KTL) Biased	-6.53E+00	-8.66E+00	-7.58E+00	-7.21E+00	-7.89E+00
Un-Biased Statistics					
Average Un-Biased	-5.61E+00	-5.97E+00	-6.43E+00	-6.19E+00	-6.18E+00
Std Dev Un-Biased	1.03E+00	8.92E-01	9.18E-01	6.86E-01	1.16E+00
Ps90%/90% (+KTL) Un-Biased	-2.77E+00	-3.53E+00	-3.91E+00	-4.31E+00	-3.00E+00
Ps90%/90% (-KTL) Un-Biased	-8.45E+00	-8.42E+00	-8.94E+00	-8.07E+00	-9.36E+00
Specification MAX	1.00E+02	1.00E+02	1.00E+02	1.00E+02	1.50E+02
Status	PASS	PASS	PASS	PASS	PASS



6.0. Summary / Conclusions

The total ionizing dose testing described in this final report was performed using the facilities at Radiation Assured Devices' Longmire Laboratories in Colorado Springs, CO. The high dose rate total ionizing dose (TID) source is a JLSA 84-21 irradiator modified to provide a panoramic exposure. The Co-60 rods are held in the base of the irradiator heavily shielded by lead, during the radiation exposures the rod is raised by an electronic timer/controller and the exposure is performed in air. The dose rate for this irradiator in this configuration ranges from $<1\text{rad(Si)/s}$ to a maximum of approximately 120rad(Si)/s , determined by the distance from the source.

The parametric data was obtained as "read and record" and all the raw data plus an attributes summary were presented in this report. The attributes data contains the average, standard deviation and the average with the KTL values applied. The KTL value used was 2.742 per MIL HDBK 814 using one-sided tolerance limits of 90/90 and a 5-piece sample size. Note that the following criteria was used to determine the outcome of the testing: following the radiation exposure each parameter had to pass the specification value and the average value for the five-piece sample must pass the specification value when the KTL limits are applied. If these conditions were not both satisfied following the radiation exposure, then the lot would be logged as an RLAT failure.

Based on these criteria, the RH1021CMH precision 5V reference PASSED the RLAT to the maximum tested dose level of 200krad(Si) with only the output voltage and line regulation parameters showing significant degradation. Both of the measured line regulation parameters and the output voltage parameter stayed within the post-irradiation specifications, even after application of the KTL statistics.



Appendix A: Photograph of device-under-test to show part markings





Appendix B: TID Bias Connections

Biased Samples:

Pin	Function	Connection / Bias
1	NC	NC
2	VIN	To 15V, 0.1 μ F decoupling to pin 4
3	NC	NC
4	GND	To -15V, 0.1 μ F decoupling to pin 2
5	TRIM	NC
6	VOUT	NC
7	NC	NC
8	NC	NC

Unbiased Samples:

Pin	Function	Connection / Bias
1	NC	GND
2	VIN	GND
3	NC	GND
4	GND	GND
5	TRIM	GND
6	VOUT	GND
7	NC	GND
8	NC	GND

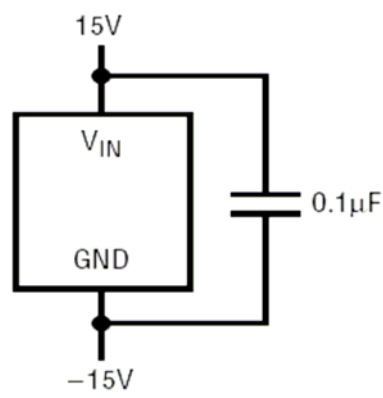

Figure B.1. Irradiation bias drawing for the units to be irradiated under electrical bias. This figure was extracted from LINEAR TECHNOLOGY CORPORATION, RH1021-5 Datasheet.

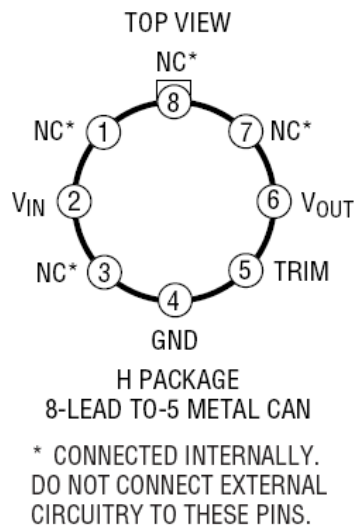

Figure B.2. H package drawing (for reference only). This figure was extracted from the LINEAR TECHNOLOGY CORPORATION RH1021-5 Datasheet.



Appendix C: Electrical Test Parameters and Conditions

All electrical tests for this device are performed on one of Radiation Assured Device's LTS2020 Test Systems. The LTS2020 Test System is a programmable parametric tester that provides parameter measurements for a variety of digital, analog and mixed signal products including voltage regulators, voltage comparators, D to A and A to D converters. The LTS2020 Test System achieves accuracy and sensitivity through the use of software self-calibration and an internal relay matrix with separate family boards and custom personality adapter boards. The tester uses this relay matrix to connect the required test circuits, select the appropriate voltage / current sources and establish the needed measurement loops for all the tests performed. The tests will be conducted using the LTS-2101 Linear Family Board, LTS-0600 Socket Assembly and the BGSS-030309 DUT board. The measured parameters and test conditions are shown in Tables C.1.

A listing of the measurement precision/resolution for each parameter is shown in Tables C.2. The precision/resolution values were obtained either from test data or from the DAC resolution of the LTS-2020. To generate the precision/resolution shown in Table C.2, one of the units-under-test was tested repetitively (a total of 10-times with re-insertion between tests) to obtain the average test value and standard deviation. Using this test data MIL-HDBK-814 90/90 KTL statistics were applied to the measured standard deviation to generate the final measurement range. This value encompasses the precision/resolution of all aspects of the test system, including the LTS2020 mainframe, family board, socket assembly and DUT board as well as insertion error. In some cases, the measurement resolution is limited by the internal DACs, which results in a measured standard deviation of zero. In these instances the precision/resolution will be reported back as the LSB of the DAC.

Note that the testing and statistics used in this document are based on an "analysis of variables" technique, which relies on small sample sizes to qualify much larger lot sizes (see MIL-HDBK-814, p. 91 for a discussion of statistical treatments). Not all measured parameters are well suited to this approach due to inherent large variations. If necessary, larger samples sizes could be used to qualify these parameters using an "attributes" approach.



Table C.1. Measured parameters and test conditions RH1021CMH-5.

TEST DESCRIPTION	TEST CONDITIONS
Supply Current	$V_{IN}=10V, I_{OUT}=0$
Output Voltage	$V_{IN}=10V, I_{OUT}=0$
Line Regulation $7.2V \leq V_{IN} \leq 10V$	$7.2V \leq V_{IN} \leq 10V$
Line Regulation $10V < V_{IN} \leq 40V$	$10V < V_{IN} \leq 40V$
Sourcing Load Regulation	$0 < I_{OUT} \leq 10mA$
Sinking Load Regulation	$0 < I_{OUT} \leq 10mA$

Table C.2. Measured parameters, pre-irradiation specifications and measurement resolutions for the RH1021CMH-5.

Measured Parameter	Pre-Irradiation Specification	Measurement Resolution/Precision
Supply Current	1.2mA MAX	$\pm 1.74E-05A$
Output Voltage	5V \pm 2.5mV	$\pm 6.53E-05V$
Line Regulation $7.2V \leq V_{IN} \leq 10V$	12ppm/V MAX	$\pm 1.64E+00ppm/V$
Line Regulation $10V < V_{IN} \leq 40V$	6ppm/V MAX	$\pm 1.71E-01ppm/V$
Sourcing Load Regulation	20ppm/mA MAX	$\pm 1.07E+00ppm/mA$
Sinking Load Regulation	100ppm/mA MAX	$\pm 9.53E-01ppm/mA$



Appendix D: List of Figures used in Section 5 (Total Ionizing Dose Test Results):

- 5.1 Supply Current (A)
- 5.2 Output Voltage (V)
- 5.3 Line Regulation $7.2V \leq V_{IN} \leq 10V$ (ppm/V)
- 5.4 Line Regulation $10V < V_{IN} \leq 40V$ (ppm/V)
- 5.5 Sourcing Load Regulation (ppm/mA)
- 5.6 Sinking Load Regulation (ppm/mA)