



Radiation Lot Acceptance Testing (RLAT) of the RH1013MJ8 Dual Precision Operational Amplifier for Linear Technology

Customer: Linear Technology, PO# 51419L

RAD Job Number: 08-402

Part Type Tested: Linear Technology RH1013MJ8 Dual Precision Operational Amplifier

Commercial Part Number: RH1013MJ8

Traceability Information: Fab # WR0246269, Wafer 8. Information obtained from Linear Technology PO#51419L. Date code marking on the package is 0548A, see Appendix B for a photograph of the device and part markings.

Quantity of Units: 12 units total, 5 units for biased irradiation, 5 units for unbiased irradiation (all pins tied to ground) and 2 control units. Serial numbers 1090, 1092, 1093, 1094, and 1095 were biased during irradiation. Serial numbers 1096, 1097, 1098, 1099 and 1100 were unbiased during irradiation (all pins tied to ground). Serial numbers 1106 and 1113 were used as controls.

External Traveler: None required

Pre-Irradiation Burn-In: Burn-In performed by Linear Devices prior to receipt by RAD.

TID Dose Rate and Test Increments: 68.8rad(Si)/s with test increments at: Pre-Irradiation, 20krad(Si), 50krad(Si), 100krad(Si) and 200krad(Si).

TID Overtest and Post-Irradiation Anneal: No overtest or anneal.

TID Test Standard: MIL-STD-883G, Method 1019.7, Condition A

TID Electrical Test Conditions: Pre-irradiation, and within one hour following each radiation exposure.

Test Programs: RH1013LT.SRC

Hardware: LTS2020 Tester, 2100 Family Board, 0600 Fixture and RH1013 DUT Board

Facility and Radiation Source: Radiation Assured Devices Longmire Laboratories, Colorado Springs, CO using the JLSA 81-24 high dose rate Co60 source. Dosimetry performed by CaF TLDs traceable to NIST. RAD's dosimetry has been audited by DSCC and RAD has been awarded Laboratory Suitability for MIL-STD-750 TM 1019.5.

Irradiation and Test Temperature: Ambient, room temperature



1.0. Overview and Background

It is well known that total dose ionizing radiation can cause parametric degradation and ultimately functional failure in electronic devices. The damage occurs via electron-hole pair production, transport and trapping in the dielectric and interface regions. In discrete devices the bulk of the damage is frequently manifested as a reduction in the gain and/or breakdown voltage of the device. The damage will usually anneal with time following the end of the radiation exposure. Due to this annealing, and to ensure a worst-case test condition MIL-STD-883 TM1019.7 calls out a dose rate of 50 to 300rad(Si)/s as Condition A and further specifies that the time from the end of an incremental radiation exposure and electrical testing shall be 1-hour or less and the total time from the end of one incremental irradiation to the beginning of the next incremental radiation step should be 2-hours or less. The work described in this report was performed to meet MIL-STD-883 TM1019.7 Condition A.

2.0. Radiation Test Apparatus

The total ionizing dose testing described in this final report was performed using the facilities at Radiation Assured Devices' Longmire Laboratories in Colorado Springs, CO. The high dose rate total ionizing dose (TID) source is a JLSA 84-21 irradiator modified to provide a panoramic exposure. The Co-60 rods are held in the base of the irradiator heavily shielded by lead, during the radiation exposures the rod is raised by an electronic timer/controller and the exposure is performed in air. The dose rate for this irradiator in this configuration ranges from <1rad(Si)/s to a maximum of approximately 120rad(Si)/s, determined by the distance from the source. For high-dose rate experiments the bias boards are placed in a radial fashion equidistant from the raised Co-60 rods with the distance adjusted to provide the required dose rate. The irradiator calibration is maintained by Radiation Assured Devices Longmire Laboratories using thermoluminescent dosimeters (TLDs)) traceable to the National Institute of Standards and Technology (NIST). Figure 2.1 shows a photograph of the JLSA 81-24 Co-60 irradiator at RAD's Longmire Laboratory facility.

RAD is currently certified by the Defense Supply Center Columbus (DSCC) for Laboratory Suitability under MIL STD 750. Additional details regarding Radiation Assured Devices dosimetry for TM1019 Condition A testing are available in RAD's report to DSCC entitled: "Dose Rate Mapping of the J.L. Shepherd and Associates Model 81 Irradiator Installed by Radiation Assured Devices"



Figure 2.1. Radiation Assured Devices' high dose rate Co-60 irradiator. The dose rate is obtained by positioning the device-under-test at a fixed distance from the gamma cell. The dose rate for this irradiator varies from approximately 120rad(Si)/s close to the rods down to 1rad(Si)/s at a distance of approximately 2-feet.

An ISO 9001:2000 Certified Company



3.0. Radiation Test Conditions

The RH1013 dual operational amplifiers described in this final report were irradiated using a split 15V supply and with all pins tied to ground, that is biased and unbiased. See the TID Bias Table in Appendix A for the full bias circuits. These bias circuits satisfy the requirements of MIL-STD-883G TM1019.7 Section 3.9.3 Bias and Loading Conditions which states “The bias applied to the test devices shall be selected to produce the greatest radiation induced damage or the worst-case damage for the intended application, if known. While maximum voltage is often worst case some bipolar linear device parameters (e.g. input bias current or maximum output load current) exhibit more degradation with 0 V bias.”

The devices were irradiated to a maximum total ionizing dose level of 200krad(Si) with incremental readings at 20, 50, 100 and 200krad(Si) for all electrical tests using the $\pm 15V$ supply and with incremental readings at 20, 50 and 100krad(Si) for all electrical tests using the +5V and 0V supply conditions (See LINEAR TECHNOLOGY CORPORATION RH1013M Dual Precision Operational Amplifier Datasheet Page 3, Note 2). Electrical testing occurred within one hour following the end of each irradiation segment. For intermediate irradiations, the parts were tested and returned to total dose exposure within two hours from the end of the previous radiation increment.

The TID bias board was positioned in the Co-60 cell to provide the required minimum of 50rad(Si)/s and was located inside a lead-aluminum enclosure. The lead-aluminum enclosure is required under MIL-STD-883G TM1019.7 Section 3.4 that reads as follows: “Lead/Aluminum (Pb/Al) container. Test specimens shall be enclosed in a Pb/Al container to minimize dose enhancement effects caused by low-energy, scattered radiation. A minimum of 1.5 mm Pb, surrounding an inner shield of at least 0.7 mm Al, is required. This Pb/Al container produces an approximate charged particle equilibrium for Si and for TLDs such as CaF₂. The radiation field intensity shall be measured inside the Pb/Al container (1) initially, (2) when the source is changed, or (3) when the orientation or configuration of the source, container, or test-fixture is changed. This measurement shall be performed by placing a dosimeter (e.g., a TLD) in the device-irradiation container at the approximate test-device position. If it can be demonstrated that low energy scattered radiation is small enough that it will not cause dosimetry errors due to dose enhancement, the Pb/Al container may be omitted”.

The final dose rate within the high dose rate lead-aluminum enclosure was determined based on TLD dosimetry measurements (see previous section). The final dose rate for this work was 68.8rad(Si)/s with a precision of $\pm 5\%$.



4.0. Tested Parameters

During the radiation lot acceptance testing the pre- and post-irradiation electrical parameters measured were:

±15V Tests

1. Positive Supply Current (I_{CC+})
2. Negative Supply Current (I_{EE-})
3. Input Offset Voltage (V_{OS} Channel A and B)
4. Input Offset Current (I_{OS} Channel A and B)
5. + Input Bias Current (I_{B+} Channel A and B)
6. - Input Bias Current (I_{B-} Channel A and B)
7. Common Mode Rejection Ratio (CMRR Channel A and B)
8. Power Supply Rejection Ratio (PSRR Channel A and B)
9. Large Signal Voltage Gain (A_{VOL} Channel A and B)
10. Positive Output Voltage Swing, No Load (V_{OUT} Channel A and B)
11. Positive Output Voltage Swing, 600 Ω (V_{OUT} Channel A and B)
12. Negative Output Voltage Swing, No Load (V_{OUT} Channel A and B)
13. Negative Output Voltage Swing, 600 Ω (V_{OUT} Channel A and B)
14. Positive Slew Rate (SlewRate+ Channel A and B)
15. Negative Slew Rate (SlewRate- Channel A and B)

+5V Tests

16. Positive Supply Current (I_{CC+2})
17. Negative Supply Current (I_{EE-2})
18. Input Offset Voltage (V_{OS} Channel A and B)
19. Input Offset Current (I_{OS} Channel A and B)
20. + Input Bias Current (I_{B+} Channel A and B)
21. - Input Bias Current (I_{B-} Channel A and B)
22. Output Voltage High, No Load (V_{OUT} Channel A and B)
23. Output Voltage High, 600 Ω (V_{OUT} Channel A and B)
24. Output Voltage Low, No Load (V_{OUT} Channel A and B)
25. Output Voltage Low, 600 Ω (V_{OUT} Channel A and B)
26. Output Voltage Low, 1mA (V_{OUT} Channel A and B)

The parametric data was obtained as read and record and all the raw data plus an attributes summary are contained in a separate Excel file. The attributes data contains the average, standard deviation and the average with the KTL values applied. The KTL value used is 2.742 per MIL HDBK 814 using one sided tolerance limits of 90/90 and a 5-piece sample size. Note that the following criteria must be met for a device to pass the RLAT: following the radiation exposure each of the 5 pieces shall pass the



specification value and the average value for the ten-piece sample must pass the specification value when the KTL limits are applied. If either of these conditions is not satisfied following the radiation exposure, then the lot could be logged as a failure.

5.0. Total Ionizing Dose Test Results

The RH1013 operational amplifiers passed the RLAT to the maximum tested level of 200krad(Si) without any significant degradation to most of the measured parameters. As seen in the data plots, several parameters suffered measurable radiation-induced degradation, however in no case was it sufficient to cause the parameters to go out of specification even after application of the KTL statistics. Figures 5.1 and 5.44 show plots of all the measured parameters versus total ionizing dose while Tables 5.1 – 5.44 show the corresponding raw data for each of these parameters. Note that Large Signal Voltage Gain data is presented in both V/mV and dB units. The V/mV plots are in Figures 5.15 and 5.16 with the corresponding raw data in Tables 5.15 and 5.16. The dB plots and raw data are in Appendix D.

In the data plots the solid diamonds are the average of the measured data points for the sample irradiated under electrical bias while the shaded diamonds are the average of the measured data points for the units irradiated with all pins tied to ground. The black lines (solid or dashed) are the average of the data points after application of the KTL statistics on the sample irradiated in the biased condition while the shaded lines (solid or dashed) are the average of the data points after application of the KTL statistics on the sample irradiated in the unbiased condition. The red dotted line(s) are the pre- and/or post-irradiation minimum and/or maximum specification value as defined in the datasheet and/or test plan.

The control units, as expected, show no significant changes to any of the parameters. Therefore we can conclude that the electrical testing remained in control throughout the duration of the tests and the minor observed degradation was due to the radiation exposure.

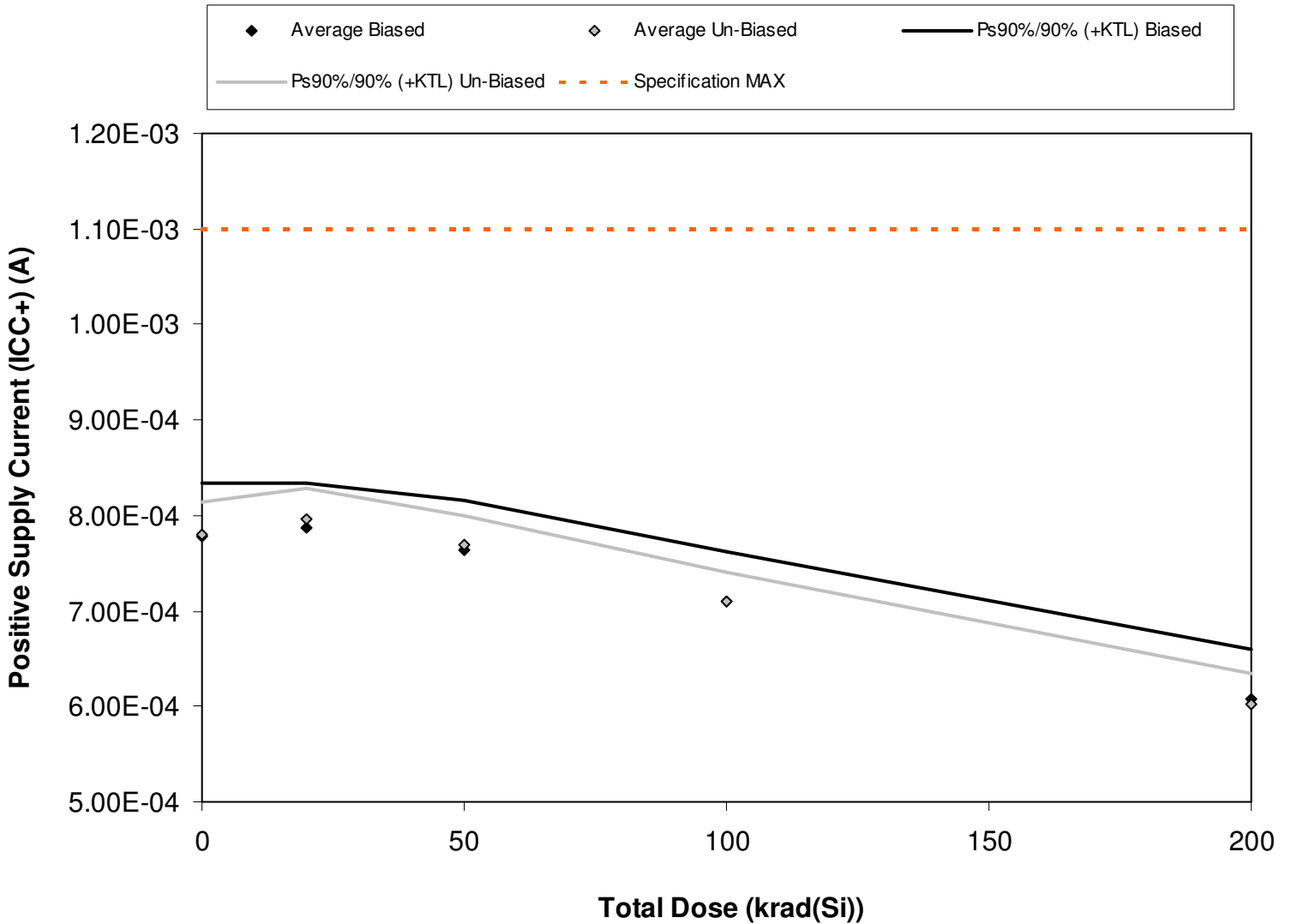

Figure 5.1. Plot of positive supply current ($\pm 15V$) versus total dose. The data shows a general improvement with total dose. The solid diamonds are the average of the measured data points for the sample irradiated under electrical bias while the shaded diamonds are the average of the measured data points for the units irradiated with all pins tied to ground. The black lines (solid or dashed) are the average of the data points after application of the KTL statistics on the sample irradiated in the biased condition while the shaded lines (solid or dashed) are the average of the data points after application of the KTL statistics on the sample irradiated in the unbiased condition. The red dotted line(s) are the pre- and/or post-irradiation minimum and/or maximum specification value as defined in the datasheet and/or test plan.



Table 5.1. Raw data of the Positive Supply Current @ +/-15V (A) versus total dose, including the statistical analysis, the specification and the status of the testing (pass/fail).

Positive Supply Current (ICC+) (A)	Total Dose (krad(Si))				
	0	20	50	100	200
Device					
1090	7.71E-04	7.80E-04	7.59E-04	7.01E-04	5.94E-04
1092	7.93E-04	8.01E-04	7.78E-04	7.22E-04	6.18E-04
1093	7.72E-04	7.81E-04	7.62E-04	7.11E-04	6.11E-04
1094	7.54E-04	7.64E-04	7.37E-04	6.83E-04	5.84E-04
1095	8.05E-04	8.07E-04	7.85E-04	7.33E-04	6.32E-04
1096	7.89E-04	8.10E-04	7.82E-04	7.23E-04	6.17E-04
1097	7.68E-04	7.83E-04	7.55E-04	6.97E-04	6.04E-04
1098	7.66E-04	7.84E-04	7.62E-04	7.16E-04	6.09E-04
1099	7.91E-04	8.03E-04	7.76E-04	7.15E-04	5.95E-04
1100	7.88E-04	8.01E-04	7.72E-04	7.03E-04	5.87E-04
1106	7.70E-04	7.72E-04	7.73E-04	7.73E-04	7.71E-04
1113	7.95E-04	7.94E-04	7.95E-04	7.95E-04	7.91E-04
Biased Statistics					
Average Biased	7.79E-04	7.87E-04	7.64E-04	7.10E-04	6.08E-04
Std Dev Biased	2.01E-05	1.74E-05	1.87E-05	1.93E-05	1.91E-05
Ps90%/90% (+KTL) Biased	8.34E-04	8.34E-04	8.15E-04	7.63E-04	6.60E-04
Ps90%/90% (-KTL) Biased	7.24E-04	7.39E-04	7.13E-04	6.57E-04	5.55E-04
Un-Biased Statistics					
Average Un-Biased	7.80E-04	7.96E-04	7.69E-04	7.11E-04	6.02E-04
Std Dev Un-Biased	1.23E-05	1.21E-05	1.09E-05	1.05E-05	1.17E-05
Ps90%/90% (+KTL) Un-Biased	8.14E-04	8.29E-04	7.99E-04	7.40E-04	6.35E-04
Ps90%/90% (-KTL) Un-Biased	7.47E-04	7.63E-04	7.40E-04	6.82E-04	5.70E-04
Specification MAX	1.10E-03	1.10E-03	1.10E-03	1.10E-03	1.10E-03
Status	PASS	PASS	PASS	PASS	PASS

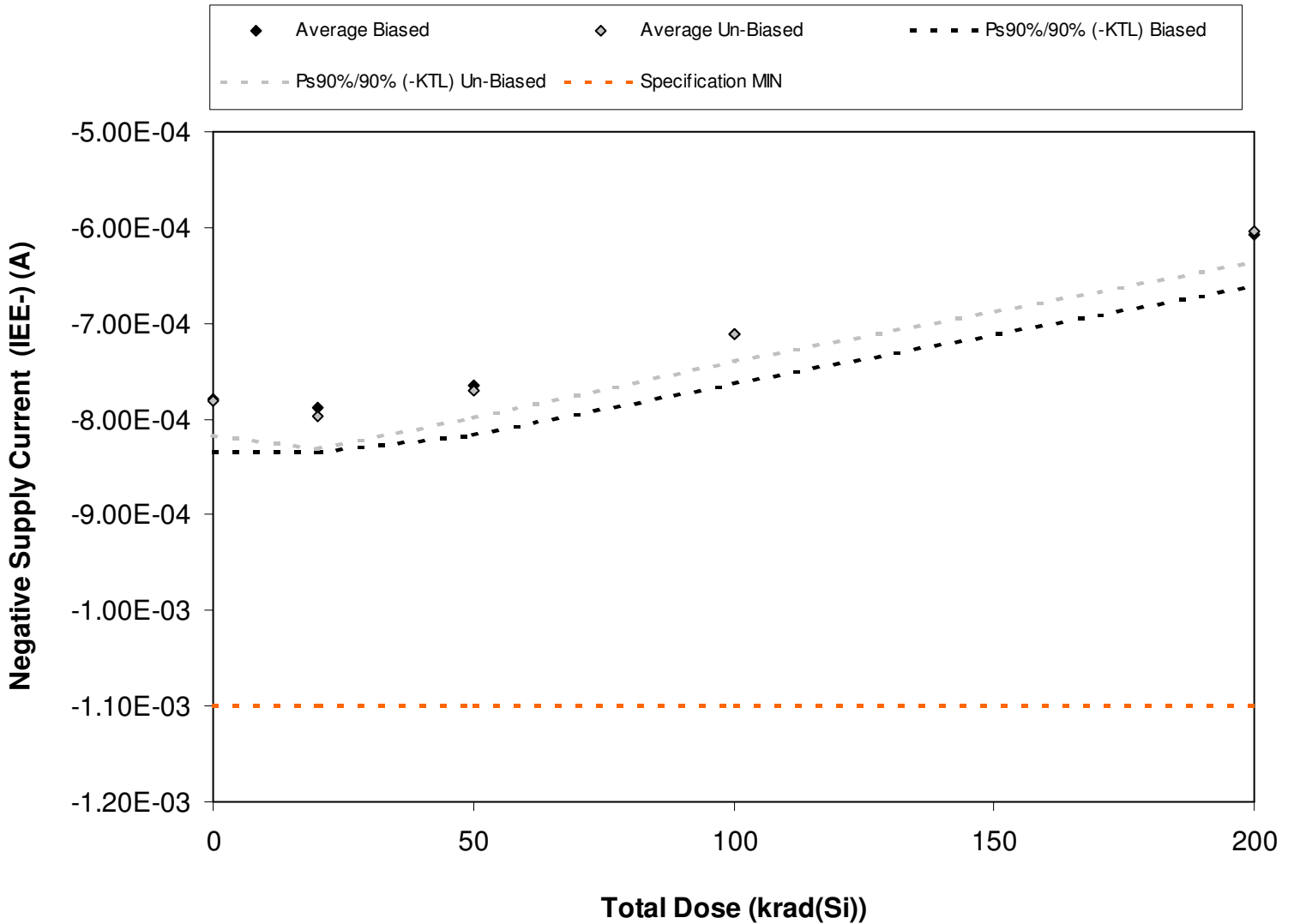

Figure 5.2. Plot of Negative Supply Current @ +/-15V (A) versus total dose. The data show a general improvement with total dose. The solid diamonds are the average of the measured data points for the sample irradiated under electrical bias while the shaded diamonds are the average of the measured data points for the units irradiated with all pins tied to ground. The black lines (solid or dashed) are the average of the data points after application of the KTL statistics on the sample irradiated in the biased condition while the shaded lines (solid or dashed) are the average of the data points after application of the KTL statistics on the sample irradiated in the unbiased condition. The red dotted line(s) are the pre- and/or post-irradiation minimum and/or maximum specification value as defined in the datasheet and/or test plan.



Table 5.2. Raw data for the Negative Supply Current @ +/-15V (A) versus total dose, including the statistical analysis, the specification and the status of the testing (pass/fail).

Negative Supply Current (IEE-) (A)	Total Dose (krad(Si))				
	0	20	50	100	200
Device					
1090	-7.71E-04	-7.79E-04	-7.60E-04	-7.03E-04	-5.94E-04
1092	-7.94E-04	-8.00E-04	-7.79E-04	-7.22E-04	-6.17E-04
1093	-7.73E-04	-7.83E-04	-7.63E-04	-7.11E-04	-6.12E-04
1094	-7.53E-04	-7.66E-04	-7.37E-04	-6.83E-04	-5.85E-04
1095	-8.04E-04	-8.09E-04	-7.85E-04	-7.33E-04	-6.33E-04
1096	-7.90E-04	-8.11E-04	-7.82E-04	-7.23E-04	-6.19E-04
1097	-7.68E-04	-7.83E-04	-7.56E-04	-6.98E-04	-6.04E-04
1098	-7.65E-04	-7.85E-04	-7.63E-04	-7.18E-04	-6.10E-04
1099	-7.92E-04	-8.04E-04	-7.76E-04	-7.16E-04	-5.97E-04
1100	-7.88E-04	-8.01E-04	-7.73E-04	-7.05E-04	-5.88E-04
1106	-7.72E-04	-7.71E-04	-7.74E-04	-7.71E-04	-7.71E-04
1113	-7.96E-04	-7.96E-04	-7.95E-04	-7.94E-04	-7.94E-04
Biased Statistics					
Average Biased	-7.79E-04	-7.87E-04	-7.65E-04	-7.10E-04	-6.08E-04
Std Dev Biased	2.02E-05	1.71E-05	1.88E-05	1.90E-05	1.90E-05
Ps90%/90% (+KTL) Biased	-7.24E-04	-7.40E-04	-7.13E-04	-6.58E-04	-5.56E-04
Ps90%/90% (-KTL) Biased	-8.34E-04	-8.34E-04	-8.16E-04	-7.63E-04	-6.60E-04
Un-Biased Statistics					
Average Un-Biased	-7.81E-04	-7.97E-04	-7.70E-04	-7.12E-04	-6.04E-04
Std Dev Un-Biased	1.30E-05	1.23E-05	1.04E-05	1.02E-05	1.19E-05
Ps90%/90% (+KTL) Un-Biased	-7.45E-04	-7.63E-04	-7.41E-04	-6.84E-04	-5.71E-04
Ps90%/90% (-KTL) Un-Biased	-8.16E-04	-8.30E-04	-7.99E-04	-7.40E-04	-6.36E-04
Specification MIN	-1.10E-03	-1.10E-03	-1.10E-03	-1.10E-03	-1.10E-03
Status	PASS	PASS	PASS	PASS	PASS

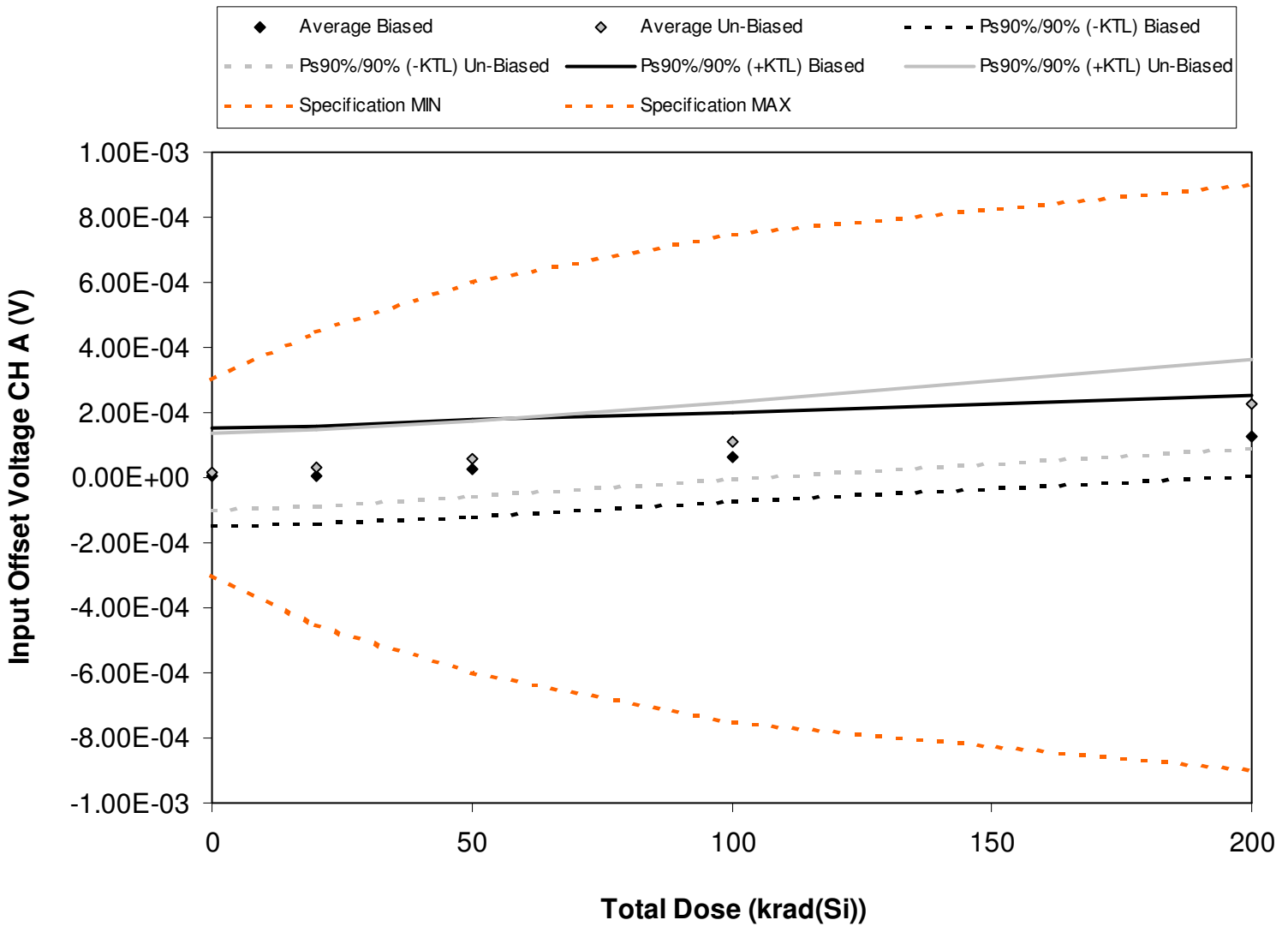

Figure 5.3. Plot of input offset voltage for channel A @ +/-15V (A) versus total dose. The data show some increase with total dose. The solid diamonds are the average of the measured data points for the sample irradiated under electrical bias while the shaded diamonds are the average of the measured data points for the units irradiated with all pins tied to ground. The black lines (solid or dashed) are the average of the data points after application of the KTL statistics on the sample irradiated in the biased condition while the shaded lines (solid or dashed) are the average of the data points after application of the KTL statistics on the sample irradiated in the unbiased condition. The red dotted line(s) are the pre- and/or post-irradiation minimum and/or maximum specification value as defined in the datasheet and/or test plan



Table 5.3. Raw data of input offset voltage for channel A @ +/-15V (A) versus total dose, including the statistical analysis, the specification and the status of the testing (pass/fail).

Input Offset Voltage CH A (V)	Total Dose (krad(Si))				
	0	20	50	100	200
Device					
1090	-6.16E-06	-1.33E-06	1.59E-05	5.23E-05	1.25E-04
1092	2.05E-05	2.44E-05	4.60E-05	7.69E-05	1.33E-04
1093	8.64E-05	9.04E-05	1.12E-04	1.34E-04	1.83E-04
1094	-4.35E-05	-3.39E-05	-7.48E-06	4.67E-05	1.42E-04
1095	-4.29E-05	-4.83E-05	-2.78E-05	-1.69E-06	5.69E-05
1096	6.17E-05	7.49E-05	9.85E-05	1.47E-04	2.36E-04
1097	5.42E-05	6.68E-05	9.62E-05	1.58E-04	2.78E-04
1098	7.20E-07	1.05E-05	3.59E-05	7.70E-05	1.60E-04
1099	-4.38E-05	-3.13E-05	-2.05E-06	6.06E-05	1.87E-04
1100	1.92E-05	2.40E-05	5.67E-05	1.20E-04	2.61E-04
1106	1.24E-04	1.27E-04	1.29E-04	1.25E-04	1.22E-04
1113	-1.37E-05	-1.38E-05	-1.03E-05	-1.16E-05	-9.90E-06
Biased Statistics					
Average Biased	2.87E-06	6.25E-06	2.78E-05	6.17E-05	1.28E-04
Std Dev Biased	5.39E-05	5.49E-05	5.46E-05	4.96E-05	4.54E-05
Ps90%/90% (+KTL) Biased	1.51E-04	1.57E-04	1.78E-04	1.98E-04	2.52E-04
Ps90%/90% (-KTL) Biased	-1.45E-04	-1.44E-04	-1.22E-04	-7.43E-05	3.24E-06
Un-Biased Statistics					
Average Un-Biased	1.84E-05	2.90E-05	5.71E-05	1.12E-04	2.24E-04
Std Dev Un-Biased	4.29E-05	4.34E-05	4.24E-05	4.26E-05	4.97E-05
Ps90%/90% (+KTL) Un-Biased	1.36E-04	1.48E-04	1.73E-04	2.29E-04	3.61E-04
Ps90%/90% (-KTL) Un-Biased	-9.91E-05	-9.00E-05	-5.92E-05	-4.29E-06	8.80E-05
Specification MIN	-3.00E-04	-4.50E-04	-6.00E-04	-7.50E-04	-9.00E-04
Status	PASS	PASS	PASS	PASS	PASS
Specification MAX	3.00E-04	4.50E-04	6.00E-04	7.50E-04	9.00E-04
Status	PASS	PASS	PASS	PASS	PASS

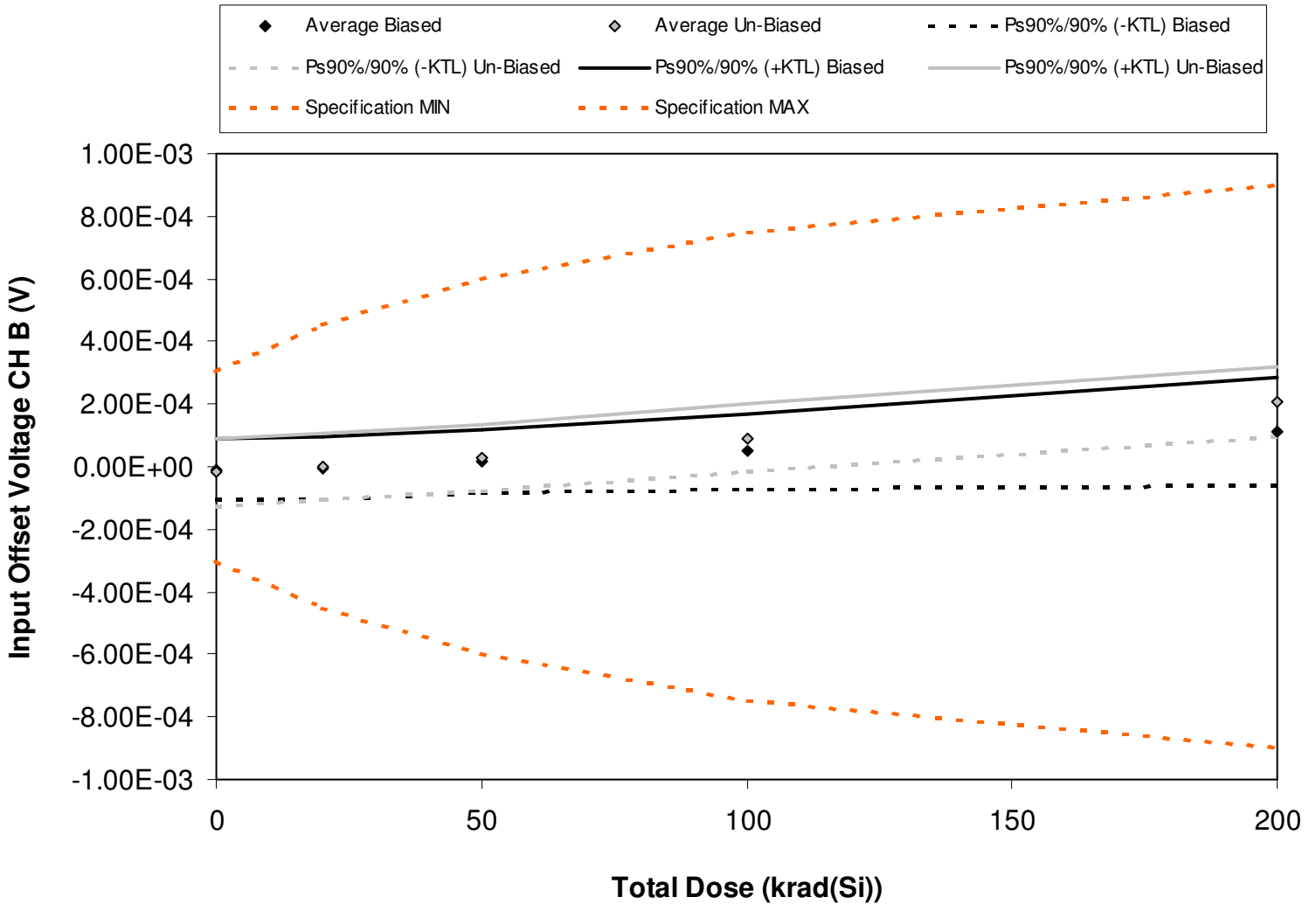

Figure 5.4. Plot of input offset voltage for channel B @ +/-15V (A) versus total dose. The data show some increase with total dose. The solid diamonds are the average of the measured data points for the sample irradiated under electrical bias while the shaded diamonds are the average of the measured data points for the units irradiated with all pins tied to ground. The black lines (solid or dashed) are the average of the data points after application of the KTL statistics on the sample irradiated in the biased condition while the shaded lines (solid or dashed) are the average of the data points after application of the KTL statistics on the sample irradiated in the unbiased condition. The red dotted line(s) are the pre- and/or post-irradiation minimum and/or maximum specification value as defined in the datasheet and/or test plan.



Table 5.4. Raw data of input offset voltage for channel B @ +/-15V (A) versus total dose, including the statistical analysis, the specification and the status of the testing (pass/fail).

Input Offset Voltage CH B (V)	Total Dose (krad(Si))				
	0	20	50	100	200
Device					
1090	3.65E-05	4.13E-05	6.79E-05	1.08E-04	1.82E-04
1092	-3.26E-06	3.98E-06	1.68E-05	4.27E-05	9.25E-05
1093	-7.13E-06	-6.88E-06	1.45E-06	3.19E-05	7.04E-05
1094	-9.78E-06	-3.98E-06	2.52E-05	7.05E-05	1.70E-04
1095	-6.43E-05	-6.28E-05	-3.40E-05	-1.07E-05	3.90E-05
1096	1.85E-05	3.16E-05	6.22E-05	1.24E-04	2.24E-04
1097	8.33E-06	3.10E-05	6.57E-05	1.36E-04	2.69E-04
1098	5.19E-06	1.69E-05	4.00E-05	9.57E-05	1.84E-04
1099	-6.34E-05	-4.25E-05	-1.30E-05	4.60E-05	1.64E-04
1100	-5.97E-05	-4.27E-05	-1.11E-05	5.71E-05	1.98E-04
1106	1.30E-05	1.21E-05	1.06E-05	1.01E-05	1.34E-05
1113	4.83E-06	4.59E-06	4.59E-06	2.05E-06	4.11E-06
Biased Statistics					
Average Biased	-9.59E-06	-5.67E-06	1.55E-05	4.85E-05	1.11E-04
Std Dev Biased	3.59E-05	3.73E-05	3.70E-05	4.43E-05	6.26E-05
Ps90%/90% (+KTL) Biased	8.88E-05	9.66E-05	1.17E-04	1.70E-04	2.82E-04
Ps90%/90% (-KTL) Biased	-1.08E-04	-1.08E-04	-8.61E-05	-7.29E-05	-6.09E-05
Un-Biased Statistics					
Average Un-Biased	-1.82E-05	-1.13E-06	2.87E-05	9.18E-05	2.08E-04
Std Dev Un-Biased	3.99E-05	3.83E-05	3.85E-05	3.98E-05	4.04E-05
Ps90%/90% (+KTL) Un-Biased	9.11E-05	1.04E-04	1.34E-04	2.01E-04	3.18E-04
Ps90%/90% (-KTL) Un-Biased	-1.28E-04	-1.06E-04	-7.69E-05	-1.73E-05	9.71E-05
Specification MIN	-3.00E-04	-4.50E-04	-6.00E-04	-7.50E-04	-9.00E-04
Status	PASS	PASS	PASS	PASS	PASS
Specification MAX	3.00E-04	4.50E-04	6.00E-04	7.50E-04	9.00E-04
Status	PASS	PASS	PASS	PASS	PASS

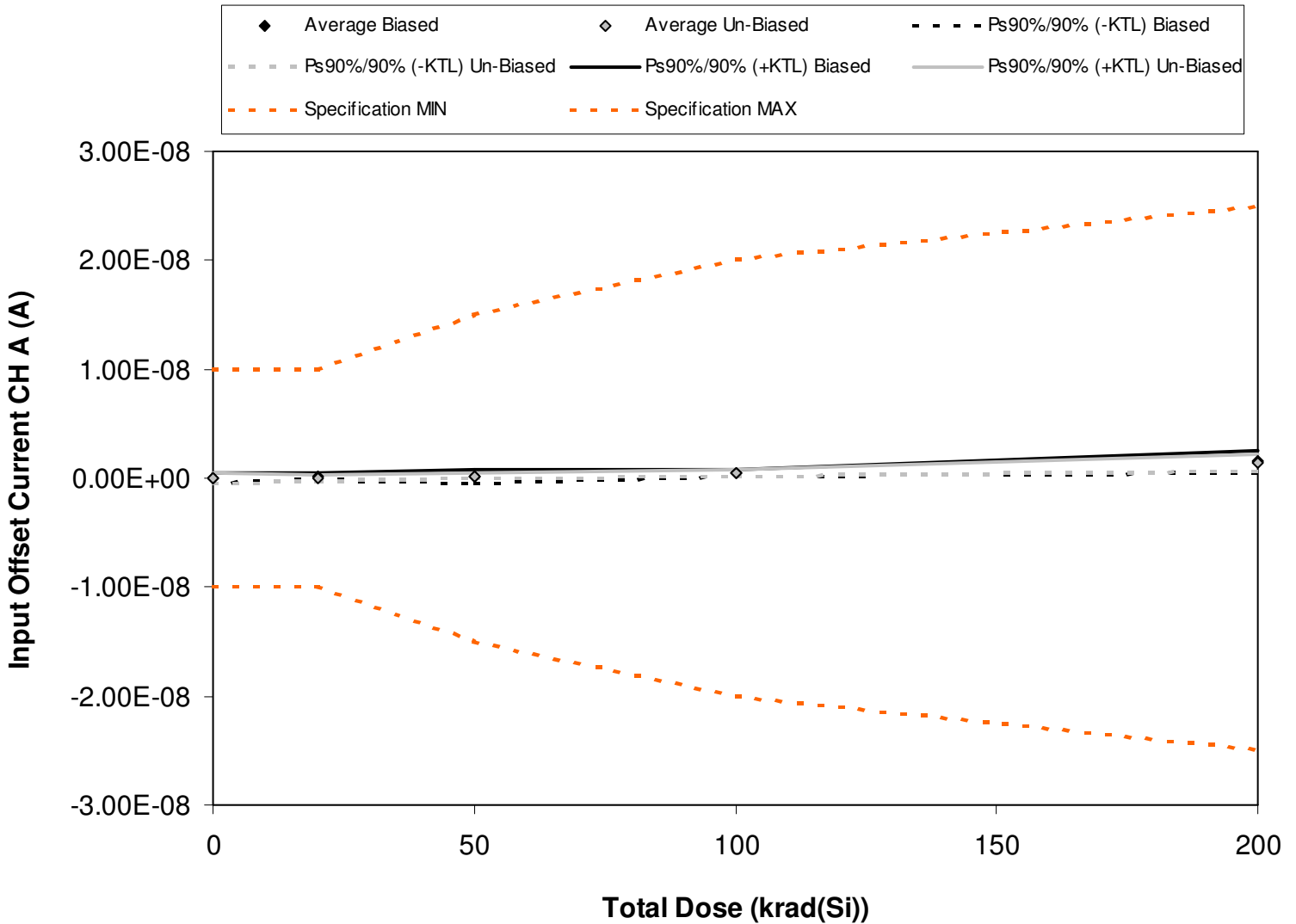

Figure 5.5. Plot of input offset current, channel A @ +/-15V (A) versus total dose. The data show no significant degradation with total dose, however the degradation is not sufficient to cause the KTL statistics to go out of specification. The solid diamonds are the average of measured data points from the biased sample (devices irradiated with an electrical bias) while the shaded diamonds are the average from the un-biased sample. The black lines show the effects on the data after application of the biased KTL statistics (solid and dashed lines) while the gray lines show the effects on the data after application of the unbiased KTL statistics (solid and dashed lines). The red dashed lines are the minimum and maximum specification values as defined in the datasheet and/or test plan.



Table 5.5. Raw data of input offset current, channel A @ +/-15V (A) versus total dose, including the statistical analysis, the specification and the status of the testing (pass/fail).

Input Offset Current CH A (A)	Total Dose (krad(Si))				
	0	20	50	100	200
Device					
1090	-2.09E-10	2.42E-10	3.13E-10	5.77E-10	1.33E-09
1092	1.62E-10	2.23E-10	-6.60E-11	3.66E-10	1.20E-09
1093	-7.10E-11	1.18E-10	-1.80E-11	5.73E-10	2.13E-09
1094	-9.20E-11	-2.10E-11	4.77E-10	4.86E-10	1.58E-09
1095	1.75E-10	2.61E-10	7.90E-11	4.19E-10	1.41E-09
1096	-6.00E-11	-1.18E-10	2.77E-10	4.97E-10	1.79E-09
1097	1.38E-10	1.84E-10	1.21E-10	5.06E-10	1.03E-09
1098	1.27E-10	2.90E-11	1.93E-10	2.09E-10	1.51E-09
1099	-3.06E-10	1.32E-10	2.74E-10	4.34E-10	1.66E-09
1100	-1.18E-10	-4.30E-11	1.35E-10	4.56E-10	1.27E-09
1106	-1.34E-10	9.30E-11	-2.13E-10	-1.80E-10	-1.32E-10
1113	-7.70E-11	-9.20E-11	3.20E-11	-5.60E-11	-1.13E-10
Biased Statistics					
Average Biased	-7.00E-12	1.65E-10	1.57E-10	4.84E-10	1.53E-09
Std Dev Biased	1.69E-10	1.18E-10	2.31E-10	9.32E-11	3.63E-10
Ps90%/90% (+KTL) Biased	4.56E-10	4.87E-10	7.90E-10	7.40E-10	2.52E-09
Ps90%/90% (-KTL) Biased	-4.70E-10	-1.58E-10	-4.76E-10	2.29E-10	5.34E-10
Un-Biased Statistics					
Average Un-Biased	-4.38E-11	3.68E-11	2.00E-10	4.20E-10	1.45E-09
Std Dev Un-Biased	1.85E-10	1.24E-10	7.40E-11	1.22E-10	3.05E-10
Ps90%/90% (+KTL) Un-Biased	4.63E-10	3.76E-10	4.03E-10	7.54E-10	2.29E-09
Ps90%/90% (-KTL) Un-Biased	-5.51E-10	-3.02E-10	-2.98E-12	8.64E-11	6.15E-10
Specification MIN	-1.00E-08	-1.00E-08	-1.50E-08	-2.00E-08	-2.50E-08
Status	PASS	PASS	PASS	PASS	PASS
Specification MAX	1.00E-08	1.00E-08	1.50E-08	2.00E-08	2.50E-08
Status	PASS	PASS	PASS	PASS	PASS

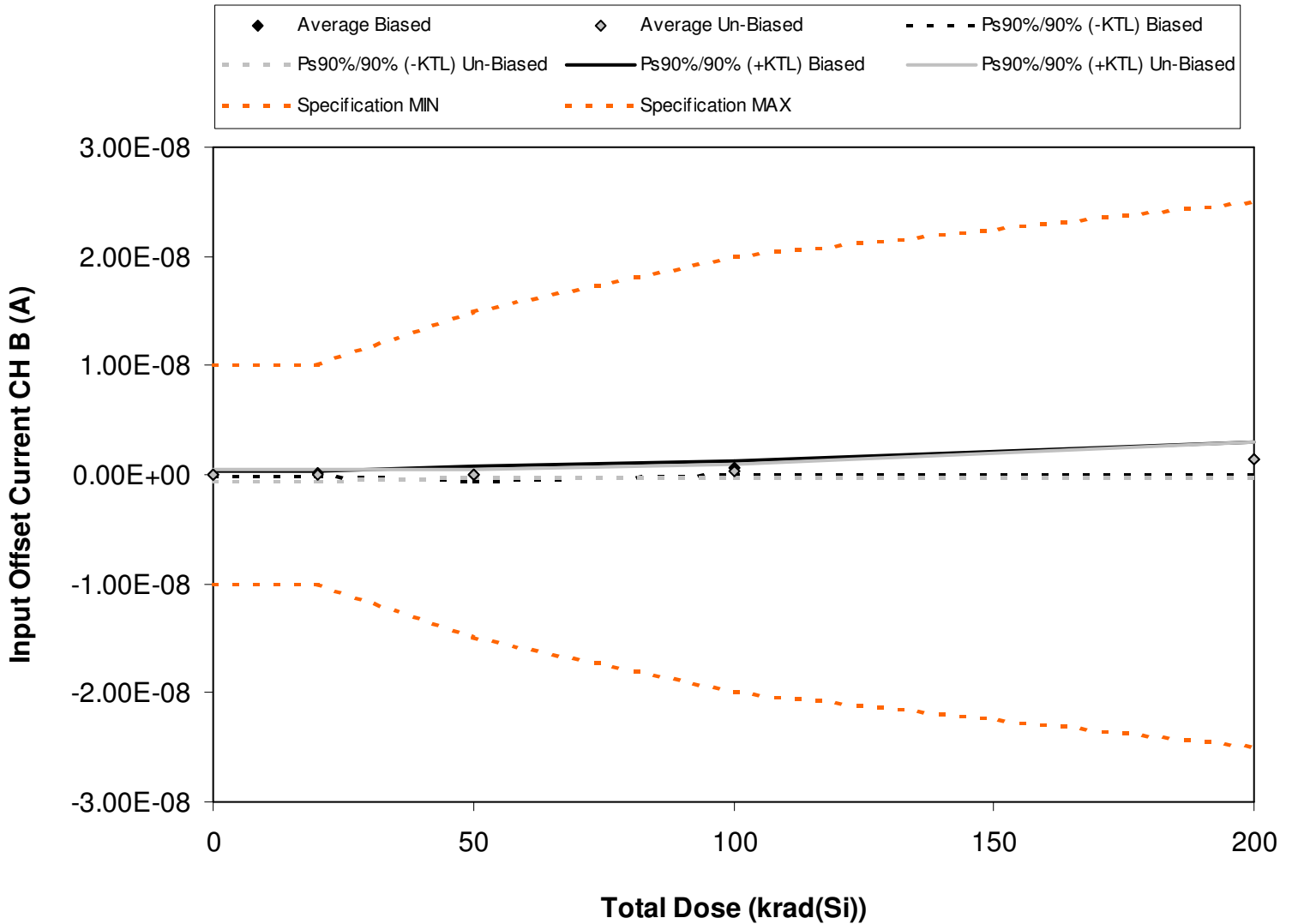

Figure 5.6. Plot of input offset current, channel B @ +/-15V (A) versus total dose. The data show no significant degradation with total dose, however the degradation is not sufficient to cause the KTL statistics to go out of specification. The solid diamonds are the average of measured data points from the biased sample (devices irradiated with an electrical bias) while the shaded diamonds are the average from the un-biased sample. The black lines show the effects on the data after application of the biased KTL statistics (solid and dashed lines) while the gray lines show the effects on the data after application of the unbiased KTL statistics (solid and dashed lines). The red dashed lines are the minimum and maximum specification values as defined in the datasheet and/or test plan.



Table 5.6. Raw data of input offset current, channel B @ +/-15V (A) versus total dose, including the statistical analysis, the specification and the status of the testing (pass/fail).

Input Offset Current CH B (A)	Total Dose (krad(Si))				
	0	20	50	100	200
Device					
1090	-5.50E-11	6.70E-11	-1.99E-10	5.56E-10	8.85E-10
1092	1.29E-10	-1.80E-11	-3.60E-11	3.58E-10	1.15E-09
1093	5.60E-11	9.20E-11	5.25E-10	8.73E-10	2.30E-09
1094	1.34E-10	2.46E-10	6.70E-11	7.98E-10	1.78E-09
1095	-3.40E-11	1.24E-10	-7.00E-11	3.83E-10	1.26E-09
1096	-2.56E-10	1.95E-10	2.34E-10	5.49E-10	2.17E-09
1097	2.20E-11	5.70E-11	-7.60E-11	4.15E-10	1.09E-09
1098	-2.36E-10	-2.66E-10	-2.10E-11	2.47E-10	1.50E-09
1099	-5.40E-11	1.22E-10	-2.40E-11	3.79E-10	1.67E-09
1100	2.22E-10	-1.90E-10	1.48E-10	1.20E-11	5.86E-10
1106	1.55E-10	4.60E-11	6.80E-11	8.50E-11	-1.79E-10
1113	-8.30E-11	-1.32E-10	2.23E-10	1.60E-10	9.50E-11
Biased Statistics					
Average Biased	4.60E-11	1.02E-10	5.74E-11	5.94E-10	1.48E-09
Std Dev Biased	8.85E-11	9.61E-11	2.78E-10	2.35E-10	5.64E-10
Ps90%/90% (+KTL) Biased	2.89E-10	3.66E-10	8.20E-10	1.24E-09	3.02E-09
Ps90%/90% (-KTL) Biased	-1.97E-10	-1.61E-10	-7.05E-10	-5.11E-11	-7.12E-11
Un-Biased Statistics					
Average Un-Biased	-6.04E-11	-1.64E-11	5.22E-11	3.20E-10	1.40E-09
Std Dev Un-Biased	1.97E-10	2.01E-10	1.32E-10	2.03E-10	5.98E-10
Ps90%/90% (+KTL) Un-Biased	4.81E-10	5.35E-10	4.14E-10	8.78E-10	3.04E-09
Ps90%/90% (-KTL) Un-Biased	-6.01E-10	-5.68E-10	-3.10E-10	-2.37E-10	-2.40E-10
Specification MIN	-1.00E-08	-1.00E-08	-1.50E-08	-2.00E-08	-2.50E-08
Status	PASS	PASS	PASS	PASS	PASS
Specification MAX	1.00E-08	1.00E-08	1.50E-08	2.00E-08	2.50E-08
Status	PASS	PASS	PASS	PASS	PASS

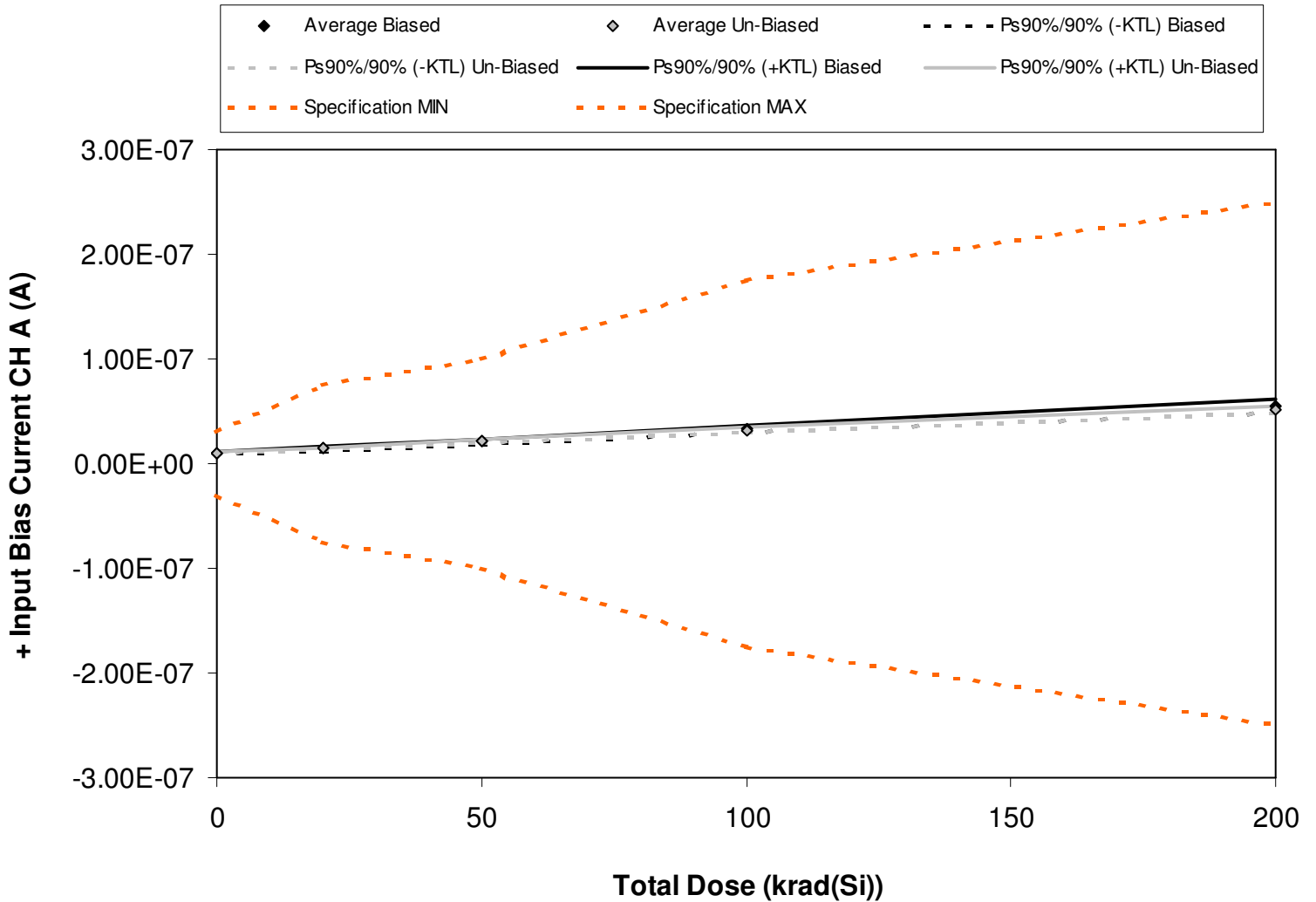

Figure 5.7. Plot of input bias current, non-inverting input @ +/-15V (A) for channel A versus total dose. The data show only a slight increase with total dose. The solid diamonds are the average of measured data points from the biased sample (devices irradiated with an electrical bias) while the shaded diamonds are the average from the un-biased sample. The black lines show the effects on the data after application of the biased KTL statistics (solid and dashed lines) while the gray lines show the effects on the data after application of the unbiased KTL statistics (solid and dashed lines). The red dashed lines are the minimum and maximum specification values as defined in the datasheet and/or test plan.



Table 5.7. Raw data of the input bias current, non-inverting input @ +/-15V (A) for channel A versus total dose, including the statistical analysis, the specification and the status of the testing (pass/fail).

+ Input Bias Current CH A (A)	Total Dose (krad(Si))				
	0	20	50	100	200
Device					
1090	1.04E-08	1.40E-08	2.15E-08	3.33E-08	5.53E-08
1092	1.04E-08	1.40E-08	2.14E-08	3.32E-08	5.57E-08
1093	9.95E-09	1.34E-08	2.02E-08	3.11E-08	5.09E-08
1094	1.13E-08	1.50E-08	2.26E-08	3.49E-08	5.75E-08
1095	1.09E-08	1.46E-08	2.20E-08	3.39E-08	5.62E-08
1096	1.06E-08	1.39E-08	2.02E-08	3.07E-08	4.99E-08
1097	1.12E-08	1.47E-08	2.14E-08	3.23E-08	5.25E-08
1098	1.09E-08	1.46E-08	2.13E-08	3.26E-08	5.18E-08
1099	1.11E-08	1.45E-08	2.14E-08	3.26E-08	5.22E-08
1100	1.03E-08	1.37E-08	2.04E-08	3.15E-08	5.13E-08
1106	1.06E-08	1.06E-08	1.07E-08	1.06E-08	1.07E-08
1113	1.09E-08	1.09E-08	1.09E-08	1.09E-08	1.09E-08
Biased Statistics					
Average Biased	1.06E-08	1.42E-08	2.15E-08	3.33E-08	5.51E-08
Std Dev Biased	5.13E-10	6.29E-10	9.07E-10	1.43E-09	2.51E-09
Ps90%/90% (+KTL) Biased	1.20E-08	1.59E-08	2.40E-08	3.72E-08	6.20E-08
Ps90%/90% (-KTL) Biased	9.19E-09	1.25E-08	1.90E-08	2.94E-08	4.82E-08
Un-Biased Statistics					
Average Un-Biased	1.08E-08	1.43E-08	2.09E-08	3.19E-08	5.15E-08
Std Dev Un-Biased	3.71E-10	4.34E-10	5.81E-10	8.40E-10	1.03E-09
Ps90%/90% (+KTL) Un-Biased	1.18E-08	1.55E-08	2.25E-08	3.42E-08	5.43E-08
Ps90%/90% (-KTL) Un-Biased	9.80E-09	1.31E-08	1.93E-08	2.96E-08	4.87E-08
Specification MIN	-3.00E-08	-7.50E-08	-1.00E-07	-1.75E-07	-2.50E-07
Status	PASS	PASS	PASS	PASS	PASS
Specification MAX	3.00E-08	7.50E-08	1.00E-07	1.75E-07	2.50E-07
Status	PASS	PASS	PASS	PASS	PASS

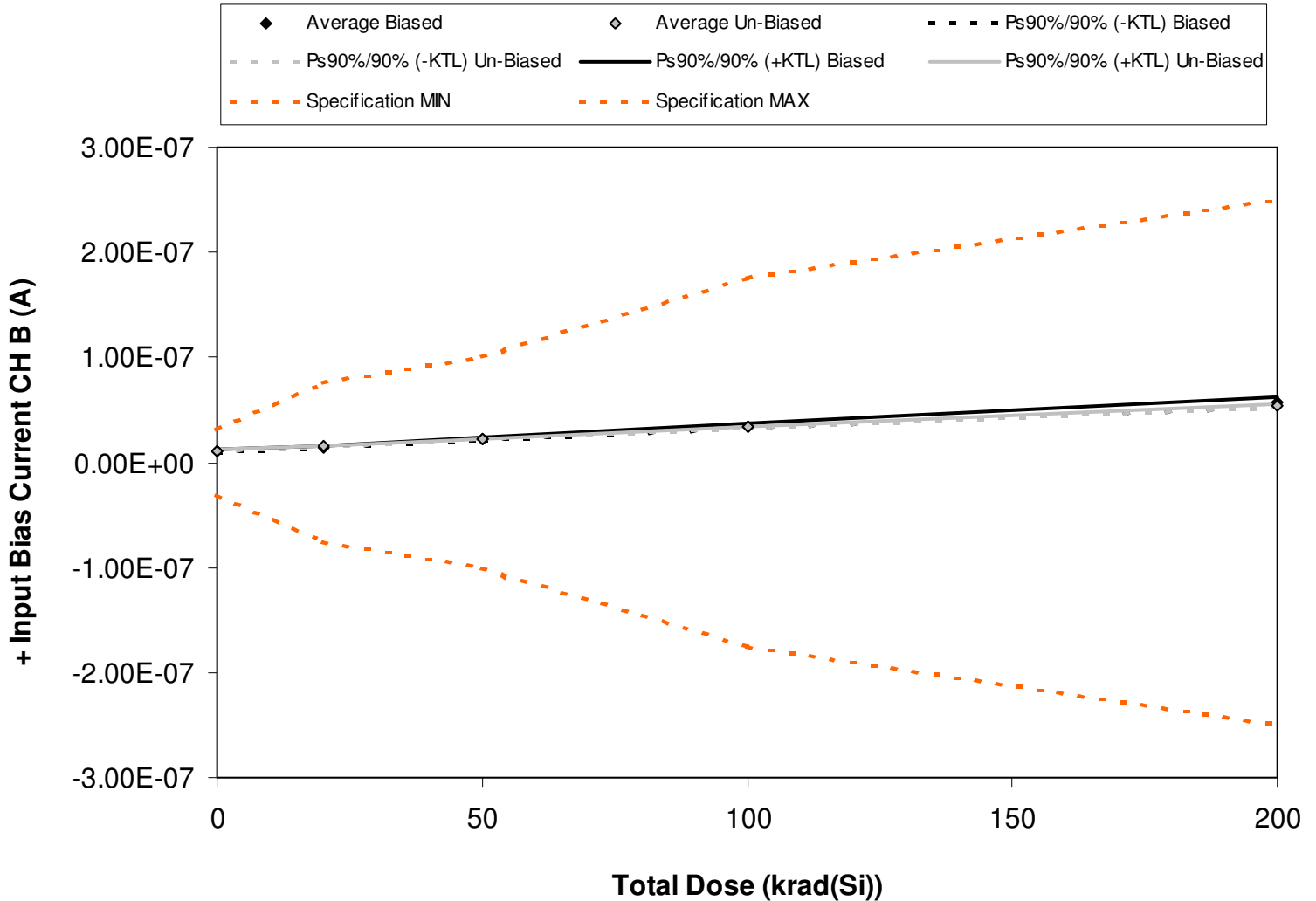

Figure 5.8. Plot of input bias current, non-inverting input @ +/-15V (A) for channel B versus total dose. The data show only a slight increase with total dose. The solid diamonds are the average of measured data points from the biased sample (devices irradiated with an electrical bias) while the shaded diamonds are the average from the un-biased sample. The black lines show the effects on the data after application of the biased KTL statistics (solid and dashed lines) while the gray lines show the effects on the data after application of the unbiased KTL statistics (solid and dashed lines). The red dashed lines are the minimum and maximum specification values as defined in the datasheet and/or test plan.



Table 5.8. Raw data of the input bias current, non-inverting input @ +/-15V (A) for channel B versus total dose, including the statistical analysis, the specification and the status of the testing (pass/fail).

+ Input Bias Current CH B (A)	Total Dose (krad(Si))				
	0	20	50	100	200
Device					
1090	1.08E-08	1.45E-08	2.21E-08	3.41E-08	5.65E-08
1092	1.08E-08	1.45E-08	2.21E-08	3.45E-08	5.77E-08
1093	1.08E-08	1.44E-08	2.17E-08	3.33E-08	5.46E-08
1094	1.18E-08	1.56E-08	2.35E-08	3.61E-08	5.94E-08
1095	1.14E-08	1.52E-08	2.29E-08	3.54E-08	5.83E-08
1096	1.15E-08	1.51E-08	2.20E-08	3.32E-08	5.36E-08
1097	1.17E-08	1.54E-08	2.21E-08	3.34E-08	5.42E-08
1098	1.12E-08	1.50E-08	2.20E-08	3.36E-08	5.33E-08
1099	1.15E-08	1.51E-08	2.21E-08	3.39E-08	5.41E-08
1100	1.13E-08	1.49E-08	2.22E-08	3.39E-08	5.52E-08
1106	1.11E-08	1.10E-08	1.10E-08	1.10E-08	1.10E-08
1113	1.07E-08	1.07E-08	1.08E-08	1.07E-08	1.07E-08
Biased Statistics					
Average Biased	1.11E-08	1.48E-08	2.25E-08	3.47E-08	5.73E-08
Std Dev Biased	4.56E-10	5.44E-10	7.11E-10	1.08E-09	1.84E-09
Ps90%/90% (+KTL) Biased	1.24E-08	1.63E-08	2.44E-08	3.76E-08	6.23E-08
Ps90%/90% (-KTL) Biased	9.85E-09	1.34E-08	2.05E-08	3.17E-08	5.23E-08
Un-Biased Statistics					
Average Un-Biased	1.14E-08	1.51E-08	2.21E-08	3.36E-08	5.41E-08
Std Dev Un-Biased	2.22E-10	1.84E-10	9.69E-11	2.93E-10	7.25E-10
Ps90%/90% (+KTL) Un-Biased	1.20E-08	1.56E-08	2.23E-08	3.44E-08	5.61E-08
Ps90%/90% (-KTL) Un-Biased	1.08E-08	1.46E-08	2.18E-08	3.28E-08	5.21E-08
Specification MIN	-3.00E-08	-7.50E-08	-1.00E-07	-1.75E-07	-2.50E-07
Status	PASS	PASS	PASS	PASS	PASS
Specification MAX	3.00E-08	7.50E-08	1.00E-07	1.75E-07	2.50E-07
Status	PASS	PASS	PASS	PASS	PASS

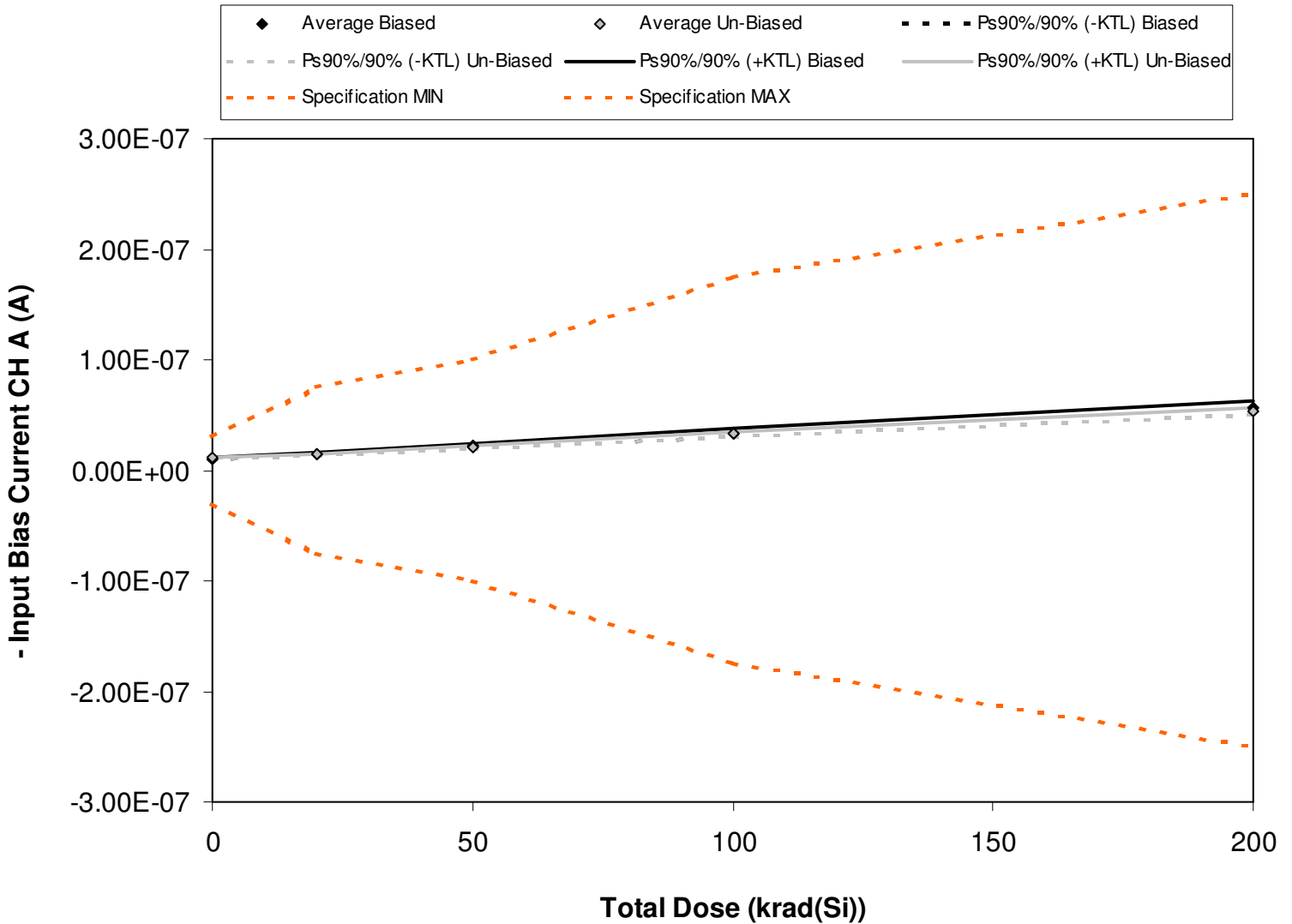

Figure 5.9. Plot of input bias current, inverting input @ +/-15V for channel A versus total dose. The data show only a slight increase with total dose. The solid diamonds are the average of measured data points from the biased sample (devices irradiated with an electrical bias) while the shaded diamonds are the average from the un-biased sample. The black lines show the effects on the data after application of the biased KTL statistics (solid and dashed lines) while the gray lines show the effects on the data after application of the unbiased KTL statistics (solid and dashed lines). The red dashed lines are the minimum and maximum specification values as defined in the datasheet and/or test plan.



Table 5.9. Raw data for the input bias current, inverting input @ +/-15V for channel A versus total dose, including the statistical analysis, the specification and the status of the testing (pass/fail).

- Input Bias Current CH A (A)	Total Dose (krad(Si))				
	0	20	50	100	200
Device					
1090	1.04E-08	1.41E-08	2.19E-08	3.39E-08	5.67E-08
1092	1.05E-08	1.41E-08	2.15E-08	3.38E-08	5.71E-08
1093	1.01E-08	1.36E-08	2.04E-08	3.19E-08	5.31E-08
1094	1.13E-08	1.50E-08	2.31E-08	3.57E-08	5.97E-08
1095	1.11E-08	1.46E-08	2.23E-08	3.48E-08	5.77E-08
1096	1.08E-08	1.39E-08	2.05E-08	3.14E-08	5.18E-08
1097	1.13E-08	1.48E-08	2.17E-08	3.27E-08	5.38E-08
1098	1.11E-08	1.47E-08	2.15E-08	3.32E-08	5.37E-08
1099	1.10E-08	1.45E-08	2.16E-08	3.34E-08	5.43E-08
1100	1.04E-08	1.40E-08	2.05E-08	3.22E-08	5.27E-08
1106	1.05E-08	1.05E-08	1.05E-08	1.04E-08	1.06E-08
1113	1.10E-08	1.11E-08	1.09E-08	1.08E-08	1.09E-08
Biased Statistics					
Average Biased	1.07E-08	1.43E-08	2.18E-08	3.40E-08	5.69E-08
Std Dev Biased	4.99E-10	5.29E-10	1.01E-09	1.43E-09	2.41E-09
Ps90%/90% (+KTL) Biased	1.21E-08	1.57E-08	2.46E-08	3.79E-08	6.35E-08
Ps90%/90% (-KTL) Biased	9.32E-09	1.28E-08	1.91E-08	3.01E-08	5.03E-08
Un-Biased Statistics					
Average Un-Biased	1.09E-08	1.44E-08	2.12E-08	3.26E-08	5.33E-08
Std Dev Un-Biased	3.62E-10	3.86E-10	6.00E-10	8.05E-10	1.01E-09
Ps90%/90% (+KTL) Un-Biased	1.19E-08	1.54E-08	2.28E-08	3.48E-08	5.60E-08
Ps90%/90% (-KTL) Un-Biased	9.91E-09	1.33E-08	1.95E-08	3.04E-08	5.05E-08
Specification MIN	-3.00E-08	-7.50E-08	-1.00E-07	-1.75E-07	-2.50E-07
Status	PASS	PASS	PASS	PASS	PASS
Specification MAX	3.00E-08	7.50E-08	1.00E-07	1.75E-07	2.50E-07
Status	PASS	PASS	PASS	PASS	PASS

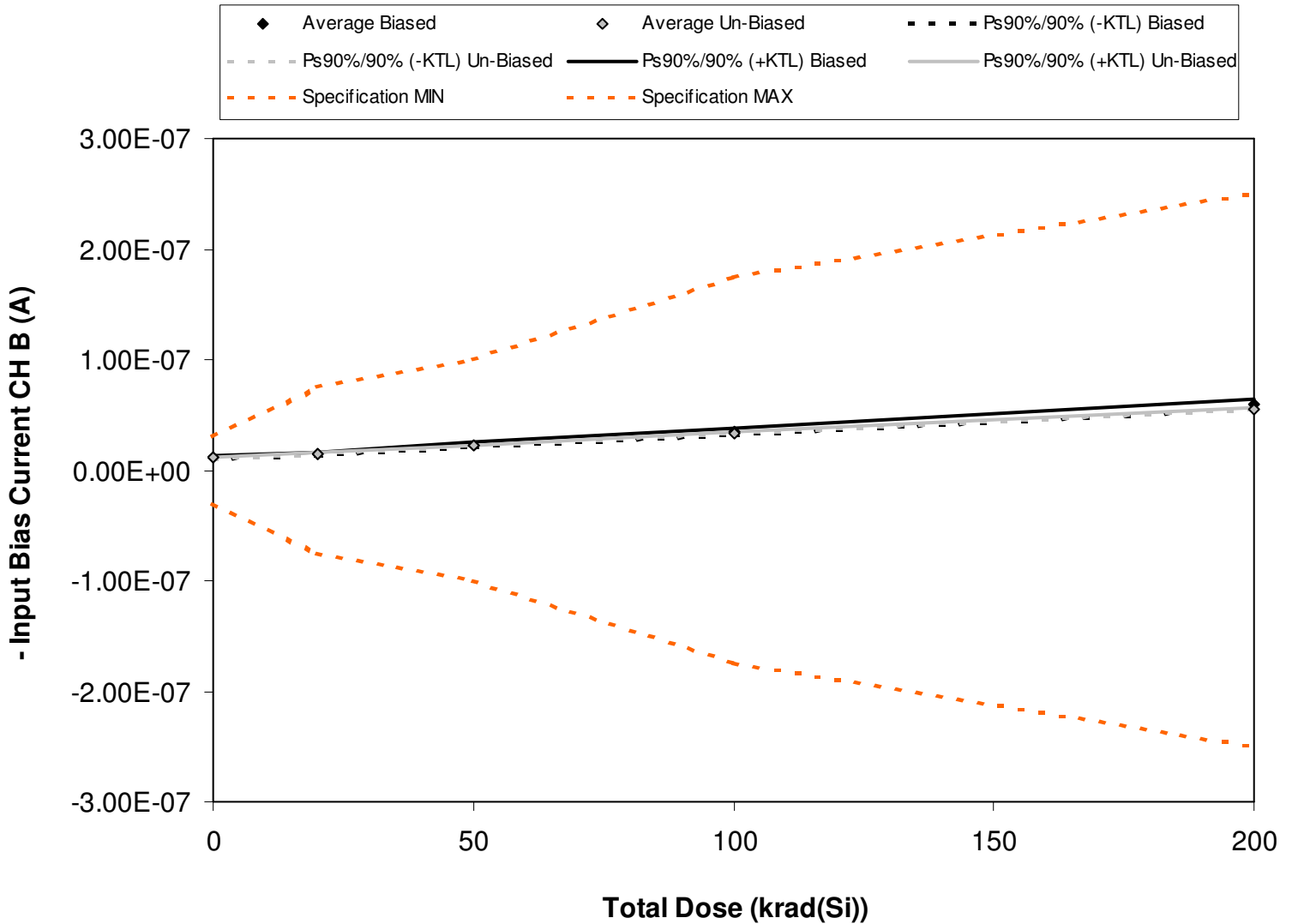

Figure 5.10. Plot of input bias current, inverting input @ +/-15V for channel B versus total dose. The data show only a slight increase with total dose. The solid diamonds are the average of measured data points from the biased sample (devices irradiated with an electrical bias) while the shaded diamonds are the average from the un-biased sample. The black lines show the effects on the data after application of the biased KTL statistics (solid and dashed lines) while the gray lines show the effects on the data after application of the unbiased KTL statistics (solid and dashed lines). The red dashed lines are the minimum and maximum specification values as defined in the datasheet and/or test plan.



Table 5.10. Raw data for the input bias current, inverting input @ +/-15V for channel B versus total dose, including the statistical analysis, the specification and the status of the testing (pass/fail).

- Input Bias Current CH B (A)	Total Dose (krad(Si))				
	0	20	50	100	200
Device					
1090	1.07E-08	1.46E-08	2.21E-08	3.45E-08	5.79E-08
1092	1.10E-08	1.47E-08	2.20E-08	3.47E-08	5.90E-08
1093	1.08E-08	1.47E-08	2.22E-08	3.46E-08	5.73E-08
1094	1.20E-08	1.59E-08	2.39E-08	3.69E-08	6.14E-08
1095	1.14E-08	1.55E-08	2.30E-08	3.61E-08	6.00E-08
1096	1.14E-08	1.50E-08	2.24E-08	3.36E-08	5.58E-08
1097	1.17E-08	1.53E-08	2.21E-08	3.40E-08	5.56E-08
1098	1.11E-08	1.51E-08	2.21E-08	3.38E-08	5.50E-08
1099	1.13E-08	1.52E-08	2.24E-08	3.42E-08	5.58E-08
1100	1.15E-08	1.49E-08	2.22E-08	3.41E-08	5.59E-08
1106	1.12E-08	1.12E-08	1.09E-08	1.10E-08	1.09E-08
1113	1.06E-08	1.06E-08	1.07E-08	1.07E-08	1.06E-08
Biased Statistics					
Average Biased	1.12E-08	1.51E-08	2.27E-08	3.54E-08	5.91E-08
Std Dev Biased	5.46E-10	5.81E-10	7.90E-10	1.07E-09	1.64E-09
Ps90%/90% (+KTL) Biased	1.27E-08	1.67E-08	2.48E-08	3.83E-08	6.36E-08
Ps90%/90% (-KTL) Biased	9.69E-09	1.35E-08	2.05E-08	3.24E-08	5.46E-08
Un-Biased Statistics					
Average Un-Biased	1.14E-08	1.51E-08	2.23E-08	3.40E-08	5.56E-08
Std Dev Un-Biased	2.42E-10	1.74E-10	1.50E-10	2.50E-10	3.79E-10
Ps90%/90% (+KTL) Un-Biased	1.21E-08	1.56E-08	2.27E-08	3.46E-08	5.67E-08
Ps90%/90% (-KTL) Un-Biased	1.08E-08	1.46E-08	2.18E-08	3.33E-08	5.46E-08
Specification MIN	-3.00E-08	-7.50E-08	-1.00E-07	-1.75E-07	-2.50E-07
Status	PASS	PASS	PASS	PASS	PASS
Specification MAX	3.00E-08	7.50E-08	1.00E-07	1.75E-07	2.50E-07
Status	PASS	PASS	PASS	PASS	PASS

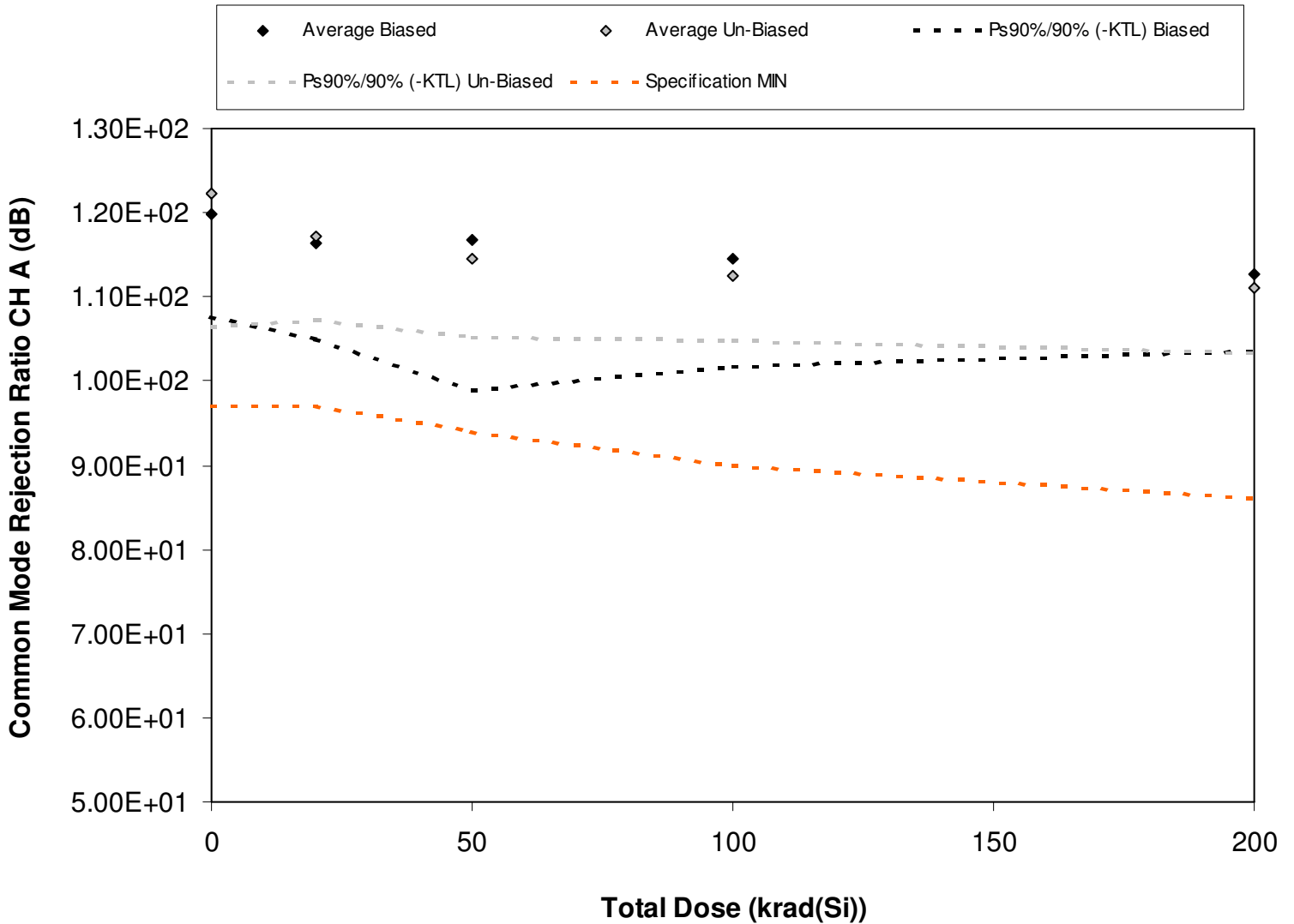

Figure 5.11. Plot of common mode rejection ratio for channel A versus total dose. Although the data show a decrease with total dose, it is not sufficient to fall below the specification value. The solid diamonds are the average of measured data points from the biased sample (devices irradiated with an electrical bias) while the shaded diamonds are the average from the un-biased sample. The black lines show the effects on the data after application of the biased KTL statistics (solid and/or dashed lines) while the gray lines show the effects on the data after application of the unbiased KTL statistics (solid and/or dashed lines). The red dashed lines are the minimum and/or maximum specification values as defined in the datasheet and/or test plan.



Table 5.11. Raw data of the common mode rejection ratio for channel A versus total dose, including the statistical analysis, the specification and the status of the testing (pass/fail).

Common Mode Rejection Ratio CH A (dB)	Total Dose (krad(Si))				
	0	20	50	100	200
Device					
1090	1.26E+02	1.23E+02	1.28E+02	1.22E+02	1.18E+02
1092	1.20E+02	1.17E+02	1.16E+02	1.14E+02	1.13E+02
1093	1.18E+02	1.15E+02	1.14E+02	1.12E+02	1.11E+02
1094	1.14E+02	1.12E+02	1.10E+02	1.09E+02	1.08E+02
1095	1.22E+02	1.16E+02	1.16E+02	1.14E+02	1.13E+02
1096	1.24E+02	1.19E+02	1.15E+02	1.14E+02	1.11E+02
1097	1.22E+02	1.18E+02	1.16E+02	1.13E+02	1.12E+02
1098	1.29E+02	1.20E+02	1.18E+02	1.16E+02	1.15E+02
1099	1.23E+02	1.17E+02	1.14E+02	1.12E+02	1.11E+02
1100	1.13E+02	1.11E+02	1.09E+02	1.08E+02	1.07E+02
1106	1.23E+02	1.23E+02	1.28E+02	1.23E+02	1.23E+02
1113	1.16E+02	1.16E+02	1.17E+02	1.16E+02	1.18E+02
Biased Statistics					
Average Biased	1.20E+02	1.16E+02	1.17E+02	1.14E+02	1.13E+02
Std Dev Biased	4.48E+00	4.16E+00	6.52E+00	4.66E+00	3.37E+00
Ps90%/90% (+KTL) Biased	1.32E+02	1.28E+02	1.35E+02	1.27E+02	1.22E+02
Ps90%/90% (-KTL) Biased	1.08E+02	1.05E+02	9.89E+01	1.02E+02	1.04E+02
Un-Biased Statistics					
Average Un-Biased	1.22E+02	1.17E+02	1.14E+02	1.13E+02	1.11E+02
Std Dev Un-Biased	5.83E+00	3.63E+00	3.38E+00	2.81E+00	2.84E+00
Ps90%/90% (+KTL) Un-Biased	1.38E+02	1.27E+02	1.24E+02	1.20E+02	1.19E+02
Ps90%/90% (-KTL) Un-Biased	1.06E+02	1.07E+02	1.05E+02	1.05E+02	1.03E+02
Specification MIN	9.70E+01	9.70E+01	9.40E+01	9.00E+01	8.60E+01
Status	PASS	PASS	PASS	PASS	PASS

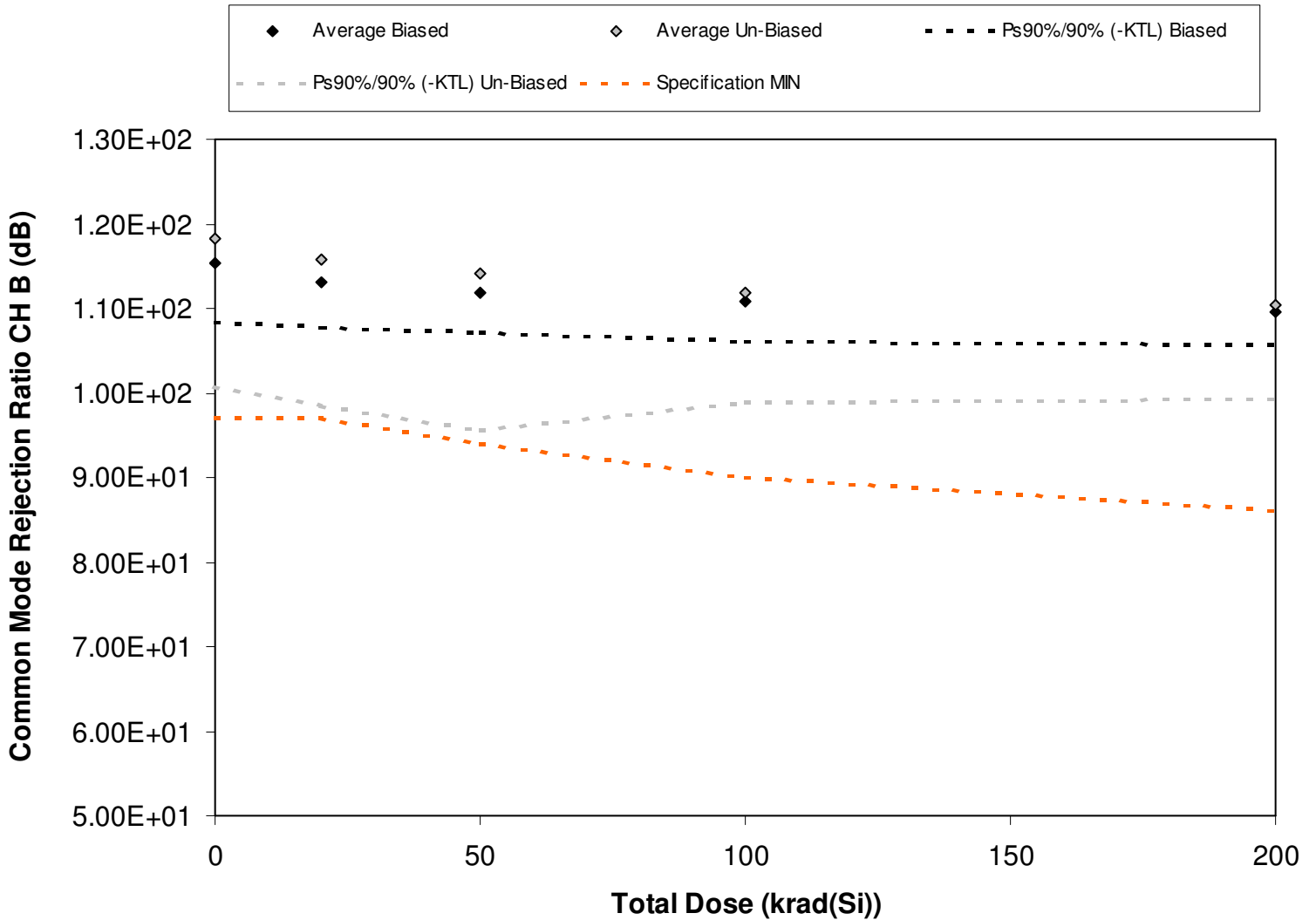

Figure 5.12. Plot of common mode rejection ratio for channel B versus total dose. Although the data show a decrease with total dose, it is not sufficient to fall below the specification value. The solid diamonds are the average of measured data points from the biased sample (devices irradiated with an electrical bias) while the shaded diamonds are the average from the un-biased sample. The black lines show the effects on the data after application of the biased KTL statistics (solid and/or dashed lines) while the gray lines show the effects on the data after application of the unbiased KTL statistics (solid and/or dashed lines). The red dashed lines are the minimum and/or maximum specification values as defined in the datasheet and/or test plan.



Table 5.12. Raw data of the common mode rejection ratio for channel B versus total dose, including the statistical analysis, the specification and the status of the testing (pass/fail).

Common Mode Rejection Ratio CH B (dB)	Total Dose (krad(Si))				
	0	20	50	100	200
Device					
1090	1.18E+02	1.15E+02	1.13E+02	1.12E+02	1.11E+02
1092	1.12E+02	1.11E+02	1.10E+02	1.09E+02	1.08E+02
1093	1.17E+02	1.14E+02	1.13E+02	1.12E+02	1.11E+02
1094	1.13E+02	1.11E+02	1.10E+02	1.09E+02	1.08E+02
1095	1.17E+02	1.15E+02	1.13E+02	1.12E+02	1.11E+02
1096	1.17E+02	1.14E+02	1.12E+02	1.11E+02	1.09E+02
1097	1.15E+02	1.13E+02	1.11E+02	1.10E+02	1.09E+02
1098	1.30E+02	1.27E+02	1.26E+02	1.20E+02	1.18E+02
1099	1.15E+02	1.13E+02	1.11E+02	1.10E+02	1.08E+02
1100	1.14E+02	1.12E+02	1.10E+02	1.09E+02	1.08E+02
1106	1.11E+02	1.12E+02	1.12E+02	1.12E+02	1.11E+02
1113	1.15E+02	1.15E+02	1.15E+02	1.15E+02	1.15E+02
Biased Statistics					
Average Biased	1.15E+02	1.13E+02	1.12E+02	1.11E+02	1.10E+02
Std Dev Biased	2.56E+00	2.02E+00	1.75E+00	1.70E+00	1.49E+00
Ps90%/90% (+KTL) Biased	1.22E+02	1.19E+02	1.17E+02	1.15E+02	1.14E+02
Ps90%/90% (-KTL) Biased	1.08E+02	1.08E+02	1.07E+02	1.06E+02	1.06E+02
Un-Biased Statistics					
Average Un-Biased	1.18E+02	1.16E+02	1.14E+02	1.12E+02	1.10E+02
Std Dev Un-Biased	6.37E+00	6.31E+00	6.77E+00	4.69E+00	4.04E+00
Ps90%/90% (+KTL) Un-Biased	1.36E+02	1.33E+02	1.33E+02	1.25E+02	1.21E+02
Ps90%/90% (-KTL) Un-Biased	1.01E+02	9.86E+01	9.57E+01	9.89E+01	9.93E+01
Specification MIN	9.70E+01	9.70E+01	9.40E+01	9.00E+01	8.60E+01
Status	PASS	PASS	PASS	PASS	PASS

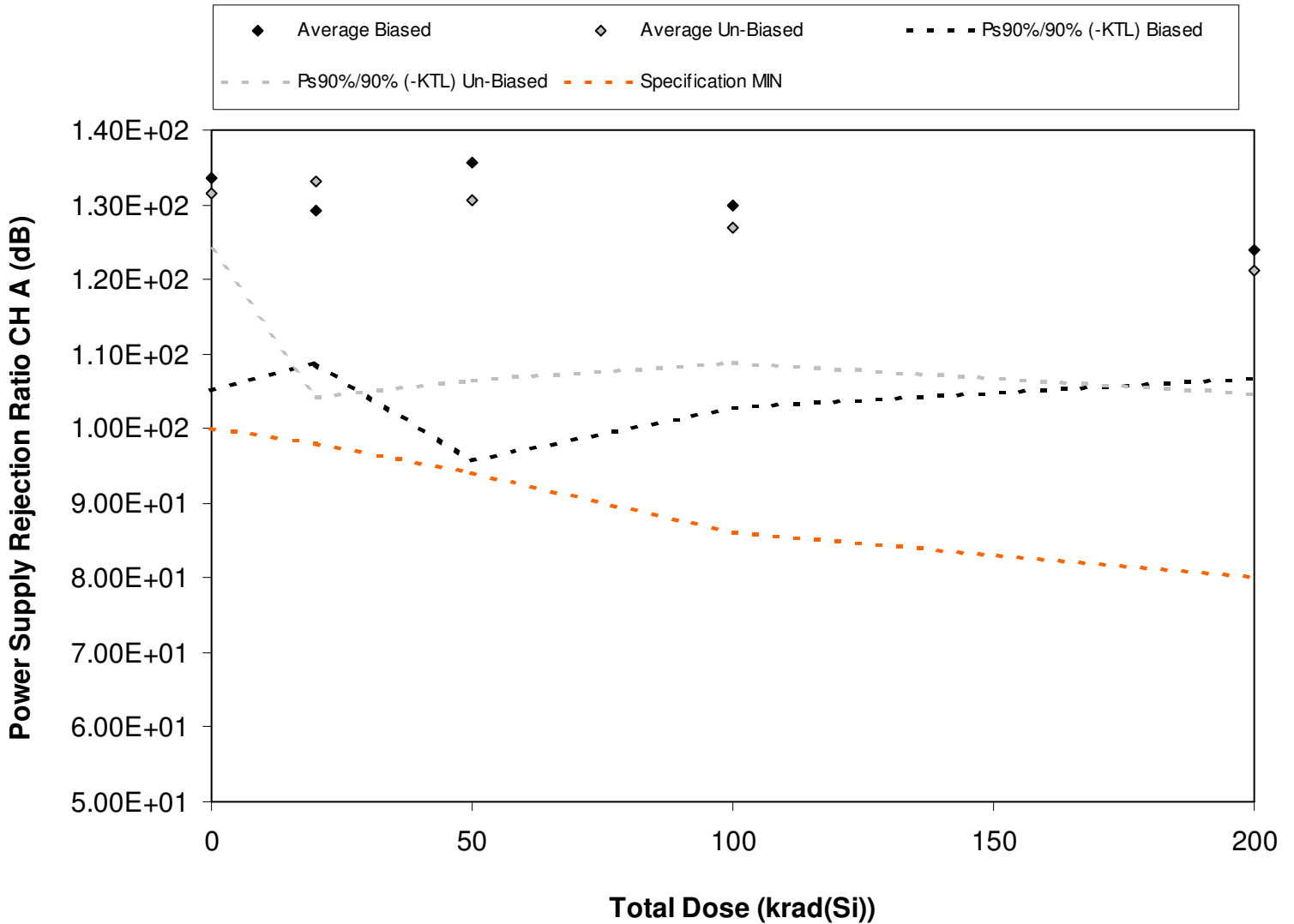

Figure 5.13. Plot of power supply rejection ratio for channel A versus total dose. Although the data show a decrease with total dose, it is not sufficient to fall below the specification value. The solid diamonds are the average of measured data points from the biased sample (devices irradiated with an electrical bias) while the shaded diamonds are the average from the un-biased sample. The black lines show the effects on the data after application of the biased KTL statistics (solid and/or dashed lines) while the gray lines show the effects on the data after application of the unbiased KTL statistics (solid and/or dashed lines). The red dashed lines are the minimum and/or maximum specification values as defined in the datasheet and/or test plan.



Table 5.13. Raw data of the power supply rejection ratio for channel A versus total dose, including the statistical analysis, the specification and the status of the testing (pass/fail).

Power Supply Rejection Ratio CH A (dB)	Total Dose (krad(Si))				
	0	20	50	100	200
Device					
1090	1.35E+02	1.34E+02	1.26E+02	1.38E+02	1.26E+02
1092	1.31E+02	1.35E+02	1.49E+02	1.25E+02	1.26E+02
1093	1.33E+02	1.29E+02	1.49E+02	1.41E+02	1.31E+02
1094	1.20E+02	1.17E+02	1.16E+02	1.16E+02	1.14E+02
1095	1.49E+02	1.32E+02	1.38E+02	1.29E+02	1.23E+02
1096	1.36E+02	1.45E+02	1.32E+02	1.32E+02	1.25E+02
1097	1.31E+02	1.44E+02	1.42E+02	1.33E+02	1.22E+02
1098	1.31E+02	1.25E+02	1.35E+02	1.30E+02	1.29E+02
1099	1.28E+02	1.29E+02	1.24E+02	1.19E+02	1.16E+02
1100	1.31E+02	1.23E+02	1.20E+02	1.20E+02	1.14E+02
1106	1.25E+02	1.27E+02	1.30E+02	1.26E+02	1.30E+02
1113	1.32E+02	1.58E+02	1.37E+02	1.36E+02	1.37E+02
Biased Statistics					
Average Biased	1.34E+02	1.29E+02	1.36E+02	1.30E+02	1.24E+02
Std Dev Biased	1.04E+01	7.40E+00	1.45E+01	9.90E+00	6.34E+00
Ps90%/90% (+KTL) Biased	1.62E+02	1.49E+02	1.75E+02	1.57E+02	1.41E+02
Ps90%/90% (-KTL) Biased	1.05E+02	1.09E+02	9.57E+01	1.03E+02	1.07E+02
Un-Biased Statistics					
Average Un-Biased	1.32E+02	1.33E+02	1.31E+02	1.27E+02	1.21E+02
Std Dev Un-Biased	2.83E+00	1.05E+01	8.79E+00	6.65E+00	6.08E+00
Ps90%/90% (+KTL) Un-Biased	1.39E+02	1.62E+02	1.55E+02	1.45E+02	1.38E+02
Ps90%/90% (-KTL) Un-Biased	1.24E+02	1.04E+02	1.06E+02	1.09E+02	1.05E+02
Specification MIN	1.00E+02	9.80E+01	9.40E+01	8.60E+01	8.00E+01
Status	PASS	PASS	PASS	PASS	PASS

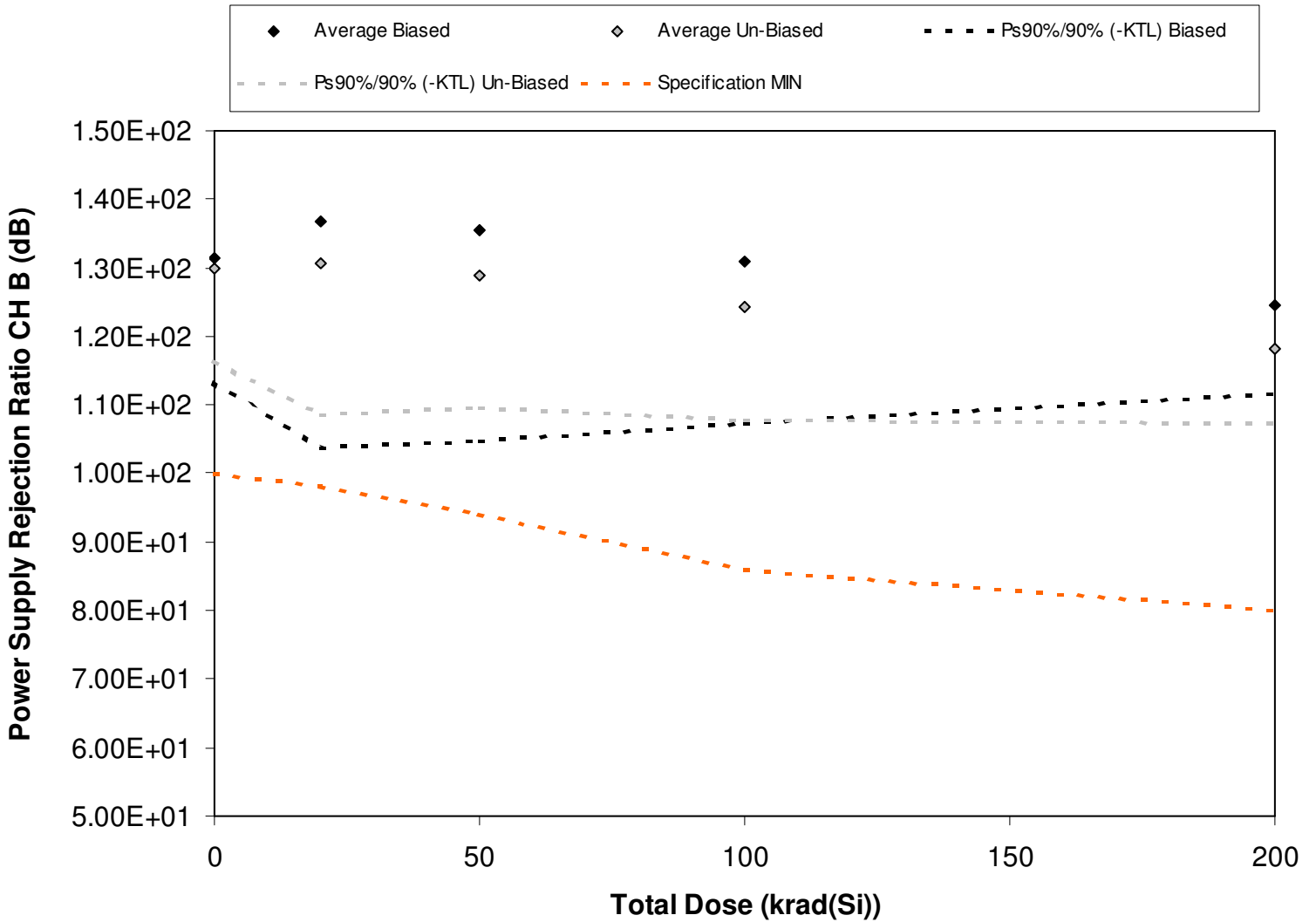

Figure 5.14. Plot of power supply rejection ratio for channel B versus total dose. Although the data show a decrease with total dose, it is not sufficient to fall below the specification value. The solid diamonds are the average of measured data points from the biased sample (devices irradiated with an electrical bias) while the shaded diamonds are the average from the un-biased sample. The black lines show the effects on the data after application of the biased KTL statistics (solid and/or dashed lines) while the gray lines show the effects on the data after application of the unbiased KTL statistics (solid and/or dashed lines). The red dashed lines are the minimum and/or maximum specification values as defined in the datasheet and/or test plan.



Table 5.14. Raw data of the power supply rejection ratio for channel B versus total dose, including the statistical analysis, the specification and the status of the testing (pass/fail).

Power Supply Rejection Ratio CH B (dB)	Total Dose (krad(Si))				
	0	20	50	100	200
Device					
1090	1.40E+02	1.47E+02	1.45E+02	1.32E+02	1.22E+02
1092	1.31E+02	1.41E+02	1.39E+02	1.34E+02	1.30E+02
1093	1.22E+02	1.21E+02	1.24E+02	1.23E+02	1.28E+02
1094	1.32E+02	1.27E+02	1.23E+02	1.22E+02	1.18E+02
1095	1.32E+02	1.48E+02	1.47E+02	1.43E+02	1.25E+02
1096	1.36E+02	1.36E+02	1.30E+02	1.22E+02	1.18E+02
1097	1.32E+02	1.27E+02	1.23E+02	1.21E+02	1.17E+02
1098	1.29E+02	1.25E+02	1.33E+02	1.30E+02	1.24E+02
1099	1.23E+02	1.22E+02	1.20E+02	1.17E+02	1.13E+02
1100	1.29E+02	1.42E+02	1.37E+02	1.31E+02	1.18E+02
1106	1.30E+02	1.29E+02	1.27E+02	1.31E+02	1.28E+02
1113	1.28E+02	1.25E+02	1.29E+02	1.28E+02	1.30E+02
Biased Statistics					
Average Biased	1.31E+02	1.37E+02	1.36E+02	1.31E+02	1.25E+02
Std Dev Biased	6.59E+00	1.21E+01	1.13E+01	8.56E+00	4.78E+00
Ps90%/90% (+KTL) Biased	1.50E+02	1.70E+02	1.67E+02	1.54E+02	1.38E+02
Ps90%/90% (-KTL) Biased	1.13E+02	1.04E+02	1.05E+02	1.07E+02	1.12E+02
Un-Biased Statistics					
Average Un-Biased	1.30E+02	1.31E+02	1.29E+02	1.24E+02	1.18E+02
Std Dev Un-Biased	4.95E+00	8.00E+00	7.01E+00	6.04E+00	3.96E+00
Ps90%/90% (+KTL) Un-Biased	1.43E+02	1.52E+02	1.48E+02	1.41E+02	1.29E+02
Ps90%/90% (-KTL) Un-Biased	1.16E+02	1.09E+02	1.10E+02	1.08E+02	1.07E+02
Specification MIN	1.00E+02	9.80E+01	9.40E+01	8.60E+01	8.00E+01
Status	PASS	PASS	PASS	PASS	PASS

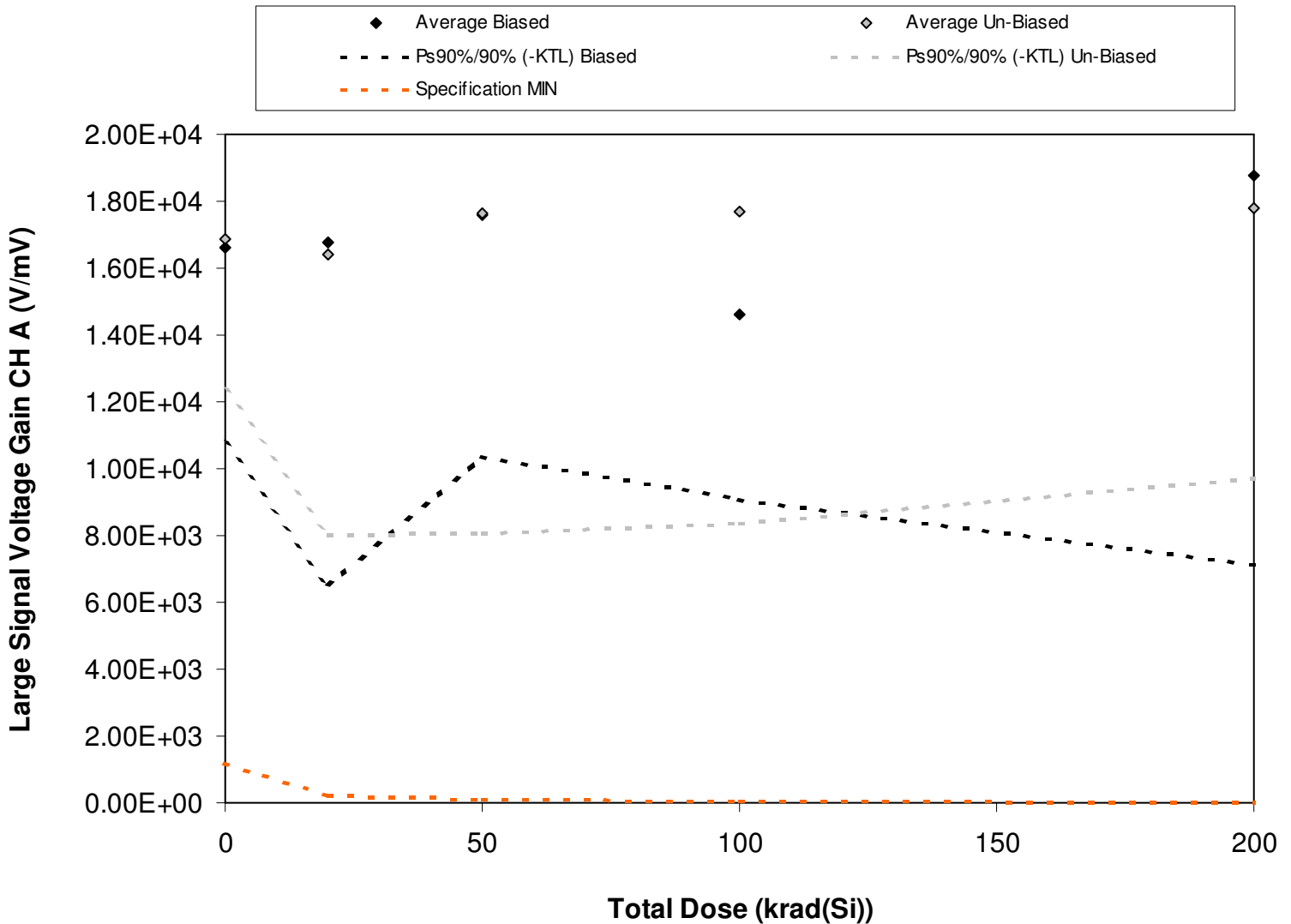

Figure 5.15. Plot of open loop gain for channel A versus total dose. Although the data show a substantial decrease AVOL with total dose, it is not sufficient to fall below the specification value, including after application of the KTL statistics. The solid diamonds are the average of measured data points from the biased sample (devices irradiated with an electrical bias) while the shaded diamonds are the average from the un-biased sample. The black lines show the effects on the data after application of the biased KTL statistics (solid and/or dashed lines) while the gray lines show the effects on the data after application of the unbiased KTL statistics (solid and/or dashed lines). The red dashed lines are the minimum and/or maximum specification values as defined in the datasheet and/or test plan. See Appendix D, Figure D.1 for the data in dB.



Table 5.15. Raw data of the open loop gain for channel A versus total dose, including the statistical analysis, the specification and the status of the testing (pass/fail). See Appendix D, Table D.1 for the data in dB.

Large Signal Voltage Gain CH A (V/mV)	Total Dose (krad(Si))				
	0	20	50	100	200
Device					
1090	1.78E+04	1.62E+04	2.06E+04	1.30E+04	1.75E+04
1092	1.95E+04	1.66E+04	1.94E+04	1.46E+04	1.42E+04
1093	1.65E+04	2.10E+04	1.42E+04	1.79E+04	1.76E+04
1094	1.51E+04	1.11E+04	1.81E+04	1.44E+04	2.57E+04
1095	1.41E+04	1.91E+04	1.57E+04	1.30E+04	1.88E+04
1096	1.58E+04	1.45E+04	1.77E+04	2.18E+04	2.24E+04
1097	1.61E+04	1.40E+04	1.67E+04	2.04E+04	1.56E+04
1098	1.83E+04	1.40E+04	1.91E+04	1.33E+04	1.50E+04
1099	1.51E+04	2.03E+04	2.21E+04	1.64E+04	1.87E+04
1100	1.90E+04	1.92E+04	1.26E+04	1.64E+04	1.71E+04
1106	2.17E+04	1.51E+04	1.83E+04	1.65E+04	1.63E+04
1113	1.50E+04	2.01E+04	1.88E+04	1.56E+04	1.21E+04
Biased Statistics					
Average Biased	1.66E+04	1.68E+04	1.76E+04	1.46E+04	1.87E+04
Std Dev Biased	2.15E+03	3.76E+03	2.64E+03	2.02E+03	4.25E+03
Ps90%/90% (+KTL) Biased	2.25E+04	2.71E+04	2.48E+04	2.01E+04	3.04E+04
Ps90%/90% (-KTL) Biased	1.07E+04	6.48E+03	1.04E+04	9.06E+03	7.11E+03
Un-Biased Statistics					
Average Un-Biased	1.69E+04	1.64E+04	1.76E+04	1.77E+04	1.78E+04
Std Dev Un-Biased	1.66E+03	3.08E+03	3.49E+03	3.40E+03	2.95E+03
Ps90%/90% (+KTL) Un-Biased	2.14E+04	2.48E+04	2.72E+04	2.70E+04	2.59E+04
Ps90%/90% (-KTL) Un-Biased	1.23E+04	7.98E+03	8.06E+03	8.34E+03	9.68E+03
Specification MIN	1.20E+03	2.00E+02	1.00E+02	5.00E+01	2.50E+01
Status	PASS	PASS	PASS	PASS	PASS

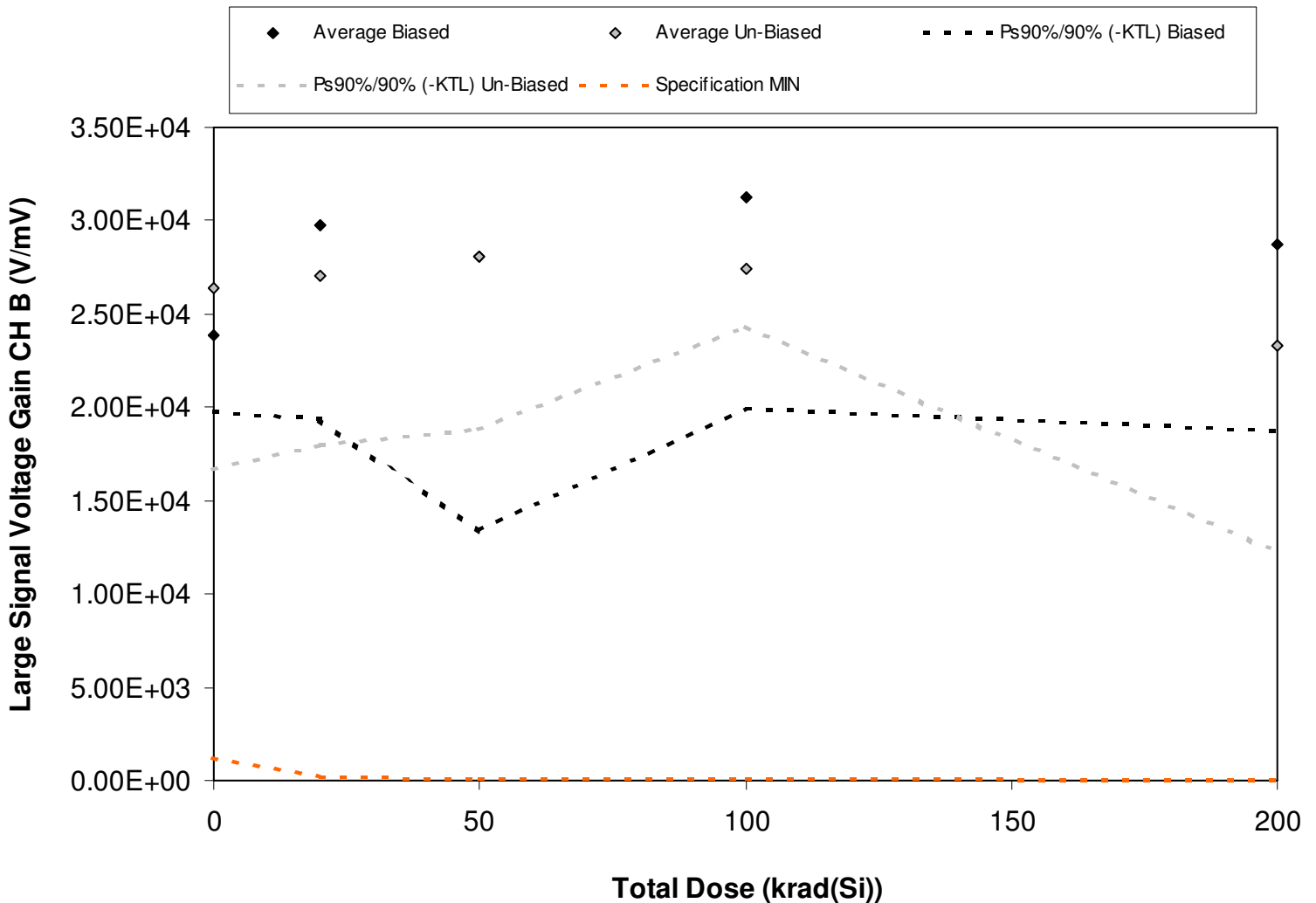

Figure 5.16. Plot of open loop gain for channel B versus total dose. Although the data show a substantial decrease AVOL with total dose, it is not sufficient to fall below the specification value, including after application of the KTL statistics. The solid diamonds are the average of measured data points from the biased sample (devices irradiated with an electrical bias) while the shaded diamonds are the average from the un-biased sample. The black lines show the effects on the data after application of the biased KTL statistics (solid and/or dashed lines) while the gray lines show the effects on the data after application of the unbiased KTL statistics (solid and/or dashed lines). The red dashed lines are the minimum and/or maximum specification values as defined in the datasheet and/or test plan. See Appendix D, Figure D.2 for the data in dB.



Table 5.16. Raw data of the open loop gain for channel B versus total dose, including the statistical analysis, the specification and the status of the testing (pass/fail). . See Appendix D, Table D.2 for the data in dB.

Large Signal Voltage Gain CH B (V/mV)	Total Dose (krad(Si))				
	0	20	50	100	200
Device					
1090	2.39E+04	2.54E+04	2.81E+04	2.77E+04	2.70E+04
1092	2.63E+04	3.36E+04	2.17E+04	2.97E+04	3.15E+04
1093	2.39E+04	2.60E+04	3.66E+04	3.15E+04	3.01E+04
1094	2.29E+04	3.17E+04	2.65E+04	3.82E+04	3.19E+04
1095	2.24E+04	3.21E+04	2.75E+04	2.91E+04	2.32E+04
1096	2.50E+04	2.78E+04	2.41E+04	2.58E+04	2.71E+04
1097	3.17E+04	2.41E+04	2.74E+04	2.70E+04	2.77E+04
1098	2.77E+04	2.47E+04	3.23E+04	2.81E+04	1.89E+04
1099	2.24E+04	3.24E+04	2.58E+04	2.87E+04	2.31E+04
1100	2.50E+04	2.64E+04	3.05E+04	2.76E+04	1.98E+04
1106	2.55E+04	2.94E+04	3.13E+04	2.40E+04	3.24E+04
1113	1.92E+04	2.30E+04	2.44E+04	2.64E+04	3.21E+04
Biased Statistics					
Average Biased	2.39E+04	2.97E+04	2.81E+04	3.12E+04	2.87E+04
Std Dev Biased	1.53E+03	3.78E+03	5.37E+03	4.12E+03	3.66E+03
Ps90%/90% (+KTL) Biased	2.81E+04	4.01E+04	4.28E+04	4.25E+04	3.88E+04
Ps90%/90% (-KTL) Biased	1.97E+04	1.94E+04	1.33E+04	1.99E+04	1.87E+04
Un-Biased Statistics					
Average Un-Biased	2.64E+04	2.71E+04	2.80E+04	2.74E+04	2.33E+04
Std Dev Un-Biased	3.52E+03	3.33E+03	3.36E+03	1.12E+03	4.04E+03
Ps90%/90% (+KTL) Un-Biased	3.60E+04	3.62E+04	3.72E+04	3.05E+04	3.44E+04
Ps90%/90% (-KTL) Un-Biased	1.67E+04	1.80E+04	1.88E+04	2.44E+04	1.22E+04
Specification MIN	1.20E+03	2.00E+02	1.00E+02	5.00E+01	2.50E+01
Status	PASS	PASS	PASS	PASS	PASS

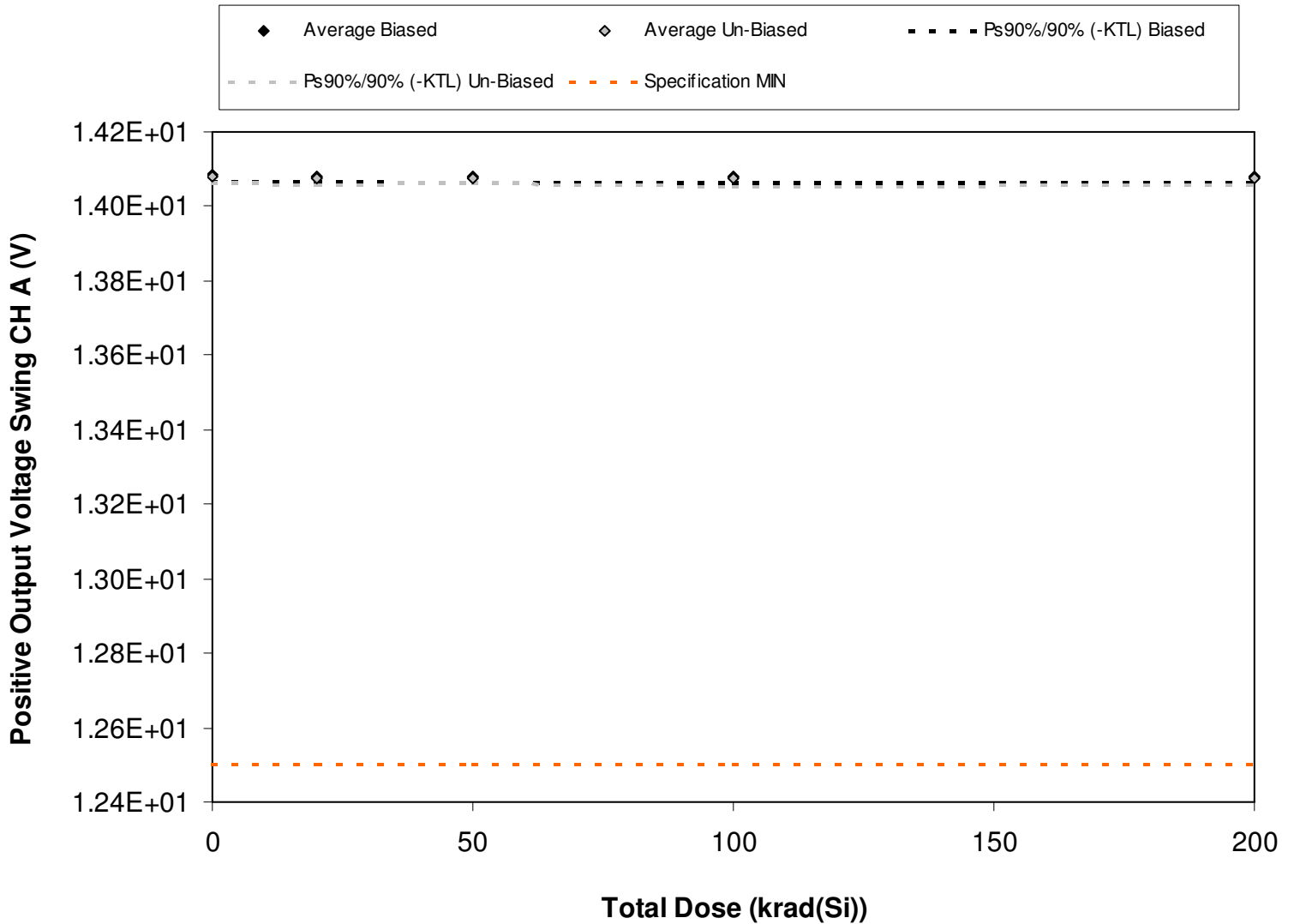

Figure 5.17. Plot of positive output voltage swing for channel A versus total dose. The data show no significant decrease with total dose. The solid diamonds are the average of measured data points from the biased sample (devices irradiated with an electrical bias) while the shaded diamonds are the average from the un-biased sample. The black lines show the effects on the data after application of the biased KTL statistics (solid and/or dashed lines) while the gray lines show the effects on the data after application of the unbiased KTL statistics (solid and/or dashed lines). The red dashed lines are the minimum and/or maximum specification values as defined in the datasheet and/or test plan.



Table 5.17. Raw data of the positive output voltage swing for channel A versus total dose, including the statistical analysis, the specification and the status of the testing (pass/fail).

Positive Output Voltage Swing CH A (V)	Total Dose (krad(Si))				
	0	20	50	100	200
Device					
1090	1.41E+01	1.41E+01	1.41E+01	1.41E+01	1.41E+01
1092	1.41E+01	1.41E+01	1.41E+01	1.41E+01	1.41E+01
1093	1.41E+01	1.41E+01	1.41E+01	1.41E+01	1.41E+01
1094	1.41E+01	1.41E+01	1.41E+01	1.41E+01	1.41E+01
1095	1.41E+01	1.41E+01	1.41E+01	1.41E+01	1.41E+01
1096	1.41E+01	1.41E+01	1.41E+01	1.41E+01	1.41E+01
1097	1.41E+01	1.41E+01	1.41E+01	1.41E+01	1.41E+01
1098	1.41E+01	1.41E+01	1.41E+01	1.41E+01	1.41E+01
1099	1.41E+01	1.41E+01	1.41E+01	1.41E+01	1.41E+01
1100	1.41E+01	1.41E+01	1.41E+01	1.41E+01	1.41E+01
1106	1.41E+01	1.41E+01	1.41E+01	1.41E+01	1.41E+01
1113	1.41E+01	1.41E+01	1.41E+01	1.41E+01	1.41E+01
Biased Statistics					
Average Biased	1.41E+01	1.41E+01	1.41E+01	1.41E+01	1.41E+01
Std Dev Biased	6.80E-03	6.27E-03	6.58E-03	7.13E-03	7.02E-03
Ps90%/90% (+KTL) Biased	1.41E+01	1.41E+01	1.41E+01	1.41E+01	1.41E+01
Ps90%/90% (-KTL) Biased	1.41E+01	1.41E+01	1.41E+01	1.41E+01	1.41E+01
Un-Biased Statistics					
Average Un-Biased	1.41E+01	1.41E+01	1.41E+01	1.41E+01	1.41E+01
Std Dev Un-Biased	6.52E-03	6.72E-03	6.07E-03	7.80E-03	7.40E-03
Ps90%/90% (+KTL) Un-Biased	1.41E+01	1.41E+01	1.41E+01	1.41E+01	1.41E+01
Ps90%/90% (-KTL) Un-Biased	1.41E+01	1.41E+01	1.41E+01	1.41E+01	1.41E+01
Specification MIN	1.25E+01	1.25E+01	1.25E+01	1.25E+01	1.25E+01
Status	PASS	PASS	PASS	PASS	PASS

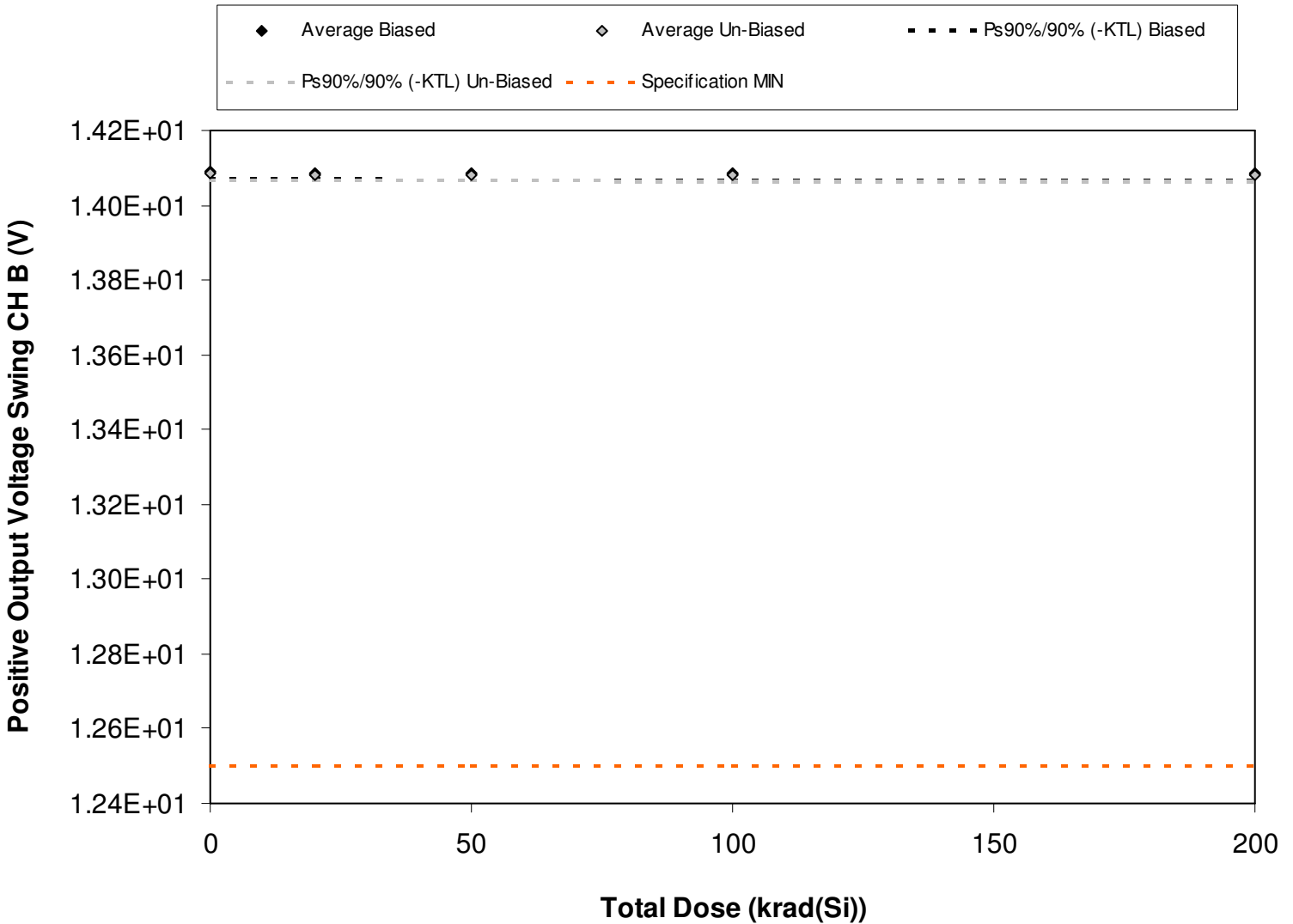

Figure 5.18. Plot of positive output voltage swing for channel B versus total dose. The data show no significant decrease with total dose. The solid diamonds are the average of measured data points from the biased sample (devices irradiated with an electrical bias) while the shaded diamonds are the average from the un-biased sample. The black lines show the effects on the data after application of the biased KTL statistics (solid and/or dashed lines) while the gray lines show the effects on the data after application of the unbiased KTL statistics (solid and/or dashed lines). The red dashed lines are the minimum and/or maximum specification values as defined in the datasheet and/or test plan.



Table 5.18. Raw data of the positive output voltage swing for channel B versus total dose, including the statistical analysis, the specification and the status of the testing (pass/fail).

Positive Output Voltage Swing CH B (V)	Total Dose (krad(Si))				
	0	20	50	100	200
Device					
1090	1.41E+01	1.41E+01	1.41E+01	1.41E+01	1.41E+01
1092	1.41E+01	1.41E+01	1.41E+01	1.41E+01	1.41E+01
1093	1.41E+01	1.41E+01	1.41E+01	1.41E+01	1.41E+01
1094	1.41E+01	1.41E+01	1.41E+01	1.41E+01	1.41E+01
1095	1.41E+01	1.41E+01	1.41E+01	1.41E+01	1.41E+01
1096	1.41E+01	1.41E+01	1.41E+01	1.41E+01	1.41E+01
1097	1.41E+01	1.41E+01	1.41E+01	1.41E+01	1.41E+01
1098	1.41E+01	1.41E+01	1.41E+01	1.41E+01	1.41E+01
1099	1.41E+01	1.41E+01	1.41E+01	1.41E+01	1.41E+01
1100	1.41E+01	1.41E+01	1.41E+01	1.41E+01	1.41E+01
1106	1.41E+01	1.41E+01	1.41E+01	1.41E+01	1.41E+01
1113	1.41E+01	1.41E+01	1.41E+01	1.41E+01	1.41E+01
Biased Statistics					
Average Biased	1.41E+01	1.41E+01	1.41E+01	1.41E+01	1.41E+01
Std Dev Biased	6.82E-03	5.55E-03	6.47E-03	6.93E-03	7.28E-03
Ps90%/90% (+KTL) Biased	1.41E+01	1.41E+01	1.41E+01	1.41E+01	1.41E+01
Ps90%/90% (-KTL) Biased	1.41E+01	1.41E+01	1.41E+01	1.41E+01	1.41E+01
Un-Biased Statistics					
Average Un-Biased	1.41E+01	1.41E+01	1.41E+01	1.41E+01	1.41E+01
Std Dev Un-Biased	6.02E-03	6.39E-03	5.93E-03	7.14E-03	7.43E-03
Ps90%/90% (+KTL) Un-Biased	1.41E+01	1.41E+01	1.41E+01	1.41E+01	1.41E+01
Ps90%/90% (-KTL) Un-Biased	1.41E+01	1.41E+01	1.41E+01	1.41E+01	1.41E+01
Specification MIN	1.25E+01	1.25E+01	1.25E+01	1.25E+01	1.25E+01
Status	PASS	PASS	PASS	PASS	PASS

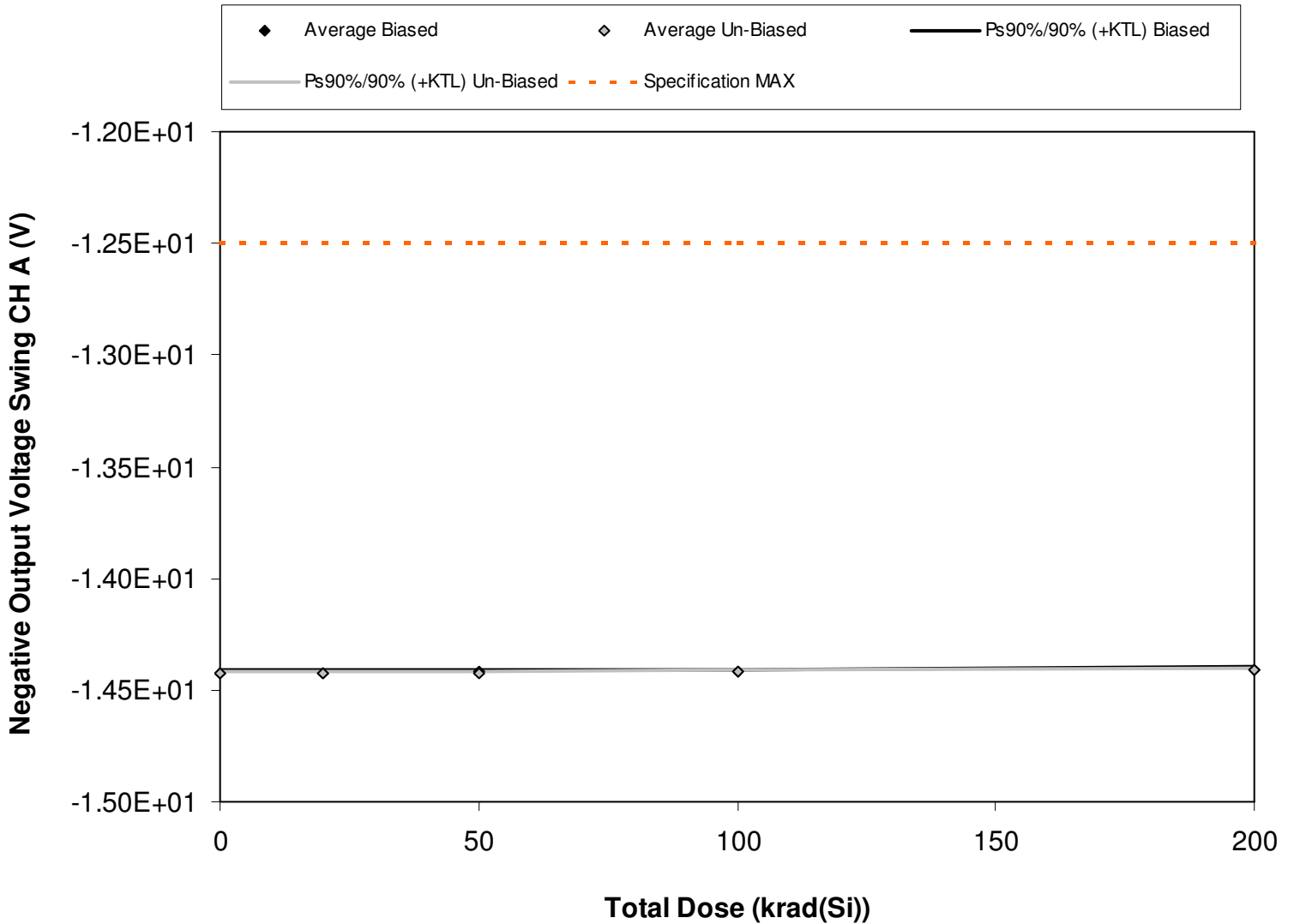

Figure 5.19. Plot of negative output voltage swing for channel A versus total dose. The data show no significant decrease with total dose. The solid diamonds are the average of measured data points from the biased sample (devices irradiated with an electrical bias) while the shaded diamonds are the average from the un-biased sample. The black lines show the effects on the data after application of the biased KTL statistics (solid and/or dashed lines) while the gray lines show the effects on the data after application of the unbiased KTL statistics (solid and/or dashed lines). The red dashed lines are the minimum and/or maximum specification values as defined in the datasheet and/or test plan.



Table 5.19. Raw data of the negative output voltage swing for channel A versus total dose, including the statistical analysis, the specification and the status of the testing (pass/fail).

Negative Output Voltage Swing CH A (V)	Total Dose (krad(Si))				
	0	20	50	100	200
Device					
1090	-1.44E+01	-1.44E+01	-1.44E+01	-1.44E+01	-1.44E+01
1092	-1.44E+01	-1.44E+01	-1.44E+01	-1.44E+01	-1.44E+01
1093	-1.44E+01	-1.44E+01	-1.44E+01	-1.44E+01	-1.44E+01
1094	-1.44E+01	-1.44E+01	-1.44E+01	-1.44E+01	-1.44E+01
1095	-1.44E+01	-1.44E+01	-1.44E+01	-1.44E+01	-1.44E+01
1096	-1.44E+01	-1.44E+01	-1.44E+01	-1.44E+01	-1.44E+01
1097	-1.44E+01	-1.44E+01	-1.44E+01	-1.44E+01	-1.44E+01
1098	-1.44E+01	-1.44E+01	-1.44E+01	-1.44E+01	-1.44E+01
1099	-1.44E+01	-1.44E+01	-1.44E+01	-1.44E+01	-1.44E+01
1100	-1.44E+01	-1.44E+01	-1.44E+01	-1.44E+01	-1.44E+01
1106	-1.44E+01	-1.44E+01	-1.44E+01	-1.44E+01	-1.44E+01
1113	-1.44E+01	-1.44E+01	-1.44E+01	-1.44E+01	-1.44E+01
Biased Statistics					
Average Biased	-1.44E+01	-1.44E+01	-1.44E+01	-1.44E+01	-1.44E+01
Std Dev Biased	3.03E-03	3.63E-03	2.88E-03	3.03E-03	4.88E-03
Ps90%/90% (+KTL) Biased	-1.44E+01	-1.44E+01	-1.44E+01	-1.44E+01	-1.44E+01
Ps90%/90% (-KTL) Biased	-1.44E+01	-1.44E+01	-1.44E+01	-1.44E+01	-1.44E+01
Un-Biased Statistics					
Average Un-Biased	-1.44E+01	-1.44E+01	-1.44E+01	-1.44E+01	-1.44E+01
Std Dev Un-Biased	2.83E-03	2.55E-03	2.41E-03	2.92E-03	1.95E-03
Ps90%/90% (+KTL) Un-Biased	-1.44E+01	-1.44E+01	-1.44E+01	-1.44E+01	-1.44E+01
Ps90%/90% (-KTL) Un-Biased	-1.44E+01	-1.44E+01	-1.44E+01	-1.44E+01	-1.44E+01
Specification MAX	-1.25E+01	-1.25E+01	-1.25E+01	-1.25E+01	-1.25E+01
Status	PASS	PASS	PASS	PASS	PASS

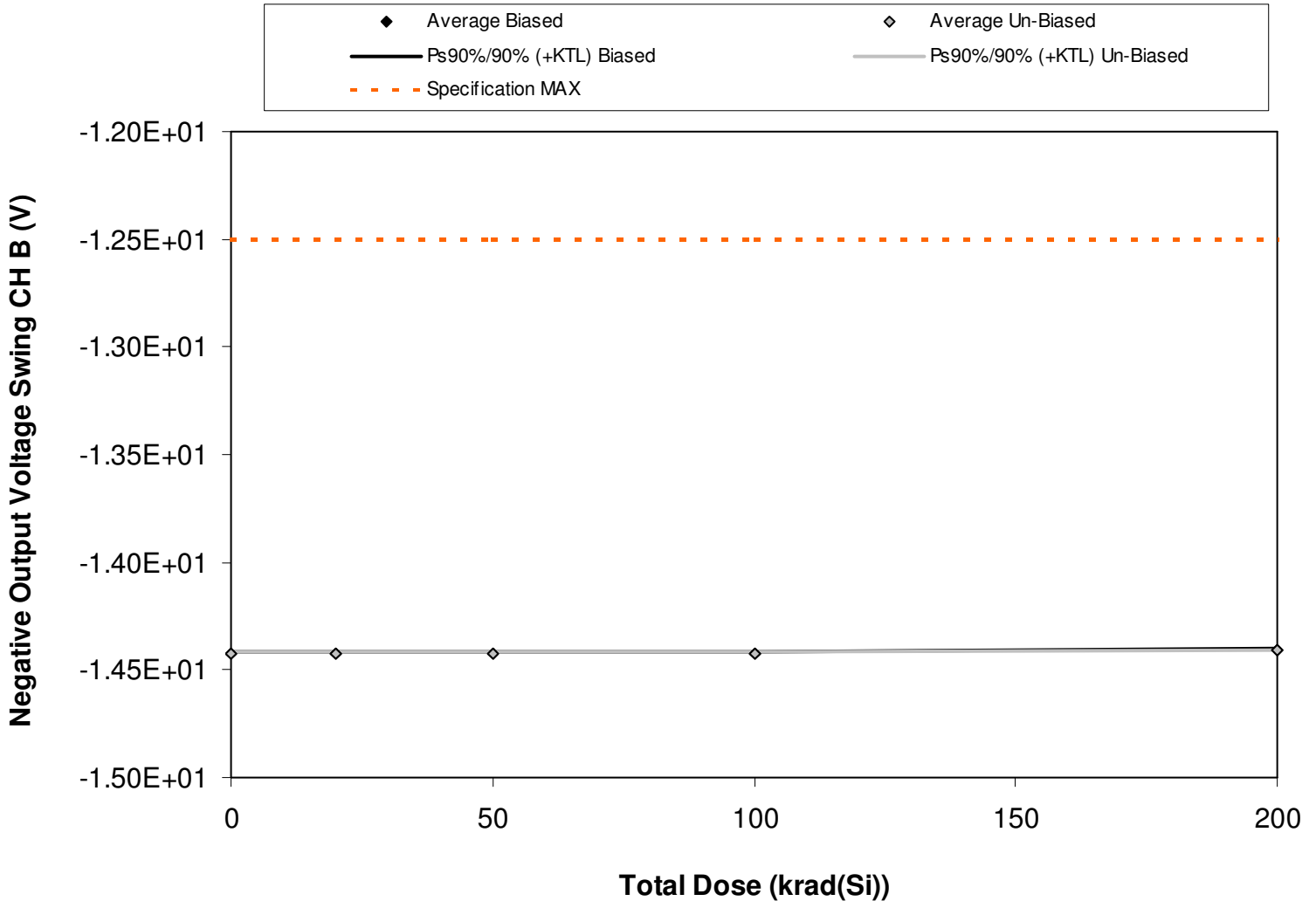

Figure 5.20. Plot of negative output voltage swing for channel B versus total dose. The data show no significant decrease with total dose. The solid diamonds are the average of measured data points from the biased sample (devices irradiated with an electrical bias) while the shaded diamonds are the average from the un-biased sample. The black lines show the effects on the data after application of the biased KTL statistics (solid and/or dashed lines) while the gray lines show the effects on the data after application of the unbiased KTL statistics (solid and/or dashed lines). The red dashed lines are the minimum and/or maximum specification values as defined in the datasheet and/or test plan.



Table 5.20. Raw data of the negative output voltage swing for channel B versus total dose, including the statistical analysis, the specification and the status of the testing (pass/fail).

Negative Output Voltage Swing CH B (V)	Total Dose (krad(Si))				
	0	20	50	100	200
Device					
1090	-1.44E+01	-1.44E+01	-1.44E+01	-1.44E+01	-1.44E+01
1092	-1.44E+01	-1.44E+01	-1.44E+01	-1.44E+01	-1.44E+01
1093	-1.44E+01	-1.44E+01	-1.44E+01	-1.44E+01	-1.44E+01
1094	-1.44E+01	-1.44E+01	-1.44E+01	-1.44E+01	-1.44E+01
1095	-1.44E+01	-1.44E+01	-1.44E+01	-1.44E+01	-1.44E+01
1096	-1.44E+01	-1.44E+01	-1.44E+01	-1.44E+01	-1.44E+01
1097	-1.44E+01	-1.44E+01	-1.44E+01	-1.44E+01	-1.44E+01
1098	-1.44E+01	-1.44E+01	-1.44E+01	-1.44E+01	-1.44E+01
1099	-1.44E+01	-1.44E+01	-1.44E+01	-1.44E+01	-1.44E+01
1100	-1.44E+01	-1.44E+01	-1.44E+01	-1.44E+01	-1.44E+01
1106	-1.44E+01	-1.44E+01	-1.44E+01	-1.44E+01	-1.44E+01
1113	-1.44E+01	-1.44E+01	-1.44E+01	-1.44E+01	-1.44E+01
Biased Statistics					
Average Biased	-1.44E+01	-1.44E+01	-1.44E+01	-1.44E+01	-1.44E+01
Std Dev Biased	3.03E-03	3.63E-03	3.13E-03	3.44E-03	4.47E-03
Ps90%/90% (+KTL) Biased	-1.44E+01	-1.44E+01	-1.44E+01	-1.44E+01	-1.44E+01
Ps90%/90% (-KTL) Biased	-1.44E+01	-1.44E+01	-1.44E+01	-1.44E+01	-1.44E+01
Un-Biased Statistics					
Average Un-Biased	-1.44E+01	-1.44E+01	-1.44E+01	-1.44E+01	-1.44E+01
Std Dev Un-Biased	3.44E-03	2.68E-03	2.77E-03	2.68E-03	2.00E-03
Ps90%/90% (+KTL) Un-Biased	-1.44E+01	-1.44E+01	-1.44E+01	-1.44E+01	-1.44E+01
Ps90%/90% (-KTL) Un-Biased	-1.44E+01	-1.44E+01	-1.44E+01	-1.44E+01	-1.44E+01
Specification MAX	-1.25E+01	-1.25E+01	-1.25E+01	-1.25E+01	-1.25E+01
Status	PASS	PASS	PASS	PASS	PASS

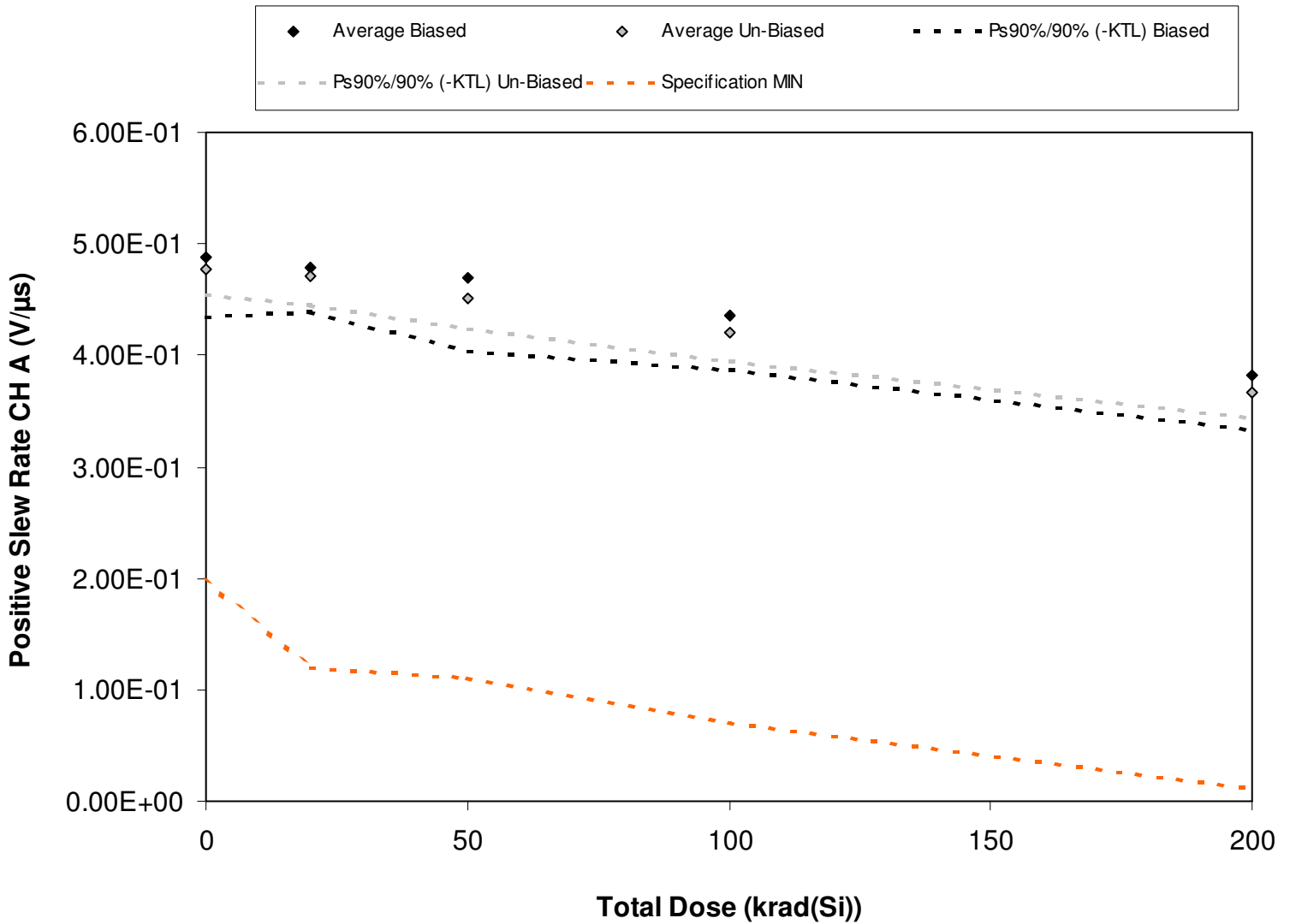

Figure 5.21. Plot of positive slew rate for channel A versus total dose. The data show a moderate decrease with total dose, however not sufficient to fall below the specification, even after application of the KTL statistics. The solid diamonds are the average of measured data points from the biased sample (devices irradiated with an electrical bias) while the shaded diamonds are the average from the un-biased sample. The black lines show the effects on the data after application of the biased KTL statistics (solid and/or dashed lines) while the gray lines show the effects on the data after application of the unbiased KTL statistics (solid and/or dashed lines). The red dashed lines are the minimum and/or maximum specification values as defined in the datasheet and/or test plan.



Table 5.21. Raw data of the positive slew rate for channel A versus total dose, including the statistical analysis, the specification and the status of the testing (pass/fail).

Positive Slew Rate CH A (V/μs)	Total Dose (krad(Si))				
	0	20	50	100	200
Device					
1090	4.82E-01	4.74E-01	4.60E-01	4.31E-01	3.69E-01
1092	4.97E-01	4.94E-01	4.87E-01	4.49E-01	3.92E-01
1093	5.01E-01	4.87E-01	4.84E-01	4.42E-01	3.93E-01
1094	4.56E-01	4.56E-01	4.31E-01	4.07E-01	3.57E-01
1095	5.01E-01	4.85E-01	4.85E-01	4.51E-01	3.98E-01
1096	4.90E-01	4.84E-01	4.60E-01	4.24E-01	3.76E-01
1097	4.68E-01	4.60E-01	4.35E-01	4.09E-01	3.63E-01
1098	4.76E-01	4.76E-01	4.58E-01	4.32E-01	3.74E-01
1099	4.79E-01	4.70E-01	4.54E-01	4.24E-01	3.68E-01
1100	4.73E-01	4.64E-01	4.50E-01	4.12E-01	3.55E-01
1106	4.75E-01	4.88E-01	4.87E-01	4.82E-01	4.80E-01
1113	4.77E-01	4.71E-01	4.69E-01	4.72E-01	4.69E-01
Biased Statistics					
Average Biased	4.87E-01	4.79E-01	4.69E-01	4.36E-01	3.82E-01
Std Dev Biased	1.92E-02	1.48E-02	2.41E-02	1.80E-02	1.78E-02
Ps90%/90% (+KTL) Biased	5.40E-01	5.20E-01	5.36E-01	4.85E-01	4.31E-01
Ps90%/90% (-KTL) Biased	4.35E-01	4.39E-01	4.03E-01	3.87E-01	3.33E-01
Un-Biased Statistics					
Average Un-Biased	4.77E-01	4.71E-01	4.51E-01	4.20E-01	3.67E-01
Std Dev Un-Biased	8.23E-03	9.55E-03	9.94E-03	9.50E-03	8.53E-03
Ps90%/90% (+KTL) Un-Biased	5.00E-01	4.97E-01	4.79E-01	4.46E-01	3.91E-01
Ps90%/90% (-KTL) Un-Biased	4.55E-01	4.45E-01	4.24E-01	3.94E-01	3.44E-01
Specification MIN	2.00E-01	1.20E-01	1.10E-01	7.00E-02	1.00E-02
Status	PASS	PASS	PASS	PASS	PASS

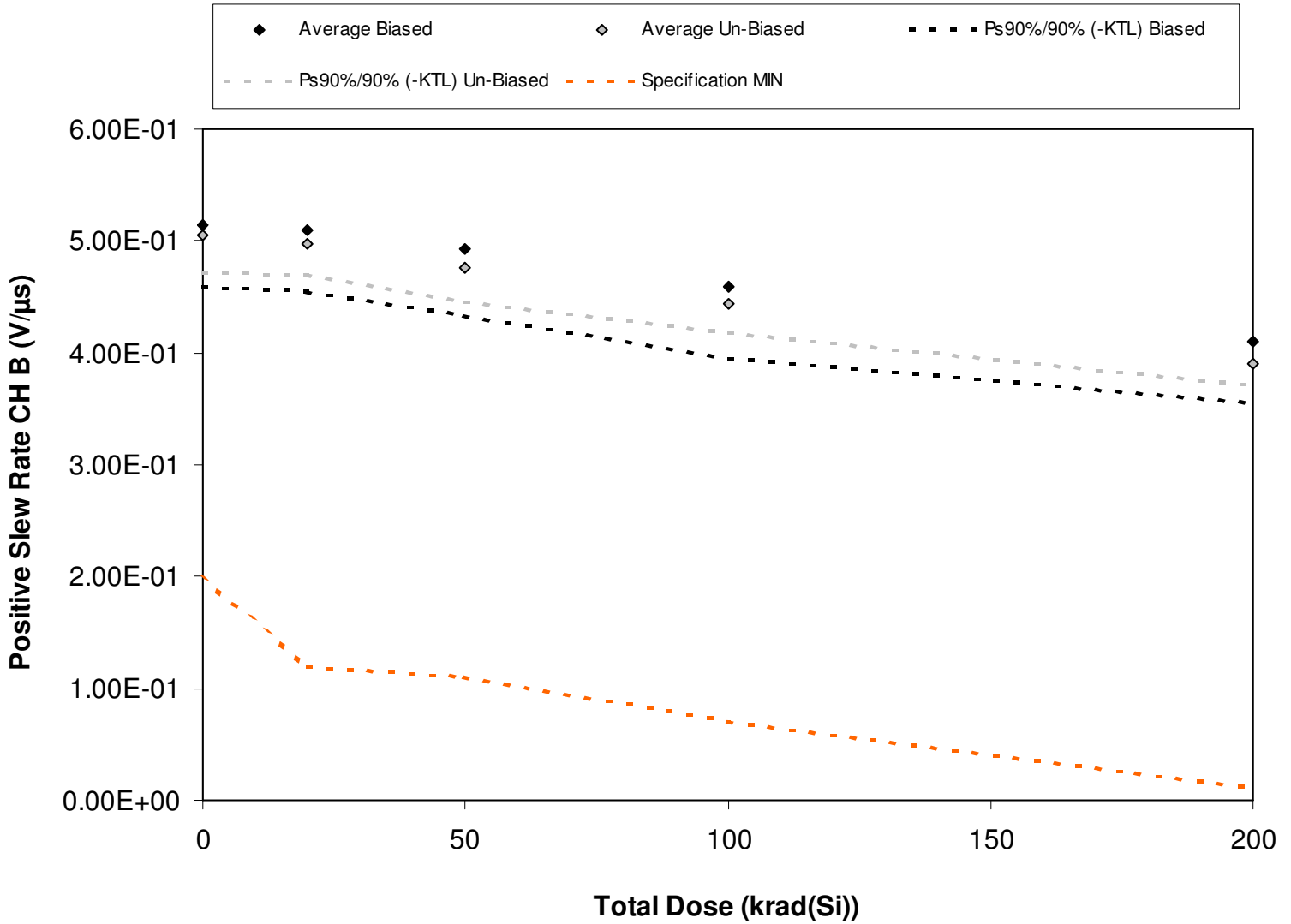

Figure 5.22. Plot of positive slew rate for channel B versus total dose. The data show a moderate decrease with total dose, however not sufficient to fall below the specification, even after application of the KTL statistics. The solid diamonds are the average of measured data points from the biased sample (devices irradiated with an electrical bias) while the shaded diamonds are the average from the un-biased sample. The black lines show the effects on the data after application of the biased KTL statistics (solid and/or dashed lines) while the gray lines show the effects on the data after application of the unbiased KTL statistics (solid and/or dashed lines). The red dashed lines are the minimum and/or maximum specification values as defined in the datasheet and/or test plan.



Table 5.22. Raw data of the positive slew rate for channel B versus total dose, including the statistical analysis, the specification and the status of the testing (pass/fail).

Positive Slew Rate CH B (V/ μ s)	Total Dose (krad(Si))				
	0	20	50	100	200
Device					
1090	5.10E-01	5.11E-01	4.88E-01	4.54E-01	4.07E-01
1092	5.35E-01	5.24E-01	5.07E-01	4.76E-01	4.21E-01
1093	5.20E-01	5.07E-01	4.99E-01	4.69E-01	4.17E-01
1094	4.82E-01	4.77E-01	4.57E-01	4.21E-01	3.77E-01
1095	5.27E-01	5.27E-01	5.12E-01	4.78E-01	4.29E-01
1096	5.07E-01	5.08E-01	4.86E-01	4.49E-01	3.99E-01
1097	4.89E-01	4.81E-01	4.59E-01	4.27E-01	3.84E-01
1098	5.02E-01	4.99E-01	4.86E-01	4.50E-01	3.96E-01
1099	5.23E-01	4.99E-01	4.75E-01	4.45E-01	3.87E-01
1100	5.04E-01	4.98E-01	4.76E-01	4.45E-01	3.84E-01
1106	5.18E-01	5.13E-01	5.07E-01	5.15E-01	5.04E-01
1113	5.05E-01	5.11E-01	5.14E-01	5.02E-01	5.14E-01
Biased Statistics					
Average Biased	5.15E-01	5.09E-01	4.93E-01	4.60E-01	4.10E-01
Std Dev Biased	2.05E-02	1.99E-02	2.19E-02	2.35E-02	2.02E-02
Ps90%/90% (+KTL) Biased	5.71E-01	5.64E-01	5.53E-01	5.24E-01	4.66E-01
Ps90%/90% (-KTL) Biased	4.59E-01	4.55E-01	4.33E-01	3.95E-01	3.55E-01
Un-Biased Statistics					
Average Un-Biased	5.05E-01	4.97E-01	4.76E-01	4.43E-01	3.90E-01
Std Dev Un-Biased	1.22E-02	9.82E-03	1.11E-02	9.34E-03	7.04E-03
Ps90%/90% (+KTL) Un-Biased	5.38E-01	5.24E-01	5.07E-01	4.69E-01	4.09E-01
Ps90%/90% (-KTL) Un-Biased	4.72E-01	4.70E-01	4.46E-01	4.18E-01	3.71E-01
Specification MIN	2.00E-01	1.20E-01	1.10E-01	7.00E-02	1.00E-02
Status	PASS	PASS	PASS	PASS	PASS

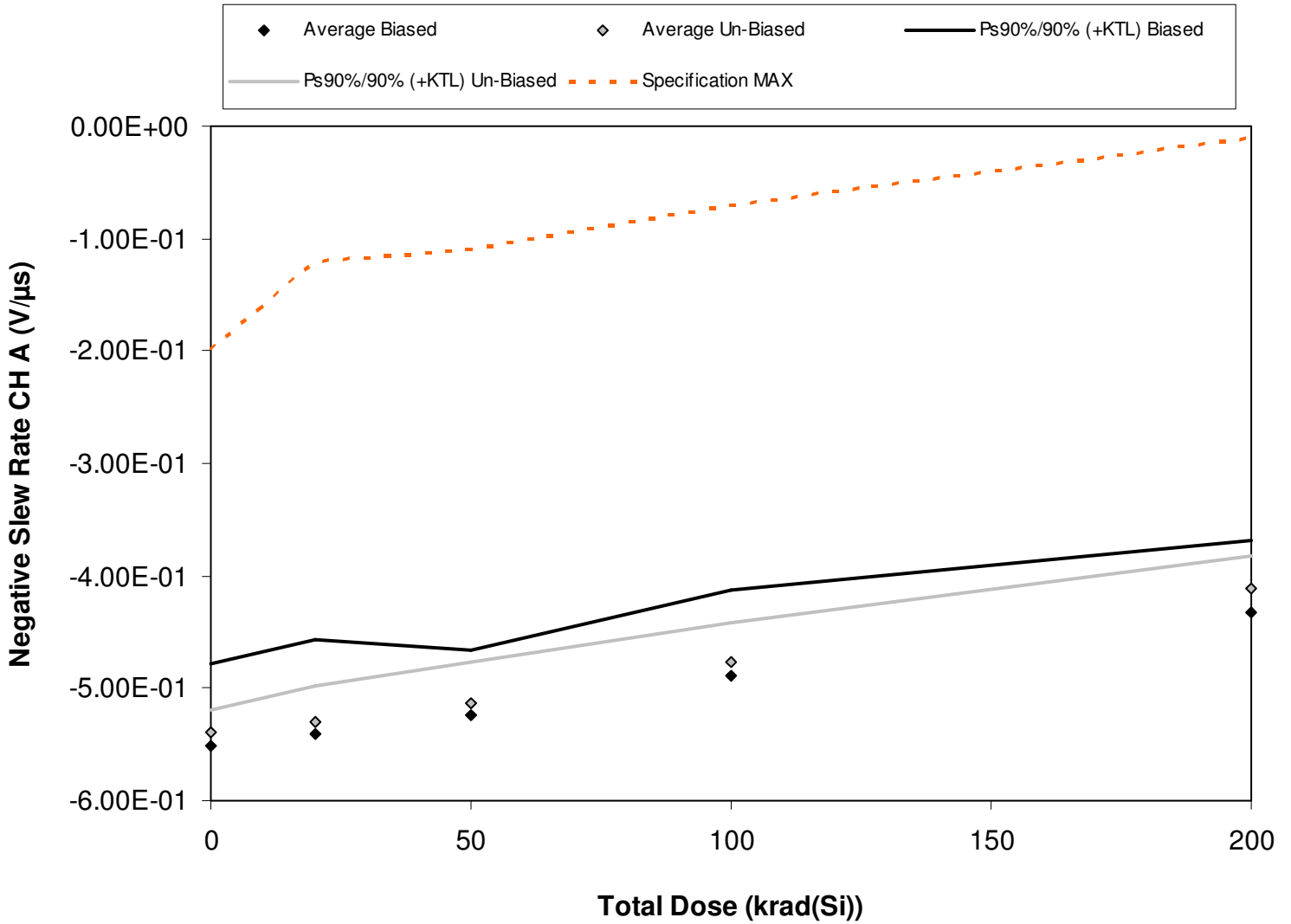

Figure 5.23. Plot of negative slew rate for channel A versus total dose. The data show a moderate increase with total dose, however not sufficient to exceed the specification, even after application of the KTL statistics. The solid diamonds are the average of measured data points from the biased sample (devices irradiated with an electrical bias) while the shaded diamonds are the average from the un-biased sample. The black lines show the effects on the data after application of the biased KTL statistics (solid and/or dashed lines) while the gray lines show the effects on the data after application of the unbiased KTL statistics (solid and/or dashed lines). The red dashed lines are the minimum and/or maximum specification values as defined in the datasheet and/or test plan.



Table 5.23. Raw data of the negative slew rate for channel A versus total dose, including the statistical analysis, the specification and the status of the testing (pass/fail).

Negative Slew Rate CH A (V/ μ s)	Total Dose (krad(Si))				
	0	20	50	100	200
Device					
1090	-5.38E-01	-5.26E-01	-5.21E-01	-4.83E-01	-4.17E-01
1092	-5.67E-01	-5.67E-01	-5.41E-01	-5.00E-01	-4.44E-01
1093	-5.73E-01	-5.43E-01	-5.29E-01	-5.05E-01	-4.49E-01
1094	-5.10E-01	-4.97E-01	-4.89E-01	-4.44E-01	-3.99E-01
1095	-5.65E-01	-5.71E-01	-5.38E-01	-5.14E-01	-4.52E-01
1096	-5.35E-01	-5.39E-01	-5.06E-01	-4.84E-01	-4.23E-01
1097	-5.32E-01	-5.14E-01	-4.94E-01	-4.60E-01	-4.09E-01
1098	-5.40E-01	-5.40E-01	-5.22E-01	-4.91E-01	-4.22E-01
1099	-5.51E-01	-5.32E-01	-5.28E-01	-4.81E-01	-4.04E-01
1100	-5.37E-01	-5.22E-01	-5.13E-01	-4.68E-01	-3.99E-01
1106	-5.53E-01	-5.50E-01	-5.56E-01	-5.39E-01	-5.40E-01
1113	-5.39E-01	-5.49E-01	-5.37E-01	-5.37E-01	-5.41E-01
Biased Statistics					
Average Biased	-5.51E-01	-5.41E-01	-5.24E-01	-4.89E-01	-4.32E-01
Std Dev Biased	2.64E-02	3.06E-02	2.09E-02	2.77E-02	2.32E-02
Ps90%/90% (+KTL) Biased	-4.78E-01	-4.57E-01	-4.66E-01	-4.13E-01	-3.69E-01
Ps90%/90% (-KTL) Biased	-6.23E-01	-6.25E-01	-5.81E-01	-5.65E-01	-4.96E-01
Un-Biased Statistics					
Average Un-Biased	-5.39E-01	-5.29E-01	-5.13E-01	-4.77E-01	-4.11E-01
Std Dev Un-Biased	7.31E-03	1.12E-02	1.34E-02	1.26E-02	1.07E-02
Ps90%/90% (+KTL) Un-Biased	-5.19E-01	-4.99E-01	-4.76E-01	-4.42E-01	-3.82E-01
Ps90%/90% (-KTL) Un-Biased	-5.59E-01	-5.60E-01	-5.49E-01	-5.11E-01	-4.41E-01
Specification MAX	-2.00E-01	-1.20E-01	-1.10E-01	-7.00E-02	-1.00E-02
Status	PASS	PASS	PASS	PASS	PASS

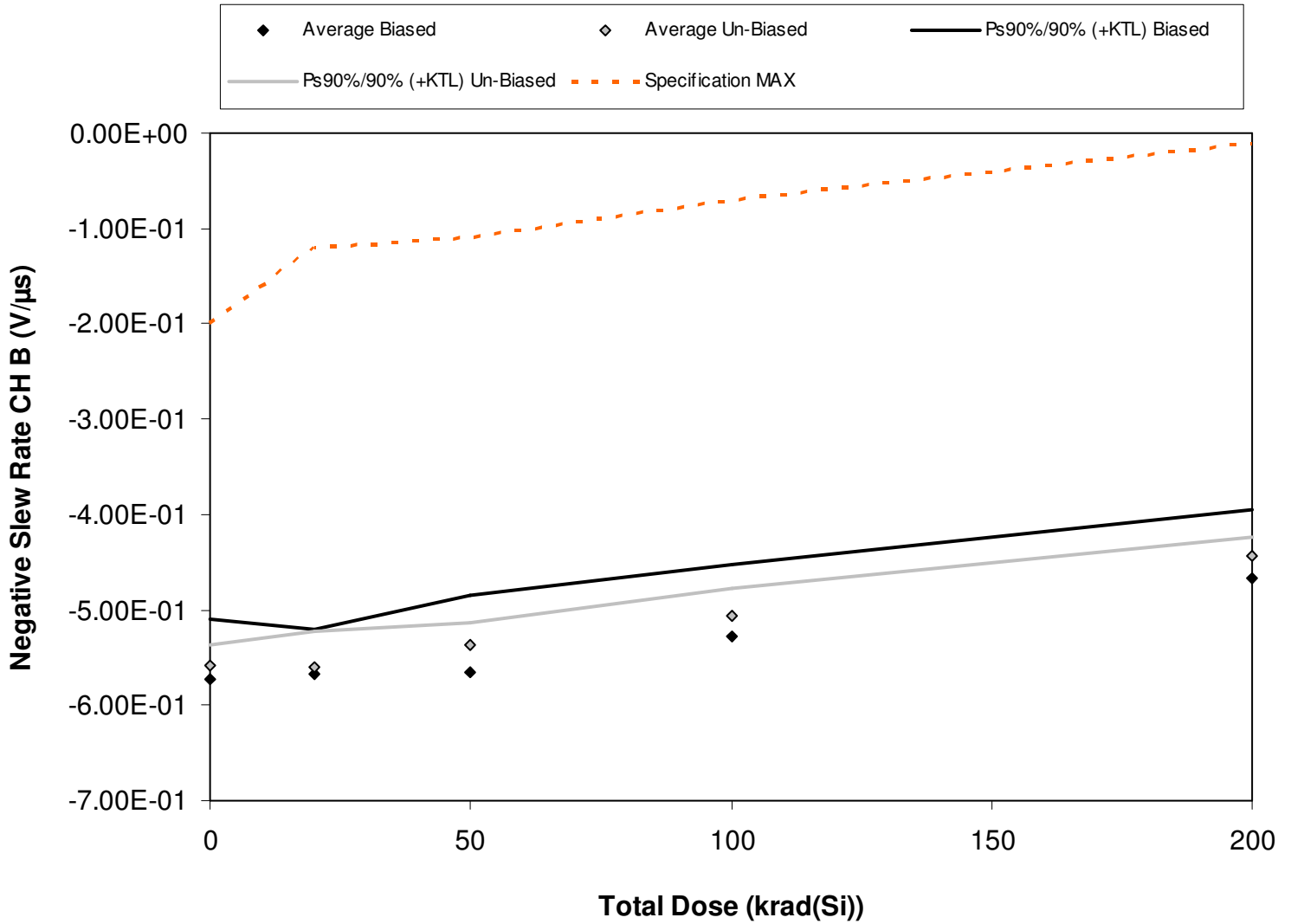

Figure 5.24. Plot of negative slew rate for channel B versus total dose. The data show a moderate increase with total dose, however not sufficient to exceed the specification, even after application of the KTL statistics. The solid diamonds are the average of measured data points from the biased sample (devices irradiated with an electrical bias) while the shaded diamonds are the average from the un-biased sample. The black lines show the effects on the data after application of the biased KTL statistics (solid and/or dashed lines) while the gray lines show the effects on the data after application of the unbiased KTL statistics (solid and/or dashed lines). The red dashed lines are the minimum and/or maximum specification values as defined in the datasheet and/or test plan.



Table 5.24. Raw data of the negative slew rate for channel B versus total dose, including the statistical analysis, the specification and the status of the testing (pass/fail).

Negative Slew Rate CH B (V/μs)	Total Dose (krad(Si))				
	0	20	50	100	200
Device					
1090	-5.71E-01	-5.66E-01	-5.64E-01	-5.33E-01	-4.51E-01
1092	-5.87E-01	-5.80E-01	-5.80E-01	-5.32E-01	-4.82E-01
1093	-5.75E-01	-5.66E-01	-5.53E-01	-5.37E-01	-4.74E-01
1094	-5.36E-01	-5.40E-01	-5.26E-01	-4.82E-01	-4.30E-01
1095	-5.97E-01	-5.84E-01	-6.06E-01	-5.58E-01	-4.96E-01
1096	-5.55E-01	-5.79E-01	-5.48E-01	-5.07E-01	-4.50E-01
1097	-5.55E-01	-5.40E-01	-5.25E-01	-4.96E-01	-4.34E-01
1098	-5.48E-01	-5.58E-01	-5.35E-01	-5.21E-01	-4.47E-01
1099	-5.62E-01	-5.63E-01	-5.42E-01	-5.08E-01	-4.48E-01
1100	-5.67E-01	-5.59E-01	-5.33E-01	-4.97E-01	-4.37E-01
1106	-5.78E-01	-5.70E-01	-5.82E-01	-5.69E-01	-5.98E-01
1113	-5.79E-01	-5.63E-01	-5.81E-01	-5.85E-01	-5.72E-01
Biased Statistics					
Average Biased	-5.73E-01	-5.67E-01	-5.66E-01	-5.28E-01	-4.67E-01
Std Dev Biased	2.32E-02	1.72E-02	2.99E-02	2.80E-02	2.62E-02
Ps90%/90% (+KTL) Biased	-5.10E-01	-5.20E-01	-4.84E-01	-4.52E-01	-3.95E-01
Ps90%/90% (-KTL) Biased	-6.37E-01	-6.14E-01	-6.48E-01	-6.05E-01	-5.38E-01
Un-Biased Statistics					
Average Un-Biased	-5.57E-01	-5.60E-01	-5.37E-01	-5.06E-01	-4.43E-01
Std Dev Un-Biased	7.30E-03	1.39E-02	8.79E-03	1.01E-02	7.19E-03
Ps90%/90% (+KTL) Un-Biased	-5.37E-01	-5.22E-01	-5.12E-01	-4.78E-01	-4.23E-01
Ps90%/90% (-KTL) Un-Biased	-5.77E-01	-5.98E-01	-5.61E-01	-5.34E-01	-4.63E-01
Specification MAX	-2.00E-01	-1.20E-01	-1.10E-01	-7.00E-02	-1.00E-02
Status	PASS	PASS	PASS	PASS	PASS

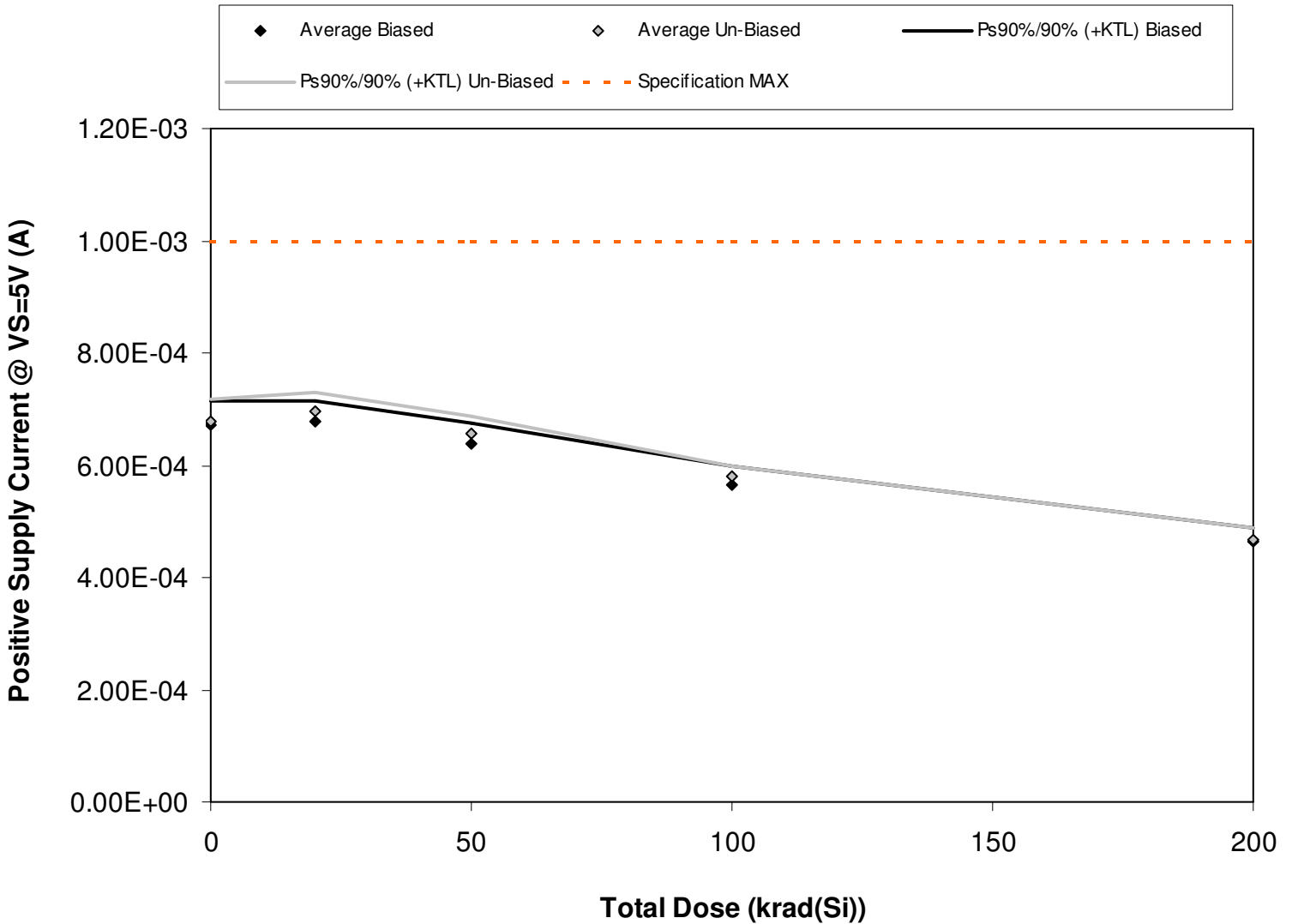

Figure 5.25. Plot of positive supply current at 5V versus total dose. The data show a slight decrease (improvement) with total dose. The solid diamonds are the average of measured data points from the biased sample (devices irradiated with an electrical bias) while the shaded diamonds are the average from the unbiased sample. The black line(s) show the effects on the data after application of the biased KTL statistics (solid and/or dashed lines) while the gray line(s) show the effects on the data after application of the unbiased KTL statistics (solid and/or dashed lines). The red dashed line(s) are the minimum and/or maximum specification values as defined in the datasheet and/or test plan.



Table 5.25. Raw data of the positive supply current at 5V versus total dose, including the statistical analysis, the specification and the status of the testing (pass/fail).

Positive Supply Current @ VS=5V (A)	Total Dose (krad(Si))				
	0	20	50	100	200
Device					
1090	6.62E-04	6.74E-04	6.35E-04	5.58E-04	4.56E-04
1092	6.81E-04	6.86E-04	6.47E-04	5.70E-04	4.65E-04
1093	6.60E-04	6.69E-04	6.31E-04	5.61E-04	4.61E-04
1094	6.57E-04	6.67E-04	6.26E-04	5.53E-04	4.60E-04
1095	6.94E-04	6.97E-04	6.57E-04	5.83E-04	4.80E-04
1096	6.81E-04	7.03E-04	6.63E-04	5.89E-04	4.75E-04
1097	6.70E-04	6.89E-04	6.46E-04	5.76E-04	4.73E-04
1098	6.55E-04	6.79E-04	6.39E-04	5.72E-04	4.56E-04
1099	6.86E-04	7.02E-04	6.62E-04	5.83E-04	4.62E-04
1100	6.93E-04	7.09E-04	6.66E-04	5.81E-04	4.66E-04
1106	6.61E-04	6.61E-04	6.63E-04	6.61E-04	6.60E-04
1113	6.99E-04	6.98E-04	6.98E-04	6.97E-04	6.97E-04
Biased Statistics					
Average Biased	6.71E-04	6.79E-04	6.39E-04	5.65E-04	4.64E-04
Std Dev Biased	1.60E-05	1.27E-05	1.26E-05	1.18E-05	9.29E-06
Ps90%/90% (+KTL) Biased	7.15E-04	7.13E-04	6.74E-04	5.97E-04	4.90E-04
Ps90%/90% (-KTL) Biased	6.27E-04	6.44E-04	6.05E-04	5.33E-04	4.39E-04
Un-Biased Statistics					
Average Un-Biased	6.77E-04	6.96E-04	6.55E-04	5.80E-04	4.66E-04
Std Dev Un-Biased	1.49E-05	1.22E-05	1.19E-05	6.53E-06	7.83E-06
Ps90%/90% (+KTL) Un-Biased	7.18E-04	7.30E-04	6.88E-04	5.98E-04	4.88E-04
Ps90%/90% (-KTL) Un-Biased	6.36E-04	6.63E-04	6.22E-04	5.62E-04	4.45E-04
Specification MAX	1.00E-03	1.00E-03	1.00E-03	1.00E-03	1.00E-03
Status	PASS	PASS	PASS	PASS	PASS

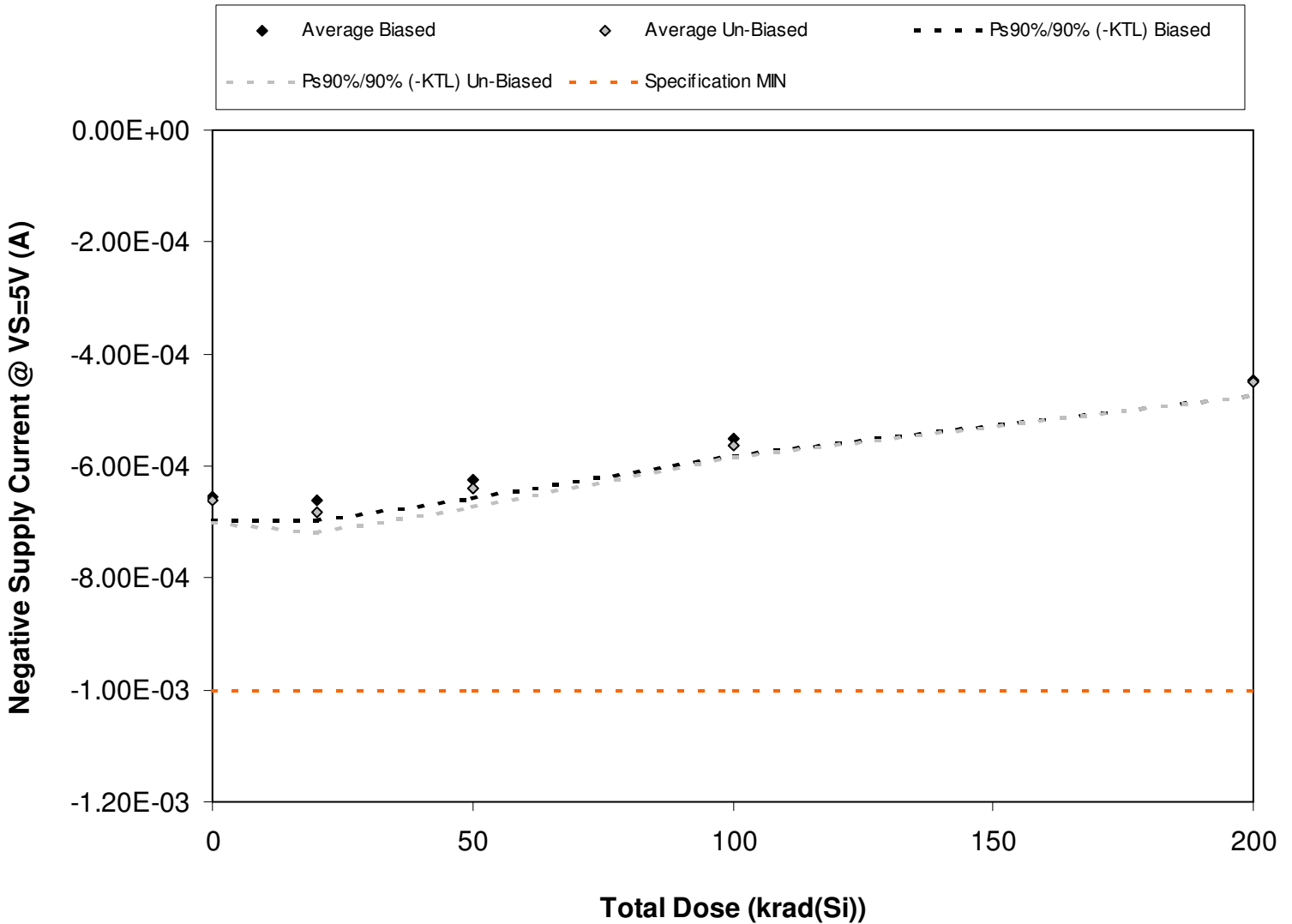

Figure 5.26. Plot of the negative supply current at 5V versus total dose. The data show a slight increase (improvement) with total dose. The solid diamonds are the average of measured data points from the biased sample (devices irradiated with an electrical bias) while the shaded diamonds are the average from the unbiased sample. The black line(s) show the effects on the data after application of the biased KTL statistics (solid and/or dashed lines) while the gray line(s) show the effects on the data after application of the unbiased KTL statistics (solid and/or dashed lines). The red dashed line(s) are the minimum and/or maximum specification values as defined in the datasheet and/or test plan.



Table 5.26. Raw data of the negative supply current at 5V versus total dose, including the statistical analysis, the specification and the status of the testing (pass/fail).

Negative Supply Current @ VS=5V (A)	Total Dose (krad(Si))				
	0	20	50	100	200
Device					
1090	-6.47E-04	-6.56E-04	-6.18E-04	-5.42E-04	-4.37E-04
1092	-6.64E-04	-6.68E-04	-6.30E-04	-5.54E-04	-4.50E-04
1093	-6.45E-04	-6.51E-04	-6.17E-04	-5.45E-04	-4.44E-04
1094	-6.41E-04	-6.50E-04	-6.10E-04	-5.39E-04	-4.43E-04
1095	-6.78E-04	-6.81E-04	-6.42E-04	-5.69E-04	-4.63E-04
1096	-6.64E-04	-6.90E-04	-6.46E-04	-5.70E-04	-4.60E-04
1097	-6.53E-04	-6.72E-04	-6.33E-04	-5.58E-04	-4.56E-04
1098	-6.43E-04	-6.63E-04	-6.23E-04	-5.52E-04	-4.37E-04
1099	-6.71E-04	-6.87E-04	-6.46E-04	-5.65E-04	-4.49E-04
1100	-6.79E-04	-6.95E-04	-6.52E-04	-5.69E-04	-4.54E-04
1106	-6.45E-04	-6.47E-04	-6.47E-04	-6.44E-04	-6.44E-04
1113	-6.84E-04	-6.83E-04	-6.83E-04	-6.83E-04	-6.81E-04
Biased Statistics					
Average Biased	-6.55E-04	-6.61E-04	-6.23E-04	-5.50E-04	-4.47E-04
Std Dev Biased	1.56E-05	1.32E-05	1.26E-05	1.21E-05	9.86E-06
Ps90%/90% (+KTL) Biased	-6.12E-04	-6.25E-04	-5.89E-04	-5.17E-04	-4.20E-04
Ps90%/90% (-KTL) Biased	-6.98E-04	-6.97E-04	-6.58E-04	-5.83E-04	-4.74E-04
Un-Biased Statistics					
Average Un-Biased	-6.62E-04	-6.81E-04	-6.40E-04	-5.63E-04	-4.51E-04
Std Dev Un-Biased	1.43E-05	1.34E-05	1.18E-05	7.66E-06	8.87E-06
Ps90%/90% (+KTL) Un-Biased	-6.23E-04	-6.45E-04	-6.08E-04	-5.42E-04	-4.27E-04
Ps90%/90% (-KTL) Un-Biased	-7.01E-04	-7.18E-04	-6.72E-04	-5.84E-04	-4.76E-04
Specification MIN	-1.00E-03	-1.00E-03	-1.00E-03	-1.00E-03	-1.00E-03
Status	PASS	PASS	PASS	PASS	PASS

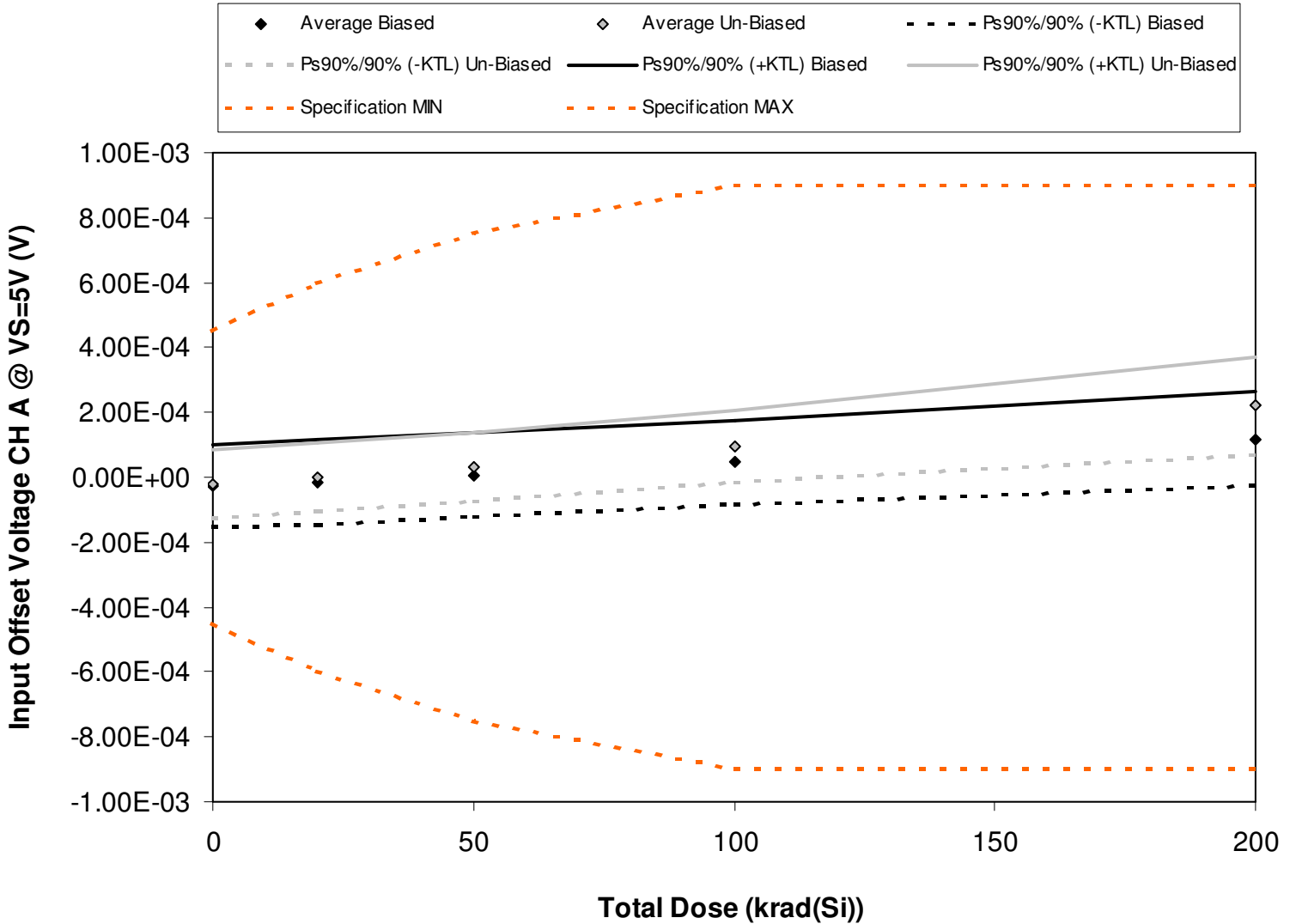

Figure 5.27. Plot of input offset voltage at 5V for channel A versus total dose. The data show a slight increase with total dose, however not sufficient for the parameter to exceed specification, including after application of the KTL statistics. The solid diamonds are the average of measured data points from the biased sample (devices irradiated with an electrical bias) while the shaded diamonds are the average from the un-biased sample. The black line(s) show the effects on the data after application of the biased KTL statistics (solid and/or dashed lines) while the gray line(s) show the effects on the data after application of the unbiased KTL statistics (solid and/or dashed lines). The red dashed line(s) are the minimum and/or maximum specification values as defined in the datasheet and/or test plan.



Table 5.27. Raw data of the input offset voltage at 5V for channel A versus total dose, including the statistical analysis, the specification and the status of the testing (pass/fail).

Input Offset Voltage CH A @ VS=5V (V)	Total Dose (krad(Si))				
	0	20	50	100	200
Device					
1090	-4.81E-05	-4.00E-05	-1.55E-05	2.58E-05	1.09E-04
1092	-1.11E-05	-1.21E-06	2.19E-05	5.46E-05	1.18E-04
1093	4.76E-05	5.64E-05	7.61E-05	1.02E-04	1.52E-04
1094	-4.37E-05	-2.69E-05	4.83E-06	6.86E-05	1.78E-04
1095	-7.52E-05	-6.97E-05	-5.29E-05	-2.35E-05	3.63E-05
1096	2.34E-05	3.98E-05	7.49E-05	1.23E-04	2.25E-04
1097	5.19E-06	2.50E-05	6.27E-05	1.34E-04	2.62E-04
1098	-4.49E-05	-2.69E-05	1.21E-07	4.55E-05	1.37E-04
1099	-7.14E-05	-5.29E-05	-1.26E-05	6.13E-05	2.06E-04
1100	-8.94E-06	9.54E-06	4.65E-05	1.19E-04	2.77E-04
1106	6.99E-05	6.97E-05	7.09E-05	6.83E-05	6.87E-05
1113	-4.38E-05	-4.25E-05	-4.25E-05	-4.27E-05	-4.37E-05
Biased Statistics					
Average Biased	-2.61E-05	-1.63E-05	6.88E-06	4.55E-05	1.19E-04
Std Dev Biased	4.71E-05	4.75E-05	4.77E-05	4.73E-05	5.35E-05
Ps90%/90% (+KTL) Biased	1.03E-04	1.14E-04	1.38E-04	1.75E-04	2.65E-04
Ps90%/90% (-KTL) Biased	-1.55E-04	-1.47E-04	-1.24E-04	-8.43E-05	-2.81E-05
Un-Biased Statistics					
Average Un-Biased	-1.93E-05	-1.09E-06	3.43E-05	9.66E-05	2.21E-04
Std Dev Un-Biased	3.84E-05	3.81E-05	3.86E-05	4.02E-05	5.50E-05
Ps90%/90% (+KTL) Un-Biased	8.60E-05	1.03E-04	1.40E-04	2.07E-04	3.72E-04
Ps90%/90% (-KTL) Un-Biased	-1.25E-04	-1.06E-04	-7.15E-05	-1.36E-05	7.05E-05
Specification MIN	-4.50E-04	-6.00E-04	-7.50E-04	-9.00E-04	-9.00E-04
Status	PASS	PASS	PASS	PASS	PASS
Specification MAX	4.50E-04	6.00E-04	7.50E-04	9.00E-04	9.00E-04
Status	PASS	PASS	PASS	PASS	PASS

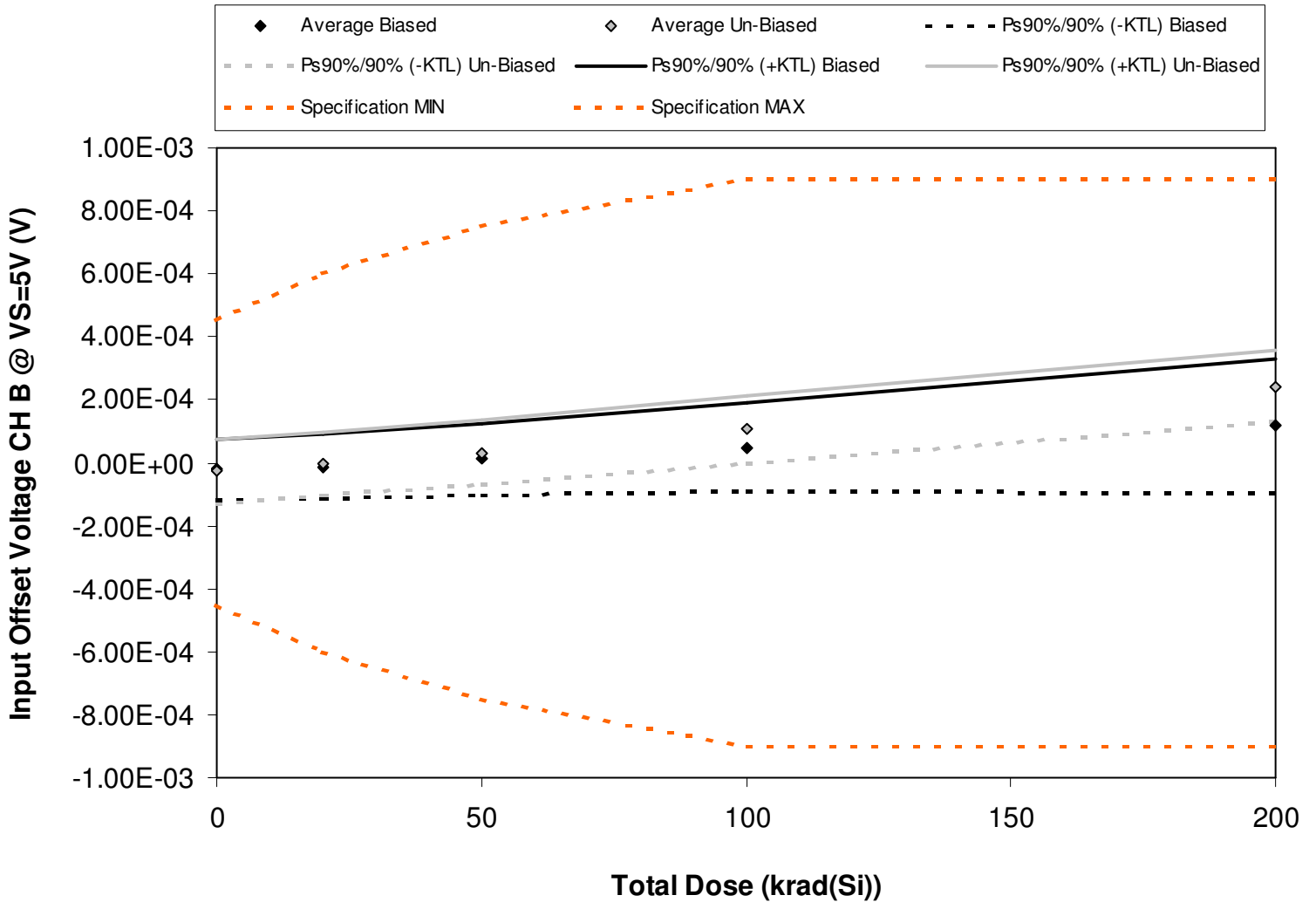

Figure 5.28. Plot of input offset voltage at 5V for channel B versus total dose. The data show a slight increase with total dose, however not sufficient for the parameter to exceed specification, including after application of the KTL statistics. The solid diamonds are the average of measured data points from the biased sample (devices irradiated with an electrical bias) while the shaded diamonds are the average from the un-biased sample. The black line(s) show the effects on the data after application of the biased KTL statistics (solid and/or dashed lines) while the gray line(s) show the effects on the data after application of the unbiased KTL statistics (solid and/or dashed lines). The red dashed line(s) are the minimum and/or maximum specification values as defined in the datasheet and/or test plan.



Table 5.28. Raw data of the input offset voltage at 5V for channel B versus total dose, including the statistical analysis, the specification and the status of the testing (pass/fail).

Input Offset Voltage CH B @ VS=5V (V)	Total Dose (krad(Si))				
	0	20	50	100	200
Device					
1090	2.49E-05	3.51E-05	6.54E-05	1.12E-04	1.99E-04
1092	-1.92E-05	-8.09E-06	8.45E-06	3.75E-05	9.01E-05
1093	-3.71E-05	-3.44E-05	-2.05E-05	1.01E-05	4.83E-05
1094	-4.35E-06	7.12E-06	4.09E-05	9.40E-05	2.04E-04
1095	-6.98E-05	-6.24E-05	-3.65E-05	-7.85E-06	4.91E-05
1096	9.42E-06	2.97E-05	6.75E-05	1.41E-04	2.63E-04
1097	3.74E-06	3.34E-05	7.30E-05	1.57E-04	3.01E-04
1098	-2.04E-05	-3.98E-06	2.75E-05	9.15E-05	1.93E-04
1099	-5.34E-05	-2.72E-05	7.97E-06	8.03E-05	2.26E-04
1100	-7.62E-05	-5.24E-05	-1.33E-05	6.60E-05	2.29E-04
1106	1.15E-05	1.07E-05	1.07E-05	1.06E-05	1.17E-05
1113	-2.52E-05	-2.51E-05	-2.54E-05	-2.58E-05	-2.47E-05
Biased Statistics					
Average Biased	-2.11E-05	-1.25E-05	1.16E-05	4.92E-05	1.18E-04
Std Dev Biased	3.54E-05	3.76E-05	4.22E-05	5.22E-05	7.80E-05
Ps90%/90% (+KTL) Biased	7.61E-05	9.05E-05	1.27E-04	1.92E-04	3.32E-04
Ps90%/90% (-KTL) Biased	-1.18E-04	-1.16E-04	-1.04E-04	-9.39E-05	-9.59E-05
Un-Biased Statistics					
Average Un-Biased	-2.74E-05	-4.08E-06	3.25E-05	1.07E-04	2.42E-04
Std Dev Un-Biased	3.68E-05	3.68E-05	3.74E-05	3.95E-05	4.11E-05
Ps90%/90% (+KTL) Un-Biased	7.37E-05	9.68E-05	1.35E-04	2.15E-04	3.55E-04
Ps90%/90% (-KTL) Un-Biased	-1.28E-04	-1.05E-04	-7.00E-05	-1.25E-06	1.30E-04
Specification MIN	-4.50E-04	-6.00E-04	-7.50E-04	-9.00E-04	-9.00E-04
Status	PASS	PASS	PASS	PASS	PASS
Specification MAX	4.50E-04	6.00E-04	7.50E-04	9.00E-04	9.00E-04
Status	PASS	PASS	PASS	PASS	PASS

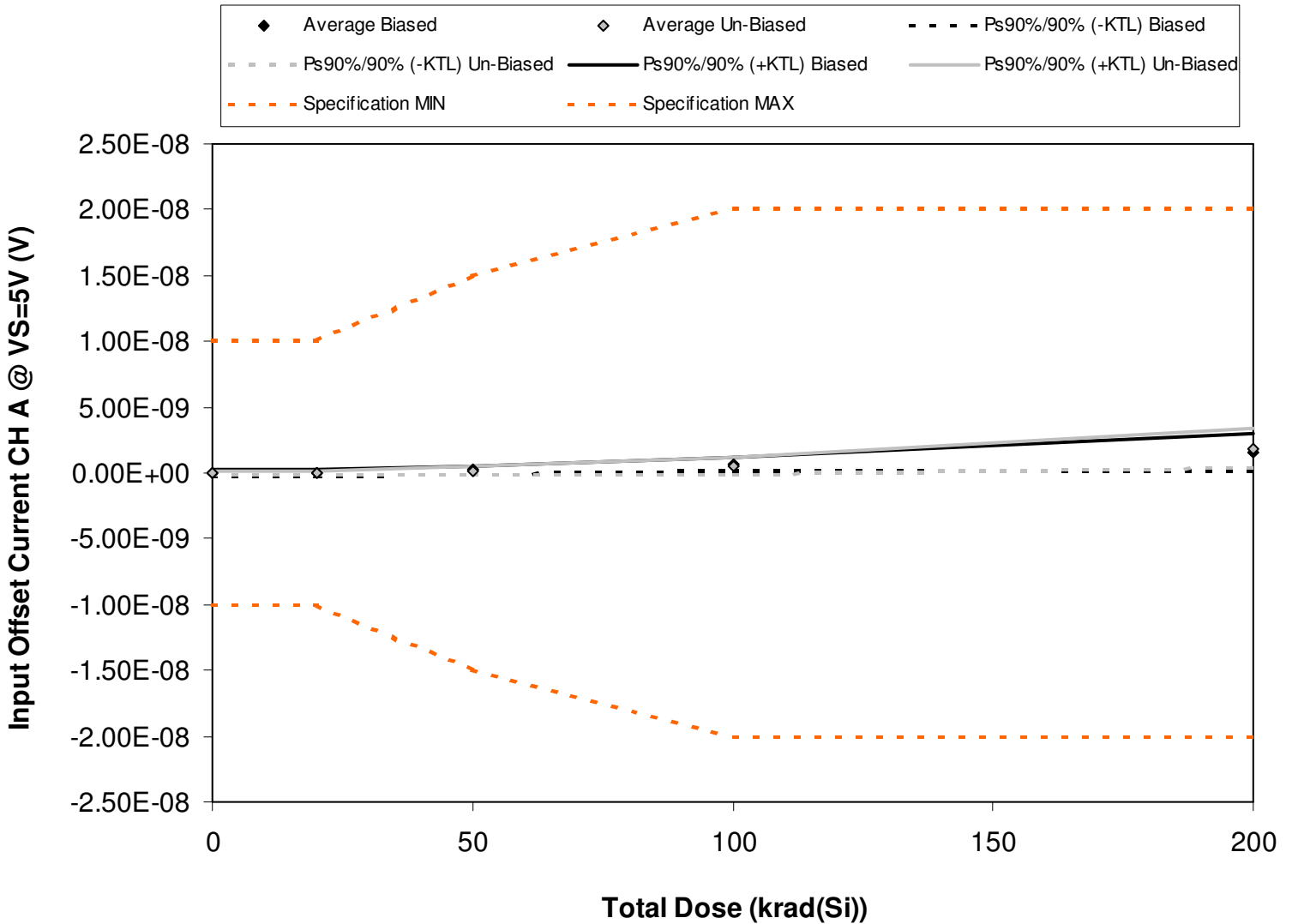

Figure 5.29. Plot of input offset current at 5V for channel A versus total dose. The data show a very slight increase with total dose, however not sufficient for the parameter to exceed specification, including after application of the KTL statistics. The solid diamonds are the average of measured data points from the biased sample (devices irradiated with an electrical bias) while the shaded diamonds are the average from the un-biased sample. The black line(s) show the effects on the data after application of the biased KTL statistics (solid and/or dashed lines) while the gray line(s) show the effects on the data after application of the unbiased KTL statistics (solid and/or dashed lines). The red dashed line(s) are the minimum and/or maximum specification values as defined in the datasheet and/or test plan.



Table 5.29. Raw data of input offset current at 5V for channel A versus total dose, including the statistical analysis, the specification and the status of the testing (pass/fail).

Input Offset Current CH A @ VS=5V (V)	Total Dose (krad(Si))				
	0	20	50	100	200
Device					
1090	7.50E-11	1.60E-10	1.47E-10	6.62E-10	1.20E-09
1092	-6.70E-11	-6.30E-11	1.18E-10	4.24E-10	1.23E-09
1093	-5.90E-11	6.10E-11	2.01E-10	6.03E-10	2.05E-09
1094	-1.07E-10	-3.50E-11	3.98E-10	9.01E-10	2.22E-09
1095	7.50E-11	5.10E-11	2.22E-10	6.15E-10	1.12E-09
1096	1.00E-11	3.60E-11	2.80E-10	8.99E-10	2.47E-09
1097	3.60E-11	6.40E-11	1.32E-10	4.04E-10	1.53E-09
1098	-3.70E-11	0.00E+00	2.50E-11	3.17E-10	1.47E-09
1099	-7.80E-11	-4.40E-11	1.25E-10	6.30E-10	2.49E-09
1100	1.00E-11	6.60E-11	2.74E-10	5.00E-10	1.40E-09
1106	-2.00E-11	-1.21E-10	-8.00E-12	-1.13E-10	-1.21E-10
1113	-1.90E-11	0.00E+00	2.40E-11	-1.00E-11	-2.40E-11
Biased Statistics					
Average Biased	-1.66E-11	3.48E-11	2.17E-10	6.41E-10	1.56E-09
Std Dev Biased	8.56E-11	8.81E-11	1.09E-10	1.71E-10	5.27E-10
Ps90%/90% (+KTL) Biased	2.18E-10	2.76E-10	5.17E-10	1.11E-09	3.01E-09
Ps90%/90% (-KTL) Biased	-2.51E-10	-2.07E-10	-8.24E-11	1.72E-10	1.17E-10
Un-Biased Statistics					
Average Un-Biased	-1.18E-11	2.44E-11	1.67E-10	5.50E-10	1.87E-09
Std Dev Un-Biased	4.54E-11	4.67E-11	1.09E-10	2.27E-10	5.58E-10
Ps90%/90% (+KTL) Un-Biased	1.13E-10	1.52E-10	4.66E-10	1.17E-09	3.40E-09
Ps90%/90% (-KTL) Un-Biased	-1.36E-10	-1.04E-10	-1.31E-10	-7.27E-11	3.43E-10
Specification MIN	-1.00E-08	-1.00E-08	-1.50E-08	-2.00E-08	-2.00E-08
Status	PASS	PASS	PASS	PASS	PASS
Specification MAX	1.00E-08	1.00E-08	1.50E-08	2.00E-08	2.00E-08
Status	PASS	PASS	PASS	PASS	PASS

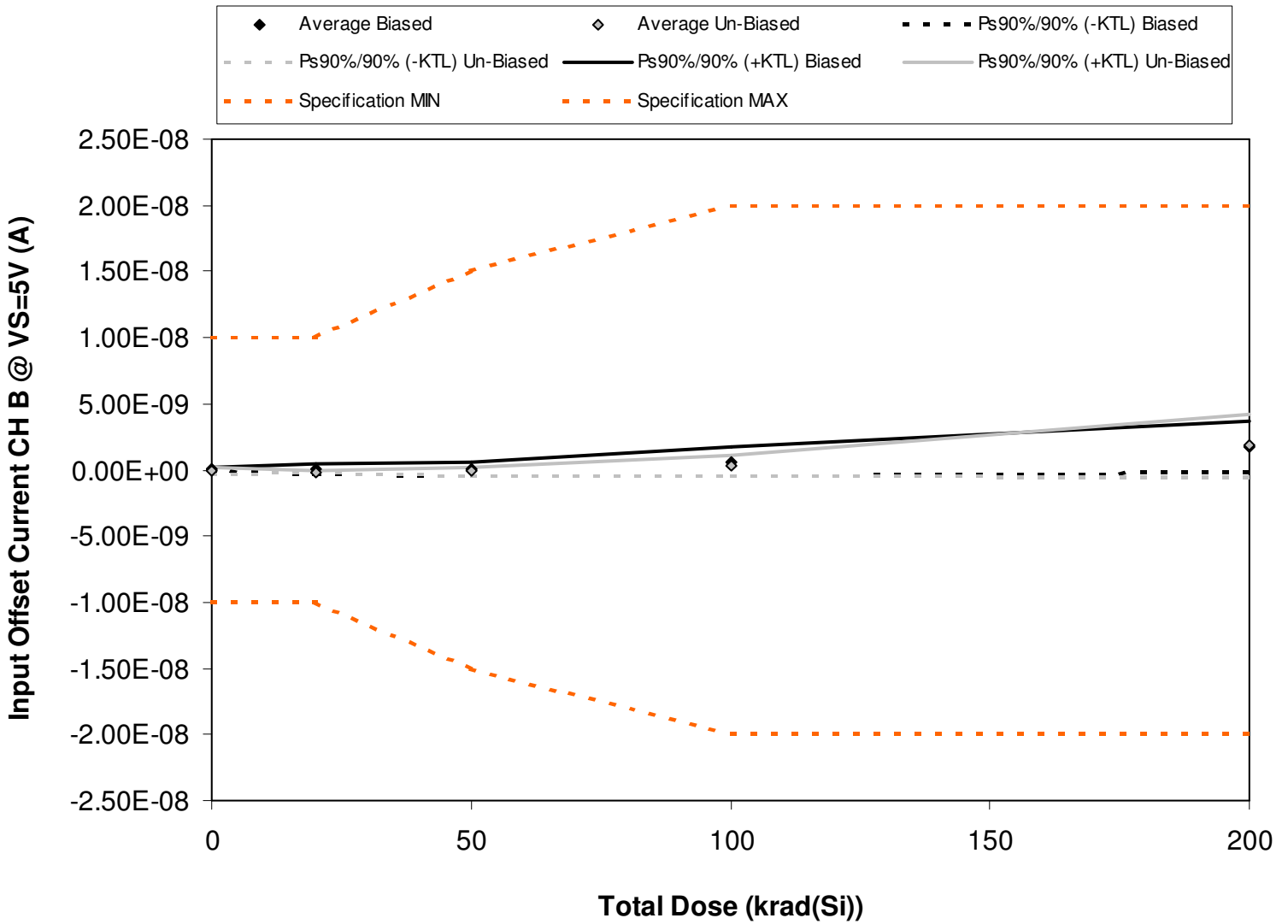

Figure 5.30. Plot of input offset current at 5V for channel B versus total dose. The data show a very slight increase with total dose, however not sufficient for the parameter to exceed specification, including after application of the KTL statistics. The solid diamonds are the average of measured data points from the biased sample (devices irradiated with an electrical bias) while the shaded diamonds are the average from the un-biased sample. The black line(s) show the effects on the data after application of the biased KTL statistics (solid and/or dashed lines) while the gray line(s) show the effects on the data after application of the unbiased KTL statistics (solid and/or dashed lines). The red dashed line(s) are the minimum and/or maximum specification values as defined in the datasheet and/or test plan.



Table 5.30. Raw data of input offset current at 5V for channel B versus total dose, including the statistical analysis, the specification and the status of the testing (pass/fail).

Input Offset Current CH B @ VS=5V (A)	Total Dose (krad(Si))				
	0	20	50	100	200
Device					
1090	6.00E-12	1.10E-11	-9.10E-11	4.08E-10	1.25E-09
1092	7.00E-12	-1.10E-10	-1.05E-10	2.23E-10	1.06E-09
1093	9.90E-11	2.46E-10	4.03E-10	1.09E-09	2.58E-09
1094	3.80E-11	-1.50E-11	1.01E-10	1.01E-09	2.48E-09
1095	5.10E-11	4.50E-11	2.80E-11	4.44E-10	1.54E-09
1096	1.80E-11	-1.34E-10	1.22E-10	7.53E-10	2.87E-09
1097	-1.65E-10	-1.74E-10	-1.46E-10	2.92E-10	1.99E-09
1098	-6.60E-11	-1.70E-10	-1.94E-10	9.80E-11	1.42E-09
1099	-1.14E-10	-1.22E-10	-6.80E-11	4.71E-10	2.21E-09
1100	6.00E-12	-1.72E-10	-1.43E-10	6.00E-11	5.98E-10
1106	-2.30E-11	-1.03E-10	1.60E-11	-1.30E-10	-1.08E-10
1113	3.90E-11	1.07E-10	7.80E-11	3.90E-11	-1.00E-11
Biased Statistics					
Average Biased	4.02E-11	3.54E-11	6.72E-11	6.35E-10	1.78E-09
Std Dev Biased	3.82E-11	1.31E-10	2.06E-10	3.89E-10	7.05E-10
Ps90%/90% (+KTL) Biased	1.45E-10	3.95E-10	6.33E-10	1.70E-09	3.71E-09
Ps90%/90% (-KTL) Biased	-6.47E-11	-3.24E-10	-4.98E-10	-4.32E-10	-1.54E-10
Un-Biased Statistics					
Average Un-Biased	-6.42E-11	-1.54E-10	-8.58E-11	3.35E-10	1.82E-09
Std Dev Un-Biased	7.80E-11	2.45E-11	1.25E-10	2.86E-10	8.58E-10
Ps90%/90% (+KTL) Un-Biased	1.50E-10	-8.72E-11	2.56E-10	1.12E-09	4.17E-09
Ps90%/90% (-KTL) Un-Biased	-2.78E-10	-2.22E-10	-4.27E-10	-4.49E-10	-5.35E-10
Specification MIN	-1.00E-08	-1.00E-08	-1.50E-08	-2.00E-08	-2.00E-08
Status	PASS	PASS	PASS	PASS	PASS
Specification MAX	1.00E-08	1.00E-08	1.50E-08	2.00E-08	2.00E-08
Status	PASS	PASS	PASS	PASS	PASS

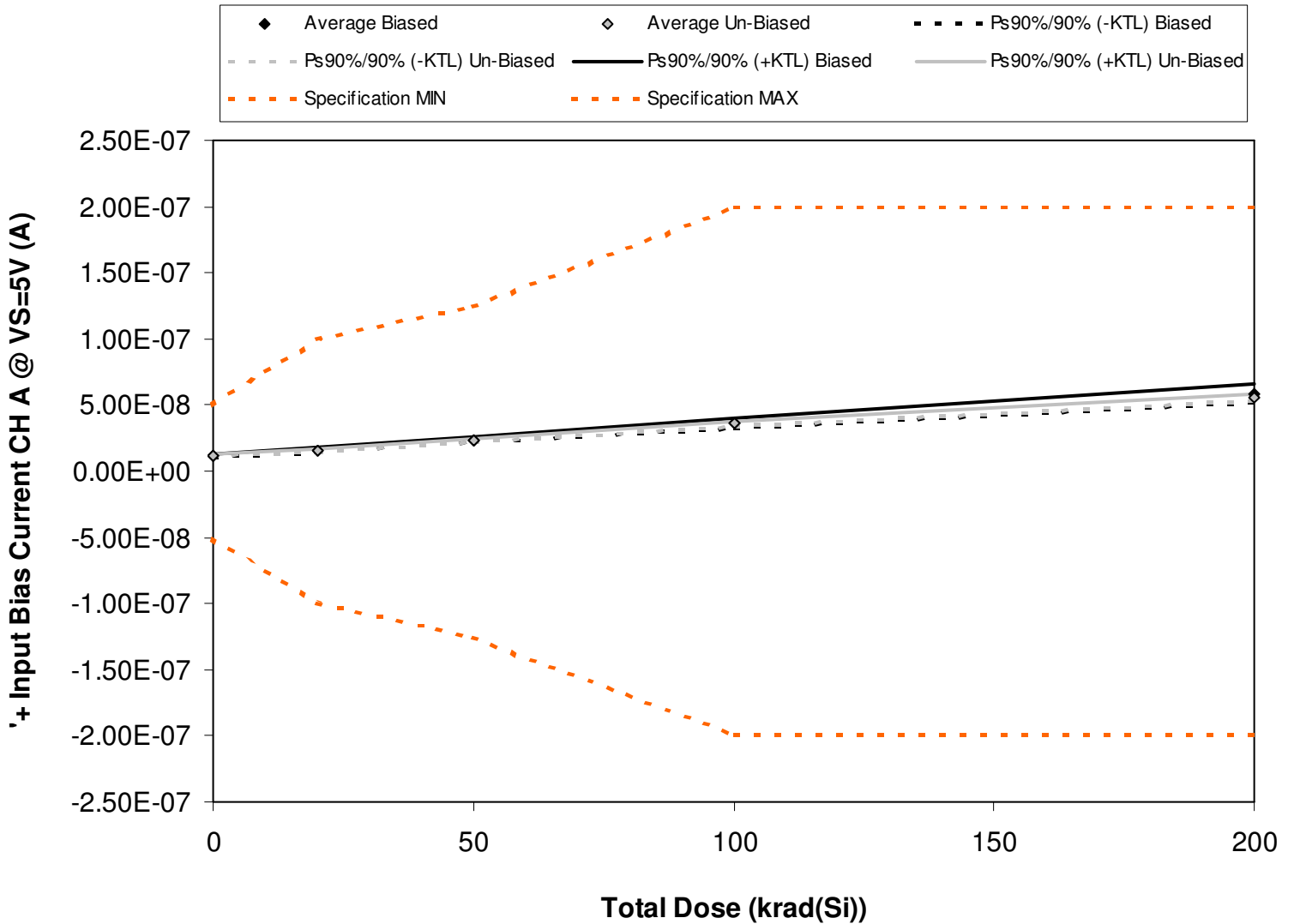

Figure 5.31. Plot of input bias current, non-inverting input at 5V for channel A versus total dose. The data show an increase with total dose, however not sufficient for the parameter to exceed specification, including after application of the KTL statistics. The solid diamonds are the average of measured data points from the biased sample (devices irradiated with an electrical bias) while the shaded diamonds are the average from the un-biased sample. The black line(s) show the effects on the data after application of the biased KTL statistics (solid and/or dashed lines) while the gray line(s) show the effects on the data after application of the unbiased KTL statistics (solid and/or dashed lines). The red dashed line(s) are the minimum and/or maximum specification values as defined in the datasheet and/or test plan.



Table 5.31. Raw data of input bias current, non-inverting input at 5V for channel A versus total dose, including the statistical analysis, the specification and the status of the testing (pass/fail).

+ Input Bias Current CH A @ VS=5V (A)	Total Dose (krad(Si))				
	0	20	50	100	200
Device					
1090	1.16E-08	1.57E-08	2.39E-08	3.67E-08	5.89E-08
1092	1.16E-08	1.58E-08	2.38E-08	3.66E-08	5.98E-08
1093	1.11E-08	1.50E-08	2.26E-08	3.43E-08	5.48E-08
1094	1.24E-08	1.67E-08	2.49E-08	3.80E-08	6.08E-08
1095	1.20E-08	1.62E-08	2.43E-08	3.73E-08	6.02E-08
1096	1.18E-08	1.56E-08	2.28E-08	3.44E-08	5.44E-08
1097	1.23E-08	1.65E-08	2.39E-08	3.59E-08	5.63E-08
1098	1.20E-08	1.62E-08	2.38E-08	3.62E-08	5.66E-08
1099	1.23E-08	1.63E-08	2.40E-08	3.64E-08	5.65E-08
1100	1.15E-08	1.54E-08	2.30E-08	3.52E-08	5.58E-08
1106	1.18E-08	1.18E-08	1.18E-08	1.17E-08	1.18E-08
1113	1.21E-08	1.21E-08	1.21E-08	1.21E-08	1.21E-08
Biased Statistics					
Average Biased	1.17E-08	1.59E-08	2.39E-08	3.66E-08	5.89E-08
Std Dev Biased	4.98E-10	6.25E-10	8.53E-10	1.41E-09	2.38E-09
Ps90%/90% (+KTL) Biased	1.31E-08	1.76E-08	2.62E-08	4.04E-08	6.54E-08
Ps90%/90% (-KTL) Biased	1.04E-08	1.42E-08	2.16E-08	3.27E-08	5.24E-08
Un-Biased Statistics					
Average Un-Biased	1.20E-08	1.60E-08	2.35E-08	3.56E-08	5.59E-08
Std Dev Un-Biased	3.49E-10	4.50E-10	5.60E-10	8.20E-10	8.89E-10
Ps90%/90% (+KTL) Un-Biased	1.29E-08	1.72E-08	2.50E-08	3.79E-08	5.83E-08
Ps90%/90% (-KTL) Un-Biased	1.10E-08	1.48E-08	2.20E-08	3.34E-08	5.35E-08
Specification MIN	-5.00E-08	-1.00E-07	-1.25E-07	-2.00E-07	-2.00E-07
Status	PASS	PASS	PASS	PASS	PASS
Specification MAX	5.00E-08	1.00E-07	1.25E-07	2.00E-07	2.00E-07
Status	PASS	PASS	PASS	PASS	PASS

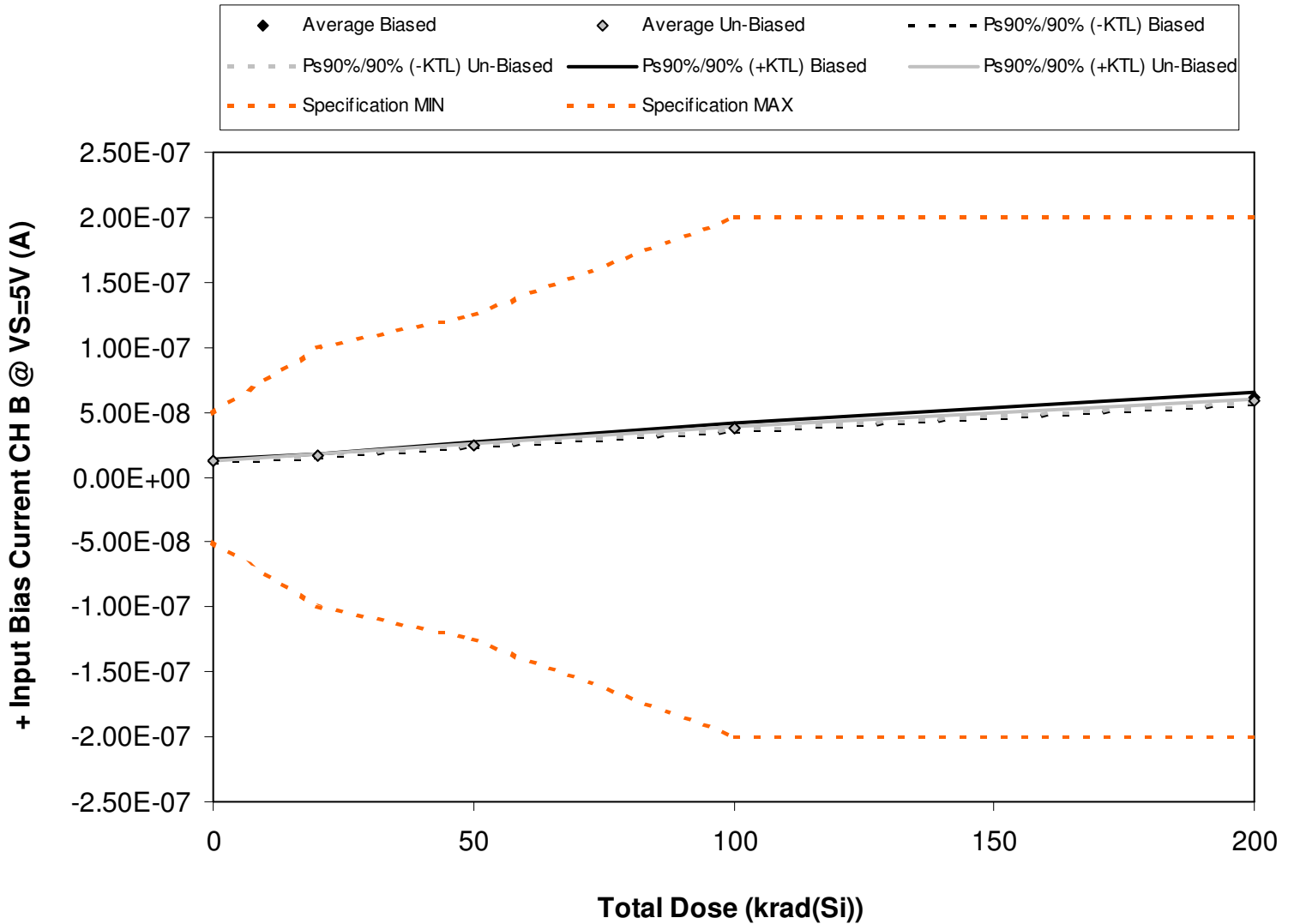

Figure 5.32. Plot of input bias current, non-inverting input at 5V for channel B versus total dose. The data show a slight increase with total dose, however not sufficient for the parameter to exceed specification, including after application of the KTL statistics. The solid diamonds are the average of measured data points from the biased sample (devices irradiated with an electrical bias) while the shaded diamonds are the average from the un-biased sample. The black line(s) show the effects on the data after application of the biased KTL statistics (solid and/or dashed lines) while the gray line(s) show the effects on the data after application of the unbiased KTL statistics (solid and/or dashed lines). The red dashed line(s) are the minimum and/or maximum specification values as defined in the datasheet and/or test plan.



Table 5.32. Raw data of input bias current, non-inverting input at 5V for channel B versus total dose, including the statistical analysis, the specification and the status of the testing (pass/fail).

+ Input Bias Current CH B @ VS=5V (A)	Total Dose (krad(Si))				
	0	20	50	100	200
Device					
1090	1.20E-08	1.62E-08	2.47E-08	3.77E-08	6.02E-08
1092	1.20E-08	1.64E-08	2.48E-08	3.82E-08	6.18E-08
1093	1.21E-08	1.63E-08	2.44E-08	3.68E-08	5.84E-08
1094	1.29E-08	1.74E-08	2.59E-08	3.93E-08	6.25E-08
1095	1.26E-08	1.70E-08	2.55E-08	3.90E-08	6.24E-08
1096	1.27E-08	1.70E-08	2.48E-08	3.71E-08	5.83E-08
1097	1.29E-08	1.72E-08	2.49E-08	3.73E-08	5.82E-08
1098	1.24E-08	1.68E-08	2.47E-08	3.75E-08	5.83E-08
1099	1.28E-08	1.69E-08	2.50E-08	3.78E-08	5.86E-08
1100	1.26E-08	1.69E-08	2.50E-08	3.79E-08	5.94E-08
1106	1.23E-08	1.22E-08	1.23E-08	1.22E-08	1.22E-08
1113	1.20E-08	1.19E-08	1.20E-08	1.19E-08	1.19E-08
Biased Statistics					
Average Biased	1.23E-08	1.66E-08	2.51E-08	3.82E-08	6.11E-08
Std Dev Biased	4.13E-10	5.22E-10	6.39E-10	1.01E-09	1.72E-09
Ps90%/90% (+KTL) Biased	1.35E-08	1.81E-08	2.68E-08	4.10E-08	6.58E-08
Ps90%/90% (-KTL) Biased	1.12E-08	1.52E-08	2.33E-08	3.55E-08	5.63E-08
Un-Biased Statistics					
Average Un-Biased	1.27E-08	1.70E-08	2.49E-08	3.75E-08	5.86E-08
Std Dev Un-Biased	1.88E-10	1.60E-10	1.15E-10	3.29E-10	4.98E-10
Ps90%/90% (+KTL) Un-Biased	1.32E-08	1.74E-08	2.52E-08	3.84E-08	5.99E-08
Ps90%/90% (-KTL) Un-Biased	1.22E-08	1.65E-08	2.46E-08	3.66E-08	5.72E-08
Specification MIN	-5.00E-08	-1.00E-07	-1.25E-07	-2.00E-07	-2.00E-07
Status	PASS	PASS	PASS	PASS	PASS
Specification MAX	5.00E-08	1.00E-07	1.25E-07	2.00E-07	2.00E-07
Status	PASS	PASS	PASS	PASS	PASS

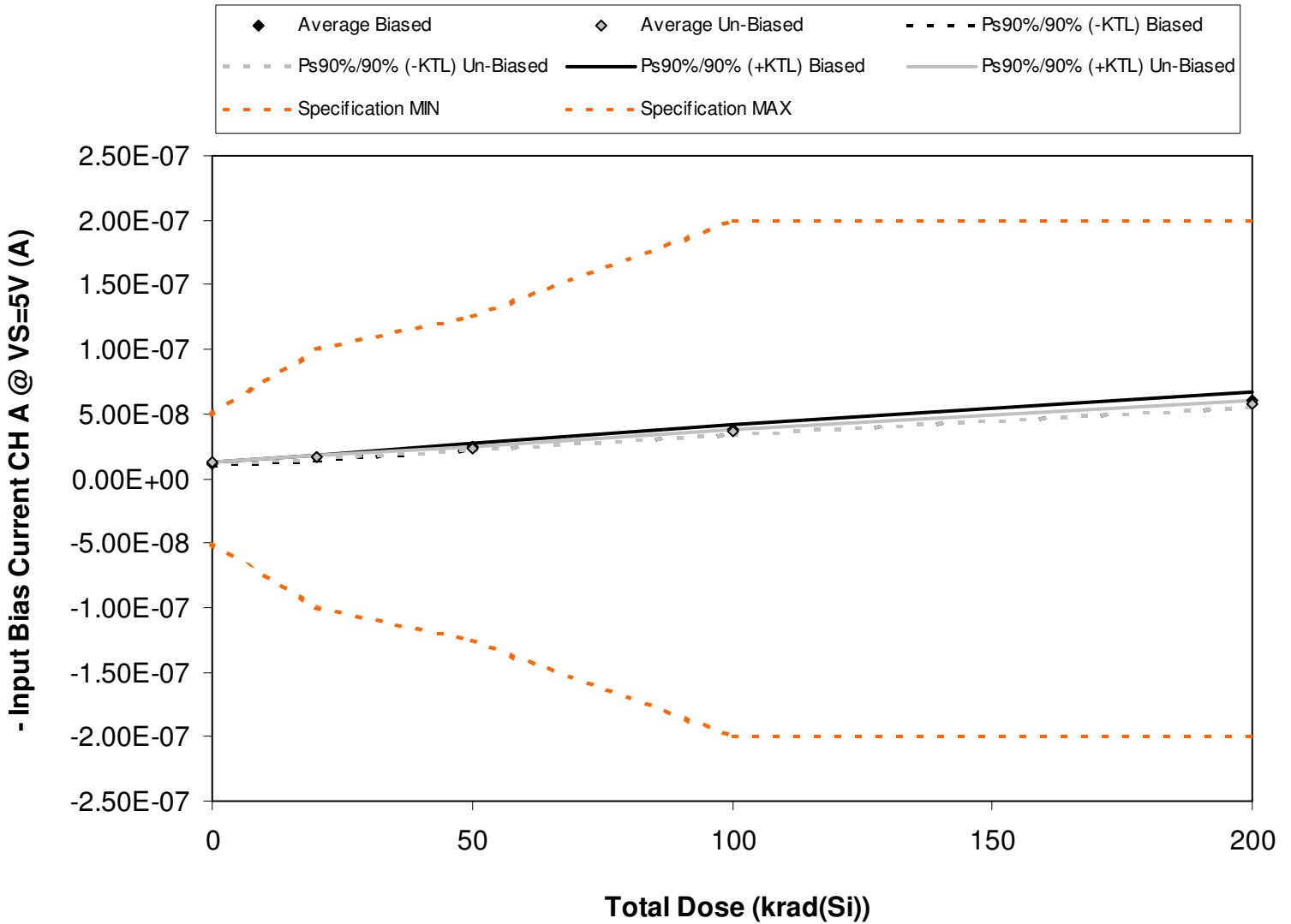

Figure 5.33. Plot of input bias current, inverting input at 5V for channel A versus total dose. The data show a slight increase with total dose, however not sufficient for the parameter to exceed specification, including after application of the KTL statistics. The solid diamonds are the average of measured data points from the biased sample (devices irradiated with an electrical bias) while the shaded diamonds are the average from the un-biased sample. The black line(s) show the effects on the data after application of the biased KTL statistics (solid and/or dashed lines) while the gray line(s) show the effects on the data after application of the unbiased KTL statistics (solid and/or dashed lines). The red dashed line(s) are the minimum and/or maximum specification values as defined in the datasheet and/or test plan.



Table 5.33. Raw data of the input bias current, inverting input at 5V for channel A versus total dose, including the statistical analysis, the specification and the status of the testing (pass/fail).

- Input Bias Current CH A @ VS=5V (A)	Total Dose (krad(Si))				
	0	20	50	100	200
Device					
1090	1.16E-08	1.59E-08	2.43E-08	3.74E-08	6.04E-08
1092	1.17E-08	1.59E-08	2.40E-08	3.73E-08	6.12E-08
1093	1.12E-08	1.52E-08	2.29E-08	3.50E-08	5.70E-08
1094	1.25E-08	1.68E-08	2.54E-08	3.90E-08	6.32E-08
1095	1.21E-08	1.64E-08	2.46E-08	3.82E-08	6.16E-08
1096	1.17E-08	1.57E-08	2.32E-08	3.54E-08	5.70E-08
1097	1.25E-08	1.67E-08	2.41E-08	3.65E-08	5.80E-08
1098	1.21E-08	1.62E-08	2.40E-08	3.68E-08	5.81E-08
1099	1.22E-08	1.63E-08	2.43E-08	3.73E-08	5.91E-08
1100	1.15E-08	1.56E-08	2.33E-08	3.58E-08	5.73E-08
1106	1.18E-08	1.19E-08	1.18E-08	1.17E-08	1.17E-08
1113	1.24E-08	1.23E-08	1.23E-08	1.22E-08	1.21E-08
Biased Statistics					
Average Biased	1.18E-08	1.60E-08	2.42E-08	3.74E-08	6.07E-08
Std Dev Biased	4.90E-10	6.13E-10	9.04E-10	1.49E-09	2.28E-09
Ps90%/90% (+KTL) Biased	1.32E-08	1.77E-08	2.67E-08	4.15E-08	6.69E-08
Ps90%/90% (-KTL) Biased	1.05E-08	1.44E-08	2.17E-08	3.33E-08	5.44E-08
Un-Biased Statistics					
Average Un-Biased	1.20E-08	1.61E-08	2.38E-08	3.64E-08	5.79E-08
Std Dev Un-Biased	4.03E-10	4.59E-10	5.04E-10	7.62E-10	8.19E-10
Ps90%/90% (+KTL) Un-Biased	1.31E-08	1.74E-08	2.51E-08	3.85E-08	6.01E-08
Ps90%/90% (-KTL) Un-Biased	1.09E-08	1.48E-08	2.24E-08	3.43E-08	5.57E-08
Specification MIN	-5.00E-08	-1.00E-07	-1.25E-07	-2.00E-07	-2.00E-07
Status	PASS	PASS	PASS	PASS	PASS
Specification MAX	5.00E-08	1.00E-07	1.25E-07	2.00E-07	2.00E-07
Status	PASS	PASS	PASS	PASS	PASS

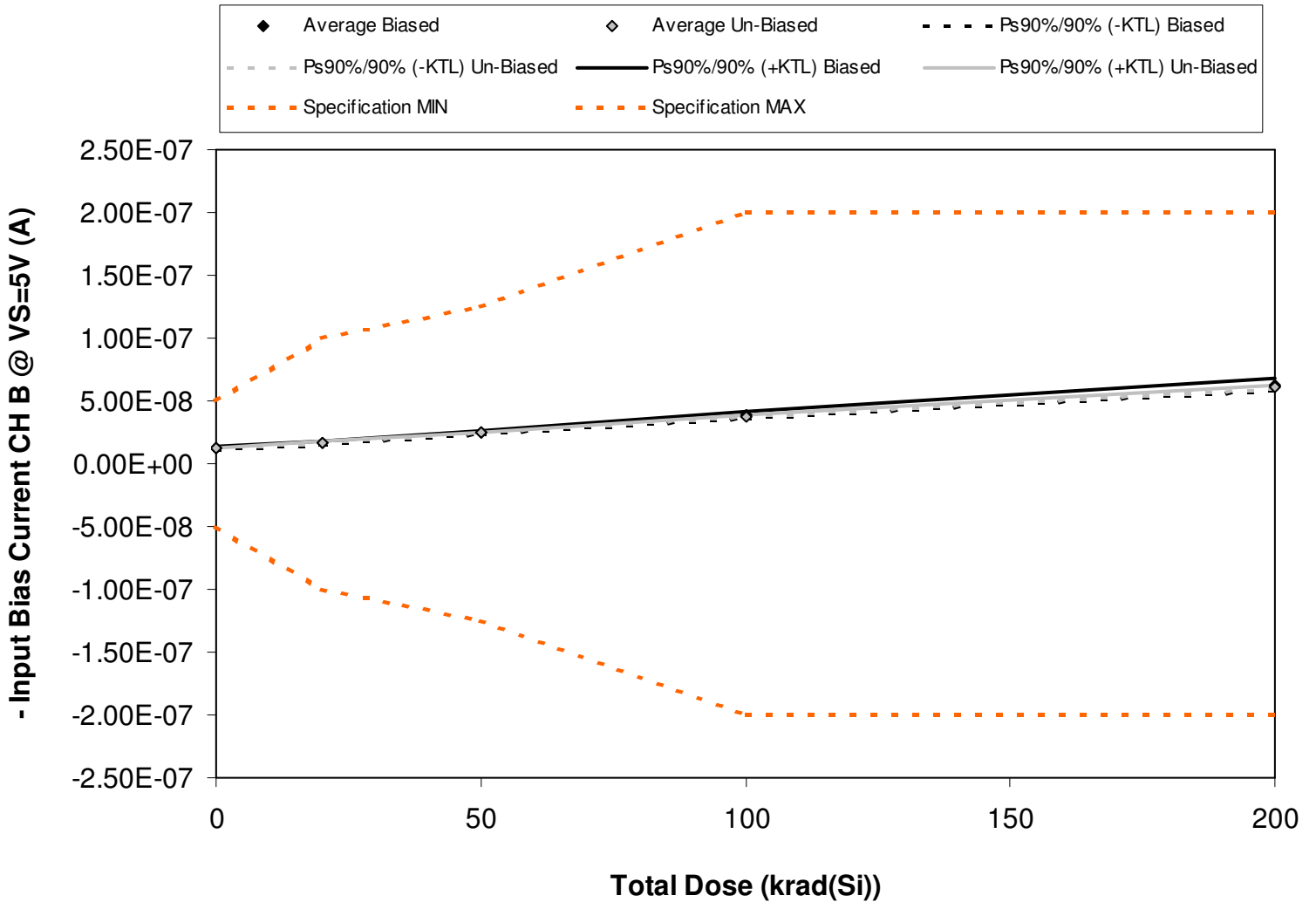

Figure 5.34. Plot of input bias current, inverting input at 5V for channel B versus total dose. The data show a slight increase with total dose, however not sufficient for the parameter to exceed specification, including after application of the KTL statistics. The solid diamonds are the average of measured data points from the biased sample (devices irradiated with an electrical bias) while the shaded diamonds are the average from the un-biased sample. The black line(s) show the effects on the data after application of the biased KTL statistics (solid and/or dashed lines) while the gray line(s) show the effects on the data after application of the unbiased KTL statistics (solid and/or dashed lines). The red dashed line(s) are the minimum and/or maximum specification values as defined in the datasheet and/or test plan.



Table 5.34. Raw data of the input bias current, inverting input at 5V for channel B versus total dose, including the statistical analysis, the specification and the status of the testing (pass/fail).

- Input Bias Current CH B @ VS=5V (A)	Total Dose (krad(Si))				
	0	20	50	100	200
Device					
1090	1.20E-08	1.63E-08	2.47E-08	3.82E-08	6.17E-08
1092	1.21E-08	1.64E-08	2.48E-08	3.86E-08	6.30E-08
1093	1.23E-08	1.66E-08	2.49E-08	3.81E-08	6.13E-08
1094	1.30E-08	1.75E-08	2.62E-08	4.04E-08	6.53E-08
1095	1.26E-08	1.71E-08	2.56E-08	3.97E-08	6.41E-08
1096	1.27E-08	1.70E-08	2.50E-08	3.80E-08	6.11E-08
1097	1.29E-08	1.72E-08	2.50E-08	3.77E-08	6.04E-08
1098	1.25E-08	1.66E-08	2.45E-08	3.78E-08	5.98E-08
1099	1.27E-08	1.70E-08	2.50E-08	3.85E-08	6.10E-08
1100	1.26E-08	1.69E-08	2.48E-08	3.82E-08	6.03E-08
1106	1.23E-08	1.23E-08	1.22E-08	1.23E-08	1.23E-08
1113	1.21E-08	1.21E-08	1.21E-08	1.21E-08	1.20E-08
Biased Statistics					
Average Biased	1.24E-08	1.68E-08	2.52E-08	3.90E-08	6.31E-08
Std Dev Biased	4.15E-10	5.14E-10	6.29E-10	1.02E-09	1.66E-09
Ps90%/90% (+KTL) Biased	1.36E-08	1.82E-08	2.70E-08	4.18E-08	6.76E-08
Ps90%/90% (-KTL) Biased	1.13E-08	1.54E-08	2.35E-08	3.62E-08	5.85E-08
Un-Biased Statistics					
Average Un-Biased	1.27E-08	1.69E-08	2.48E-08	3.80E-08	6.05E-08
Std Dev Un-Biased	1.39E-10	2.08E-10	1.87E-10	2.95E-10	5.35E-10
Ps90%/90% (+KTL) Un-Biased	1.31E-08	1.75E-08	2.54E-08	3.88E-08	6.20E-08
Ps90%/90% (-KTL) Un-Biased	1.23E-08	1.64E-08	2.43E-08	3.72E-08	5.90E-08
Specification MIN	-5.00E-08	-1.00E-07	-1.25E-07	-2.00E-07	-2.00E-07
Status	PASS	PASS	PASS	PASS	PASS
Specification MAX	5.00E-08	1.00E-07	1.25E-07	2.00E-07	2.00E-07
Status	PASS	PASS	PASS	PASS	PASS

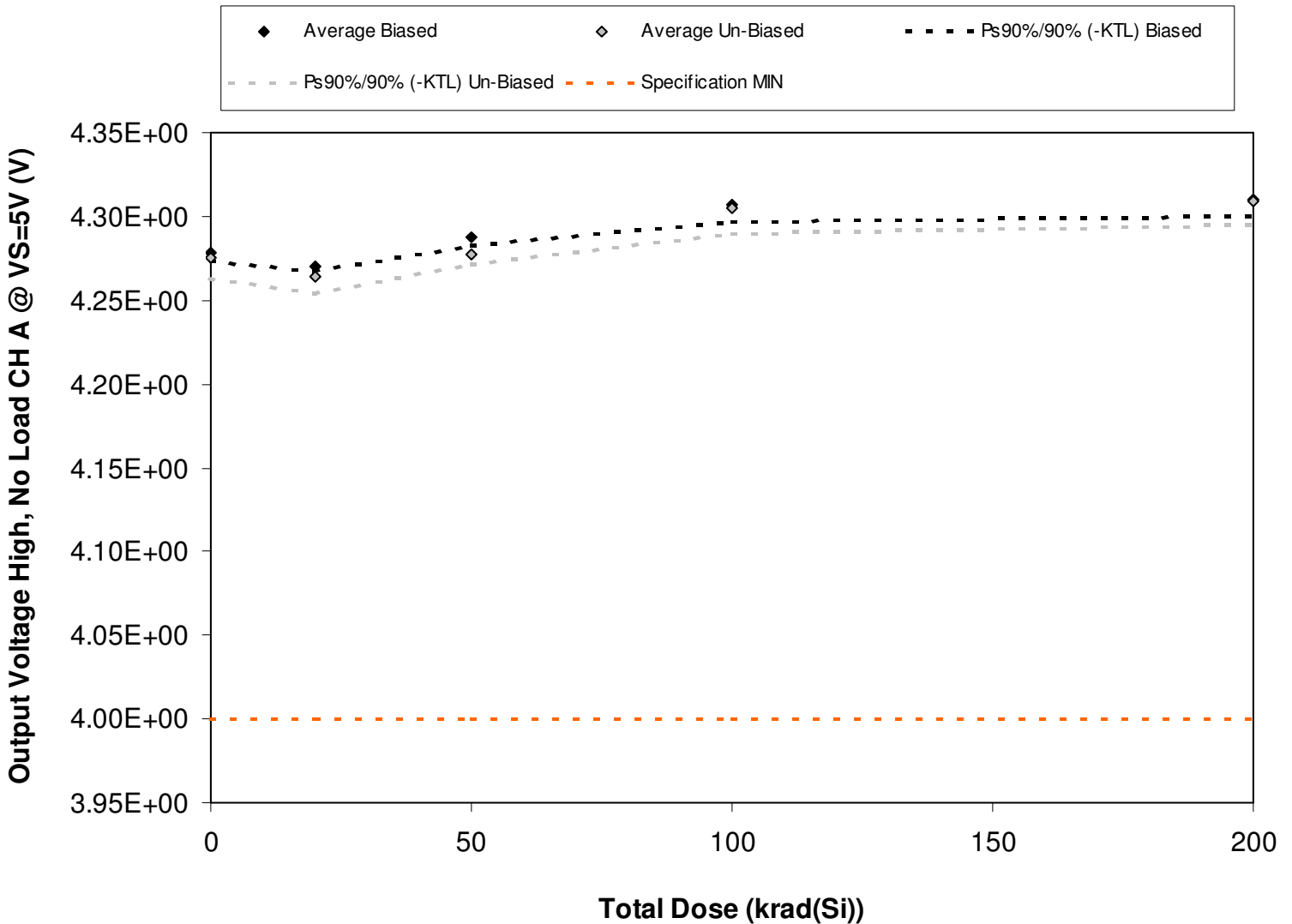

Figure 5.35. Plot of the output voltage high (no load) at 5V for channel A versus total dose. The data show only a slight change with total dose, however not sufficient for the parameter to fall below specification, including after application of the KTL statistics. The solid diamonds are the average of measured data points from the biased sample (devices irradiated with an electrical bias) while the shaded diamonds are the average from the un-biased sample. The black line(s) show the effects on the data after application of the biased KTL statistics (solid and/or dashed lines) while the gray line(s) show the effects on the data after application of the unbiased KTL statistics (solid and/or dashed lines). The red dashed line(s) are the minimum and/or maximum specification values as defined in the datasheet and/or test plan.



Table 5.35. Raw data of output voltage high (no load) at 5V for channel A versus total dose, including the statistical analysis, the specification and the status of the testing (pass/fail).

Output Voltage High, No Load CH A @ VS=5V (V)	Total Dose (krad(Si))				
	0	20	50	100	200
Device					
1090	4.28E+00	4.27E+00	4.29E+00	4.31E+00	4.31E+00
1092	4.28E+00	4.27E+00	4.29E+00	4.31E+00	4.31E+00
1093	4.28E+00	4.27E+00	4.29E+00	4.31E+00	4.31E+00
1094	4.28E+00	4.27E+00	4.29E+00	4.30E+00	4.31E+00
1095	4.28E+00	4.27E+00	4.29E+00	4.31E+00	4.31E+00
1096	4.28E+00	4.27E+00	4.28E+00	4.31E+00	4.31E+00
1097	4.28E+00	4.26E+00	4.28E+00	4.30E+00	4.30E+00
1098	4.28E+00	4.27E+00	4.28E+00	4.31E+00	4.32E+00
1099	4.27E+00	4.26E+00	4.28E+00	4.31E+00	4.31E+00
1100	4.27E+00	4.26E+00	4.28E+00	4.30E+00	4.31E+00
1106	4.28E+00	4.28E+00	4.28E+00	4.28E+00	4.28E+00
1113	4.27E+00	4.27E+00	4.27E+00	4.27E+00	4.27E+00
Biased Statistics					
Average Biased	4.28E+00	4.27E+00	4.29E+00	4.31E+00	4.31E+00
Std Dev Biased	1.87E-03	1.10E-03	1.79E-03	3.63E-03	3.91E-03
Ps90%/90% (+KTL) Biased	4.28E+00	4.27E+00	4.29E+00	4.32E+00	4.32E+00
Ps90%/90% (-KTL) Biased	4.27E+00	4.27E+00	4.28E+00	4.30E+00	4.30E+00
Un-Biased Statistics					
Average Un-Biased	4.28E+00	4.26E+00	4.28E+00	4.31E+00	4.31E+00
Std Dev Un-Biased	4.60E-03	3.70E-03	2.49E-03	5.63E-03	5.36E-03
Ps90%/90% (+KTL) Un-Biased	4.29E+00	4.27E+00	4.28E+00	4.32E+00	4.32E+00
Ps90%/90% (-KTL) Un-Biased	4.26E+00	4.25E+00	4.27E+00	4.29E+00	4.29E+00
Specification MIN	4.00E+00	4.00E+00	4.00E+00	4.00E+00	4.00E+00
Status	PASS	PASS	PASS	PASS	PASS

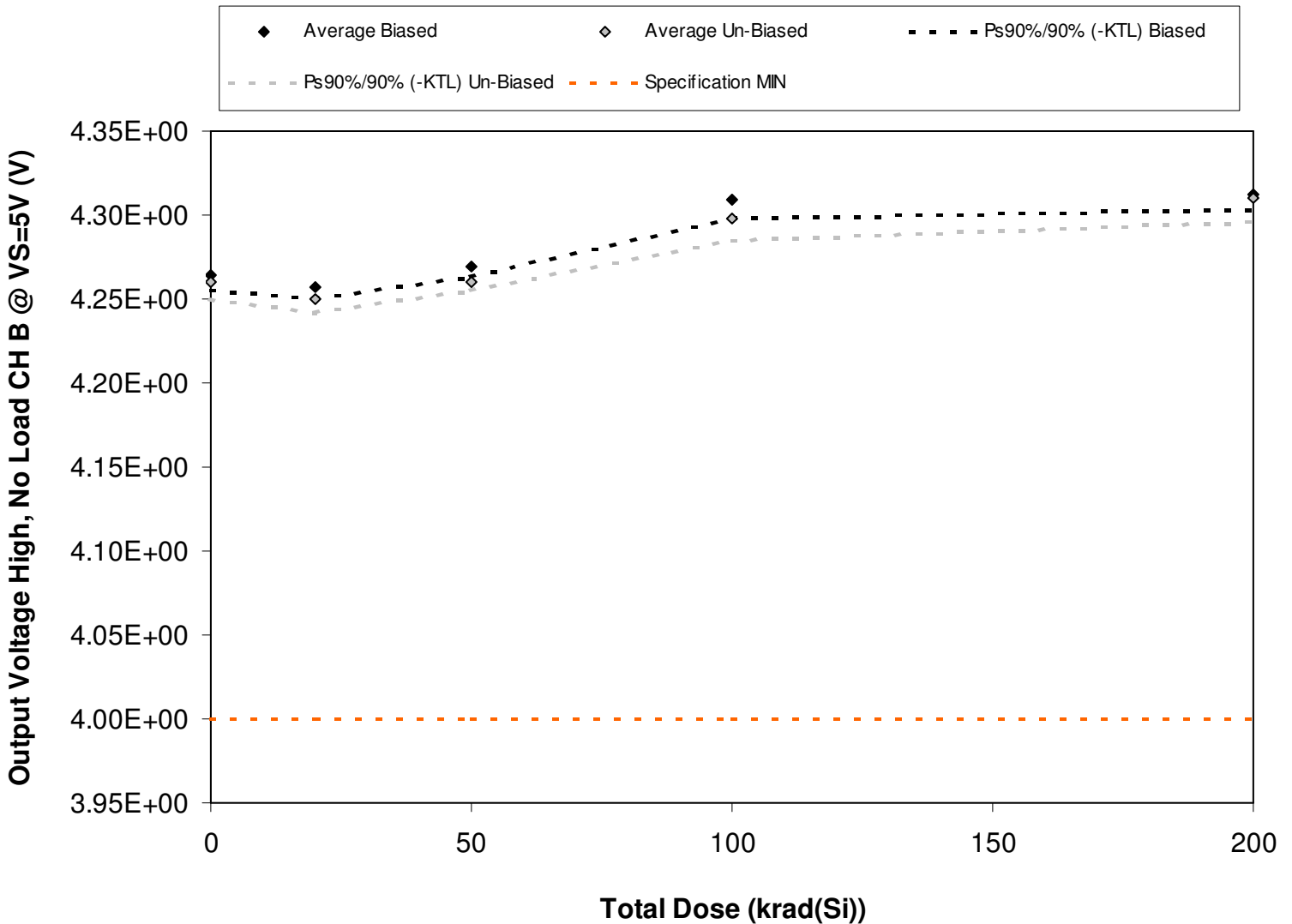

Figure 5.36. Plot of the output voltage high (no load) at 5V for channel B versus total dose. The data show only a slight change with total dose, however not sufficient for the parameter to fall below specification, including after application of the KTL statistics. The solid diamonds are the average of measured data points from the biased sample (devices irradiated with an electrical bias) while the shaded diamonds are the average from the un-biased sample. The black line(s) show the effects on the data after application of the biased KTL statistics (solid and/or dashed lines) while the gray line(s) show the effects on the data after application of the unbiased KTL statistics (solid and/or dashed lines). The red dashed line(s) are the minimum and/or maximum specification values as defined in the datasheet and/or test plan.



Table 5.36. Raw data of output voltage high (no load) at 5V for channel B versus total dose, including the statistical analysis, the specification and the status of the testing (pass/fail).

Output Voltage High, No Load CH B @ VS=5V (V)	Total Dose (krad(Si))				
	0	20	50	100	200
Device					
1090	4.27E+00	4.26E+00	4.27E+00	4.31E+00	4.31E+00
1092	4.26E+00	4.26E+00	4.27E+00	4.31E+00	4.32E+00
1093	4.27E+00	4.26E+00	4.27E+00	4.31E+00	4.31E+00
1094	4.26E+00	4.26E+00	4.27E+00	4.30E+00	4.31E+00
1095	4.26E+00	4.26E+00	4.27E+00	4.31E+00	4.31E+00
1096	4.26E+00	4.25E+00	4.26E+00	4.30E+00	4.31E+00
1097	4.26E+00	4.25E+00	4.26E+00	4.30E+00	4.31E+00
1098	4.27E+00	4.26E+00	4.26E+00	4.29E+00	4.32E+00
1099	4.26E+00	4.25E+00	4.26E+00	4.30E+00	4.31E+00
1100	4.26E+00	4.25E+00	4.26E+00	4.30E+00	4.31E+00
1106	4.27E+00	4.27E+00	4.27E+00	4.27E+00	4.27E+00
1113	4.26E+00	4.25E+00	4.25E+00	4.25E+00	4.25E+00
Biased Statistics					
Average Biased	4.26E+00	4.26E+00	4.27E+00	4.31E+00	4.31E+00
Std Dev Biased	3.44E-03	2.61E-03	2.30E-03	4.09E-03	3.39E-03
Ps90%/90% (+KTL) Biased	4.27E+00	4.26E+00	4.28E+00	4.32E+00	4.32E+00
Ps90%/90% (-KTL) Biased	4.25E+00	4.25E+00	4.26E+00	4.30E+00	4.30E+00
Un-Biased Statistics					
Average Un-Biased	4.26E+00	4.25E+00	4.26E+00	4.30E+00	4.31E+00
Std Dev Un-Biased	4.04E-03	3.13E-03	1.79E-03	4.69E-03	5.27E-03
Ps90%/90% (+KTL) Un-Biased	4.27E+00	4.26E+00	4.27E+00	4.31E+00	4.33E+00
Ps90%/90% (-KTL) Un-Biased	4.25E+00	4.24E+00	4.26E+00	4.29E+00	4.30E+00
Specification MIN	4.00E+00	4.00E+00	4.00E+00	4.00E+00	4.00E+00
Status	PASS	PASS	PASS	PASS	PASS

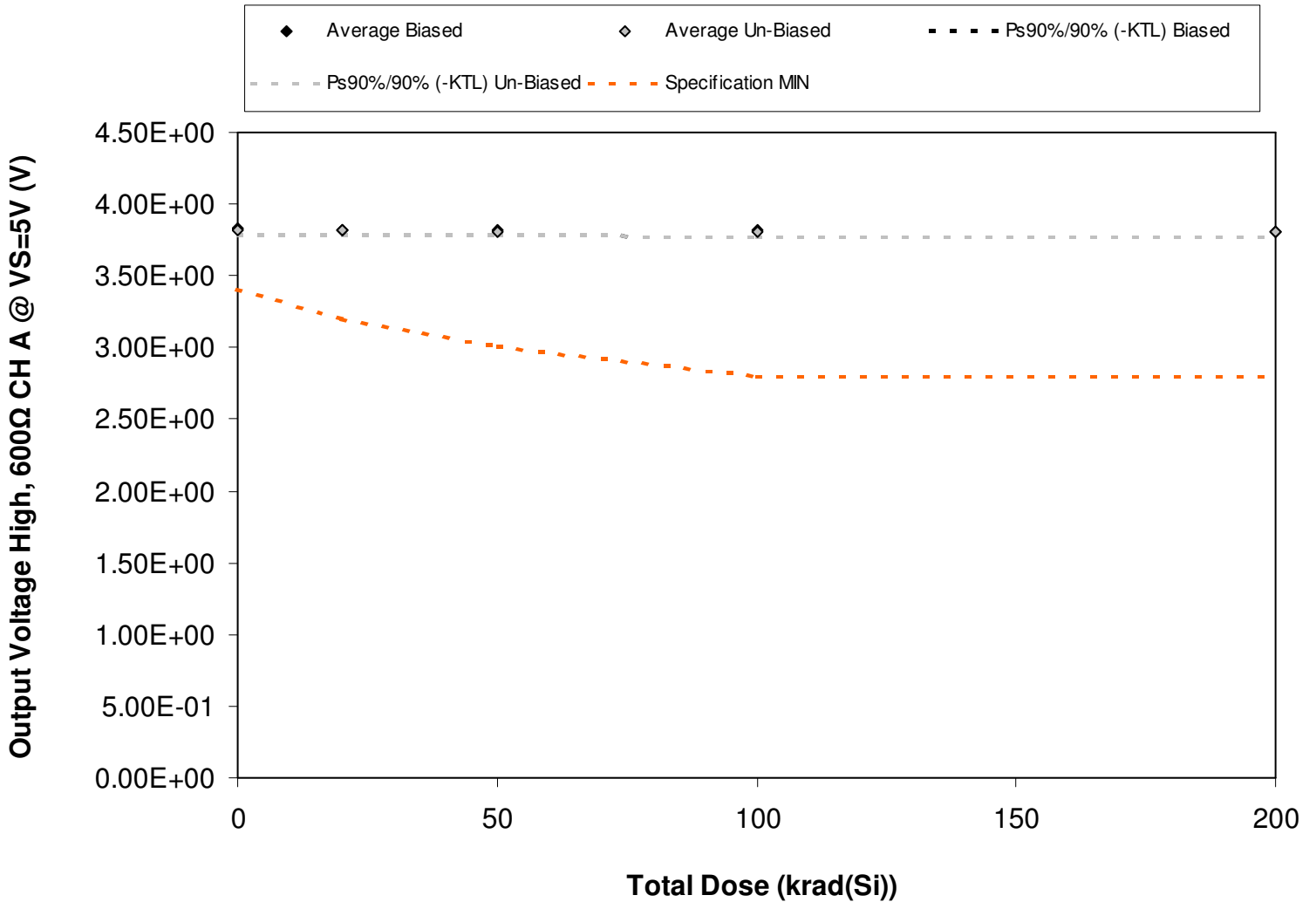

Figure 5.37. Plot of the output voltage high (600Ω load) at 5V for channel A versus total dose. The data show no significant change with total dose. The solid diamonds are the average of measured data points from the biased sample (devices irradiated with an electrical bias) while the shaded diamonds are the average from the unbiased sample. The black line(s) show the effects on the data after application of the biased KTL statistics (solid and/or dashed lines) while the gray line(s) show the effects on the data after application of the unbiased KTL statistics (solid and/or dashed lines). The red dashed line(s) are the minimum and/or maximum specification values as defined in the datasheet and/or test plan.



Table 5.37. Raw data of output voltage high (600Ω load) at 5V for channel A versus total dose, including the statistical analysis, the specification and the status of the testing (pass/fail).

Output Voltage High, 600Ω CH A @ VS=5V (V)	Total Dose (krad(Si))				
	0	20	50	100	200
Device					
1090	3.82E+00	3.82E+00	3.82E+00	3.81E+00	3.81E+00
1092	3.83E+00	3.83E+00	3.83E+00	3.82E+00	3.82E+00
1093	3.83E+00	3.83E+00	3.83E+00	3.82E+00	3.82E+00
1094	3.80E+00	3.80E+00	3.80E+00	3.79E+00	3.79E+00
1095	3.84E+00	3.84E+00	3.84E+00	3.83E+00	3.83E+00
1096	3.83E+00	3.82E+00	3.82E+00	3.82E+00	3.82E+00
1097	3.81E+00	3.81E+00	3.80E+00	3.80E+00	3.79E+00
1098	3.83E+00	3.83E+00	3.82E+00	3.82E+00	3.82E+00
1099	3.82E+00	3.82E+00	3.81E+00	3.81E+00	3.80E+00
1100	3.80E+00	3.80E+00	3.80E+00	3.79E+00	3.79E+00
1106	3.83E+00	3.83E+00	3.83E+00	3.83E+00	3.83E+00
1113	3.81E+00	3.81E+00	3.81E+00	3.80E+00	3.80E+00
Biased Statistics					
Average Biased	3.83E+00	3.82E+00	3.82E+00	3.82E+00	3.81E+00
Std Dev Biased	1.40E-02	1.36E-02	1.47E-02	1.52E-02	1.61E-02
Ps90%/90% (+KTL) Biased	3.86E+00	3.86E+00	3.86E+00	3.86E+00	3.86E+00
Ps90%/90% (-KTL) Biased	3.79E+00	3.79E+00	3.78E+00	3.77E+00	3.77E+00
Un-Biased Statistics					
Average Un-Biased	3.82E+00	3.81E+00	3.81E+00	3.81E+00	3.80E+00
Std Dev Un-Biased	1.07E-02	1.06E-02	1.09E-02	1.22E-02	1.30E-02
Ps90%/90% (+KTL) Un-Biased	3.85E+00	3.84E+00	3.84E+00	3.84E+00	3.84E+00
Ps90%/90% (-KTL) Un-Biased	3.79E+00	3.79E+00	3.78E+00	3.77E+00	3.77E+00
Specification MIN	3.40E+00	3.20E+00	3.00E+00	2.80E+00	2.80E+00
Status	PASS	PASS	PASS	PASS	PASS

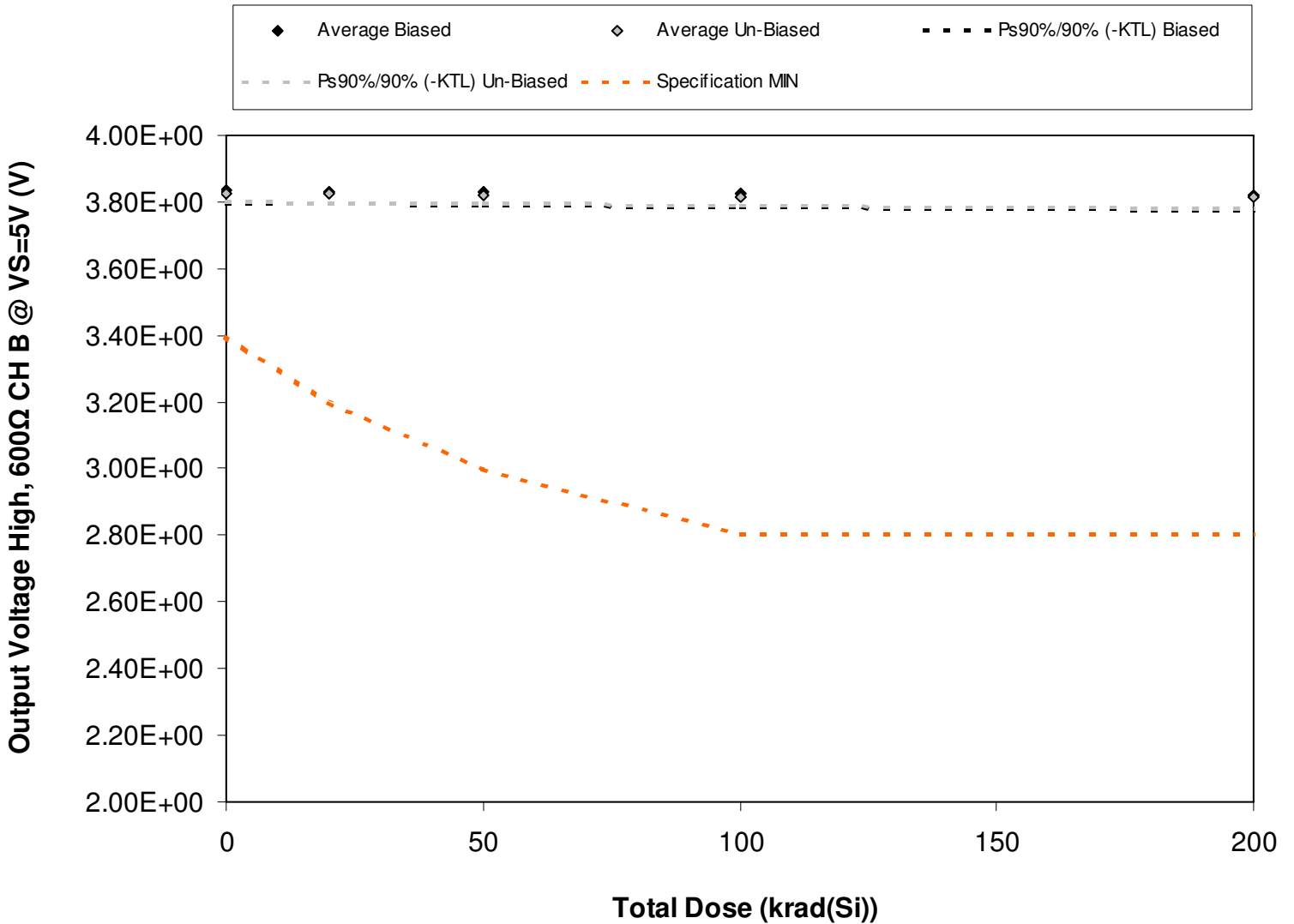

Figure 5.38. Plot of the output voltage high (600Ω load) at 5V for channel B versus total dose. The data show no significant change with total dose. The solid diamonds are the average of measured data points from the biased sample (devices irradiated with an electrical bias) while the shaded diamonds are the average from the un-biased sample. The black line(s) show the effects on the data after application of the biased KTL statistics (solid and/or dashed lines) while the gray line(s) show the effects on the data after application of the unbiased KTL statistics (solid and/or dashed lines). The red dashed line(s) are the minimum and/or maximum specification values as defined in the datasheet and/or test plan.



Table 5.38. Raw data of output voltage high (600Ω load) at 5V for channel B versus total dose, including the statistical analysis, the specification and the status of the testing (pass/fail).

Output Voltage High, 600Ω CH B @ VS=5V (V)	Total Dose (krad(Si))				
	0	20	50	100	200
Device					
1090	3.83E+00	3.83E+00	3.83E+00	3.82E+00	3.82E+00
1092	3.84E+00	3.84E+00	3.84E+00	3.83E+00	3.83E+00
1093	3.84E+00	3.84E+00	3.84E+00	3.83E+00	3.83E+00
1094	3.81E+00	3.81E+00	3.81E+00	3.80E+00	3.80E+00
1095	3.85E+00	3.85E+00	3.84E+00	3.84E+00	3.84E+00
1096	3.84E+00	3.84E+00	3.83E+00	3.83E+00	3.83E+00
1097	3.82E+00	3.81E+00	3.81E+00	3.81E+00	3.80E+00
1098	3.83E+00	3.83E+00	3.83E+00	3.83E+00	3.82E+00
1099	3.83E+00	3.83E+00	3.82E+00	3.82E+00	3.81E+00
1100	3.82E+00	3.81E+00	3.81E+00	3.81E+00	3.80E+00
1106	3.84E+00	3.84E+00	3.84E+00	3.83E+00	3.83E+00
1113	3.82E+00	3.82E+00	3.82E+00	3.82E+00	3.82E+00
Biased Statistics					
Average Biased	3.83E+00	3.83E+00	3.83E+00	3.83E+00	3.82E+00
Std Dev Biased	1.39E-02	1.37E-02	1.47E-02	1.58E-02	1.61E-02
Ps90%/90% (+KTL) Biased	3.87E+00	3.87E+00	3.87E+00	3.87E+00	3.86E+00
Ps90%/90% (-KTL) Biased	3.80E+00	3.79E+00	3.79E+00	3.78E+00	3.78E+00
Un-Biased Statistics					
Average Un-Biased	3.83E+00	3.82E+00	3.82E+00	3.82E+00	3.81E+00
Std Dev Un-Biased	9.34E-03	9.89E-03	9.59E-03	1.08E-02	1.21E-02
Ps90%/90% (+KTL) Un-Biased	3.85E+00	3.85E+00	3.85E+00	3.85E+00	3.85E+00
Ps90%/90% (-KTL) Un-Biased	3.80E+00	3.80E+00	3.79E+00	3.79E+00	3.78E+00
Specification MIN	3.40E+00	3.20E+00	3.00E+00	2.80E+00	2.80E+00
Status	PASS	PASS	PASS	PASS	PASS

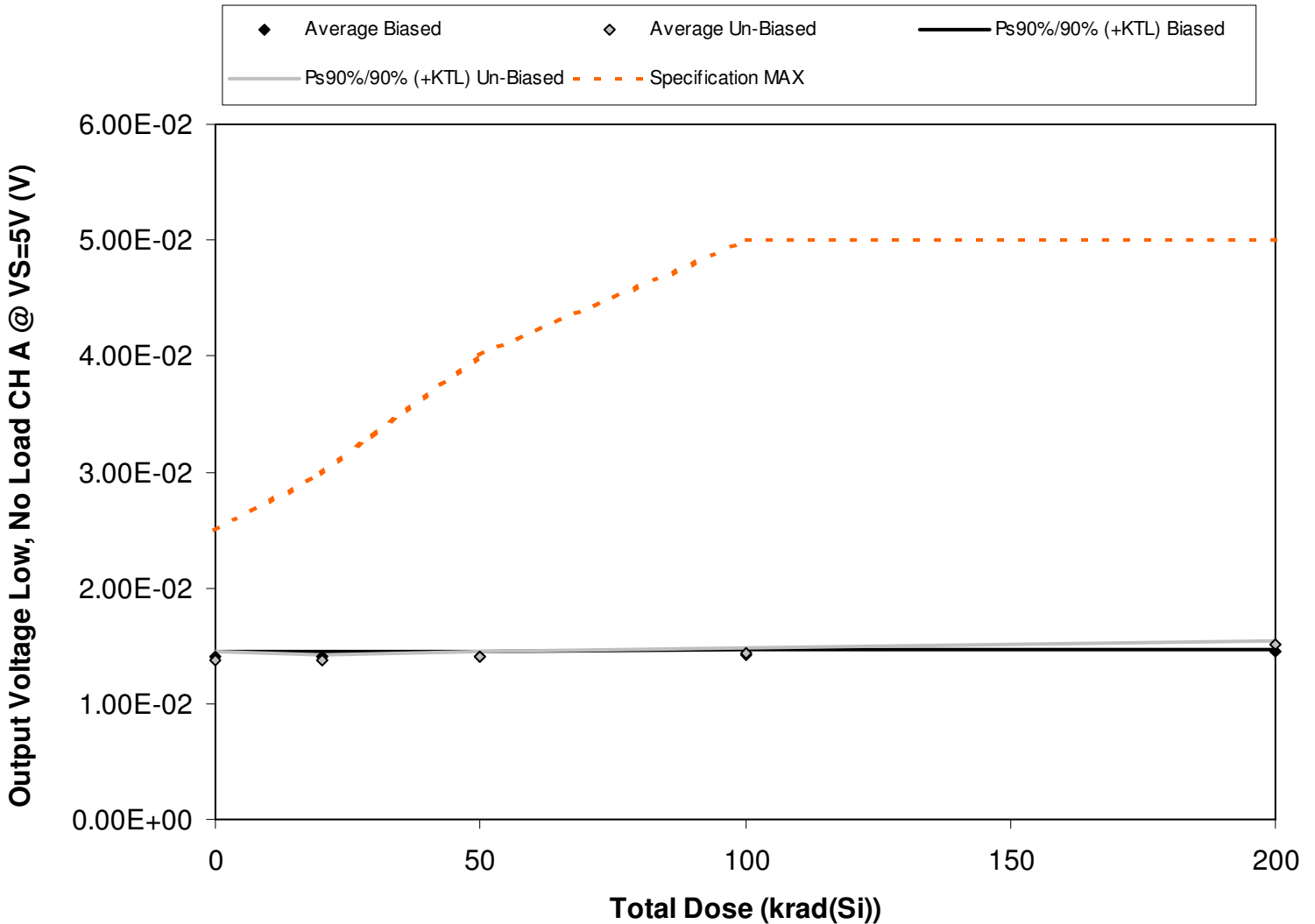

Figure 5.39. Plot of the output voltage low (no load) at 5V for channel A versus total dose. The data show no significant change with total dose. The solid diamonds are the average of measured data points from the biased sample (devices irradiated with an electrical bias) while the shaded diamonds are the average from the un-biased sample. The black line(s) show the effects on the data after application of the biased KTL statistics (solid and/or dashed lines) while the gray line(s) show the effects on the data after application of the unbiased KTL statistics (solid and/or dashed lines). The red dashed line(s) are the minimum and/or maximum specification values as defined in the datasheet and/or test plan.



Table 5.39. Raw data of output voltage low (no load) at 5V for channel A versus total dose, including the statistical analysis, the specification and the status of the testing (pass/fail).

Output Voltage Low, No Load CH A @ VS=5V (V)	Total Dose (krad(Si))				
	0	20	50	100	200
Device					
1090	1.40E-02	1.40E-02	1.40E-02	1.43E-02	1.46E-02
1092	1.41E-02	1.41E-02	1.41E-02	1.44E-02	1.46E-02
1093	1.41E-02	1.41E-02	1.43E-02	1.44E-02	1.46E-02
1094	1.36E-02	1.37E-02	1.39E-02	1.40E-02	1.45E-02
1095	1.41E-02	1.41E-02	1.42E-02	1.43E-02	1.46E-02
1096	1.37E-02	1.38E-02	1.39E-02	1.42E-02	1.50E-02
1097	1.37E-02	1.37E-02	1.39E-02	1.42E-02	1.50E-02
1098	1.42E-02	1.41E-02	1.43E-02	1.46E-02	1.52E-02
1099	1.37E-02	1.37E-02	1.39E-02	1.42E-02	1.51E-02
1100	1.36E-02	1.37E-02	1.39E-02	1.44E-02	1.53E-02
1106	1.40E-02	1.40E-02	1.41E-02	1.41E-02	1.40E-02
1113	1.37E-02	1.35E-02	1.35E-02	1.36E-02	1.36E-02
Biased Statistics					
Average Biased	1.40E-02	1.40E-02	1.41E-02	1.43E-02	1.46E-02
Std Dev Biased	2.17E-04	1.73E-04	1.58E-04	1.64E-04	4.47E-05
Ps90%/90% (+KTL) Biased	1.46E-02	1.45E-02	1.45E-02	1.47E-02	1.47E-02
Ps90%/90% (-KTL) Biased	1.34E-02	1.35E-02	1.37E-02	1.38E-02	1.45E-02
Un-Biased Statistics					
Average Un-Biased	1.38E-02	1.38E-02	1.40E-02	1.43E-02	1.51E-02
Std Dev Un-Biased	2.39E-04	1.73E-04	1.79E-04	1.79E-04	1.30E-04
Ps90%/90% (+KTL) Un-Biased	1.44E-02	1.43E-02	1.45E-02	1.48E-02	1.55E-02
Ps90%/90% (-KTL) Un-Biased	1.31E-02	1.33E-02	1.35E-02	1.38E-02	1.48E-02
Specification MAX	2.50E-02	3.00E-02	4.00E-02	5.00E-02	5.00E-02
Status	PASS	PASS	PASS	PASS	PASS

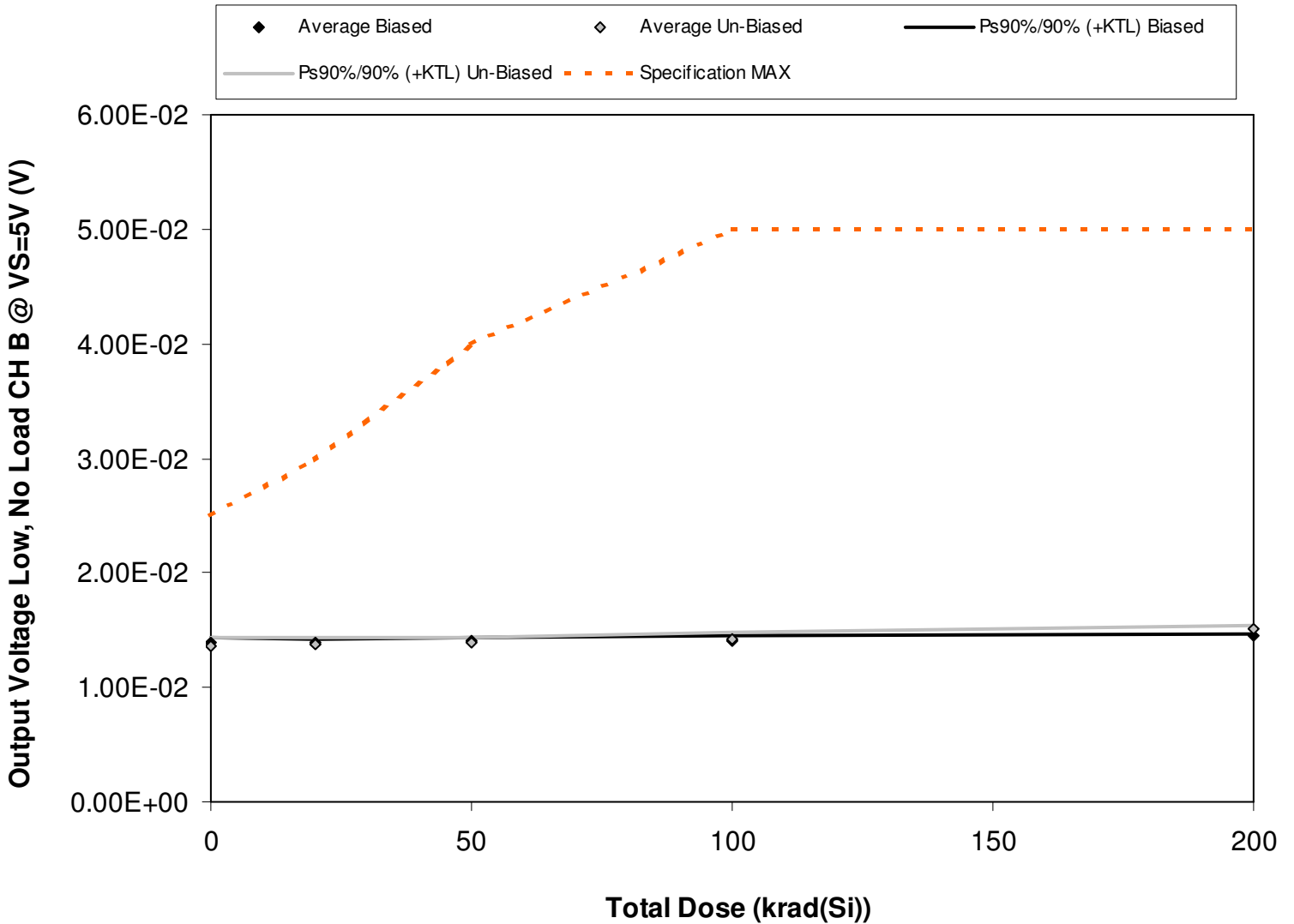

Figure 5.40. Plot of the output voltage low (no load) at 5V for channel B versus total dose. The data show no significant change with total dose. The solid diamonds are the average of measured data points from the biased sample (devices irradiated with an electrical bias) while the shaded diamonds are the average from the un-biased sample. The black line(s) show the effects on the data after application of the biased KTL statistics (solid and/or dashed lines) while the gray line(s) show the effects on the data after application of the unbiased KTL statistics (solid and/or dashed lines). The red dashed line(s) are the minimum and/or maximum specification values as defined in the datasheet and/or test plan.



Table 5.40. Raw data of output voltage low (no load) at 5V for channel B versus total dose, including the statistical analysis, the specification and the status of the testing (pass/fail).

Output Voltage Low, No Load CH B @ VS=5V (V)	Total Dose (krad(Si))				
	0	20	50	100	200
Device					
1090	1.39E-02	1.38E-02	1.41E-02	1.41E-02	1.45E-02
1092	1.40E-02	1.40E-02	1.40E-02	1.41E-02	1.46E-02
1093	1.41E-02	1.40E-02	1.42E-02	1.43E-02	1.46E-02
1094	1.36E-02	1.37E-02	1.39E-02	1.39E-02	1.46E-02
1095	1.39E-02	1.40E-02	1.41E-02	1.42E-02	1.45E-02
1096	1.35E-02	1.36E-02	1.37E-02	1.40E-02	1.49E-02
1097	1.36E-02	1.36E-02	1.37E-02	1.41E-02	1.49E-02
1098	1.41E-02	1.41E-02	1.42E-02	1.45E-02	1.51E-02
1099	1.36E-02	1.37E-02	1.39E-02	1.43E-02	1.51E-02
1100	1.35E-02	1.36E-02	1.38E-02	1.43E-02	1.52E-02
1106	1.40E-02	1.41E-02	1.40E-02	1.39E-02	1.40E-02
1113	1.35E-02	1.35E-02	1.35E-02	1.34E-02	1.35E-02
Biased Statistics					
Average Biased	1.39E-02	1.39E-02	1.41E-02	1.41E-02	1.46E-02
Std Dev Biased	1.87E-04	1.41E-04	1.14E-04	1.48E-04	5.48E-05
Ps90%/90% (+KTL) Biased	1.44E-02	1.43E-02	1.44E-02	1.45E-02	1.47E-02
Ps90%/90% (-KTL) Biased	1.34E-02	1.35E-02	1.37E-02	1.37E-02	1.44E-02
Un-Biased Statistics					
Average Un-Biased	1.37E-02	1.37E-02	1.39E-02	1.42E-02	1.50E-02
Std Dev Un-Biased	2.51E-04	2.17E-04	2.07E-04	1.95E-04	1.34E-04
Ps90%/90% (+KTL) Un-Biased	1.43E-02	1.43E-02	1.44E-02	1.48E-02	1.54E-02
Ps90%/90% (-KTL) Un-Biased	1.30E-02	1.31E-02	1.33E-02	1.37E-02	1.47E-02
Specification MAX	2.50E-02	3.00E-02	4.00E-02	5.00E-02	5.00E-02
Status	PASS	PASS	PASS	PASS	PASS

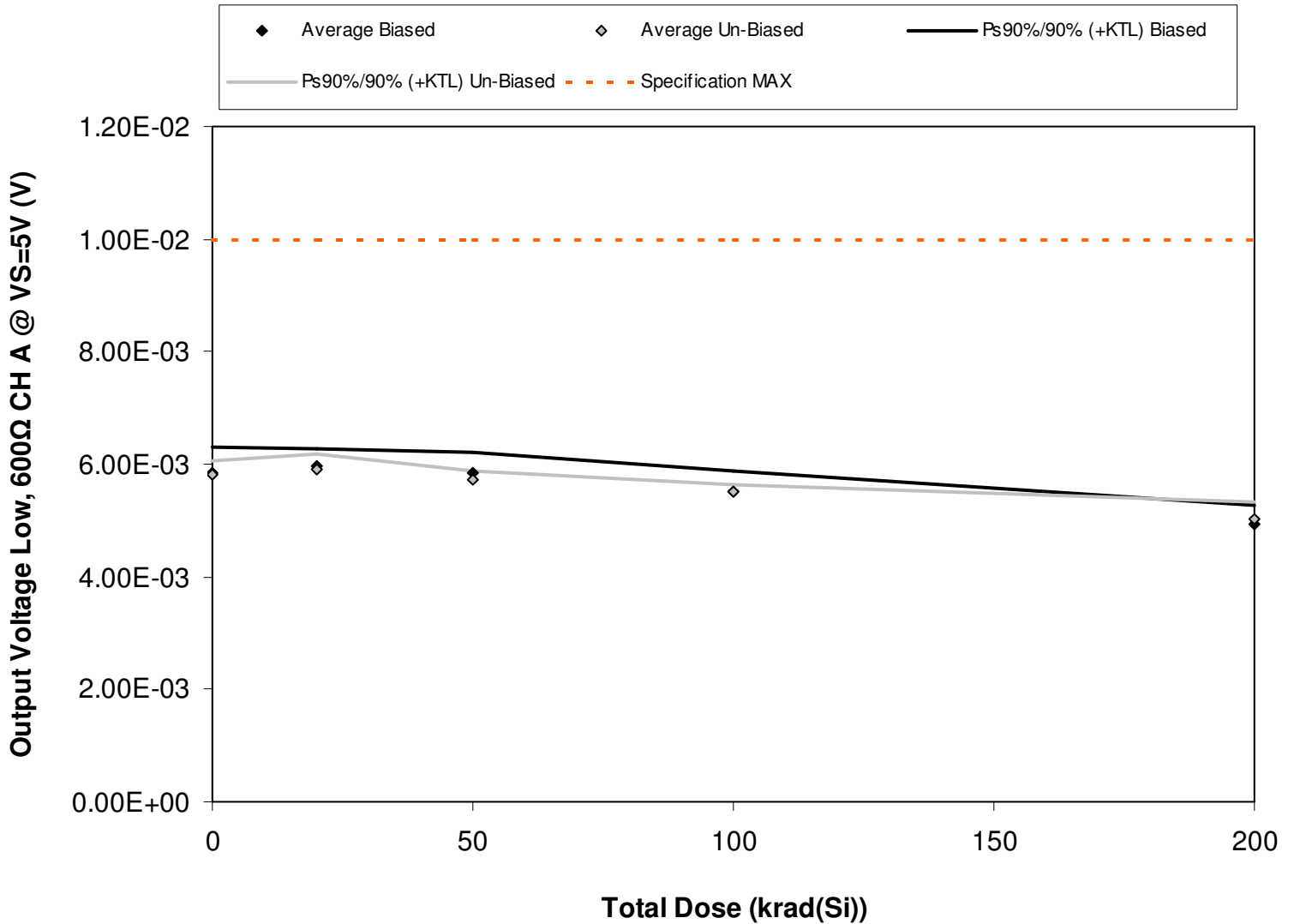

Figure 5.41. Plot of the output voltage low (600Ω load) at 5V for channel A versus total dose. The data show no significant change with total dose. The solid diamonds are the average of measured data points from the biased sample (devices irradiated with an electrical bias) while the shaded diamonds are the average from the un-biased sample. The black line(s) show the effects on the data after application of the biased KTL statistics (solid and/or dashed lines) while the gray line(s) show the effects on the data after application of the unbiased KTL statistics (solid and/or dashed lines). The red dashed line(s) are the minimum and/or maximum specification values as defined in the datasheet and/or test plan.



Table 5.41. Raw data of output voltage low (600Ω load) at 5V for channel A versus total dose, including the statistical analysis, the specification and the status of the testing (pass/fail).

Output Voltage Low, 600Ω CH A @ VS=5V (V)	Total Dose (krad(Si))				
	0	20	50	100	200
Device					
1090	5.80E-03	5.90E-03	5.90E-03	5.40E-03	4.80E-03
1092	6.00E-03	6.10E-03	5.90E-03	5.60E-03	4.90E-03
1093	6.00E-03	6.00E-03	5.90E-03	5.60E-03	5.00E-03
1094	5.60E-03	5.80E-03	5.60E-03	5.30E-03	4.80E-03
1095	5.90E-03	6.00E-03	5.90E-03	5.60E-03	5.10E-03
1096	5.70E-03	5.90E-03	5.70E-03	5.50E-03	5.10E-03
1097	5.80E-03	5.80E-03	5.70E-03	5.50E-03	5.10E-03
1098	5.90E-03	6.00E-03	5.80E-03	5.60E-03	5.10E-03
1099	5.90E-03	6.00E-03	5.80E-03	5.50E-03	4.90E-03
1100	5.80E-03	5.80E-03	5.70E-03	5.50E-03	4.90E-03
1106	5.90E-03	5.90E-03	5.90E-03	5.90E-03	5.90E-03
1113	5.80E-03	5.80E-03	5.80E-03	5.80E-03	5.90E-03
Biased Statistics					
Average Biased	5.86E-03	5.96E-03	5.84E-03	5.50E-03	4.92E-03
Std Dev Biased	1.67E-04	1.14E-04	1.34E-04	1.41E-04	1.30E-04
Ps90%/90% (+KTL) Biased	6.32E-03	6.27E-03	6.21E-03	5.89E-03	5.28E-03
Ps90%/90% (-KTL) Biased	5.40E-03	5.65E-03	5.47E-03	5.11E-03	4.56E-03
Un-Biased Statistics					
Average Un-Biased	5.82E-03	5.90E-03	5.74E-03	5.52E-03	5.02E-03
Std Dev Un-Biased	8.37E-05	1.00E-04	5.48E-05	4.47E-05	1.10E-04
Ps90%/90% (+KTL) Un-Biased	6.05E-03	6.17E-03	5.89E-03	5.64E-03	5.32E-03
Ps90%/90% (-KTL) Un-Biased	5.59E-03	5.63E-03	5.59E-03	5.40E-03	4.72E-03
Specification MAX	1.00E-02	1.00E-02	1.00E-02	1.00E-02	1.00E-02
Status	PASS	PASS	PASS	PASS	PASS

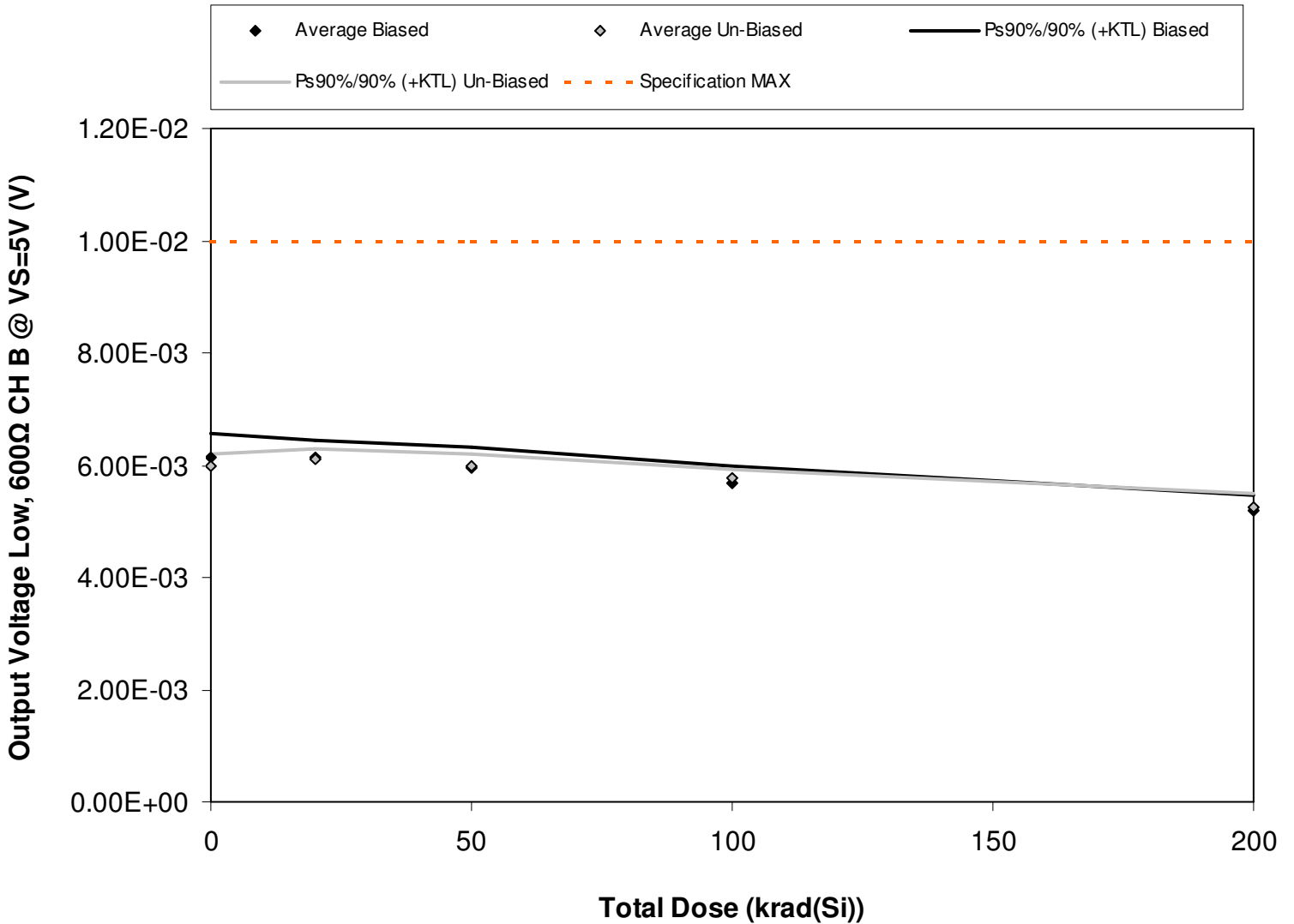

Figure 5.42. Plot of the output voltage low (600Ω load) at 5V for channel B versus total dose. The data show no significant change with total dose. The solid diamonds are the average of measured data points from the biased sample (devices irradiated with an electrical bias) while the shaded diamonds are the average from the un-biased sample. The black line(s) show the effects on the data after application of the biased KTL statistics (solid and/or dashed lines) while the gray line(s) show the effects on the data after application of the unbiased KTL statistics (solid and/or dashed lines). The red dashed line(s) are the minimum and/or maximum specification values as defined in the datasheet and/or test plan.



Table 5.42. Raw data of output voltage low (600Ω load) at 5V for channel B versus total dose, including the statistical analysis, the specification and the status of the testing (pass/fail).

Output Voltage Low, 600Ω CH B @ VS=5V (V)	Total Dose (krad(Si))				
	0	20	50	100	200
Device					
1090	6.20E-03	6.10E-03	6.00E-03	5.70E-03	5.10E-03
1092	6.20E-03	6.10E-03	6.00E-03	5.70E-03	5.10E-03
1093	6.10E-03	6.20E-03	6.00E-03	5.70E-03	5.30E-03
1094	5.90E-03	6.00E-03	5.70E-03	5.50E-03	5.10E-03
1095	6.30E-03	6.30E-03	6.00E-03	5.80E-03	5.30E-03
1096	6.00E-03	6.10E-03	6.00E-03	5.80E-03	5.30E-03
1097	5.90E-03	6.10E-03	6.00E-03	5.70E-03	5.30E-03
1098	6.10E-03	6.20E-03	6.00E-03	5.80E-03	5.30E-03
1099	6.00E-03	6.10E-03	6.10E-03	5.80E-03	5.10E-03
1100	5.90E-03	6.00E-03	5.90E-03	5.70E-03	5.20E-03
1106	6.20E-03	6.10E-03	6.00E-03	6.10E-03	6.10E-03
1113	6.10E-03	6.10E-03	6.00E-03	6.00E-03	6.00E-03
Biased Statistics					
Average Biased	6.14E-03	6.14E-03	5.94E-03	5.68E-03	5.18E-03
Std Dev Biased	1.52E-04	1.14E-04	1.34E-04	1.10E-04	1.10E-04
Ps90%/90% (+KTL) Biased	6.56E-03	6.45E-03	6.31E-03	5.98E-03	5.48E-03
Ps90%/90% (-KTL) Biased	5.72E-03	5.83E-03	5.57E-03	5.38E-03	4.88E-03
Un-Biased Statistics					
Average Un-Biased	5.98E-03	6.10E-03	6.00E-03	5.76E-03	5.24E-03
Std Dev Un-Biased	8.37E-05	7.07E-05	7.07E-05	5.48E-05	8.94E-05
Ps90%/90% (+KTL) Un-Biased	6.21E-03	6.29E-03	6.19E-03	5.91E-03	5.49E-03
Ps90%/90% (-KTL) Un-Biased	5.75E-03	5.91E-03	5.81E-03	5.61E-03	4.99E-03
Specification MAX	1.00E-02	1.00E-02	1.00E-02	1.00E-02	1.00E-02
Status	PASS	PASS	PASS	PASS	PASS

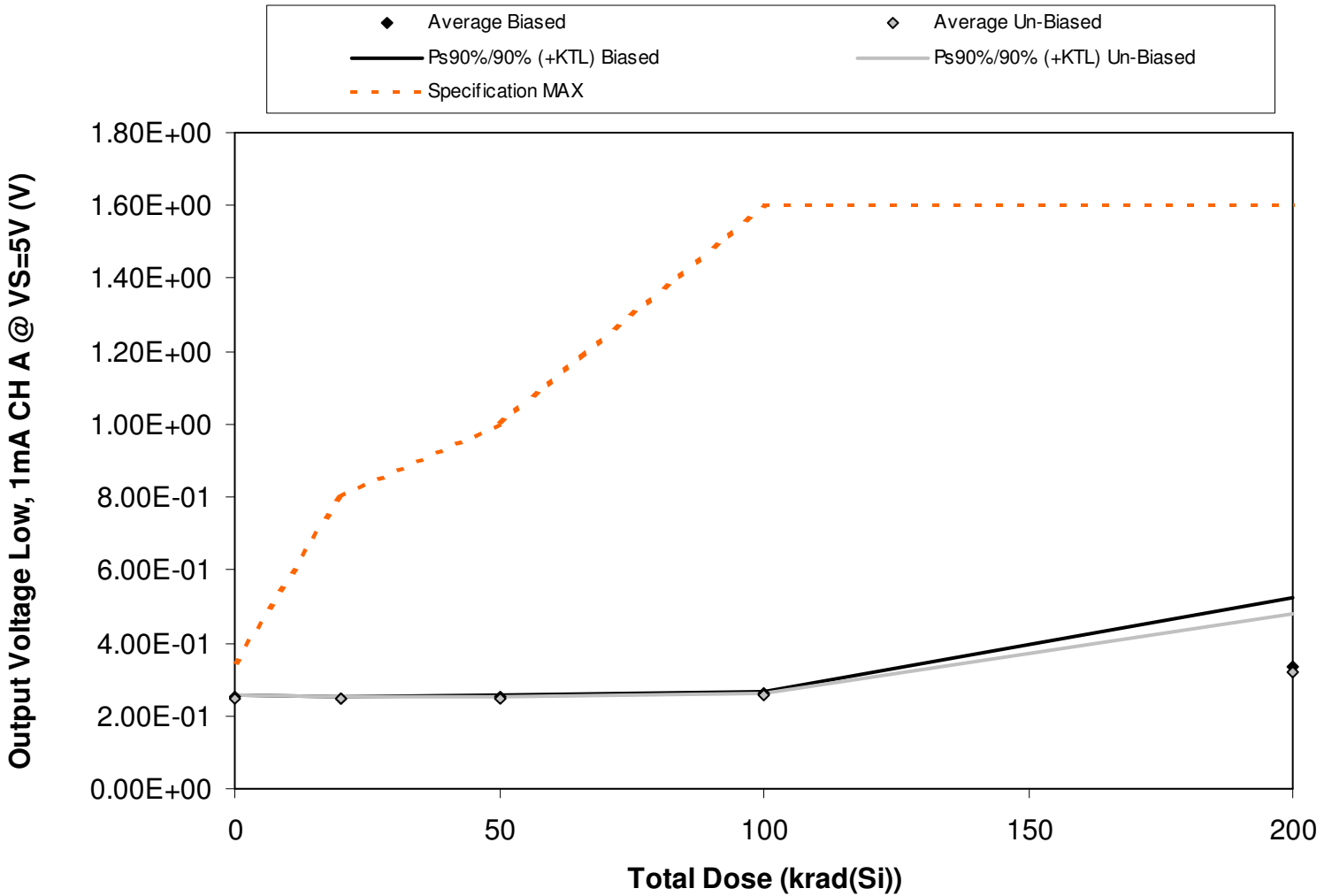

Figure 5.43. Plot of the output voltage low (1mA load) at 5V for channel A versus total dose. The data show no significant change with total dose. The solid diamonds are the average of measured data points from the biased sample (devices irradiated with an electrical bias) while the shaded diamonds are the average from the un-biased sample. The black line(s) show the effects on the data after application of the biased KTL statistics (solid and/or dashed lines) while the gray line(s) show the effects on the data after application of the unbiased KTL statistics (solid and/or dashed lines). The red dashed line(s) are the minimum and/or maximum specification values as defined in the datasheet and/or test plan.



Table 5.43. Raw data of the output voltage low (1mA load) at 5V for channel A versus total dose, including the statistical analysis, the specification and the status of the testing (pass/fail).

Output Voltage Low, 1mA CH A @ VS=5V (V)	Total Dose (krad(Si))				
	0	20	50	100	200
Device					
1090	2.49E-01	2.46E-01	2.51E-01	2.59E-01	3.24E-01
1092	2.48E-01	2.46E-01	2.49E-01	2.58E-01	3.06E-01
1093	2.49E-01	2.47E-01	2.49E-01	2.58E-01	2.96E-01
1094	2.53E-01	2.51E-01	2.54E-01	2.65E-01	4.57E-01
1095	2.52E-01	2.49E-01	2.53E-01	2.61E-01	3.00E-01
1096	2.49E-01	2.45E-01	2.48E-01	2.57E-01	2.96E-01
1097	2.51E-01	2.47E-01	2.50E-01	2.60E-01	2.99E-01
1098	2.53E-01	2.48E-01	2.51E-01	2.59E-01	2.88E-01
1099	2.48E-01	2.44E-01	2.48E-01	2.56E-01	3.05E-01
1100	2.48E-01	2.45E-01	2.49E-01	2.59E-01	4.24E-01
1106	2.50E-01	2.49E-01	2.49E-01	2.49E-01	2.49E-01
1113	2.48E-01	2.47E-01	2.47E-01	2.47E-01	2.46E-01
Biased Statistics					
Average Biased	2.50E-01	2.48E-01	2.51E-01	2.60E-01	3.37E-01
Std Dev Biased	2.17E-03	2.17E-03	2.28E-03	2.95E-03	6.82E-02
Ps90%/90% (+KTL) Biased	2.56E-01	2.54E-01	2.57E-01	2.68E-01	5.23E-01
Ps90%/90% (-KTL) Biased	2.44E-01	2.42E-01	2.45E-01	2.52E-01	1.50E-01
Un-Biased Statistics					
Average Un-Biased	2.50E-01	2.46E-01	2.49E-01	2.58E-01	3.22E-01
Std Dev Un-Biased	2.17E-03	1.64E-03	1.30E-03	1.64E-03	5.71E-02
Ps90%/90% (+KTL) Un-Biased	2.56E-01	2.50E-01	2.53E-01	2.63E-01	4.79E-01
Ps90%/90% (-KTL) Un-Biased	2.44E-01	2.41E-01	2.46E-01	2.54E-01	1.66E-01
Specification MAX	3.50E-01	8.00E-01	1.00E+00	1.60E+00	1.60E+00
Status	PASS	PASS	PASS	PASS	PASS

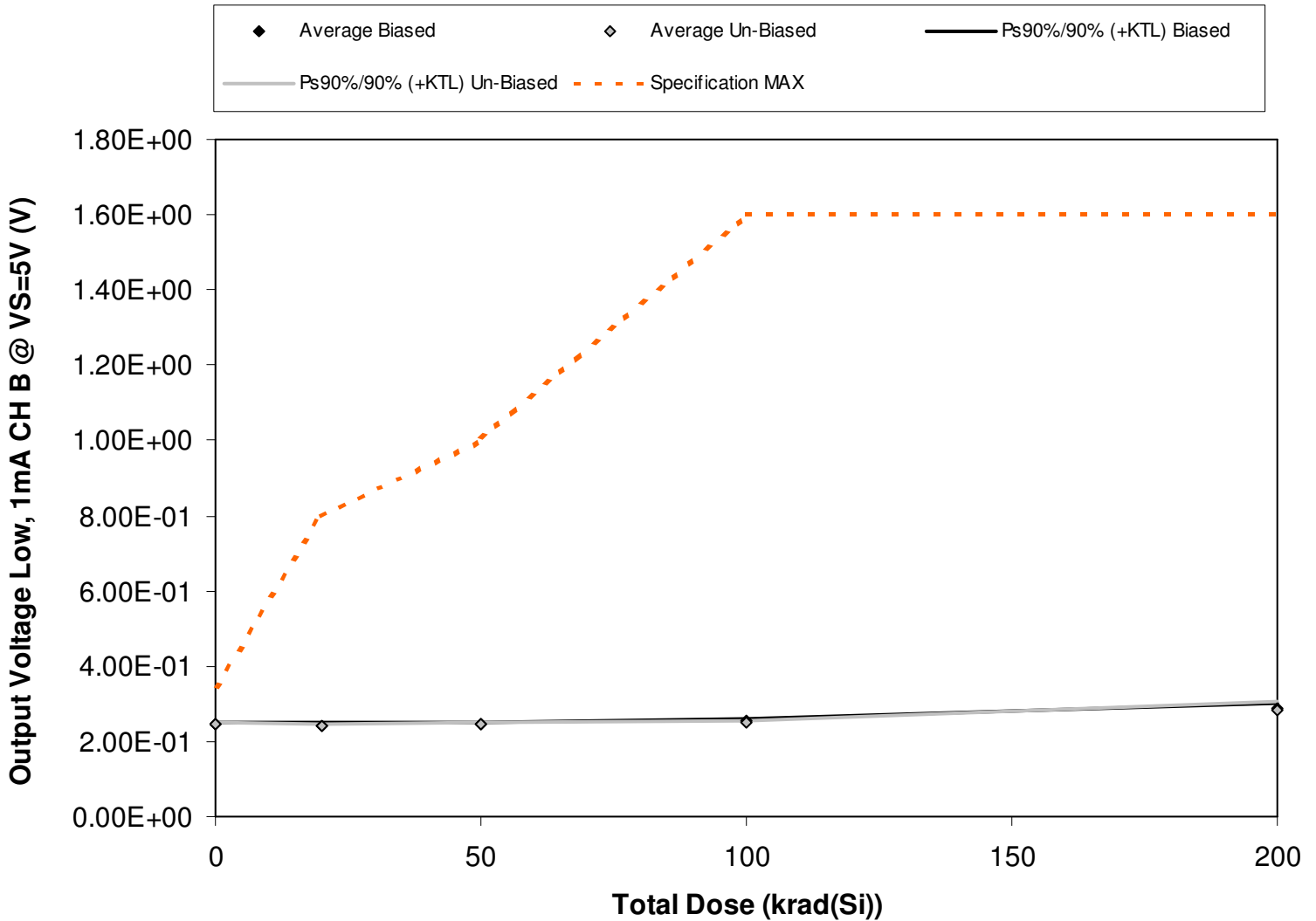

Figure 5.44. Plot of the output voltage low (1mA load) at 5V for channel B versus total dose. The data show no significant change with total dose. The solid diamonds are the average of measured data points from the biased sample (devices irradiated with an electrical bias) while the shaded diamonds are the average from the un-biased sample. The black line(s) show the effects on the data after application of the biased KTL statistics (solid and/or dashed lines) while the gray line(s) show the effects on the data after application of the unbiased KTL statistics (solid and/or dashed lines). The red dashed line(s) are the minimum and/or maximum specification values as defined in the datasheet and/or test plan.



Table 5.44. Raw data of the output voltage low (1mA load) at 5V for channel B versus total dose, including the statistical analysis, the specification and the status of the testing (pass/fail).

Output Voltage Low, 1mA CH B @ VS=5V (V)	Total Dose (krad(Si))				
	0	20	50	100	200
Device					
1090	2.44E-01	2.41E-01	2.45E-01	2.52E-01	2.88E-01
1092	2.43E-01	2.40E-01	2.44E-01	2.52E-01	2.83E-01
1093	2.46E-01	2.42E-01	2.45E-01	2.52E-01	2.80E-01
1094	2.48E-01	2.46E-01	2.49E-01	2.57E-01	2.96E-01
1095	2.46E-01	2.44E-01	2.47E-01	2.54E-01	2.81E-01
1096	2.43E-01	2.39E-01	2.42E-01	2.48E-01	2.76E-01
1097	2.46E-01	2.42E-01	2.45E-01	2.53E-01	2.78E-01
1098	2.48E-01	2.45E-01	2.46E-01	2.53E-01	2.76E-01
1099	2.43E-01	2.40E-01	2.43E-01	2.50E-01	2.81E-01
1100	2.42E-01	2.39E-01	2.44E-01	2.52E-01	2.96E-01
1106	2.46E-01	2.45E-01	2.45E-01	2.45E-01	2.45E-01
1113	2.43E-01	2.41E-01	2.41E-01	2.41E-01	2.40E-01
Biased Statistics					
Average Biased	2.45E-01	2.43E-01	2.46E-01	2.53E-01	2.86E-01
Std Dev Biased	1.95E-03	2.41E-03	2.00E-03	2.19E-03	6.58E-03
Ps90%/90% (+KTL) Biased	2.51E-01	2.49E-01	2.51E-01	2.59E-01	3.04E-01
Ps90%/90% (-KTL) Biased	2.40E-01	2.36E-01	2.41E-01	2.47E-01	2.68E-01
Un-Biased Statistics					
Average Un-Biased	2.44E-01	2.41E-01	2.44E-01	2.51E-01	2.81E-01
Std Dev Un-Biased	2.51E-03	2.55E-03	1.58E-03	2.17E-03	8.41E-03
Ps90%/90% (+KTL) Un-Biased	2.51E-01	2.48E-01	2.48E-01	2.57E-01	3.04E-01
Ps90%/90% (-KTL) Un-Biased	2.38E-01	2.34E-01	2.40E-01	2.45E-01	2.58E-01
Specification MAX	3.50E-01	8.00E-01	1.00E+00	1.60E+00	1.60E+00
Status	PASS	PASS	PASS	PASS	PASS



6.0. Summary / Conclusions

The total ionizing dose testing described in this final report was performed using the facilities at Radiation Assured Devices' Longmire Laboratories in Colorado Springs, CO. The high dose rate total ionizing dose (TID) source is a JLSA 84-21 irradiator modified to provide a panoramic exposure. The Co-60 rods are held in the base of the irradiator heavily shielded by lead, during the radiation exposures the rod is raised by an electronic timer/controller and the exposure is performed in air. The dose rate for this irradiator in this configuration ranges from $<1\text{rad(Si)/s}$ to a maximum of approximately 120rad(Si)/s , determined by the distance from the source.

The parametric data was obtained as "read and record" and all the raw data plus an attributes summary were presented in this report. The attributes data contains the average, standard deviation and the average with the KTL values applied. The KTL value used was 2.742 per MIL HDBK 814 using one-sided tolerance limits of 99/90 and a 5-piece sample size. Note that the following criteria was used to determine the outcome of the testing: following the radiation exposure each parameter had to pass the specification value and the average value for the five-piece sample must pass the specification value when the KTL limits are applied. If these conditions were not both satisfied following the radiation exposure, then the lot would be logged as an RLAT failure.

Based on these criteria, the RH1013 dual operational amplifier discussed in this report passed the radiation lot acceptance test to the highest level tested of 200krad(Si) . The units showed no significant degradation to most of the measured parameters. As seen in this report, several parameters suffered measurable radiation-induced degradation, however in no case was it sufficient to cause the parameters to go out of specification even after application of the KTL statistics.



Appendix A: TID Bias Connections

(Extracted from LINEAR TECHNOLOGY CORPORATION RH1013M Dual Precision Operational Amplifier Datasheet)

Biased Samples:

Pin	Function	Bias
1	OUT A	To Pin 2 Via 10k Ω Resistor
2	-IN A	To Pin 1 Via 10k Ω Resistor
3	+IN A	8V Via 10k Ω Resistor
4	V-	-15V Decoupled to GND w/ 0.1 μ F
5	+IN B	8V Via 10k Ω Resistor
6	-IN B	To Pin 7 Via 10k Ω Resistor
7	OUT B	To Pin 6 Via 10k Ω Resistor
8	V+	+15V Decoupled to GND w/ 0.1 μ F

Unbiased Samples (All Pins Tied to Ground):

Pin	Function	Bias
1	OUT A	GND
2	-IN A	GND
3	+IN A	GND
4	V-	GND
5	+IN B	GND
6	-IN B	GND
7	OUT B	GND
8	V+	GND

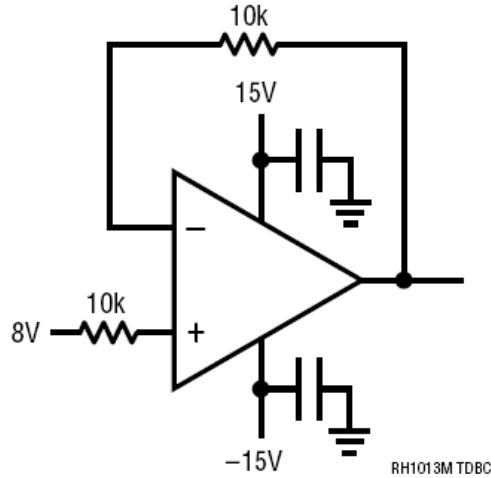

Figure A.1. Irradiation bias drawing for the units to be irradiated under electrical bias. This figure was extracted from the LINEAR TECHNOLOGY CORPORATION RH1013M Dual Precision Operational Amplifier Datasheet.

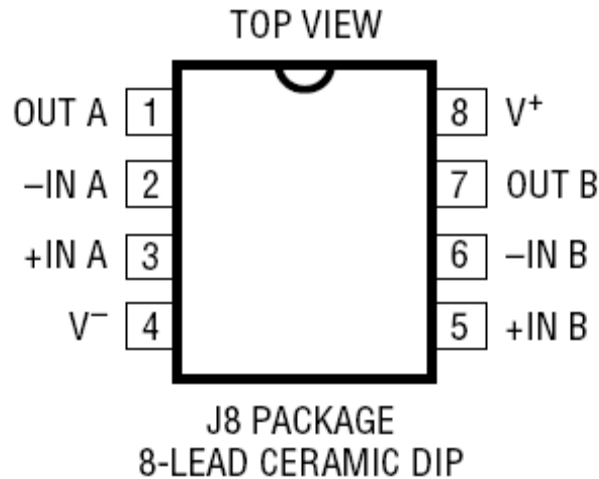
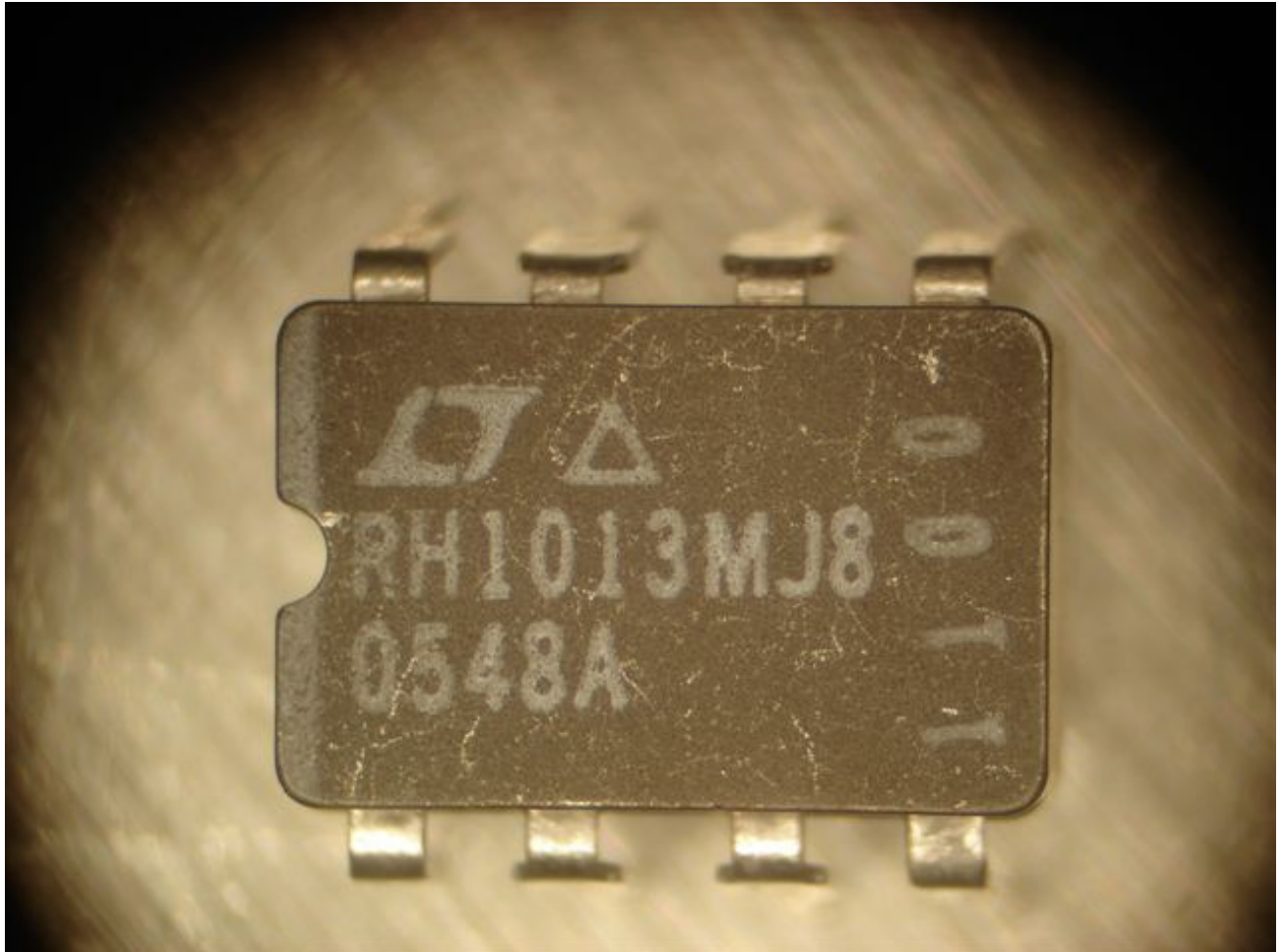

Figure A.2. Package drawing (for reference only). This figure was extracted from the LINEAR TECHNOLOGY CORPORATION RH1013M Quad Precision Operational Amplifier Datasheet.



Appendix B: Photograph of device-under-test to show part markings





Appendix C: Electrical Test Parameters and Conditions

All electrical tests for this device are performed on Radiation Assured Device's LTS2020 Test System. The LTS2020 Test System is a programmable parametric tester that provides parameter measurements for a variety of digital, analog and mixed signal products including voltage regulators, voltage comparators, D to A and A to D converters. The LTS2020 Test System achieves accuracy and sensitivity through the use of software self-calibration and an internal relay matrix with separate family boards and custom personality adapter boards. The tester uses this relay matrix to connect the required test circuits, select the appropriate voltage / current sources and establish the needed measurement loops for all the tests performed. The measured parameters and test conditions are shown in Table C.1.

A listing of the measurement precision/resolution for each parameter is shown in Table C.2. The precision/resolution values were obtained either from test data or from the DAC resolution of the LTS-2020. To generate the precision/resolution shown in Table C.2, one of the units-under-test was tested repetitively (a total of 10-times with re-insertion between tests) to obtain the average test value and standard deviation. Using this test data MIL-HDBK-814 90/90 KTL statistics were applied to the measured standard deviation to generate the final measurement range. This value encompasses the precision/resolution of all aspects of the test system, including the LTS2020 mainframe, family board, socket assembly and DUT board as well as insertion error. In some cases, the measurement resolution is limited by the internal DACs, which results in a measured standard deviation of zero. In these instances the precision/resolution will be reported back as the LSB of the DAC.

Note that the testing and statistics used in this document are based on an "analysis of variables" technique, which relies on small sample sizes to qualify much larger lot sizes (see MIL-HDBK-814, p. 91 for a discussion of statistical treatments). Unfortunately, not all measured parameters are well suited to this approach due to inherent large variations. One such parameter is pre-irradiation Open Loop Gain, where the device exhibits extreme sensitivity to input conditions, resulting in a very large standard deviation and a statistical error often greater than the measured value. If necessary, larger samples sizes could be used to qualify these parameters using an "attributes" approach.



Table C.1. Measured parameters and test conditions for the RH1013MJ8. Unless otherwise noted the conditions were selected to match the post-irradiation specifications. See LINEAR TECHNOLOGY CORPORATION RH1013M Dual Precision Operational Amplifier Datasheet for the post irradiation test conditions and specifications.

Test Number	Test Description	Test Conditions
1	Positive Supply Current (ICC+)	$V_S = \pm 15V$
2	Negative Supply Current (IEE-)	$V_S = \pm 15V$
3	Input Offset Voltage ($V_{OS1} - V_{OS2}$)	$V_S = \pm 15V$
4	Input Offset Current ($I_{OS1} - I_{OS2}$)	$V_S = \pm 15V$
5	+ Input Bias Current ($I_{B+1} - I_{B+2}$)	$V_S = \pm 15V$
6	- Input Bias Current ($I_{B-1} - I_{B-2}$)	$V_S = \pm 15V$
7	Common Mode Rejection Ratio (CMRR1-CMRR2)	$V_{CM} = 13V, -15V$
8	Power Supply Rejection Ratio (PSRR1-PSRR2)	$V_S = \pm 10V$ to $\pm 18V$
9	Large Signal Voltage Gain ($A_{VOL1} - A_{VOL2}$)	$V_S = \pm 15V, V_O = \pm 10V, R_L = 10k\Omega$
10	Positive Output Voltage Swing ($V_{OUT+1} - V_{OUT+2}$)	$V_S = \pm 15V, R_L = 10k\Omega$
11	Negative Output Voltage Swing ($V_{OUT-1} - V_{OUT-2}$)	$V_S = \pm 15V, R_L = 10k\Omega$
12	Positive Slew Rate (SlewRate+1-SlewRate+2)	$V_S = \pm 15V, R_L = 10k\Omega$
13	Negative Slew Rate (SlewRate-1-SlewRate-2)	$V_S = \pm 15V, R_L = 10k\Omega$
14	Positive Supply Current (ICC+2)	$V_S = +5V$
15	Negative Supply Current (IEE-2)	$V_S = +5V$
16	Input Offset Voltage ($V_{OS3} - V_{OS4}$)	$V_S = +5V$
17	Input Offset Current ($I_{OS3} - I_{OS4}$)	$V_S = +5V$
18	+ Input Bias Current ($I_{B+3} - I_{B+4}$)	$V_S = +5V$
19	- Input Bias Current ($I_{B-3} - I_{B-4}$)	$V_S = +5V$
20	Positive Output Voltage Swing ($V_{OUT+3} - V_{OUT+4}$)	$V_S = +5V, \text{No Load}$
21	Positive Output Voltage Swing ($V_{OUT+5} - V_{OUT+6}$)	$V_S = +5V, R_L = 600\Omega$
22	Negative Output Voltage Swing ($V_{OUT-3} - V_{OUT-4}$)	$V_S = +5V, \text{No Load}$
23	Negative Output Voltage Swing ($V_{OUT-5} - V_{OUT-6}$)	$V_S = +5V, R_L = 600\Omega$
24	Negative Output Voltage Swing ($V_{OUT-7} - V_{OUT-8}$)	$V_S = +5V, I_{SINK} = 1mA$



Table C.2. Measured parameters, pre-irradiation specifications and measurement resolution for the RH1013MJ8.

Measured Parameter	Pre-Irradiation Specification	Measurement Precision/Resolution
Positive Supply Current (ICC+)	1.1mA MAX	±2.83E-6A
Negative Supply Current (IEE-)	-1.1mA MIN	±2.05E-6A
Input Offset Voltage (V _{OS1} -V _{OS2})	±300µV MAX	±2.61E-6V
Input Offset Current (I _{OS1} -I _{OS2})	±10nA MAX	±2.65E-10A
+ Input Bias Current (I _{B+1} -I _{B+2})	±30nA MAX	±5.05E-11A
- Input Bias Current (I _{B-1} -I _{B-2})	±30nA MAX	±3.49E-10A
Common Mode Rejection Ratio (CMRR1-CMRR2)	97dB MIN	±0.88dB
Power Supply Rejection Ratio (PSRR1-PSRR2)	100dB MIN	±10.9dB
Large Signal Voltage Gain (A _{VOL1} -A _{VOL2})	1200V/mV MIN	±9.36E3V/mV
Positive Output Voltage Swing (V _{OUT+1} -V _{OUT+2})	12.5V MIN	±1.31E-3V
Negative Output Voltage Swing (V _{OUT-1} -V _{OUT-2})	-12.5V MAX	±1.44E-3V
Positive Slew Rate (SlewRate+1-SlewRate+2)	0.2V/ µs MIN	±1.30E-2V/ µs
Negative Slew Rate (SlewRate-1-SlewRate-2)	-0.2V/ µs MAX	±1.97E-2V/ µs
Positive Supply Current (ICC+2)	1.0mA MAX	±2.62E-6A
Negative Supply Current (IEE-2)	-1.0mA MIN	±3.70E-6A
Input Offset Voltage (V _{OS3} -V _{OS4})	±450µV MAX	±1.63E-6V
Input Offset Current (I _{OS3} -I _{OS4})	±10nA MAX	±1.11E-10A
+ Input Bias Current (I _{B+3} -I _{B+4})	±50nA MAX	±4.23E-11A
- Input Bias Current (I _{B-3} -I _{B-4})	±50nA MAX	±9.83E-11
Output Voltage High (V _{OUT+3} -V _{OUT+4})	4V MIN	±1.17E-3V
Output Voltage High (V _{OUT+5} -V _{OUT+6})	3.4V MIN	±9.97E-4V
Output Voltage Low (V _{OUT-3} -V _{OUT-4})	25mV MAX	±1.38E-4V
Output Voltage Low (V _{OUT-5} -V _{OUT-6})	10mV MAX	±1.44E-4V
Output Voltage Low (V _{OUT-7} -V _{OUT-8})	350mV MAX	±9.97E-4V



Appendix D: Additional Data

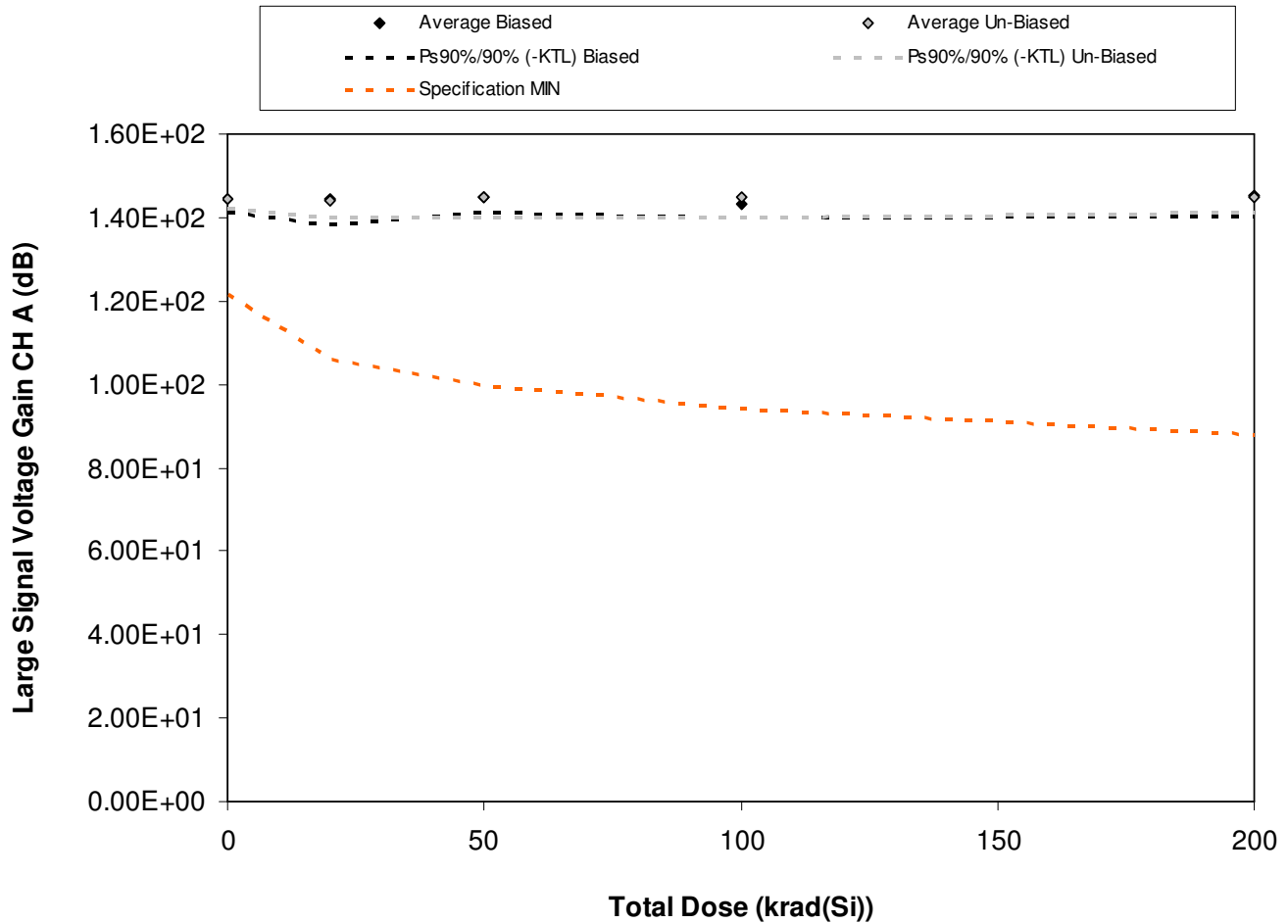

Figure D.1. Plot of open loop gain for channel A in dB versus total dose. The solid diamonds are the average of measured data points from the biased sample (devices irradiated with an electrical bias) while the shaded diamonds are the average from the un-biased sample. The black lines show the effects on the data after application of the biased KTL statistics (solid and/or dashed lines) while the gray lines show the effects on the data after application of the unbiased KTL statistics (solid and/or dashed lines). The red dashed lines are the minimum and/or maximum specification values as defined in the datasheet and/or test plan.



Table D.1. Raw data of the open loop gain for channel A in dB versus total dose, including the statistical analysis, the specification and the status of the testing (pass/fail).

Large Signal Voltage Gain CH A (dB)	Total Dose (krad(Si))				
	0	20	50	100	200
Device					
1090	1.45E+02	1.44E+02	1.46E+02	1.42E+02	1.45E+02
1092	1.46E+02	1.44E+02	1.46E+02	1.43E+02	1.43E+02
1093	1.44E+02	1.46E+02	1.43E+02	1.45E+02	1.45E+02
1094	1.44E+02	1.41E+02	1.45E+02	1.43E+02	1.48E+02
1095	1.43E+02	1.46E+02	1.44E+02	1.42E+02	1.45E+02
1096	1.44E+02	1.43E+02	1.45E+02	1.47E+02	1.47E+02
1097	1.44E+02	1.43E+02	1.44E+02	1.46E+02	1.44E+02
1098	1.45E+02	1.43E+02	1.46E+02	1.42E+02	1.44E+02
1099	1.44E+02	1.46E+02	1.47E+02	1.44E+02	1.45E+02
1100	1.46E+02	1.46E+02	1.42E+02	1.44E+02	1.45E+02
1106	1.47E+02	1.44E+02	1.45E+02	1.44E+02	1.44E+02
1113	1.44E+02	1.46E+02	1.45E+02	1.44E+02	1.42E+02
Biased Statistics					
Average Biased	1.44E+02	1.44E+02	1.45E+02	1.43E+02	1.45E+02
Std Dev Biased	1.12E+00	2.13E+00	1.33E+00	1.14E+00	1.87E+00
Ps90%/90% (+KTL) Biased	1.47E+02	1.50E+02	1.48E+02	1.46E+02	1.50E+02
Ps90%/90% (-KTL) Biased	1.41E+02	1.38E+02	1.41E+02	1.40E+02	1.40E+02
Un-Biased Statistics					
Average Un-Biased	1.45E+02	1.44E+02	1.45E+02	1.45E+02	1.45E+02
Std Dev Un-Biased	8.48E-01	1.59E+00	1.81E+00	1.70E+00	1.39E+00
Ps90%/90% (+KTL) Un-Biased	1.47E+02	1.49E+02	1.50E+02	1.49E+02	1.49E+02
Ps90%/90% (-KTL) Un-Biased	1.42E+02	1.40E+02	1.40E+02	1.40E+02	1.41E+02
Specification MIN	1.22E+02	1.06E+02	1.00E+02	9.40E+01	8.80E+01
Status	PASS	PASS	PASS	PASS	PASS

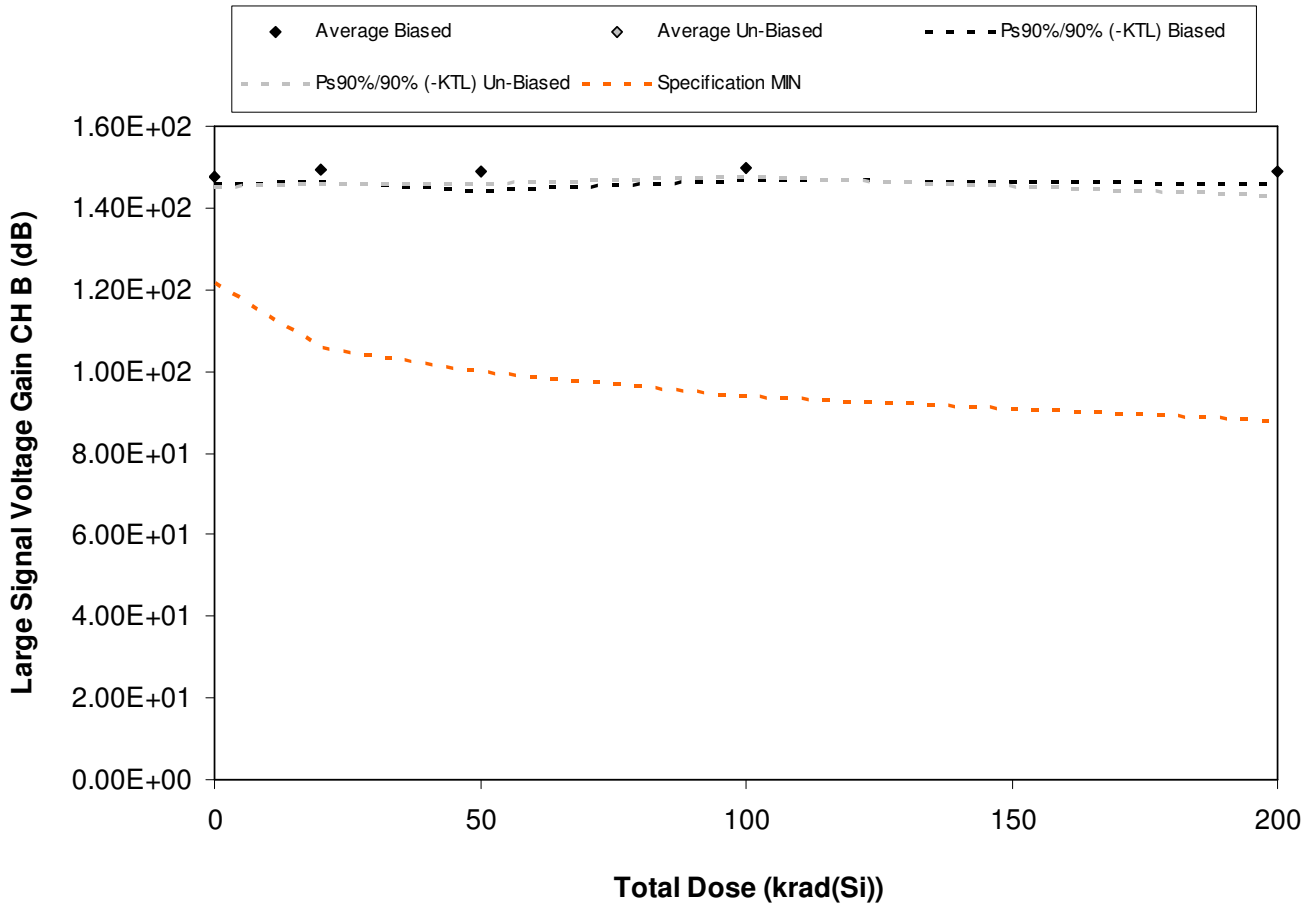

Figure D.2. Plot of open loop gain for channel B in dB versus total dose. The solid diamonds are the average of measured data points from the biased sample (devices irradiated with an electrical bias) while the shaded diamonds are the average from the un-biased sample. The black lines show the effects on the data after application of the biased KTL statistics (solid and/or dashed lines) while the gray lines show the effects on the data after application of the unbiased KTL statistics (solid and/or dashed lines). The red dashed lines are the minimum and/or maximum specification values as defined in the datasheet and/or test plan.



Table D.2. Raw data of the open loop gain for channel B in dB versus total dose, including the statistical analysis, the specification and the status of the testing (pass/fail).

Large Signal Voltage Gain CH B (dB)	Total Dose (krad(Si))				
	0	20	50	100	200
Device					
1090	1.48E+02	1.48E+02	1.49E+02	1.49E+02	1.49E+02
1092	1.48E+02	1.51E+02	1.47E+02	1.49E+02	1.50E+02
1093	1.48E+02	1.48E+02	1.51E+02	1.50E+02	1.50E+02
1094	1.47E+02	1.50E+02	1.48E+02	1.52E+02	1.50E+02
1095	1.47E+02	1.50E+02	1.49E+02	1.49E+02	1.47E+02
1096	1.48E+02	1.49E+02	1.48E+02	1.48E+02	1.49E+02
1097	1.50E+02	1.48E+02	1.49E+02	1.49E+02	1.49E+02
1098	1.49E+02	1.48E+02	1.50E+02	1.49E+02	1.46E+02
1099	1.47E+02	1.50E+02	1.48E+02	1.49E+02	1.47E+02
1100	1.48E+02	1.48E+02	1.50E+02	1.49E+02	1.46E+02
1106	1.48E+02	1.49E+02	1.50E+02	1.48E+02	1.50E+02
1113	1.46E+02	1.47E+02	1.48E+02	1.48E+02	1.50E+02
Biased Statistics					
Average Biased	1.48E+02	1.49E+02	1.49E+02	1.50E+02	1.49E+02
Std Dev Biased	5.43E-01	1.13E+00	1.62E+00	1.08E+00	1.16E+00
Ps90%/90% (+KTL) Biased	1.49E+02	1.53E+02	1.53E+02	1.53E+02	1.52E+02
Ps90%/90% (-KTL) Biased	1.46E+02	1.46E+02	1.44E+02	1.47E+02	1.46E+02
Un-Biased Statistics					
Average Un-Biased	1.48E+02	1.49E+02	1.49E+02	1.49E+02	1.47E+02
Std Dev Un-Biased	1.14E+00	1.03E+00	1.04E+00	3.59E-01	1.52E+00
Ps90%/90% (+KTL) Un-Biased	1.51E+02	1.51E+02	1.52E+02	1.50E+02	1.51E+02
Ps90%/90% (-KTL) Un-Biased	1.45E+02	1.46E+02	1.46E+02	1.48E+02	1.43E+02
Specification MIN	1.22E+02	1.06E+02	1.00E+02	9.40E+01	8.80E+01
Status	PASS	PASS	PASS	PASS	PASS