



**ELDRS Report  
12-979 130327 R1.0**

**Aeroflex RAD  
5017 N. 30th Street  
Colorado Springs, CO 80919  
(719) 531-0800**

**Products contained in this shipment may be subject to ITAR regulations.**

**Warning:**

The export of these commodity(ies), technology, or software are subject either to the U.S. Commerce Department Export Administration Regulations (E.A.R.), or to the U.S. State Department International Traffic In Arms Regulations (I.T.A.R.). Diversion, the shipment to unauthorized locations or entities, or the disclosure of related technical data or software to unauthorized foreign nationals is contrary to U.S. law and is prohibited. If export is authorized to a specific country or end-users, compliance with the U.S. export laws is required prior to transfer, transshipment on a non-continuous voyage, or disposal in any other country, or to any other end-user of these commodities, either in their original form or after being incorporated into other end-items.



## ***Enhanced Low Dose Rate Sensitivity (ELDRS) Radiation Testing of the RH117K Positive Adjustable Regulator for Linear Technology***

**Customer:** Linear Technology, PO# 7217J

**RAD Job Number:** 12-979

**Part Type Tested:** RH117K Positive Adjustable Regulator, Linear Technology RH117 Datasheet Revision B

**Traceability Information:** Fab Lot Number: W0944174.1, Assembly Lot Number: 660845.1, Wafer Number: 7, Date Code: 1210A See photograph of unit under test in Appendix A.

**Quantity of Units:** 11 units received, 5 units for biased irradiation, 5 units for unbiased irradiation and 1 unit for control. Serial numbers 2, 6, 7, 8 and 10 were biased during irradiation, serial numbers 11, 14, 17, 19 and 20 were unbiased during irradiation and serial number 51 was used as control. See Appendix B for the radiation bias connection table.

**Radiation and Electrical Test Increments:** 10mrad(Si)/s ionizing radiation with electrical test increments: pre-irradiation, 10krad(Si), 20krad(Si), 30krad(Si) and 50krad(Si).

**Pre-Irradiation Burn-In:** Burn-In performed by Linear Technology prior to receipt by RAD

**Overtest and Post-Irradiation Anneal:** No overtest. 24-hour room temperature anneal followed by a 168-hour 100°C anneal. Both anneals were performed in the same electrical bias condition as the irradiations. Electrical measurements were made following each anneal increment.

**Radiation Test Standard:** MIL-STD-750E TM1019 and/or MIL-STD-883H TM1019 Condition D and Linear Technology Linear Technology RH117 Datasheet Revision B.

**Test Hardware and Software:** LTS2020 Automated Tester, Entity ID TS04, Calibration Date: 4/26/2012, Calibration Due: 4/26/2013. LTS2101 Family Board, Entity ID FB02. LTS0606A Test Fixture, Entity ID TF35. RH117K DUT Board. Test Program: RH117LTK.SRC

**Facility and Radiation Source:** Aeroflex RAD's Longmire Laboratories, Colorado Springs, CO. Gamma rays provided by Co60 (GB-150) low dose rate source. Dosimetry performed by Air Ionization Chamber (AIC) traceable to NIST. Aeroflex RAD's dosimetry has been audited by DSCC and Aeroflex RAD has been awarded Laboratory Suitability for MIL-STD-750 and MIL-STD-883 TM 1019.

**Irradiation and Test Temperature:** Room temperature controlled to 24°C±6°C per MIL-STD-883 and MIL-STD-750.

**Test Result: PASSED the enhanced low dose rate sensitivity test to the maximum tested dose level of 50krad(Si) with all parameters remaining within their datasheet specifications.**



## **1.0. Overview and Background**

It is well known that total dose ionizing radiation can cause parametric degradation and ultimately functional failure in electronic devices. The damage occurs via electron-hole pair production, transport and trapping in the dielectric regions. In advanced CMOS technology nodes (0.6 $\mu$ m and smaller) the bulk of the damage is manifested in the thicker isolation regions, such as shallow trench or local oxidation of silicon (LOCOS) oxides (also known as "birds-beak" oxides). However, many linear and mixed signal devices that utilize bipolar minority carrier elements exhibit an enhanced low dose rate sensitivity (ELDRS). At this time there is no known or accepted *a priori* method for predicting susceptibility to ELDRS or simulating the low dose rate sensitivity with a "conventional" room temperature 50-300rad(Si)/s irradiation (Condition A in MIL-STD-883 TM 1019.8). Over the past 10 years a number of accelerating techniques have been examined, including an elevated temperature anneal, such as that used for MOS devices (see ASTM-F-1892 for more technical details) and irradiating at various temperatures. However, none of these techniques have proven useful across the wide variety of linear and/or mixed signal devices used in spaceborne applications.

The latest requirement incorporated in MIL-STD-883 TM 1019 requires that devices that could potentially exhibit ELDRS "shall be tested either at the intended application dose rate, at a prescribed low dose rate to an overtest radiation level, or with an accelerated test such as an elevated temperature irradiation test that includes a parameter delta design margin". While the recently released MIL-STD-883 TM 1019 allows for accelerated testing, the requirements for this are to essentially perform a low dose rate ELDRS test to verify the suitability of the acceleration method on the component of interest before the acceleration technique can be instituted. Based on the limitations of accelerated testing and to meet the requirements of MIL-STD-883 TM1019.8 Condition D, we have performed a low dose rate test at 10mrad(Si)/s.

## **2.0. Radiation Test Apparatus**

The low dose rate testing described in this final report was performed using the facilities at Aeroflex RAD's Longmire Laboratories in Colorado Springs, CO. The low dose rate source is a GB-150 irradiator modified to provide a panoramic exposure. The Co-60 rods are held in the base of the irradiator heavily shielded by lead. During the irradiation exposures the rod is raised by an electronic timer/controller and the exposure is performed in air. The dose rate for this irradiator in this configuration ranges from approximately 1mrad(Si)/s to a maximum of approximately 50rad(Si)/s, determined by the distance from the source. For low dose rate testing described in this report, the devices are placed approximately 2-meters from the Co-60 rods. The irradiator calibration is maintained by Aeroflex RAD's Longmire Laboratories using air ionization chamber (AIC) dosimetry traceable to the National Institute of Standards and Technology (NIST). Figure 2.1 shows a photograph of the GB-150 Co-60 irradiator at Aeroflex RAD's Longmire Laboratory facility.



Figure 2.1. Aeroflex RAD's Co-60 irradiator. The dose rate is obtained by positioning the device-under-test at a fixed distance from the gamma cell. The dose rate for this irradiator varies from approximately 50rad(Si)/s close to the rods down to <1mrad(Si)/s at a distance of approximately 4-meters.



### **3.0. Radiation Test Conditions**

The RH117K Positive Adjustable Regulator described in this final report were irradiated using a split 15V supply and with all pins tied to ground, that is biased and unbiased. See Appendix B for details on the biasing conditions during radiation exposure. In our opinion, this bias circuit satisfies the requirements of MIL-STD-883H TM1019.8 Section 3.9.3 Bias and Loading Conditions which states "The bias applied to the test devices shall be selected to produce the greatest radiation induced damage or the worst-case damage for the intended application, if known. While maximum voltage is often worst case some bipolar linear device parameters (e.g. input bias current or maximum output load current) exhibit more degradation with 0 V bias."

The devices were irradiated to a maximum total ionizing dose level of 50krad(Si) with incremental readings at 10krad(Si), 20krad(Si) and 30krad(Si). Electrical testing occurred within one hour following the end of each irradiation segment. For intermediate irradiations, the units were tested and returned to total dose exposure within two hours from the end of the previous radiation increment. The radiation exposure bias board was positioned in the Co-60 cell to provide the targeted dose rate of 10mrad(Si)/s and was located inside a lead-aluminum enclosure. The lead-aluminum enclosure is required under MIL-STD-883H TM1019.8 Section 3.4 that reads as follows: "Lead/Aluminum (Pb/Al) container. Test specimens shall be enclosed in a Pb/Al container to minimize dose enhancement effects caused by low-energy, scattered radiation. A minimum of 1.5 mm Pb, surrounding an inner shield of at least 0.7 mm Al, is required. This Pb/Al container produces an approximate charged particle equilibrium for Si and for TLDs such as CaF<sub>2</sub>. The radiation field intensity shall be measured inside the Pb/Al container (1) initially, (2) when the source is changed, or (3) when the orientation or configuration of the source, container, or test-fixture is changed. This measurement shall be performed by placing a dosimeter (e.g., a TLD) in the device-irradiation container at the approximate test-device position. If it can be demonstrated that low energy scattered radiation is small enough that it will not cause dosimetry errors due to dose enhancement, the Pb/Al container may be omitted".

The final dose rate within the lead-aluminum box was determined based on air ionization chamber (AIC) dosimetry measurements just prior to the beginning of the total dose irradiations. The final dose rate for this work was 10mrad(Si)/s with a precision of  $\pm 5\%$ .



#### **4.0. Tested Parameters**

During the enhanced low dose rate sensitivity testing the following electrical parameters were measured pre- and post-irradiation:

1. Reference Voltage 1 (V) @ VDIF=3V, IL=10mA
2. Reference Voltage 2 (V) @ VDIF=40V, IL=10mA
3. Reference Voltage 3 (V) @ VDIF=3V, IL=1.5A
4. Reference Voltage 4 (V) @ VDIF=40V, IL=0.3A
5. Line Regulation (%/V) @ VDIF=3V TO 40V, IL=10mA
6. Load Regulation 1 (V) @ VOUT<=5V, IL=10mA TO 1.5A
7. Load Regulation 2 (%) @ VOUT>=5V, IL=10mA TO 1.5A
8. Adjust Pin Current 1 (A) @ VDIF=2.5V, IL=10mA
9. Adjust Pin Current 2 (A) @ VDIF=5V, IL=10mA
10. Adjust Pin Current 3 (A) @ VDIF=40V, IL=10mA
11. Adjust Pin Current Change 1 (A) @ VDIF=5V, IL=10mA TO 1.5A
12. Adjust Pin Current Change 2 (A) @ VDIF=2.5V TO 40V, IL=10mA
13. Minimum Load Current (A) @ VDIF=40V
14. Current Limit 1 (A) @ VIN-VOUT=15V
15. Current Limit 2 (A) @ VIN-VOUT=40V

Appendix C details the measured parameters, test conditions, pre-irradiation specification and measurement resolution for each of the measurements.

The parametric data was obtained as "read and record" and all the raw data plus an attributes summary are contained in this report as well as in a separate Excel file. The attributes data contains the average, standard deviation and the average with the KTL values applied. The KTL value used in this work is 2.742 per MIL-HDBK-814 using one sided tolerance limits of 90/90 and a 5-piece sample size. The 90/90 KTL values were selected to match the statistical levels specified in the MIL-PRF-38535 sampling plan for the qualification of a radiation hardness assured (RHA) component. Note that the following criteria must be met for a device to pass the low dose rate test: following the radiation exposure each of the 5 pieces irradiated under electrical bias shall pass the specification value. The units irradiated without electrical bias and the KTL statistics are included in this report for reference only. If any of the 5 pieces irradiated under electrical bias exceed the device post radiation data sheet specification limits, then the lot could be logged as a failure.



### **5.0. ELDRS Test Results**

Based on this criterion the RH117K Positive Adjustable Regulator (from the lot traceability information provided on the first page of this test report) PASSED the enhanced low dose rate sensitivity test to the maximum tested dose level of 50krad(Si) with all parameters remaining within their datasheet specifications.

Figures 5.1 through 5.15 show plots of all the measured parameters versus total ionizing dose while Tables 5.1 - 5.15 show the corresponding raw data for each of these parameters. In the data plots the solid diamonds are the average of the measured data points for the sample irradiated under electrical bias while the shaded diamonds are the average of the measured data points for the units irradiated with all pins tied to ground. The black lines (solid or dashed) are the average of the data points after application of the KTL statistics on the sample irradiated in the biased condition while the shaded lines (solid or dashed) are the average of the data points after application of the KTL statistics on the sample irradiated in the unbiased condition. The red dotted line(s) are the pre- and/or post-irradiation minimum and/or maximum specification value as defined in the datasheet and/or test plan.

In addition to the radiation test results, the data plots and tables described above contain anneal data. The anneals are performed to better understand the underlying physical mechanisms responsible for radiation-induced parametric shifts and are not part of the criteria used to establish whether or not the lot passes or fails the low dose rate test. In all cases the parts either improved or exhibited no change during the anneal.

The control units, as expected, show no significant changes to any of the parameters. Therefore we can conclude that the electrical testing remained in control throughout the duration of the tests and the observed degradation was due to the radiation exposure. Appendix D lists the figures used in this section to facilitate the location of a particular parameter.

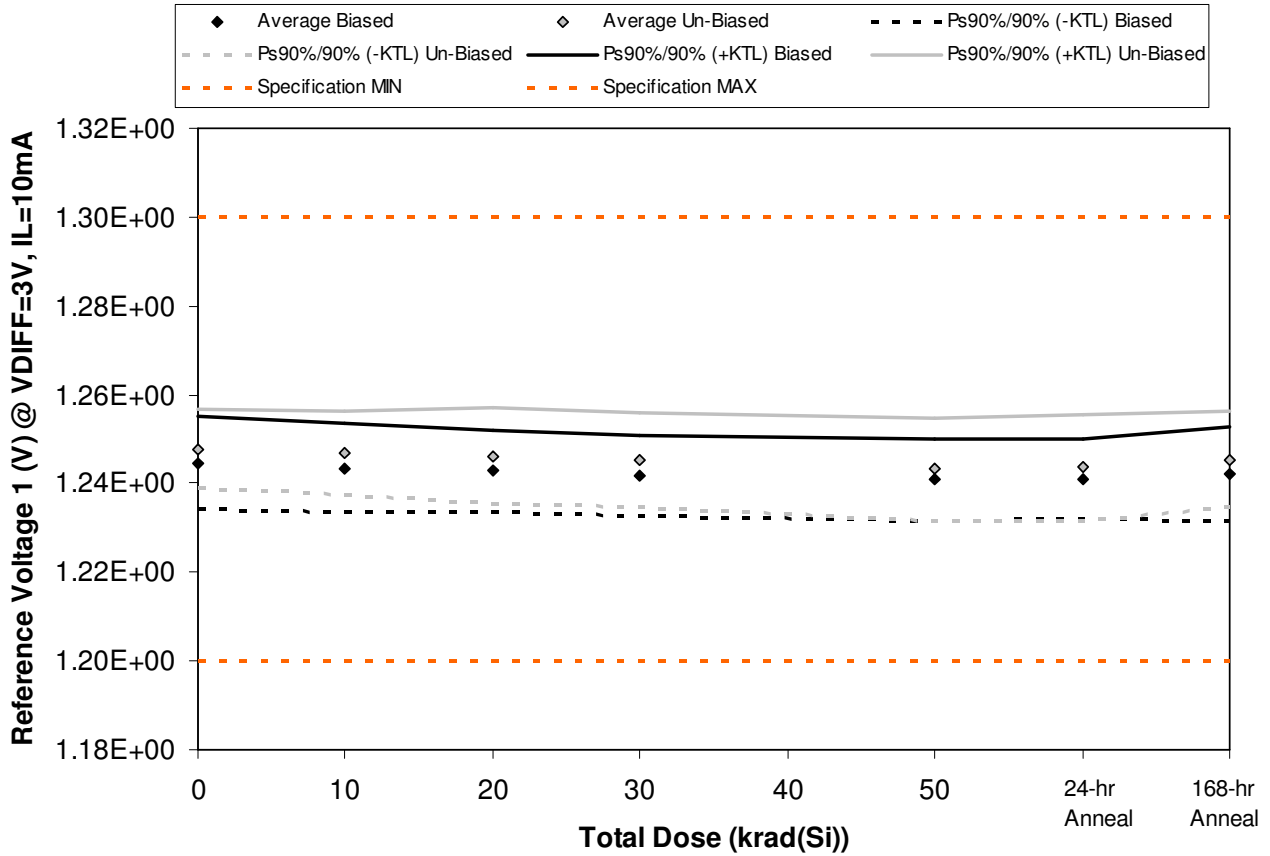

Figure 5.1. Plot of Reference Voltage 1 (V) @ VDIFF=3V, IL=10mA versus total dose. The solid diamonds are the average of the measured data points for the samples irradiated under electrical bias while the shaded diamonds are the average of the measured data points for the samples irradiated with all pins tied to ground. The black lines (solid and/or dashed) are the average of the data points after application of the KTL statistics on the samples irradiated under electrical bias while the gray lines (solid and/or dashed) are the average of the data points after application of the KTL statistics on the samples irradiated in the unbiased condition. The red dotted line(s) are the pre- and/or post-irradiation minimum and/or maximum specification value as defined in the datasheet and/or test plan.





**ELDRS Report  
12-979 130327 R1.0**

**Aeroflex RAD  
5017 N. 30th Street  
Colorado Springs, CO 80919  
(719) 531-0800**

Table 5.1. Raw data for Reference Voltage 1 (V) @ VDIFF=3V, IL=10mA versus total dose, including the statistical analysis, specification and the status of the testing (pass/fail).

Reference Voltage 1 (V) @ VDIFF=3V, IL=10mA	Total Dose (krad(Si))					24-hr Anneal	168-hr Anneal
	0	10	20	30	50		
Device							
2	1.24E+00	1.24E+00	1.24E+00	1.24E+00	1.24E+00	1.24E+00	1.24E+00
6	1.24E+00	1.24E+00	1.24E+00	1.24E+00	1.24E+00	1.24E+00	1.24E+00
7	1.25E+00	1.25E+00	1.24E+00	1.24E+00	1.24E+00	1.24E+00	1.24E+00
8	1.24E+00	1.24E+00	1.24E+00	1.24E+00	1.24E+00	1.24E+00	1.24E+00
10	1.25E+00	1.25E+00	1.25E+00	1.25E+00	1.25E+00	1.25E+00	1.25E+00
11	1.25E+00	1.25E+00	1.25E+00	1.25E+00	1.25E+00	1.25E+00	1.25E+00
14	1.25E+00	1.25E+00	1.25E+00	1.25E+00	1.25E+00	1.25E+00	1.25E+00
17	1.24E+00	1.24E+00	1.24E+00	1.24E+00	1.24E+00	1.24E+00	1.24E+00
19	1.25E+00	1.25E+00	1.24E+00	1.24E+00	1.24E+00	1.24E+00	1.24E+00
20	1.25E+00	1.25E+00	1.25E+00	1.25E+00	1.24E+00	1.24E+00	1.25E+00
51	1.25E+00	1.25E+00	1.25E+00	1.25E+00	1.25E+00	1.25E+00	1.25E+00
<b>Biased Statistics</b>							
Average Biased	1.24E+00	1.24E+00	1.24E+00	1.24E+00	1.24E+00	1.24E+00	1.24E+00
Std Dev Biased	3.78E-03	3.65E-03	3.35E-03	3.35E-03	3.35E-03	3.32E-03	3.83E-03
Ps90%/90% (+KTL) Biased	1.25E+00	1.25E+00	1.25E+00	1.25E+00	1.25E+00	1.25E+00	1.25E+00
Ps90%/90% (-KTL) Biased	1.23E+00	1.23E+00	1.23E+00	1.23E+00	1.23E+00	1.23E+00	1.23E+00
<b>Un-Biased Statistics</b>							
Average Un-Biased	1.25E+00	1.25E+00	1.25E+00	1.25E+00	1.24E+00	1.24E+00	1.25E+00
Std Dev Un-Biased	3.27E-03	3.42E-03	3.90E-03	3.90E-03	4.21E-03	4.39E-03	3.91E-03
Ps90%/90% (+KTL) Un-Biased	1.26E+00	1.26E+00	1.26E+00	1.26E+00	1.25E+00	1.26E+00	1.26E+00
Ps90%/90% (-KTL) Un-Biased	1.24E+00	1.24E+00	1.24E+00	1.23E+00	1.23E+00	1.23E+00	1.23E+00
<b>Specification MIN</b>	<b>1.20E+00</b>	<b>1.20E+00</b>	<b>1.20E+00</b>	<b>1.20E+00</b>	<b>1.20E+00</b>	<b>1.20E+00</b>	<b>1.20E+00</b>
Status	PASS	PASS	PASS	PASS	PASS	PASS	PASS
<b>Specification MAX</b>	<b>1.30E+00</b>	<b>1.30E+00</b>	<b>1.30E+00</b>	<b>1.30E+00</b>	<b>1.30E+00</b>	<b>1.30E+00</b>	<b>1.30E+00</b>
Status	PASS	PASS	PASS	PASS	PASS	PASS	PASS

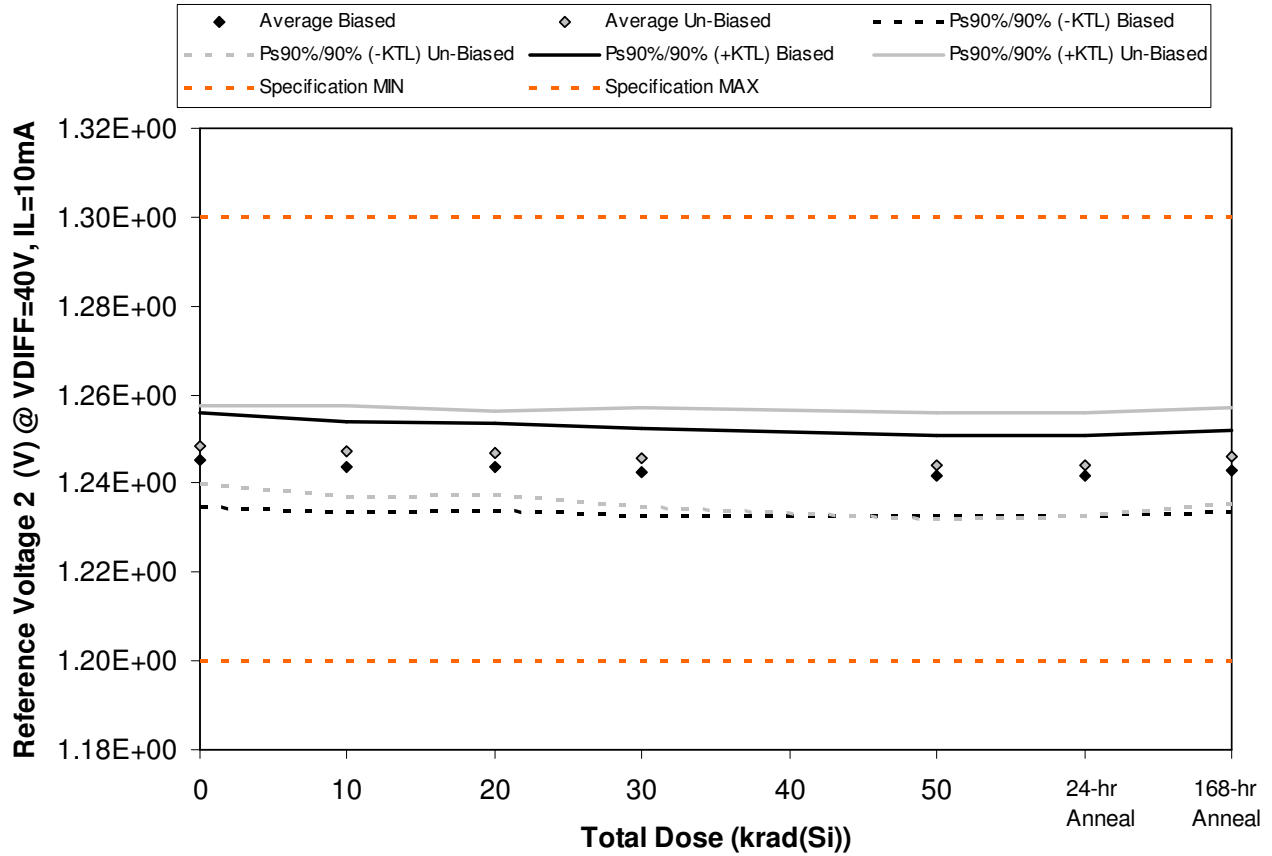

Figure 5.2. Plot of Reference Voltage 2 (V) @ VDIF=40V, IL=10mA versus total dose. The solid diamonds are the average of the measured data points for the samples irradiated under electrical bias while the shaded diamonds are the average of the measured data points for the samples irradiated with all pins tied to ground. The black lines (solid and/or dashed) are the average of the data points after application of the KTL statistics on the samples irradiated under electrical bias while the gray lines (solid and/or dashed) are the average of the data points after application of the KTL statistics on the samples irradiated in the unbiased condition. The red dotted line(s) are the pre- and/or post-irradiation minimum and/or maximum specification value as defined in the datasheet and/or test plan.



**ELDRS Report  
12-979 130327 R1.0**

**Aeroflex RAD  
5017 N. 30th Street  
Colorado Springs, CO 80919  
(719) 531-0800**

Table 5.2. Raw data for Reference Voltage 2 (V) @ VDIFF=40V, IL=10mA versus total dose, including the statistical analysis, specification and the status of the testing (pass/fail).

Reference Voltage 2 (V) @ VDIFF=40V, IL=10mA	Total Dose (krad(Si))					24-hr Anneal	168-hr Anneal
	0	10	20	30	50		
Device							
2	1.24E+00	1.24E+00	1.24E+00	1.24E+00	1.24E+00	1.24E+00	1.24E+00
6	1.24E+00	1.24E+00	1.24E+00	1.24E+00	1.24E+00	1.24E+00	1.24E+00
7	1.25E+00	1.25E+00	1.25E+00	1.24E+00	1.24E+00	1.24E+00	1.24E+00
8	1.24E+00	1.24E+00	1.24E+00	1.24E+00	1.24E+00	1.24E+00	1.24E+00
10	1.25E+00	1.25E+00	1.25E+00	1.25E+00	1.25E+00	1.25E+00	1.25E+00
11	1.25E+00	1.25E+00	1.25E+00	1.25E+00	1.25E+00	1.25E+00	1.25E+00
14	1.25E+00	1.25E+00	1.25E+00	1.25E+00	1.25E+00	1.25E+00	1.25E+00
17	1.24E+00	1.24E+00	1.24E+00	1.24E+00	1.24E+00	1.24E+00	1.24E+00
19	1.25E+00	1.25E+00	1.25E+00	1.24E+00	1.24E+00	1.24E+00	1.24E+00
20	1.25E+00	1.25E+00	1.25E+00	1.25E+00	1.24E+00	1.24E+00	1.25E+00
51	1.25E+00	1.25E+00	1.25E+00	1.25E+00	1.25E+00	1.25E+00	1.25E+00
<b>Biased Statistics</b>							
Average Biased	1.25E+00	1.24E+00	1.24E+00	1.24E+00	1.24E+00	1.24E+00	1.24E+00
Std Dev Biased	3.90E-03	3.70E-03	3.58E-03	3.58E-03	3.29E-03	3.35E-03	3.35E-03
Ps90%/90% (+KTL) Biased	1.26E+00	1.25E+00	1.25E+00	1.25E+00	1.25E+00	1.25E+00	1.25E+00
Ps90%/90% (-KTL) Biased	1.23E+00	1.23E+00	1.23E+00	1.23E+00	1.23E+00	1.23E+00	1.23E+00
<b>Un-Biased Statistics</b>							
Average Un-Biased	1.25E+00	1.25E+00	1.25E+00	1.25E+00	1.24E+00	1.24E+00	1.25E+00
Std Dev Un-Biased	3.21E-03	3.70E-03	3.42E-03	4.09E-03	4.36E-03	4.21E-03	3.90E-03
Ps90%/90% (+KTL) Un-Biased	1.26E+00	1.26E+00	1.26E+00	1.26E+00	1.26E+00	1.26E+00	1.26E+00
Ps90%/90% (-KTL) Un-Biased	1.24E+00	1.24E+00	1.24E+00	1.23E+00	1.23E+00	1.23E+00	1.24E+00
<b>Specification MIN</b>	<b>1.20E+00</b>	<b>1.20E+00</b>	<b>1.20E+00</b>	<b>1.20E+00</b>	<b>1.20E+00</b>	<b>1.20E+00</b>	<b>1.20E+00</b>
Status	PASS	PASS	PASS	PASS	PASS	PASS	PASS
<b>Specification MAX</b>	<b>1.30E+00</b>	<b>1.30E+00</b>	<b>1.30E+00</b>	<b>1.30E+00</b>	<b>1.30E+00</b>	<b>1.30E+00</b>	<b>1.30E+00</b>
Status	PASS	PASS	PASS	PASS	PASS	PASS	PASS

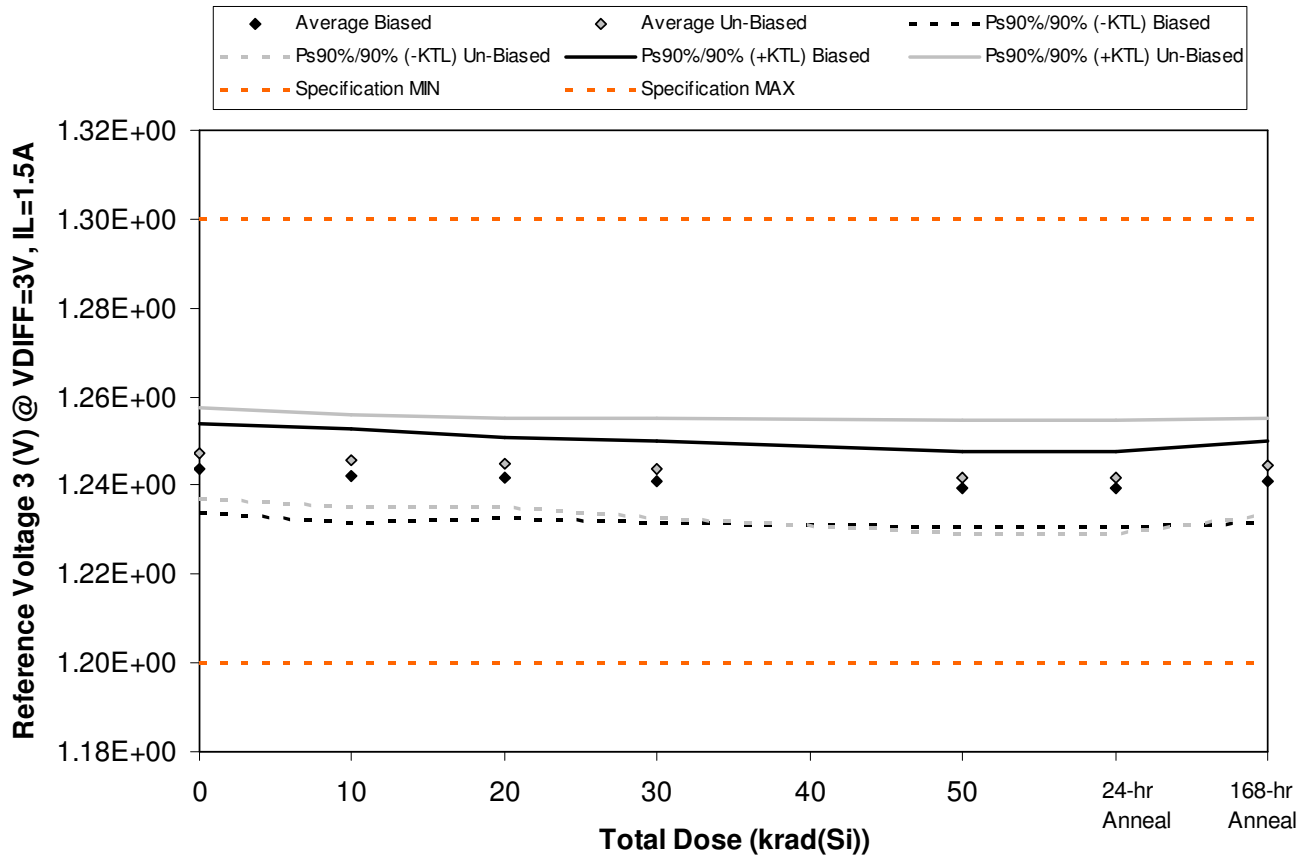

Figure 5.3. Plot of Reference Voltage 3 (V) @ VDIFF=3V, IL=1.5A versus total dose. The solid diamonds are the average of the measured data points for the samples irradiated under electrical bias while the shaded diamonds are the average of the measured data points for the samples irradiated with all pins tied to ground. The black lines (solid and/or dashed) are the average of the data points after application of the KTL statistics on the samples irradiated under electrical bias while the gray lines (solid and/or dashed) are the average of the data points after application of the KTL statistics on the samples irradiated in the unbiased condition. The red dotted line(s) are the pre- and/or post-irradiation minimum and/or maximum specification value as defined in the datasheet and/or test plan.



**ELDRS Report  
12-979 130327 R1.0**

**Aeroflex RAD  
5017 N. 30th Street  
Colorado Springs, CO 80919  
(719) 531-0800**

Table 5.3. Raw data for Reference Voltage 3 (V) @ VDIFF=3V, IL=1.5A versus total dose, including the statistical analysis, specification and the status of the testing (pass/fail).

Reference Voltage 3 (V) @ VDIFF=3V, IL=1.5A	Total Dose (krad(Si))					24-hr Anneal	168-hr Anneal
	0	10	20	30	50		
Device							
2	1.24E+00	1.24E+00	1.24E+00	1.24E+00	1.24E+00	1.24E+00	1.24E+00
6	1.24E+00	1.24E+00	1.24E+00	1.24E+00	1.24E+00	1.24E+00	1.24E+00
7	1.25E+00	1.24E+00	1.24E+00	1.24E+00	1.24E+00	1.24E+00	1.24E+00
8	1.24E+00	1.24E+00	1.24E+00	1.24E+00	1.24E+00	1.24E+00	1.24E+00
10	1.25E+00	1.25E+00	1.25E+00	1.25E+00	1.24E+00	1.24E+00	1.25E+00
11	1.25E+00	1.25E+00	1.25E+00	1.25E+00	1.25E+00	1.25E+00	1.25E+00
14	1.25E+00	1.25E+00	1.25E+00	1.25E+00	1.25E+00	1.25E+00	1.25E+00
17	1.24E+00	1.24E+00	1.24E+00	1.24E+00	1.24E+00	1.24E+00	1.24E+00
19	1.25E+00	1.24E+00	1.24E+00	1.24E+00	1.24E+00	1.24E+00	1.24E+00
20	1.25E+00	1.25E+00	1.25E+00	1.24E+00	1.24E+00	1.24E+00	1.25E+00
51	1.25E+00	1.25E+00	1.25E+00	1.25E+00	1.25E+00	1.25E+00	1.25E+00
<b>Biased Statistics</b>							
Average Biased	1.24E+00	1.24E+00	1.24E+00	1.24E+00	1.24E+00	1.24E+00	1.24E+00
Std Dev Biased	3.63E-03	3.83E-03	3.35E-03	3.35E-03	3.11E-03	3.11E-03	3.35E-03
Ps90%/90% (+KTL) Biased	1.25E+00	1.25E+00	1.25E+00	1.25E+00	1.25E+00	1.25E+00	1.25E+00
Ps90%/90% (-KTL) Biased	1.23E+00	1.23E+00	1.23E+00	1.23E+00	1.23E+00	1.23E+00	1.23E+00
<b>Un-Biased Statistics</b>							
Average Un-Biased	1.25E+00	1.25E+00	1.25E+00	1.24E+00	1.24E+00	1.24E+00	1.24E+00
Std Dev Un-Biased	3.70E-03	3.78E-03	3.67E-03	4.09E-03	4.66E-03	4.66E-03	3.91E-03
Ps90%/90% (+KTL) Un-Biased	1.26E+00	1.26E+00	1.26E+00	1.26E+00	1.25E+00	1.25E+00	1.26E+00
Ps90%/90% (-KTL) Un-Biased	1.24E+00	1.24E+00	1.23E+00	1.23E+00	1.23E+00	1.23E+00	1.23E+00
<b>Specification MIN</b>	<b>1.20E+00</b>	<b>1.20E+00</b>	<b>1.20E+00</b>	<b>1.20E+00</b>	<b>1.20E+00</b>	<b>1.20E+00</b>	<b>1.20E+00</b>
Status	PASS	PASS	PASS	PASS	PASS	PASS	PASS
<b>Specification MAX</b>	<b>1.30E+00</b>	<b>1.30E+00</b>	<b>1.30E+00</b>	<b>1.30E+00</b>	<b>1.30E+00</b>	<b>1.30E+00</b>	<b>1.30E+00</b>
Status	PASS	PASS	PASS	PASS	PASS	PASS	PASS

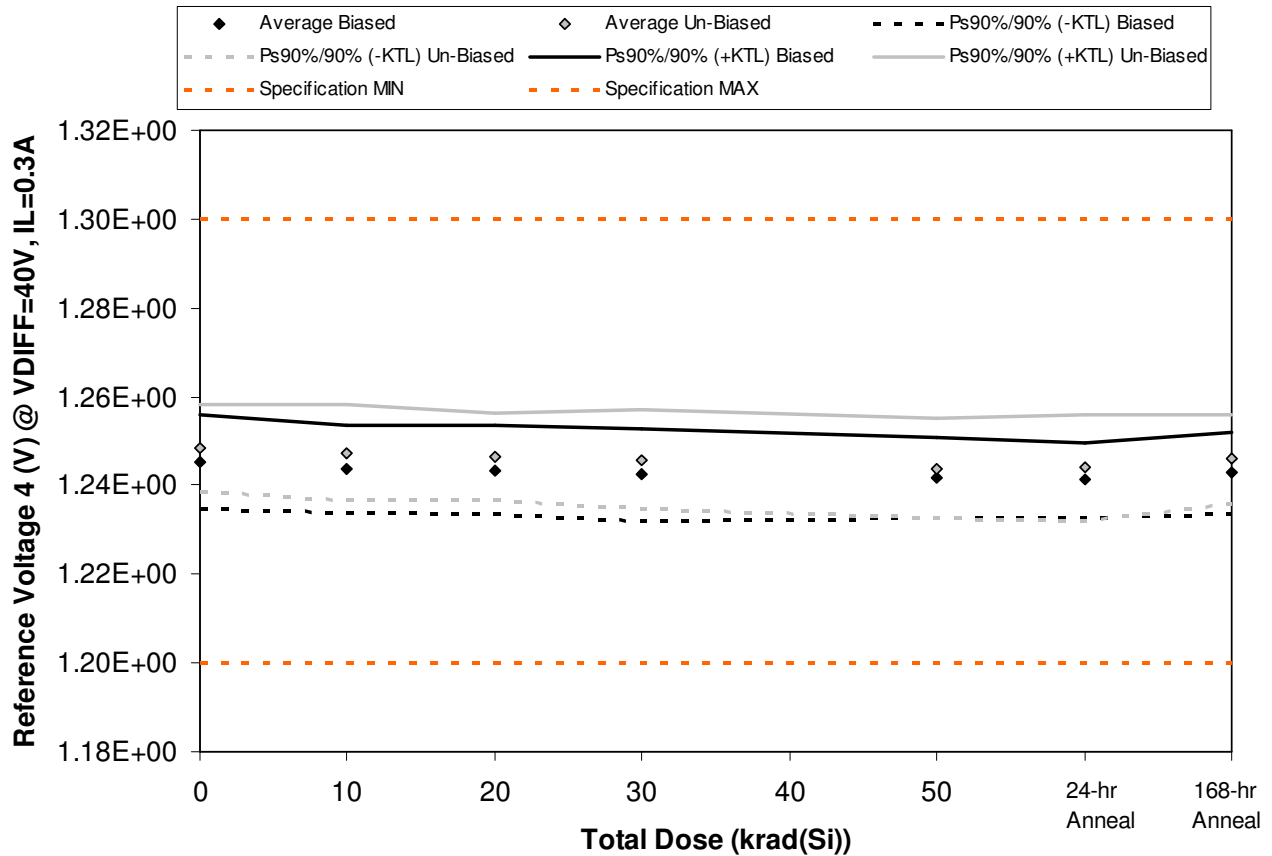

Figure 5.4. Plot of Reference Voltage 4 (V) @ VDIFF=40V, IL=0.3A versus total dose. The solid diamonds are the average of the measured data points for the samples irradiated under electrical bias while the shaded diamonds are the average of the measured data points for the samples irradiated with all pins tied to ground. The black lines (solid and/or dashed) are the average of the data points after application of the KTL statistics on the samples irradiated under electrical bias while the gray lines (solid and/or dashed) are the average of the data points after application of the KTL statistics on the samples irradiated in the unbiased condition. The red dotted line(s) are the pre- and/or post-irradiation minimum and/or maximum specification value as defined in the datasheet and/or test plan.



**ELDRS Report  
12-979 130327 R1.0**

**Aeroflex RAD  
5017 N. 30th Street  
Colorado Springs, CO 80919  
(719) 531-0800**

Table 5.4. Raw data for Reference Voltage 4 (V) @ VDIFF=40V, IL=0.3A versus total dose, including the statistical analysis, specification and the status of the testing (pass/fail).

Reference Voltage 4 (V) @ VDIFF=40V, IL=0.3A	Total Dose (krad(Si))					24-hr Anneal	168-hr Anneal
	0	10	20	30	50		
Device							
2	1.24E+00	1.24E+00	1.24E+00	1.24E+00	1.24E+00	1.24E+00	1.24E+00
6	1.24E+00	1.24E+00	1.24E+00	1.24E+00	1.24E+00	1.24E+00	1.24E+00
7	1.25E+00	1.25E+00	1.25E+00	1.24E+00	1.24E+00	1.24E+00	1.24E+00
8	1.24E+00	1.24E+00	1.24E+00	1.24E+00	1.24E+00	1.24E+00	1.24E+00
10	1.25E+00	1.25E+00	1.25E+00	1.25E+00	1.25E+00	1.25E+00	1.25E+00
11	1.25E+00	1.25E+00	1.25E+00	1.25E+00	1.25E+00	1.25E+00	1.25E+00
14	1.25E+00	1.25E+00	1.25E+00	1.25E+00	1.25E+00	1.25E+00	1.25E+00
17	1.24E+00	1.24E+00	1.24E+00	1.24E+00	1.24E+00	1.24E+00	1.24E+00
19	1.25E+00	1.25E+00	1.24E+00	1.24E+00	1.24E+00	1.24E+00	1.24E+00
20	1.25E+00	1.25E+00	1.25E+00	1.25E+00	1.24E+00	1.24E+00	1.25E+00
51	1.25E+00	1.25E+00	1.25E+00	1.25E+00	1.25E+00	1.25E+00	1.25E+00
<b>Biased Statistics</b>							
Average Biased	1.25E+00	1.24E+00	1.24E+00	1.24E+00	1.24E+00	1.24E+00	1.24E+00
Std Dev Biased	3.90E-03	3.58E-03	3.65E-03	3.78E-03	3.29E-03	3.11E-03	3.35E-03
Ps90%/90% (+KTL) Biased	1.26E+00	1.25E+00	1.25E+00	1.25E+00	1.25E+00	1.25E+00	1.25E+00
Ps90%/90% (-KTL) Biased	1.23E+00	1.23E+00	1.23E+00	1.23E+00	1.23E+00	1.23E+00	1.23E+00
<b>Un-Biased Statistics</b>							
Average Un-Biased	1.25E+00	1.25E+00	1.25E+00	1.25E+00	1.24E+00	1.24E+00	1.25E+00
Std Dev Un-Biased	3.58E-03	3.91E-03	3.58E-03	4.09E-03	4.09E-03	4.36E-03	3.67E-03
Ps90%/90% (+KTL) Un-Biased	1.26E+00	1.26E+00	1.26E+00	1.26E+00	1.26E+00	1.26E+00	1.26E+00
Ps90%/90% (-KTL) Un-Biased	1.24E+00	1.24E+00	1.24E+00	1.23E+00	1.23E+00	1.23E+00	1.24E+00
<b>Specification MIN</b>	<b>1.20E+00</b>	<b>1.20E+00</b>	<b>1.20E+00</b>	<b>1.20E+00</b>	<b>1.20E+00</b>	<b>1.20E+00</b>	<b>1.20E+00</b>
Status	PASS	PASS	PASS	PASS	PASS	PASS	PASS
<b>Specification MAX</b>	<b>1.30E+00</b>	<b>1.30E+00</b>	<b>1.30E+00</b>	<b>1.30E+00</b>	<b>1.30E+00</b>	<b>1.30E+00</b>	<b>1.30E+00</b>
Status	PASS	PASS	PASS	PASS	PASS	PASS	PASS

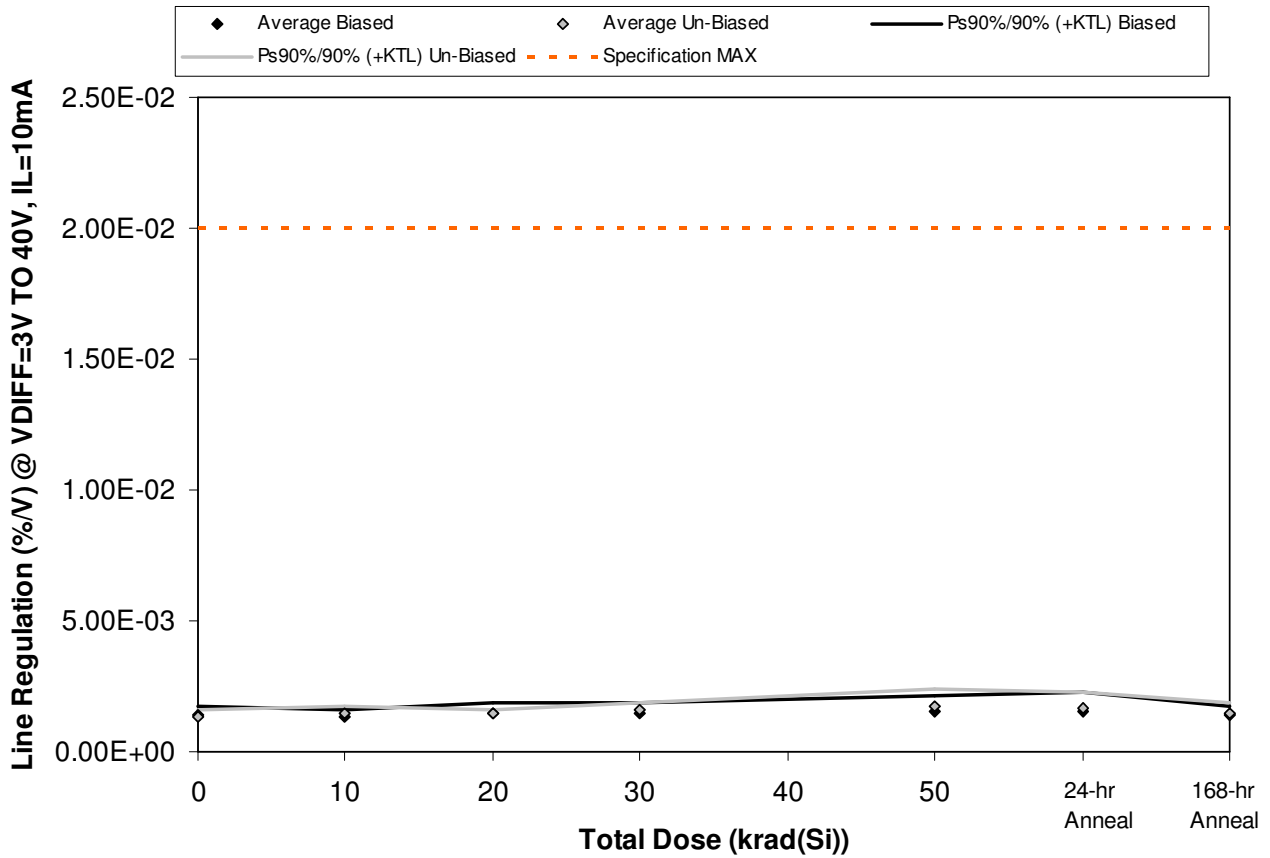

Figure 5.5. Plot of Line Regulation (%/V) @ VDIFF=3V TO 40V, IL=10mA versus total dose. The solid diamonds are the average of the measured data points for the samples irradiated under electrical bias while the shaded diamonds are the average of the measured data points for the samples irradiated with all pins tied to ground. The black lines (solid and/or dashed) are the average of the data points after application of the KTL statistics on the samples irradiated under electrical bias while the gray lines (solid and/or dashed) are the average of the data points after application of the KTL statistics on the samples irradiated in the unbiased condition. The red dotted line(s) are the pre- and/or post-irradiation minimum and/or maximum specification value as defined in the datasheet and/or test plan.





**ELDRS Report  
12-979 130327 R1.0**

**Aeroflex RAD  
5017 N. 30th Street  
Colorado Springs, CO 80919  
(719) 531-0800**

Table 5.5. Raw data for Line Regulation (%/V) @ VDIFF=3V TO 40V, IL=10mA versus total dose, including the statistical analysis, specification and the status of the testing (pass/fail).

Line Regulation (%/V) @ VDIFF=3V TO 40V, IL=10mA	Total Dose (krad(Si))					24-hr Anneal	168-hr Anneal
	0	10	20	30	50		
Device							
2	1.40E-03	1.20E-03	1.30E-03	1.40E-03	1.20E-03	1.20E-03	1.30E-03
6	1.40E-03	1.30E-03	1.50E-03	1.50E-03	1.60E-03	1.50E-03	1.40E-03
7	1.60E-03	1.50E-03	1.70E-03	1.70E-03	1.80E-03	1.90E-03	1.60E-03
8	1.30E-03	1.30E-03	1.40E-03	1.50E-03	1.50E-03	1.50E-03	1.40E-03
10	1.40E-03	1.30E-03	1.40E-03	1.40E-03	1.50E-03	1.70E-03	1.30E-03
11	1.30E-03	1.40E-03	1.40E-03	1.50E-03	1.40E-03	1.40E-03	1.30E-03
14	1.30E-03	1.30E-03	1.50E-03	1.50E-03	1.60E-03	1.60E-03	1.50E-03
17	1.30E-03	1.40E-03	1.40E-03	1.50E-03	1.60E-03	1.60E-03	1.50E-03
19	1.50E-03	1.60E-03	1.50E-03	1.70E-03	2.00E-03	1.90E-03	1.70E-03
20	1.40E-03	1.50E-03	1.50E-03	1.70E-03	1.90E-03	1.90E-03	1.50E-03
51	1.40E-03	1.50E-03	1.50E-03	1.30E-03	1.50E-03	1.30E-03	1.40E-03
<b>Biased Statistics</b>							
Average Biased	1.42E-03	1.32E-03	1.46E-03	1.50E-03	1.52E-03	1.56E-03	1.40E-03
Std Dev Biased	1.10E-04	1.10E-04	1.52E-04	1.22E-04	2.17E-04	2.61E-04	1.22E-04
Ps90%/90% (+KTL) Biased	1.72E-03	1.62E-03	1.88E-03	1.84E-03	2.11E-03	2.28E-03	1.74E-03
Ps90%/90% (-KTL) Biased	1.12E-03	1.02E-03	1.04E-03	1.16E-03	9.26E-04	8.45E-04	1.06E-03
<b>Un-Biased Statistics</b>							
Average Un-Biased	1.36E-03	1.44E-03	1.46E-03	1.58E-03	1.70E-03	1.68E-03	1.50E-03
Std Dev Un-Biased	8.94E-05	1.14E-04	5.48E-05	1.10E-04	2.45E-04	2.17E-04	1.41E-04
Ps90%/90% (+KTL) Un-Biased	1.61E-03	1.75E-03	1.61E-03	1.88E-03	2.37E-03	2.27E-03	1.89E-03
Ps90%/90% (-KTL) Un-Biased	1.11E-03	1.13E-03	1.31E-03	1.28E-03	1.03E-03	1.09E-03	1.11E-03
<b>Specification MAX</b>	<b>2.00E-02</b>	<b>2.00E-02</b>	<b>2.00E-02</b>	<b>2.00E-02</b>	<b>2.00E-02</b>	<b>2.00E-02</b>	<b>2.00E-02</b>
Status	PASS	PASS	PASS	PASS	PASS	PASS	PASS

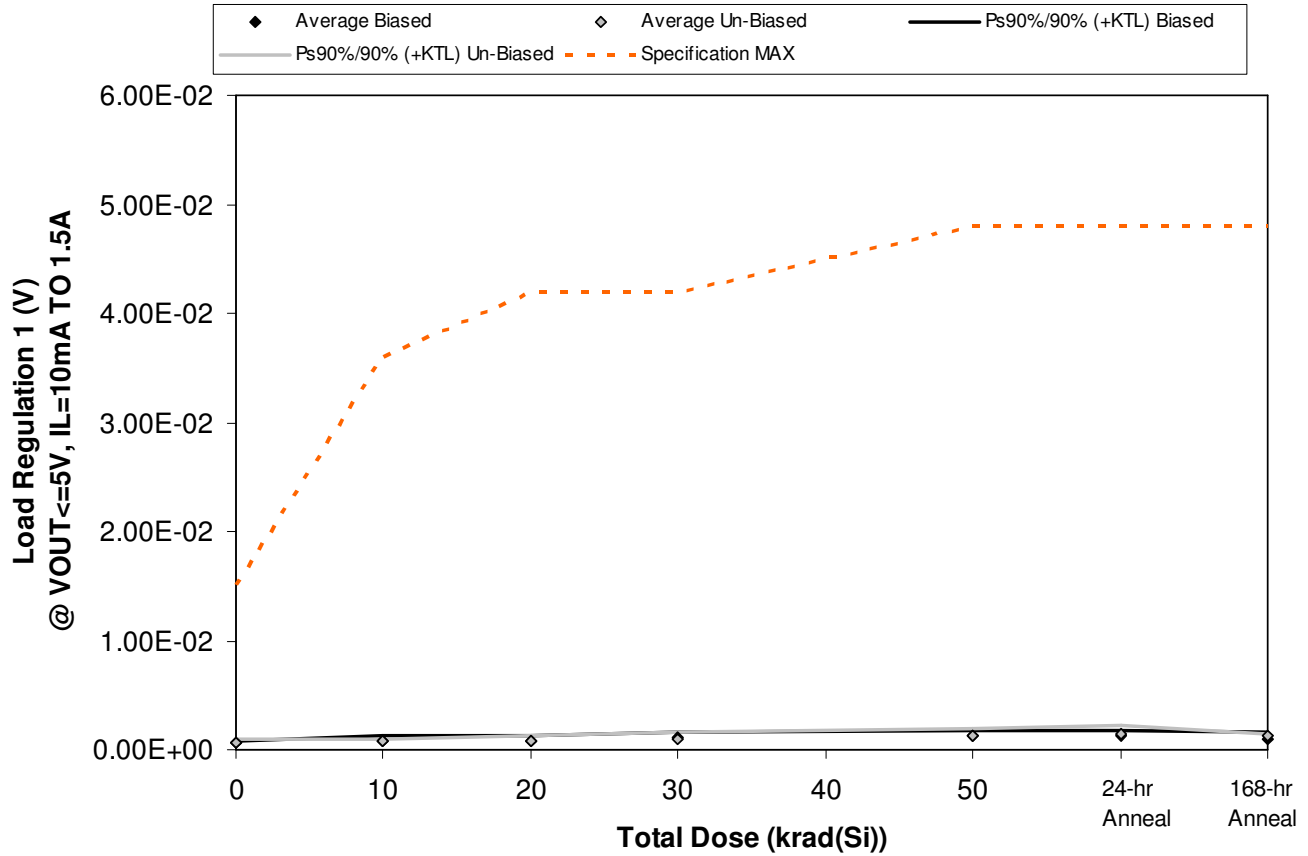

Figure 5.6. Plot of Load Regulation 1 (V) @  $V_{OUT} \leq 5V$ ,  $I_L = 10mA$  TO 1.5A versus total dose. The solid diamonds are the average of the measured data points for the samples irradiated under electrical bias while the shaded diamonds are the average of the measured data points for the samples irradiated with all pins tied to ground. The black lines (solid and/or dashed) are the average of the data points after application of the KTL statistics on the samples irradiated under electrical bias while the gray lines (solid and/or dashed) are the average of the data points after application of the KTL statistics on the samples irradiated in the unbiased condition. The red dotted line(s) are the pre- and/or post-irradiation minimum and/or maximum specification value as defined in the datasheet and/or test plan.



**ELDRS Report  
12-979 130327 R1.0**

**Aeroflex RAD  
5017 N. 30th Street  
Colorado Springs, CO 80919  
(719) 531-0800**

Table 5.6. Raw data for Load Regulation 1 (V) @ VOUT<=5V, IL=10mA TO 1.5A versus total dose, including the statistical analysis, specification and the status of the testing (pass/fail).

Load Regulation 1 (V) @ VOUT<=5V, IL=10mA TO 1.5A	Total Dose (krad(Si))					24-hr Anneal	168-hr Anneal
	0	10	20	30	50		
Device							
2	4.45E-04	8.30E-04	7.58E-04	8.84E-04	1.23E-03	1.04E-03	9.08E-04
6	6.69E-04	6.49E-04	9.04E-04	1.06E-03	1.16E-03	1.41E-03	1.27E-03
7	4.65E-04	6.01E-04	9.23E-04	1.26E-03	1.49E-03	1.47E-03	1.19E-03
8	6.35E-04	9.01E-04	5.71E-04	8.56E-04	1.02E-03	1.22E-03	7.31E-04
10	6.43E-04	9.60E-04	9.92E-04	1.23E-03	1.45E-03	1.27E-03	1.01E-03
11	7.53E-04	8.84E-04	6.82E-04	7.24E-04	9.95E-04	9.89E-04	1.08E-03
14	3.69E-04	6.57E-04	9.06E-04	9.43E-04	1.11E-03	1.45E-03	1.20E-03
17	7.06E-04	8.03E-04	6.25E-04	1.13E-03	1.09E-03	1.62E-03	1.16E-03
19	6.57E-04	7.51E-04	1.03E-03	1.16E-03	1.62E-03	1.70E-03	1.36E-03
20	6.23E-04	7.92E-04	8.84E-04	1.23E-03	1.44E-03	1.38E-03	1.29E-03
51	4.33E-04	8.07E-04	5.59E-04	5.74E-04	8.64E-04	6.40E-04	5.39E-04
<b>Biased Statistics</b>							
Average Biased	5.71E-04	7.88E-04	8.30E-04	1.06E-03	1.27E-03	1.28E-03	1.02E-03
Std Dev Biased	1.07E-04	1.57E-04	1.68E-04	1.88E-04	1.98E-04	1.68E-04	2.15E-04
Ps90%/90% (+KTL) Biased	8.65E-04	1.22E-03	1.29E-03	1.57E-03	1.81E-03	1.74E-03	1.61E-03
Ps90%/90% (-KTL) Biased	2.77E-04	3.58E-04	3.69E-04	5.43E-04	7.28E-04	8.22E-04	4.30E-04
<b>Un-Biased Statistics</b>							
Average Un-Biased	6.22E-04	7.77E-04	8.26E-04	1.04E-03	1.25E-03	1.43E-03	1.22E-03
Std Dev Un-Biased	1.50E-04	8.28E-05	1.69E-04	2.03E-04	2.67E-04	2.76E-04	1.08E-04
Ps90%/90% (+KTL) Un-Biased	1.03E-03	1.00E-03	1.29E-03	1.59E-03	1.98E-03	2.18E-03	1.51E-03
Ps90%/90% (-KTL) Un-Biased	2.12E-04	5.50E-04	3.63E-04	4.79E-04	5.18E-04	6.69E-04	9.23E-04
<b>Specification MAX</b>	<b>1.50E-02</b>	<b>3.60E-02</b>	<b>4.20E-02</b>	<b>4.20E-02</b>	<b>4.80E-02</b>	<b>4.80E-02</b>	<b>4.80E-02</b>
Status	PASS	PASS	PASS	PASS	PASS	PASS	PASS

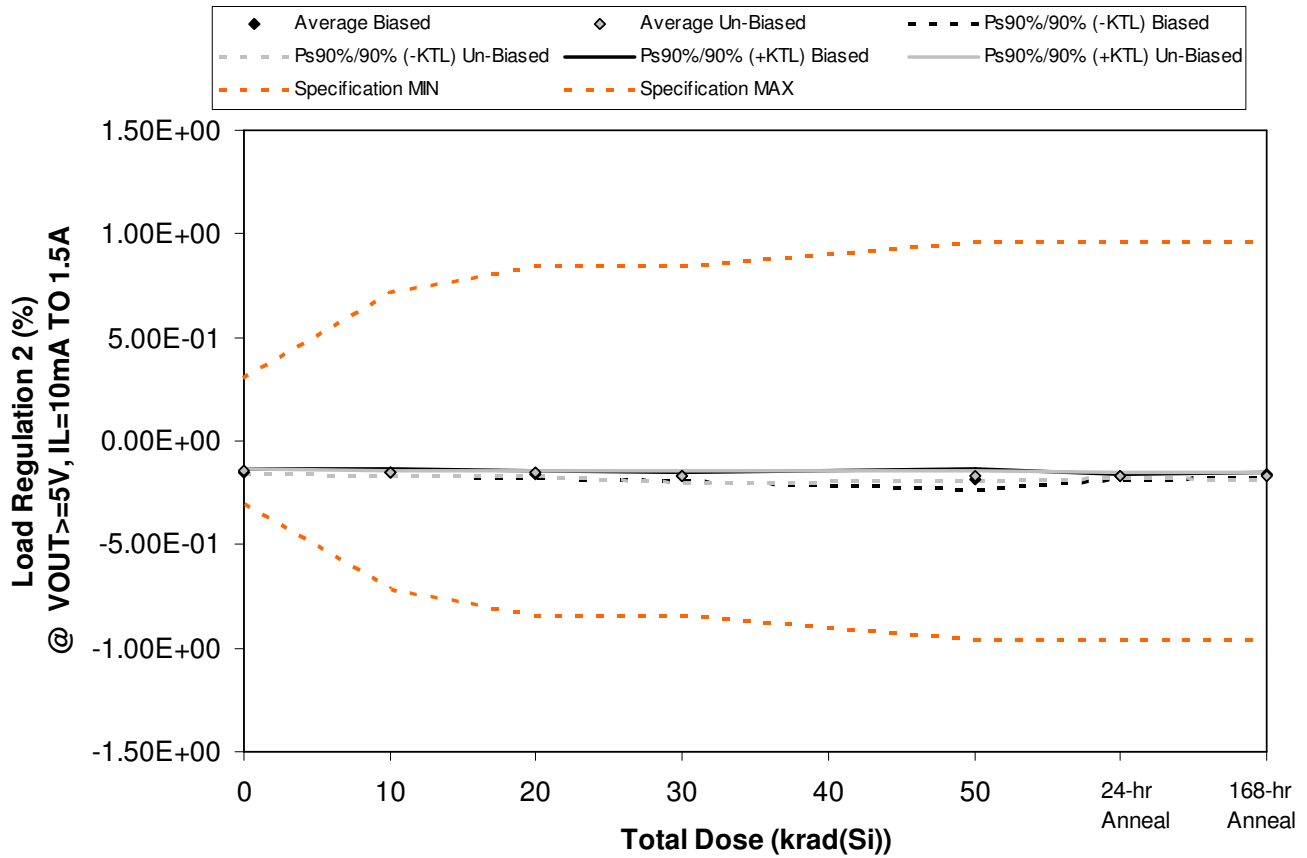

Figure 5.7. Plot of Load Regulation 2 (%) @  $V_{OUT} \geq 5V$ ,  $I_L = 10mA$  TO 1.5A versus total dose. The solid diamonds are the average of the measured data points for the samples irradiated under electrical bias while the shaded diamonds are the average of the measured data points for the samples irradiated with all pins tied to ground. The black lines (solid and/or dashed) are the average of the data points after application of the KTL statistics on the samples irradiated under electrical bias while the gray lines (solid and/or dashed) are the average of the data points after application of the KTL statistics on the samples irradiated in the unbiased condition. The red dotted line(s) are the pre- and/or post-irradiation minimum and/or maximum specification value as defined in the datasheet and/or test plan.



**ELDRS Report  
12-979 130327 R1.0**

**Aeroflex RAD  
5017 N. 30th Street  
Colorado Springs, CO 80919  
(719) 531-0800**

Table 5.7. Raw data for Load Regulation 2 (%) @ VOUT>=5V, IL=10mA TO 1.5A versus total dose, including the statistical analysis, specification and the status of the testing (pass/fail).

Load Regulation 2 (%) @ VOUT>=5V, IL=10mA TO 1.5A	Total Dose (krad(Si))					24-hr Anneal	168-hr Anneal
	0	10	20	30	50		
Device							
2	-1.53E-01	-1.49E-01	-1.64E-01	-1.64E-01	-1.75E-01	-1.62E-01	-1.68E-01
6	-1.49E-01	-1.57E-01	-1.67E-01	-1.63E-01	-2.18E-01	-1.75E-01	-1.72E-01
7	-1.41E-01	-1.48E-01	-1.50E-01	-1.75E-01	-1.82E-01	-1.72E-01	-1.63E-01
8	-1.42E-01	-1.46E-01	-1.65E-01	-1.72E-01	-1.82E-01	-1.69E-01	-1.56E-01
10	-1.53E-01	-1.58E-01	-1.54E-01	-1.79E-01	-1.71E-01	-1.73E-01	-1.62E-01
11	-1.52E-01	-1.47E-01	-1.52E-01	-1.71E-01	-1.54E-01	-1.62E-01	-1.61E-01
14	-1.48E-01	-1.58E-01	-1.53E-01	-1.79E-01	-1.71E-01	-1.60E-01	-1.62E-01
17	-1.47E-01	-1.54E-01	-1.62E-01	-1.64E-01	-1.82E-01	-1.68E-01	-1.68E-01
19	-1.43E-01	-1.56E-01	-1.56E-01	-1.54E-01	-1.72E-01	-1.69E-01	-1.78E-01
20	-1.45E-01	-1.52E-01	-1.48E-01	-1.79E-01	-1.69E-01	-1.65E-01	-1.69E-01
51	-1.66E-01	-1.63E-01	-1.52E-01	-1.42E-01	-1.63E-01	-1.69E-01	-1.54E-01
<b>Biased Statistics</b>							
Average Biased	-1.48E-01	-1.52E-01	-1.60E-01	-1.71E-01	-1.86E-01	-1.70E-01	-1.64E-01
Std Dev Biased	5.81E-03	5.50E-03	7.52E-03	6.95E-03	1.87E-02	5.07E-03	6.10E-03
Ps90%/90% (+KTL) Biased	-1.32E-01	-1.37E-01	-1.39E-01	-1.52E-01	-1.34E-01	-1.56E-01	-1.47E-01
Ps90%/90% (-KTL) Biased	-1.64E-01	-1.67E-01	-1.81E-01	-1.90E-01	-2.37E-01	-1.84E-01	-1.81E-01
<b>Un-Biased Statistics</b>							
Average Un-Biased	-1.47E-01	-1.53E-01	-1.54E-01	-1.69E-01	-1.70E-01	-1.65E-01	-1.68E-01
Std Dev Un-Biased	3.39E-03	4.22E-03	5.22E-03	1.06E-02	1.01E-02	3.83E-03	6.80E-03
Ps90%/90% (+KTL) Un-Biased	-1.38E-01	-1.42E-01	-1.40E-01	-1.40E-01	-1.42E-01	-1.54E-01	-1.49E-01
Ps90%/90% (-KTL) Un-Biased	-1.56E-01	-1.65E-01	-1.69E-01	-1.99E-01	-1.97E-01	-1.75E-01	-1.86E-01
<b>Specification MIN</b>	<b>-3.00E-01</b>	<b>-7.20E-01</b>	<b>-8.40E-01</b>	<b>-8.40E-01</b>	<b>-9.60E-01</b>	<b>-9.60E-01</b>	<b>-9.60E-01</b>
Status	PASS	PASS	PASS	PASS	PASS	PASS	PASS
<b>Specification MAX</b>	<b>3.00E-01</b>	<b>7.20E-01</b>	<b>8.40E-01</b>	<b>8.40E-01</b>	<b>9.60E-01</b>	<b>9.60E-01</b>	<b>9.60E-01</b>
Status	PASS	PASS	PASS	PASS	PASS	PASS	PASS

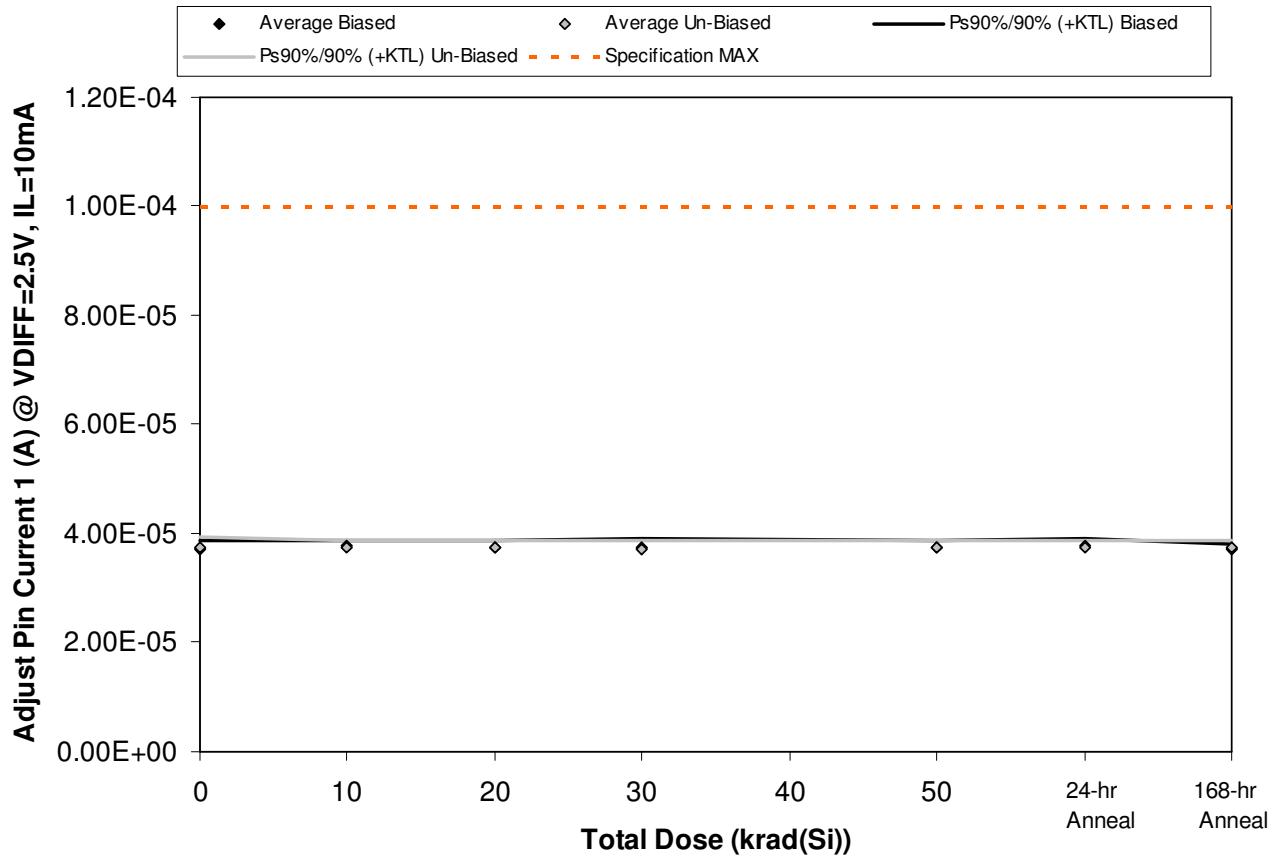

Figure 5.8. Plot of Adjust Pin Current 1 (A) @ VDIFF=2.5V, IL=10mA versus total dose. The solid diamonds are the average of the measured data points for the samples irradiated under electrical bias while the shaded diamonds are the average of the measured data points for the samples irradiated with all pins tied to ground. The black lines (solid and/or dashed) are the average of the data points after application of the KTL statistics on the samples irradiated under electrical bias while the gray lines (solid and/or dashed) are the average of the data points after application of the KTL statistics on the samples irradiated in the unbiased condition. The red dotted line(s) are the pre- and/or post-irradiation minimum and/or maximum specification value as defined in the datasheet and/or test plan.



**ELDRS Report  
12-979 130327 R1.0**

**Aeroflex RAD  
5017 N. 30th Street  
Colorado Springs, CO 80919  
(719) 531-0800**

Table 5.8. Raw data for Adjust Pin Current 1 (A) @ VDIFF=2.5V, IL=10mA versus total dose, including the statistical analysis, specification and the status of the testing (pass/fail).

Adjust Pin Current 1 (A) @ VDIFF=2.5V, IL=10mA	Total Dose (krad(Si))					24-hr Anneal	168-hr Anneal
	0	10	20	30	50		
Device							
2	3.68E-05	3.74E-05	3.69E-05	3.72E-05	3.72E-05	3.74E-05	3.68E-05
6	3.74E-05	3.80E-05	3.75E-05	3.74E-05	3.74E-05	3.79E-05	3.74E-05
7	3.80E-05	3.80E-05	3.81E-05	3.80E-05	3.79E-05	3.80E-05	3.75E-05
8	3.74E-05	3.80E-05	3.77E-05	3.80E-05	3.79E-05	3.80E-05	3.74E-05
10	3.68E-05	3.72E-05	3.69E-05	3.68E-05	3.68E-05	3.69E-05	3.68E-05
11	3.74E-05	3.74E-05	3.75E-05	3.74E-05	3.75E-05	3.75E-05	3.74E-05
14	3.74E-05	3.74E-05	3.75E-05	3.74E-05	3.74E-05	3.74E-05	3.74E-05
17	3.74E-05	3.72E-05	3.70E-05	3.68E-05	3.68E-05	3.69E-05	3.71E-05
19	3.85E-05	3.82E-05	3.81E-05	3.80E-05	3.80E-05	3.80E-05	3.80E-05
20	3.68E-05	3.68E-05	3.69E-05	3.68E-05	3.68E-05	3.68E-05	3.68E-05
51	3.68E-05	3.68E-05	3.69E-05	3.68E-05	3.68E-05	3.68E-05	3.68E-05
<b>Biased Statistics</b>							
Average Biased	3.73E-05	3.77E-05	3.74E-05	3.75E-05	3.74E-05	3.76E-05	3.72E-05
Std Dev Biased	5.10E-07	3.80E-07	5.23E-07	5.36E-07	4.78E-07	5.04E-07	3.64E-07
Ps90%/90% (+KTL) Biased	3.87E-05	3.88E-05	3.88E-05	3.89E-05	3.88E-05	3.90E-05	3.82E-05
Ps90%/90% (-KTL) Biased	3.59E-05	3.67E-05	3.59E-05	3.60E-05	3.61E-05	3.62E-05	3.62E-05
<b>Un-Biased Statistics</b>							
Average Un-Biased	3.75E-05	3.74E-05	3.74E-05	3.73E-05	3.73E-05	3.73E-05	3.73E-05
Std Dev Un-Biased	6.38E-07	5.06E-07	5.06E-07	5.11E-07	5.24E-07	5.03E-07	4.70E-07
Ps90%/90% (+KTL) Un-Biased	3.92E-05	3.88E-05	3.88E-05	3.87E-05	3.87E-05	3.87E-05	3.86E-05
Ps90%/90% (-KTL) Un-Biased	3.57E-05	3.60E-05	3.60E-05	3.59E-05	3.59E-05	3.59E-05	3.60E-05
<b>Specification MAX</b>	<b>1.00E-04</b>	<b>1.00E-04</b>	<b>1.00E-04</b>	<b>1.00E-04</b>	<b>1.00E-04</b>	<b>1.00E-04</b>	<b>1.00E-04</b>
Status	PASS	PASS	PASS	PASS	PASS	PASS	PASS

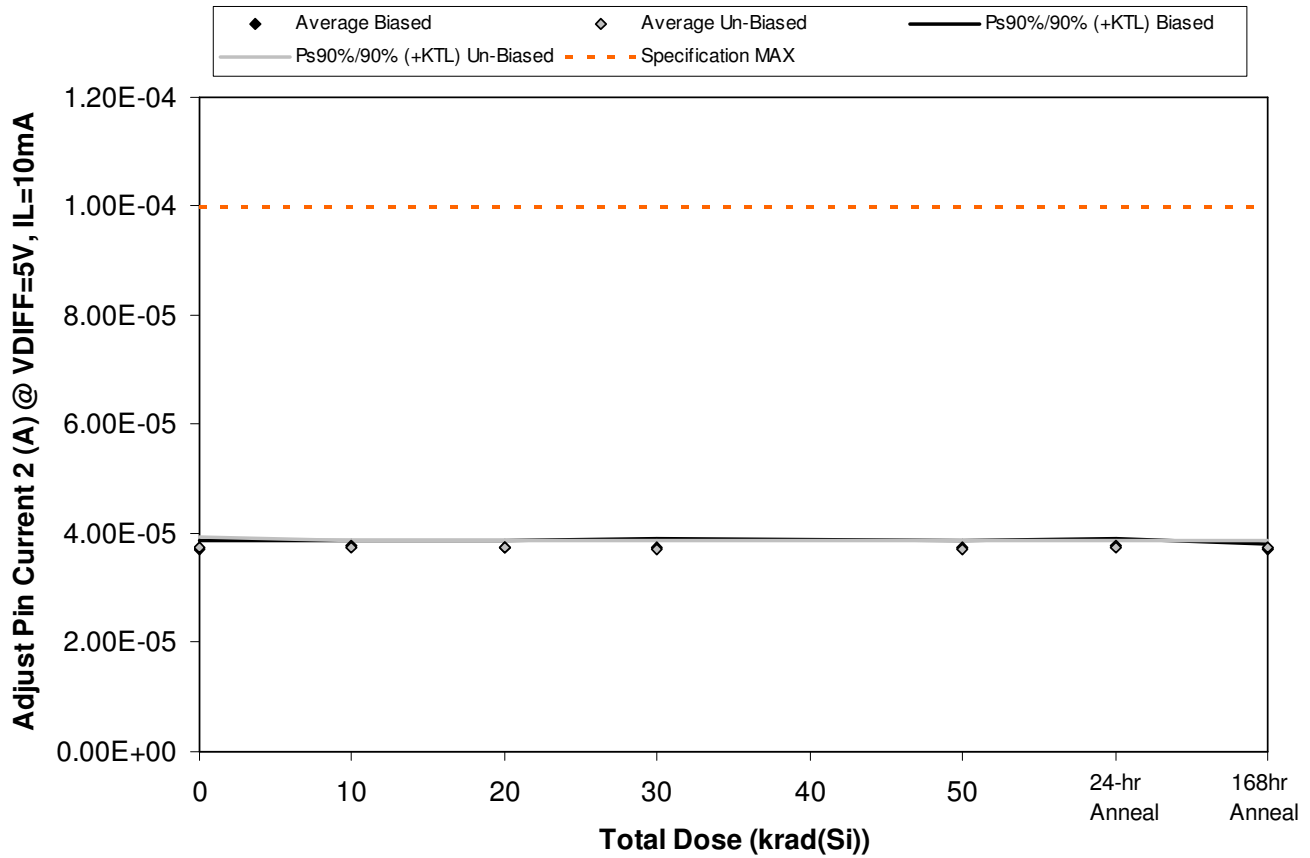

Figure 5.9. Plot of Adjust Pin Current 2 (A) @ VDIFF=5V, IL=10mA versus total dose. The solid diamonds are the average of the measured data points for the samples irradiated under electrical bias while the shaded diamonds are the average of the measured data points for the samples irradiated with all pins tied to ground. The black lines (solid and/or dashed) are the average of the data points after application of the KTL statistics on the samples irradiated under electrical bias while the gray lines (solid and/or dashed) are the average of the data points after application of the KTL statistics on the samples irradiated in the unbiased condition. The red dotted line(s) are the pre- and/or post-irradiation minimum and/or maximum specification value as defined in the datasheet and/or test plan.





**ELDRS Report  
12-979 130327 R1.0**

**Aeroflex RAD  
5017 N. 30th Street  
Colorado Springs, CO 80919  
(719) 531-0800**

Table 5.9. Raw data for Adjust Pin Current 2 (A) @ VDIFF=5V, IL=10mA versus total dose, including the statistical analysis, specification and the status of the testing (pass/fail).

Adjust Pin Current 2 (A) @ VDIFF=5V, IL=10mA	Total Dose (krad(Si))					24-hr Anneal	168-hr Anneal
	0	10	20	30	50		
Device							
2	3.68E-05	3.74E-05	3.69E-05	3.71E-05	3.71E-05	3.74E-05	3.68E-05
6	3.74E-05	3.79E-05	3.75E-05	3.75E-05	3.74E-05	3.79E-05	3.74E-05
7	3.80E-05	3.80E-05	3.81E-05	3.80E-05	3.79E-05	3.80E-05	3.75E-05
8	3.74E-05	3.80E-05	3.75E-05	3.80E-05	3.78E-05	3.80E-05	3.74E-05
10	3.68E-05	3.72E-05	3.69E-05	3.68E-05	3.68E-05	3.69E-05	3.68E-05
11	3.74E-05	3.74E-05	3.75E-05	3.74E-05	3.75E-05	3.74E-05	3.74E-05
14	3.74E-05	3.74E-05	3.75E-05	3.74E-05	3.74E-05	3.74E-05	3.74E-05
17	3.73E-05	3.71E-05	3.70E-05	3.68E-05	3.68E-05	3.69E-05	3.70E-05
19	3.86E-05	3.81E-05	3.81E-05	3.80E-05	3.80E-05	3.80E-05	3.81E-05
20	3.68E-05	3.68E-05	3.69E-05	3.68E-05	3.67E-05	3.68E-05	3.68E-05
51	3.68E-05	3.68E-05	3.69E-05	3.68E-05	3.69E-05	3.68E-05	3.68E-05
<b>Biased Statistics</b>							
Average Biased	3.73E-05	3.77E-05	3.74E-05	3.75E-05	3.74E-05	3.76E-05	3.72E-05
Std Dev Biased	5.10E-07	3.87E-07	5.07E-07	5.39E-07	4.78E-07	5.02E-07	3.64E-07
Ps90%/90% (+KTL) Biased	3.87E-05	3.88E-05	3.88E-05	3.90E-05	3.87E-05	3.90E-05	3.82E-05
Ps90%/90% (-KTL) Biased	3.59E-05	3.66E-05	3.60E-05	3.60E-05	3.61E-05	3.63E-05	3.62E-05
<b>Un-Biased Statistics</b>							
Average Un-Biased	3.75E-05	3.74E-05	3.74E-05	3.73E-05	3.73E-05	3.73E-05	3.73E-05
Std Dev Un-Biased	6.43E-07	4.96E-07	4.91E-07	5.11E-07	5.26E-07	4.92E-07	4.82E-07
Ps90%/90% (+KTL) Un-Biased	3.93E-05	3.87E-05	3.87E-05	3.87E-05	3.87E-05	3.87E-05	3.87E-05
Ps90%/90% (-KTL) Un-Biased	3.57E-05	3.60E-05	3.60E-05	3.59E-05	3.58E-05	3.60E-05	3.60E-05
<b>Specification MAX</b>	<b>1.00E-04</b>	<b>1.00E-04</b>	<b>1.00E-04</b>	<b>1.00E-04</b>	<b>1.00E-04</b>	<b>1.00E-04</b>	<b>1.00E-04</b>
Status	PASS	PASS	PASS	PASS	PASS	PASS	PASS

**An ISO 9001:2008 and DSCC Certified Company**

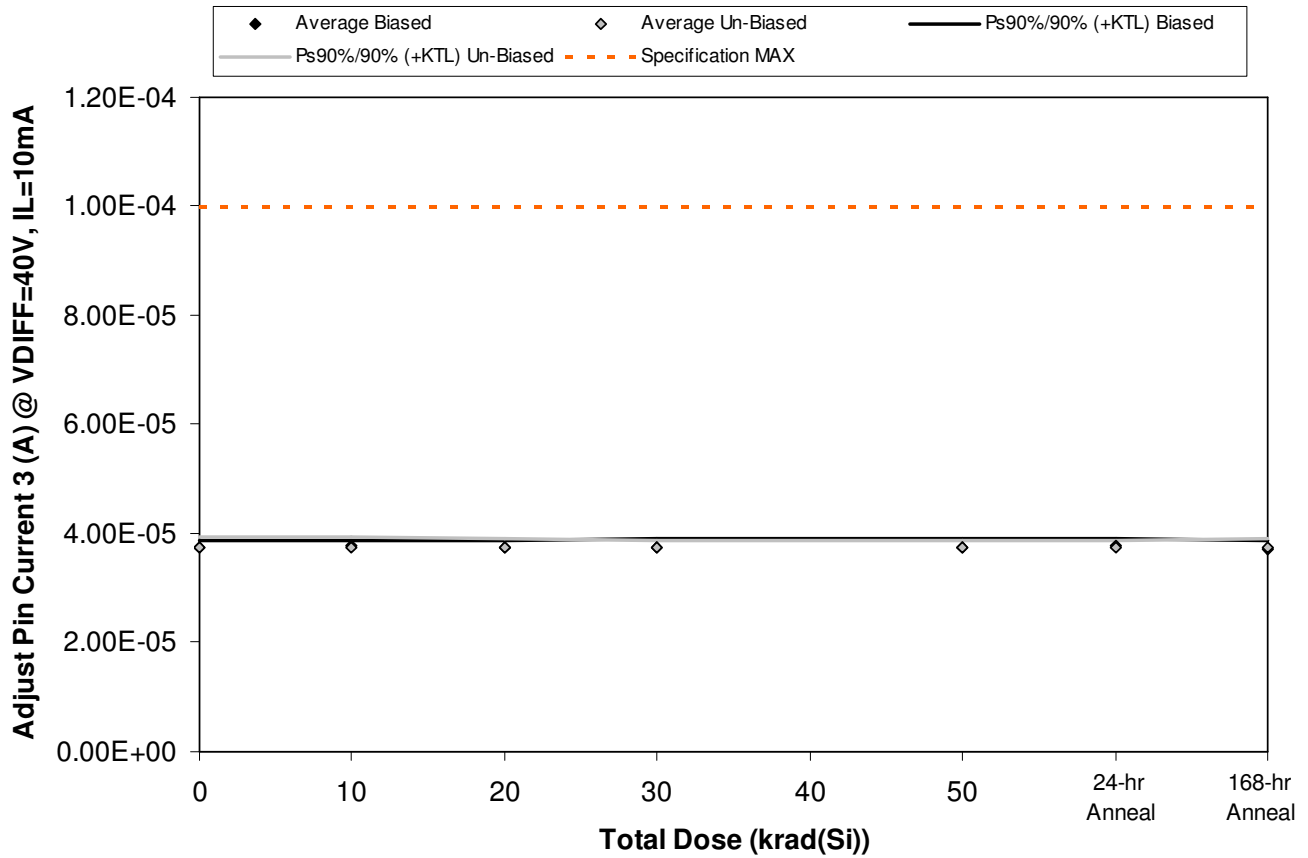

Figure 5.10. Plot of Adjust Pin Current 3 (A) @ VDIFF=40V, IL=10mA versus total dose. The solid diamonds are the average of the measured data points for the samples irradiated under electrical bias while the shaded diamonds are the average of the measured data points for the samples irradiated with all pins tied to ground. The black lines (solid and/or dashed) are the average of the data points after application of the KTL statistics on the samples irradiated under electrical bias while the gray lines (solid and/or dashed) are the average of the data points after application of the KTL statistics on the samples irradiated in the unbiased condition. The red dotted line(s) are the pre- and/or post-irradiation minimum and/or maximum specification value as defined in the datasheet and/or test plan.



**ELDRS Report  
12-979 130327 R1.0**

**Aeroflex RAD  
5017 N. 30th Street  
Colorado Springs, CO 80919  
(719) 531-0800**

Table 5.10. Raw data for Adjust Pin Current 3 (A) @ VDIFF=40V, IL=10mA versus total dose, including the statistical analysis, specification and the status of the testing (pass/fail).

Adjust Pin Current 3 (A) @ VDIFF=40V, IL=10mA	Total Dose (krad(Si))					24-hr Anneal	168-hr Anneal
	Device	0	10	20	30		
2	3.68E-05	3.74E-05	3.71E-05	3.73E-05	3.74E-05	3.74E-05	3.68E-05
6	3.74E-05	3.80E-05	3.75E-05	3.77E-05	3.74E-05	3.80E-05	3.74E-05
7	3.80E-05	3.80E-05	3.81E-05	3.80E-05	3.80E-05	3.80E-05	3.79E-05
8	3.74E-05	3.80E-05	3.79E-05	3.80E-05	3.80E-05	3.80E-05	3.74E-05
10	3.68E-05	3.73E-05	3.69E-05	3.68E-05	3.68E-05	3.70E-05	3.68E-05
11	3.76E-05	3.76E-05	3.75E-05	3.74E-05	3.76E-05	3.76E-05	3.74E-05
14	3.74E-05	3.74E-05	3.75E-05	3.74E-05	3.74E-05	3.74E-05	3.74E-05
17	3.74E-05	3.73E-05	3.73E-05	3.71E-05	3.69E-05	3.72E-05	3.73E-05
19	3.86E-05	3.85E-05	3.83E-05	3.80E-05	3.80E-05	3.81E-05	3.83E-05
20	3.68E-05	3.68E-05	3.69E-05	3.68E-05	3.68E-05	3.68E-05	3.68E-05
51	3.68E-05	3.69E-05	3.69E-05	3.68E-05	3.70E-05	3.70E-05	3.70E-05
<b>Biased Statistics</b>							
Average Biased	3.73E-05	3.78E-05	3.75E-05	3.76E-05	3.75E-05	3.77E-05	3.73E-05
Std Dev Biased	5.12E-07	3.52E-07	5.10E-07	5.19E-07	5.11E-07	4.55E-07	4.82E-07
Ps90%/90% (+KTL) Biased	3.87E-05	3.87E-05	3.89E-05	3.90E-05	3.89E-05	3.89E-05	3.86E-05
Ps90%/90% (-KTL) Biased	3.59E-05	3.68E-05	3.61E-05	3.61E-05	3.61E-05	3.64E-05	3.59E-05
<b>Un-Biased Statistics</b>							
Average Un-Biased	3.76E-05	3.75E-05	3.75E-05	3.73E-05	3.73E-05	3.74E-05	3.74E-05
Std Dev Un-Biased	6.65E-07	6.21E-07	5.40E-07	4.56E-07	5.22E-07	4.66E-07	5.34E-07
Ps90%/90% (+KTL) Un-Biased	3.94E-05	3.92E-05	3.90E-05	3.86E-05	3.88E-05	3.87E-05	3.89E-05
Ps90%/90% (-KTL) Un-Biased	3.57E-05	3.58E-05	3.60E-05	3.61E-05	3.59E-05	3.61E-05	3.60E-05
<b>Specification MAX</b>	<b>1.00E-04</b>	<b>1.00E-04</b>	<b>1.00E-04</b>	<b>1.00E-04</b>	<b>1.00E-04</b>	<b>1.00E-04</b>	<b>1.00E-04</b>
Status	PASS	PASS	PASS	PASS	PASS	PASS	PASS

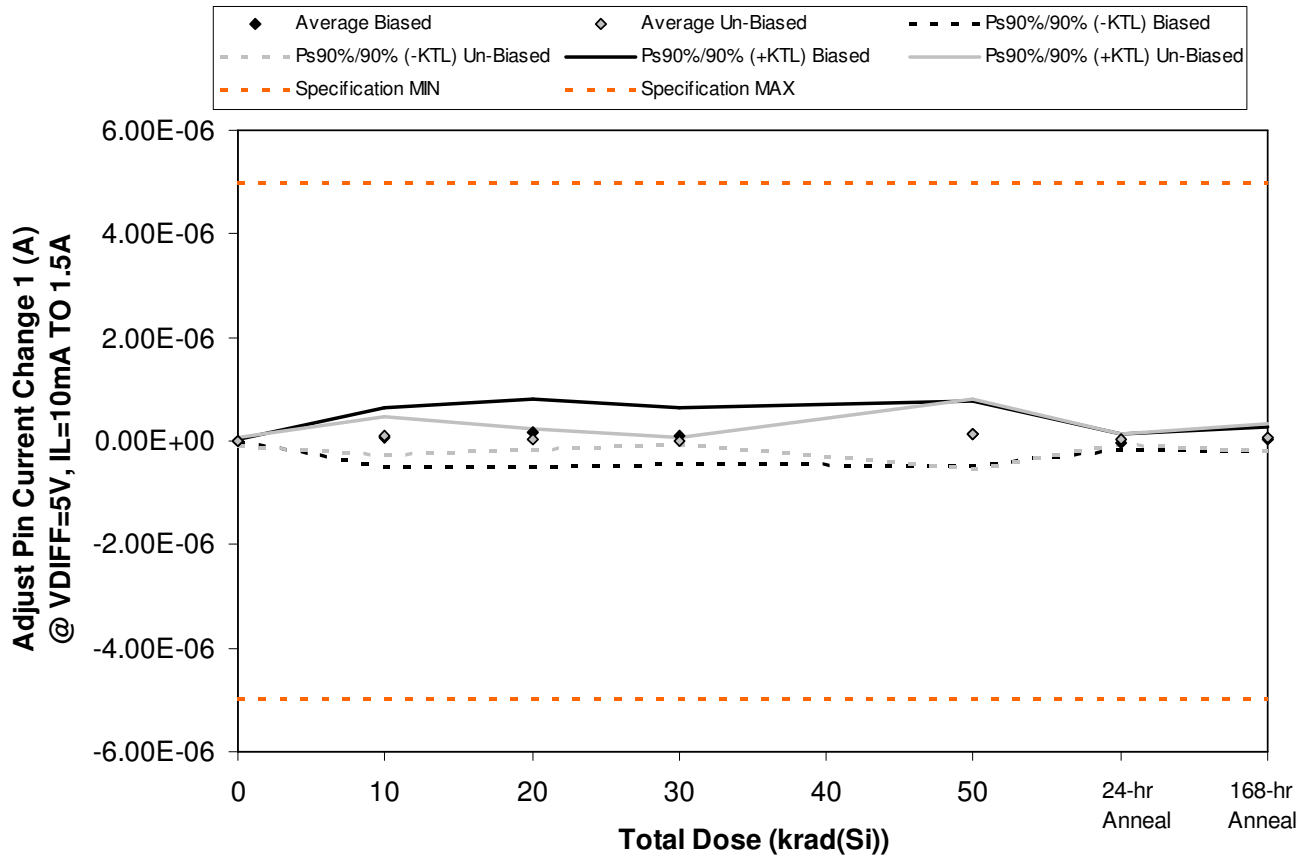

Figure 5.11. Plot of Adjust Pin Current Change 1 (A) @ VDIFF=5V, IL=10mA TO 1.5A versus total dose. The solid diamonds are the average of the measured data points for the samples irradiated under electrical bias while the shaded diamonds are the average of the measured data points for the samples irradiated with all pins tied to ground. The black lines (solid and/or dashed) are the average of the data points after application of the KTL statistics on the samples irradiated under electrical bias while the gray lines (solid and/or dashed) are the average of the data points after application of the KTL statistics on the samples irradiated in the unbiased condition. The red dotted line(s) are the pre- and/or post-irradiation minimum and/or maximum specification value as defined in the datasheet and/or test plan.



**ELDRS Report  
12-979 130327 R1.0**

**Aeroflex RAD  
5017 N. 30th Street  
Colorado Springs, CO 80919  
(719) 531-0800**

Table 5.11. Raw data for Adjust Pin Current Change 1 (A) @ VDIFF=5V, IL=10mA TO 1.5A versus total dose, including the statistical analysis, specification and the status of the testing (pass/fail).

Adjust Pin Current Change 1 (A) @ VDIFF=5V, IL=10mA TO 1.5A	Total Dose (krad(Si))					24-hr Anneal	168-hr Anneal
	0	10	20	30	50		
Device							
2	0.00E+00	0.00E+00	4.90E-08	4.40E-07	3.67E-07	0.00E+00	0.00E+00
6	0.00E+00	-8.60E-08	0.00E+00	3.70E-08	0.00E+00	-1.22E-07	0.00E+00
7	0.00E+00	0.00E+00	5.74E-07	0.00E+00	-6.10E-08	0.00E+00	1.83E-07
8	1.20E-08	0.00E+00	1.47E-07	0.00E+00	4.28E-07	0.00E+00	0.00E+00
10	0.00E+00	4.40E-07	0.00E+00	0.00E+00	0.00E+00	3.70E-08	0.00E+00
11	2.40E-08	2.40E-08	0.00E+00	0.00E+00	7.30E-08	6.10E-08	0.00E+00
14	0.00E+00	0.00E+00	0.00E+00	-1.20E-08	0.00E+00	0.00E+00	0.00E+00
17	-4.90E-08	3.06E-07	1.71E-07	4.90E-08	2.40E-08	6.10E-08	2.32E-07
19	-4.90E-08	1.47E-07	3.70E-08	0.00E+00	0.00E+00	0.00E+00	7.30E-08
20	0.00E+00	0.00E+00	0.00E+00	-2.40E-08	5.74E-07	-1.20E-08	0.00E+00
51	0.00E+00	0.00E+00	0.00E+00	0.00E+00	6.10E-08	4.90E-08	3.70E-08
<b>Biased Statistics</b>							
Average Biased	2.40E-09	7.08E-08	1.54E-07	9.54E-08	1.47E-07	-1.70E-08	3.66E-08
Std Dev Biased	5.37E-09	2.10E-07	2.42E-07	1.93E-07	2.31E-07	6.08E-08	8.18E-08
Ps90%/90% (+KTL) Biased	1.71E-08	6.46E-07	8.18E-07	6.25E-07	7.81E-07	1.50E-07	2.61E-07
Ps90%/90% (-KTL) Biased	-1.23E-08	-5.04E-07	-5.10E-07	-4.35E-07	-4.87E-07	-1.84E-07	-1.88E-07
<b>Un-Biased Statistics</b>							
Average Un-Biased	-1.48E-08	9.54E-08	4.16E-08	2.60E-09	1.34E-07	2.20E-08	6.10E-08
Std Dev Un-Biased	3.27E-08	1.33E-07	7.41E-08	2.78E-08	2.48E-07	3.59E-08	1.01E-07
Ps90%/90% (+KTL) Un-Biased	7.49E-08	4.59E-07	2.45E-07	7.88E-08	8.13E-07	1.21E-07	3.37E-07
Ps90%/90% (-KTL) Un-Biased	-1.05E-07	-2.68E-07	-1.62E-07	-7.36E-08	-5.45E-07	-7.65E-08	-2.15E-07
<b>Specification MIN</b>	<b>-5.00E-06</b>	<b>-5.00E-06</b>	<b>-5.00E-06</b>	<b>-5.00E-06</b>	<b>-5.00E-06</b>	<b>-5.00E-06</b>	<b>-5.00E-06</b>
Status	PASS	PASS	PASS	PASS	PASS	PASS	PASS
<b>Specification MAX</b>	<b>5.00E-06</b>	<b>5.00E-06</b>	<b>5.00E-06</b>	<b>5.00E-06</b>	<b>5.00E-06</b>	<b>5.00E-06</b>	<b>5.00E-06</b>
Status	PASS	PASS	PASS	PASS	PASS	PASS	PASS

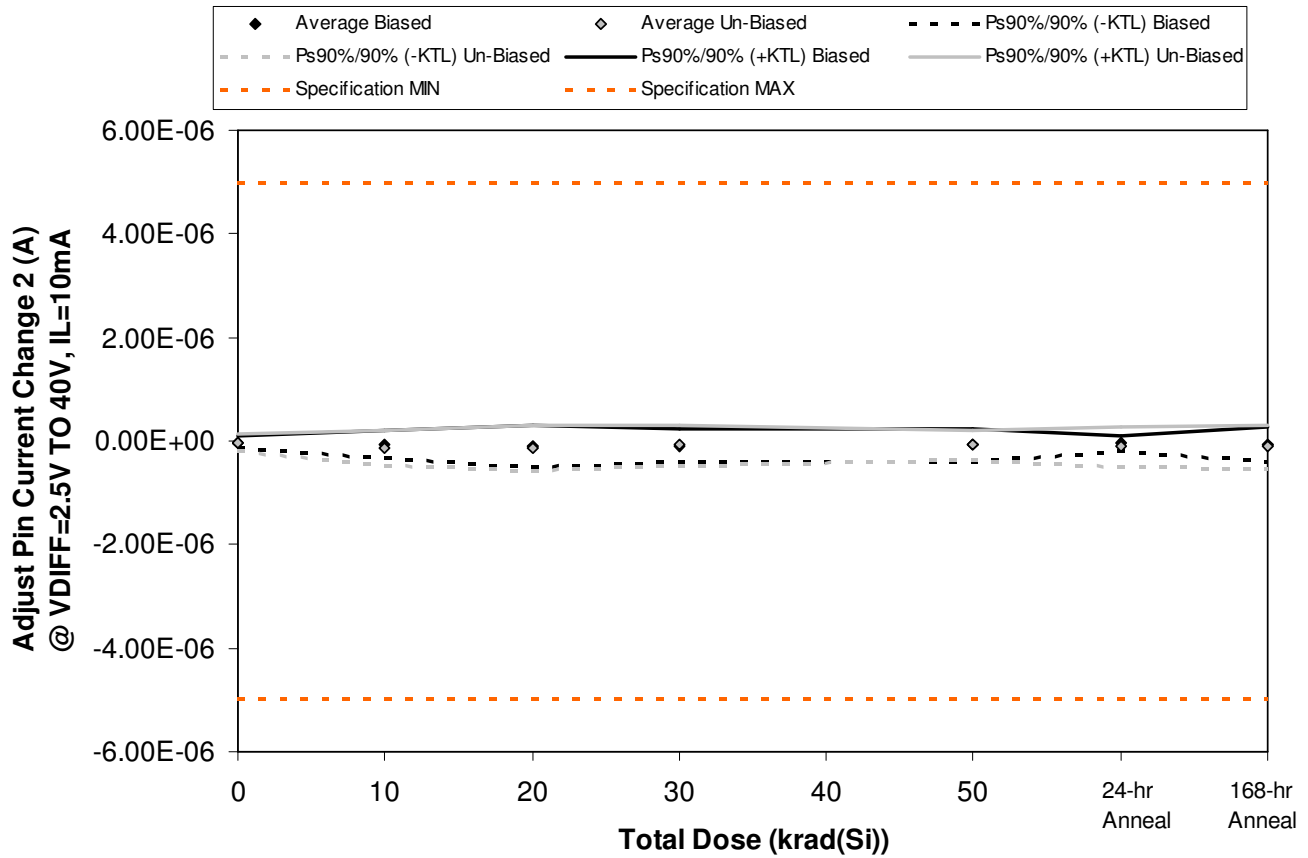

Figure 5.12. Plot of Adjust Pin Current Change 2 (A) @ VDIFF=2.5V TO 40V, IL=10mA versus total dose. The solid diamonds are the average of the measured data points for the samples irradiated under electrical bias while the shaded diamonds are the average of the measured data points for the samples irradiated with all pins tied to ground. The black lines (solid and/or dashed) are the average of the data points after application of the KTL statistics on the samples irradiated under electrical bias while the gray lines (solid and/or dashed) are the average of the data points after application of the KTL statistics on the samples irradiated in the unbiased condition. The red dotted line(s) are the pre- and/or post-irradiation minimum and/or maximum specification value as defined in the datasheet and/or test plan.



**ELDRS Report  
12-979 130327 R1.0**

**Aeroflex RAD  
5017 N. 30th Street  
Colorado Springs, CO 80919  
(719) 531-0800**

Table 5.12. Raw data for Adjust Pin Current Change 2 (A) @ VDIFF=2.5V TO 40V, IL=10mA versus total dose, including the statistical analysis, specification and the status of the testing (pass/fail).

Adjust Pin Current Change 2 (A) @ VDIFF=2.5V TO 40V, IL=10mA	Total Dose (krad(Si))					24-hr Anneal	168-hr Anneal
	0	10	20	30	50		
Device							
2	0.00E+00	0.00E+00	-1.59E-07	-2.69E-07	-2.81E-07	-1.20E-08	0.00E+00
6	0.00E+00	-1.10E-07	0.00E+00	-1.34E-07	0.00E+00	-1.22E-07	0.00E+00
7	-1.20E-08	-2.40E-08	-2.40E-08	0.00E+00	-6.10E-08	0.00E+00	-2.81E-07
8	-9.80E-08	0.00E+00	-3.42E-07	0.00E+00	-6.10E-08	0.00E+00	-2.40E-08
10	0.00E+00	-2.32E-07	0.00E+00	-2.40E-08	0.00E+00	-8.60E-08	0.00E+00
11	-1.47E-07	-2.08E-07	-2.40E-08	0.00E+00	-2.69E-07	-2.32E-07	-1.20E-08
14	0.00E+00	0.00E+00	-1.20E-08	-4.90E-08	-2.40E-08	0.00E+00	0.00E+00
17	-1.20E-08	-2.08E-07	-3.67E-07	-3.30E-07	-6.10E-08	-2.93E-07	-1.96E-07
19	-4.90E-08	-2.69E-07	-1.96E-07	-2.40E-08	0.00E+00	-2.40E-08	-3.42E-07
20	0.00E+00	0.00E+00	0.00E+00	-1.20E-08	-6.10E-08	-2.40E-08	0.00E+00
51	0.00E+00	-2.40E-08	-2.40E-08	-1.20E-08	-3.06E-07	-1.71E-07	-1.59E-07
<b>Biased Statistics</b>							
Average Biased	-2.20E-08	-7.32E-08	-1.05E-07	-8.54E-08	-8.06E-08	-4.40E-08	-6.10E-08
Std Dev Biased	4.28E-08	9.96E-08	1.48E-07	1.17E-07	1.16E-07	5.64E-08	1.23E-07
Ps90%/90% (+KTL) Biased	9.54E-08	2.00E-07	3.01E-07	2.34E-07	2.38E-07	1.11E-07	2.77E-07
Ps90%/90% (-KTL) Biased	-1.39E-07	-3.46E-07	-5.11E-07	-4.05E-07	-3.99E-07	-1.99E-07	-3.99E-07
<b>Un-Biased Statistics</b>							
Average Un-Biased	-4.16E-08	-1.37E-07	-1.20E-07	-8.30E-08	-8.30E-08	-1.15E-07	-1.10E-07
Std Dev Un-Biased	6.23E-08	1.28E-07	1.60E-07	1.39E-07	1.07E-07	1.37E-07	1.54E-07
Ps90%/90% (+KTL) Un-Biased	1.29E-07	2.13E-07	3.18E-07	2.99E-07	2.11E-07	2.61E-07	3.13E-07
Ps90%/90% (-KTL) Un-Biased	-2.12E-07	-4.87E-07	-5.58E-07	-4.65E-07	-3.77E-07	-4.90E-07	-5.33E-07
<b>Specification MIN</b>	<b>-5.00E-06</b>	<b>-5.00E-06</b>	<b>-5.00E-06</b>	<b>-5.00E-06</b>	<b>-5.00E-06</b>	<b>-5.00E-06</b>	<b>-5.00E-06</b>
Status	PASS	PASS	PASS	PASS	PASS	PASS	PASS
<b>Specification MAX</b>	<b>5.00E-06</b>	<b>5.00E-06</b>	<b>5.00E-06</b>	<b>5.00E-06</b>	<b>5.00E-06</b>	<b>5.00E-06</b>	<b>5.00E-06</b>
Status	PASS	PASS	PASS	PASS	PASS	PASS	PASS

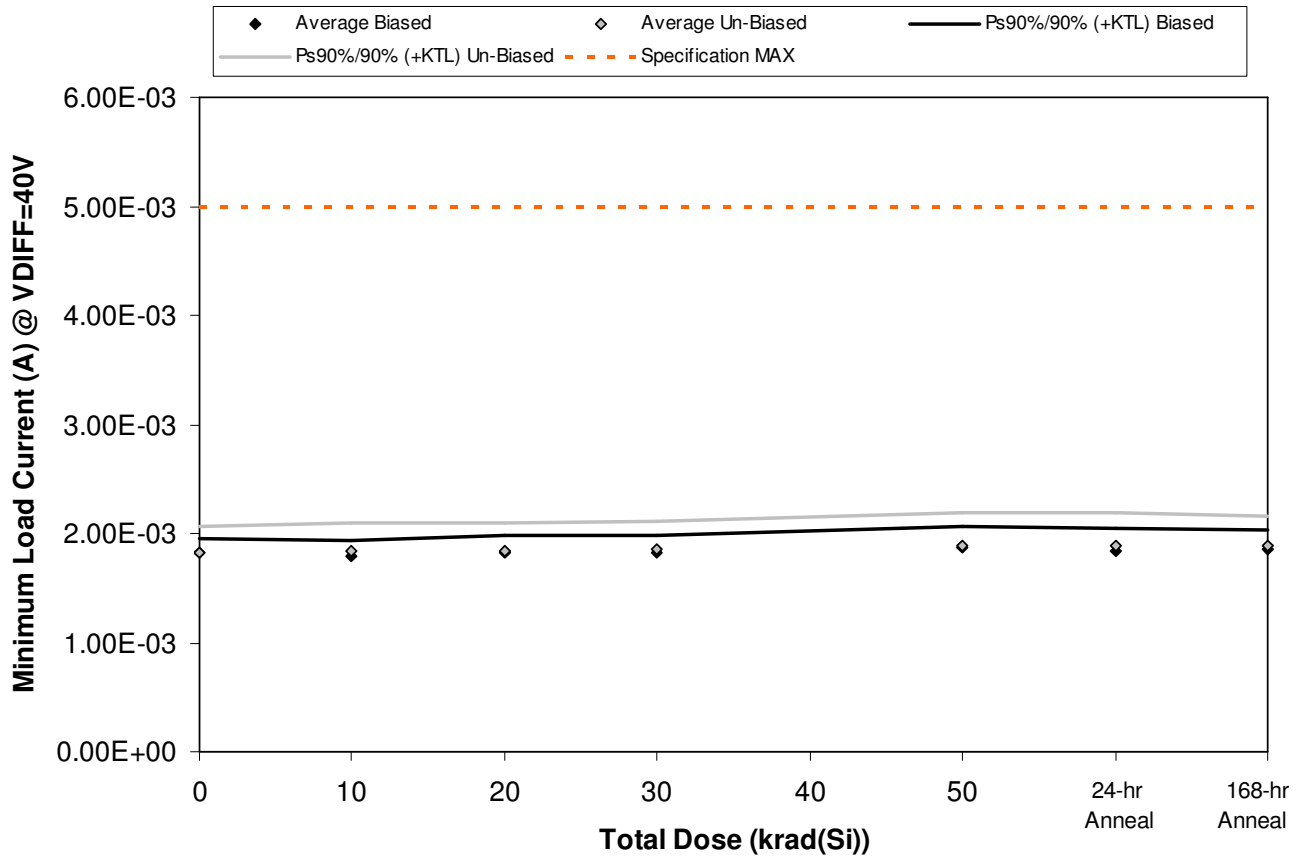

Figure 5.13. Plot of Minimum Load Current (A) @ VDIFF=40V versus total dose. The solid diamonds are the average of the measured data points for the samples irradiated under electrical bias while the shaded diamonds are the average of the measured data points for the samples irradiated with all pins tied to ground. The black lines (solid and/or dashed) are the average of the data points after application of the KTL statistics on the samples irradiated under electrical bias while the gray lines (solid and/or dashed) are the average of the data points after application of the KTL statistics on the samples irradiated in the unbiased condition. The red dotted line(s) are the pre- and/or post-irradiation minimum and/or maximum specification value as defined in the datasheet and/or test plan.





**ELDRS Report  
12-979 130327 R1.0**

**Aeroflex RAD  
5017 N. 30th Street  
Colorado Springs, CO 80919  
(719) 531-0800**

Table 5.13. Raw data for Minimum Load Current (A) @ VDIFF=40V versus total dose, including the statistical analysis, specification and the status of the testing (pass/fail).

Minimum Load Current (A) @ VDIFF=40V	Total Dose (krad(Si))					24-hr Anneal	168-hr Anneal
	0	10	20	30	50		
Device							
2	1.77E-03	1.73E-03	1.75E-03	1.75E-03	1.77E-03	1.75E-03	1.79E-03
6	1.84E-03	1.81E-03	1.84E-03	1.84E-03	1.90E-03	1.88E-03	1.90E-03
7	1.88E-03	1.86E-03	1.90E-03	1.90E-03	1.96E-03	1.94E-03	1.94E-03
8	1.83E-03	1.79E-03	1.83E-03	1.81E-03	1.85E-03	1.83E-03	1.86E-03
10	1.77E-03	1.75E-03	1.79E-03	1.79E-03	1.85E-03	1.83E-03	1.83E-03
11	1.81E-03	1.81E-03	1.83E-03	1.83E-03	1.83E-03	1.83E-03	1.83E-03
14	1.79E-03	1.79E-03	1.79E-03	1.81E-03	1.83E-03	1.83E-03	1.83E-03
17	1.77E-03	1.79E-03	1.79E-03	1.81E-03	1.83E-03	1.83E-03	1.83E-03
19	1.98E-03	2.00E-03	2.00E-03	2.02E-03	2.08E-03	2.08E-03	2.06E-03
20	1.81E-03	1.81E-03	1.83E-03	1.84E-03	1.87E-03	1.86E-03	1.86E-03
51	1.79E-03	1.79E-03	1.79E-03	1.79E-03	1.77E-03	1.79E-03	1.79E-03
<b>Biased Statistics</b>							
Average Biased	1.82E-03	1.79E-03	1.82E-03	1.82E-03	1.87E-03	1.85E-03	1.86E-03
Std Dev Biased	5.07E-05	5.23E-05	5.82E-05	5.85E-05	7.32E-05	7.26E-05	6.21E-05
Ps90%/90% (+KTL) Biased	1.96E-03	1.93E-03	1.98E-03	1.98E-03	2.07E-03	2.04E-03	2.03E-03
Ps90%/90% (-KTL) Biased	1.68E-03	1.64E-03	1.66E-03	1.66E-03	1.66E-03	1.65E-03	1.69E-03
<b>Un-Biased Statistics</b>							
Average Un-Biased	1.83E-03	1.84E-03	1.85E-03	1.86E-03	1.88E-03	1.88E-03	1.88E-03
Std Dev Un-Biased	8.77E-05	9.37E-05	9.08E-05	9.02E-05	1.10E-04	1.11E-04	1.04E-04
Ps90%/90% (+KTL) Un-Biased	2.07E-03	2.09E-03	2.09E-03	2.11E-03	2.19E-03	2.19E-03	2.16E-03
Ps90%/90% (-KTL) Un-Biased	1.59E-03	1.58E-03	1.60E-03	1.61E-03	1.58E-03	1.58E-03	1.60E-03
<b>Specification MAX</b>	<b>5.00E-03</b>	<b>5.00E-03</b>	<b>5.00E-03</b>	<b>5.00E-03</b>	<b>5.00E-03</b>	<b>5.00E-03</b>	<b>5.00E-03</b>
Status	PASS	PASS	PASS	PASS	PASS	PASS	PASS

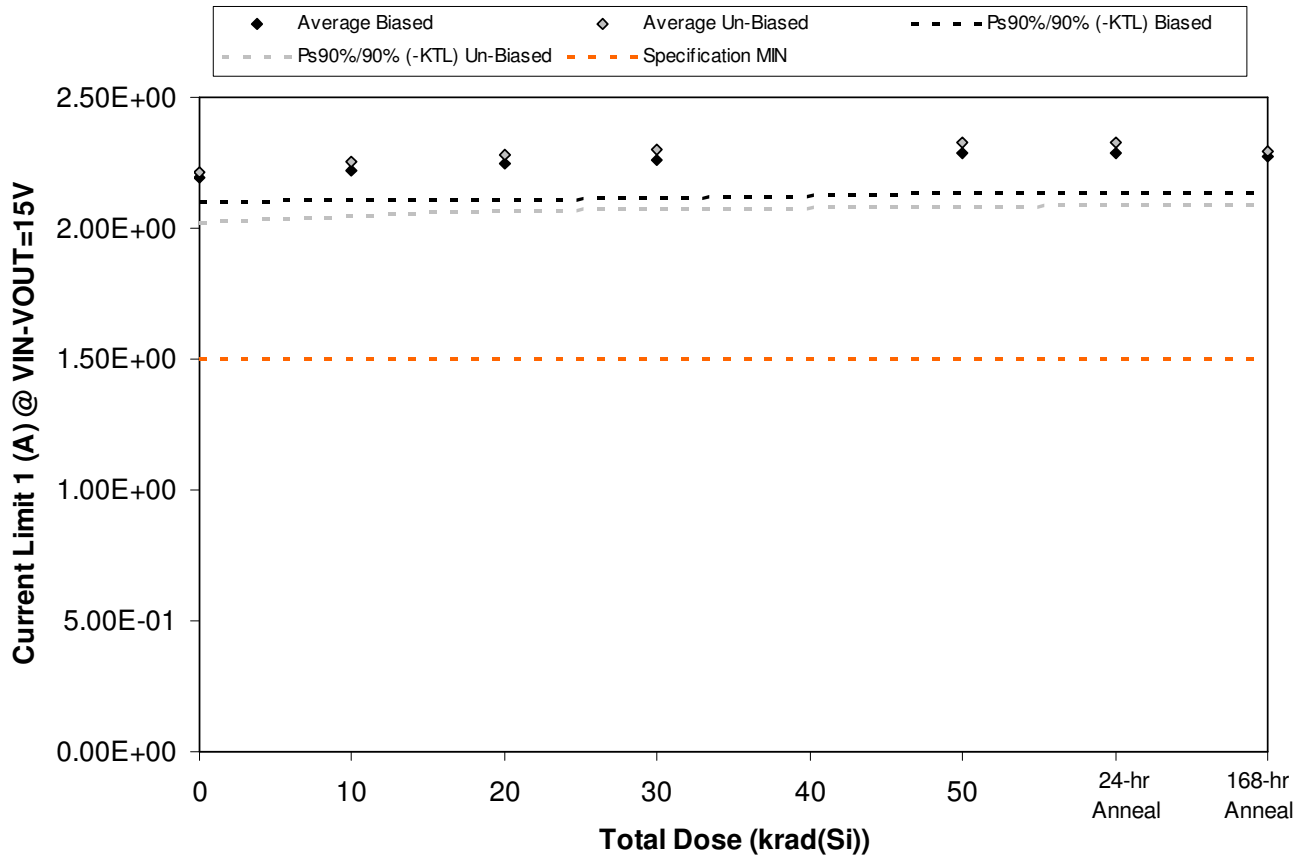

Figure 5.14. Plot of Current Limit 1 (A) @ VIN-VOUT=15V versus total dose. The solid diamonds are the average of the measured data points for the samples irradiated under electrical bias while the shaded diamonds are the average of the measured data points for the samples irradiated with all pins tied to ground. The black lines (solid and/or dashed) are the average of the data points after application of the KTL statistics on the samples irradiated under electrical bias while the gray lines (solid and/or dashed) are the average of the data points after application of the KTL statistics on the samples irradiated in the unbiased condition. The red dotted line(s) are the pre- and/or post-irradiation minimum and/or maximum specification value as defined in the datasheet and/or test plan.



**ELDRS Report  
12-979 130327 R1.0**

**Aeroflex RAD  
5017 N. 30th Street  
Colorado Springs, CO 80919  
(719) 531-0800**

Table 5.14. Raw data for Current Limit 1 (A) @ VIN-VOUT=15V versus total dose, including the statistical analysis, specification and the status of the testing (pass/fail).

Current Limit 1 (A) @ VIN-VOUT=15V	Total Dose (krad(Si))					24-hr Anneal	168-hr Anneal
	0	10	20	30	50		
Device							
2	2.19E+00	2.20E+00	2.22E+00	2.23E+00	2.25E+00	2.25E+00	2.24E+00
6	2.22E+00	2.25E+00	2.28E+00	2.30E+00	2.33E+00	2.33E+00	2.31E+00
7	2.20E+00	2.24E+00	2.26E+00	2.28E+00	2.32E+00	2.31E+00	2.29E+00
8	2.14E+00	2.16E+00	2.17E+00	2.19E+00	2.21E+00	2.21E+00	2.20E+00
10	2.23E+00	2.26E+00	2.29E+00	2.31E+00	2.34E+00	2.34E+00	2.32E+00
11	2.23E+00	2.25E+00	2.27E+00	2.29E+00	2.30E+00	2.30E+00	2.28E+00
14	2.18E+00	2.21E+00	2.23E+00	2.25E+00	2.28E+00	2.28E+00	2.25E+00
17	2.16E+00	2.20E+00	2.22E+00	2.25E+00	2.27E+00	2.28E+00	2.25E+00
19	2.34E+00	2.38E+00	2.41E+00	2.45E+00	2.49E+00	2.49E+00	2.43E+00
20	2.17E+00	2.22E+00	2.25E+00	2.27E+00	2.30E+00	2.30E+00	2.25E+00
51	2.19E+00	2.19E+00	2.19E+00	2.19E+00	2.19E+00	2.19E+00	2.19E+00
<b>Biased Statistics</b>							
Average Biased	2.20E+00	2.22E+00	2.24E+00	2.26E+00	2.29E+00	2.29E+00	2.27E+00
Std Dev Biased	3.45E-02	4.35E-02	4.93E-02	5.36E-02	5.78E-02	5.54E-02	5.01E-02
Ps90%/90% (+KTL) Biased	2.29E+00	2.34E+00	2.38E+00	2.41E+00	2.45E+00	2.44E+00	2.41E+00
Ps90%/90% (-KTL) Biased	2.10E+00	2.10E+00	2.11E+00	2.12E+00	2.13E+00	2.14E+00	2.14E+00
<b>Un-Biased Statistics</b>							
Average Un-Biased	2.22E+00	2.25E+00	2.28E+00	2.30E+00	2.33E+00	2.33E+00	2.29E+00
Std Dev Un-Biased	7.19E-02	7.43E-02	7.81E-02	8.23E-02	9.15E-02	8.79E-02	7.57E-02
Ps90%/90% (+KTL) Un-Biased	2.41E+00	2.46E+00	2.49E+00	2.53E+00	2.58E+00	2.57E+00	2.50E+00
Ps90%/90% (-KTL) Un-Biased	2.02E+00	2.05E+00	2.06E+00	2.08E+00	2.08E+00	2.09E+00	2.08E+00
<b>Specification MIN</b>	<b>1.50E+00</b>	<b>1.50E+00</b>	<b>1.50E+00</b>	<b>1.50E+00</b>	<b>1.50E+00</b>	<b>1.50E+00</b>	<b>1.50E+00</b>
Status	PASS	PASS	PASS	PASS	PASS	PASS	PASS

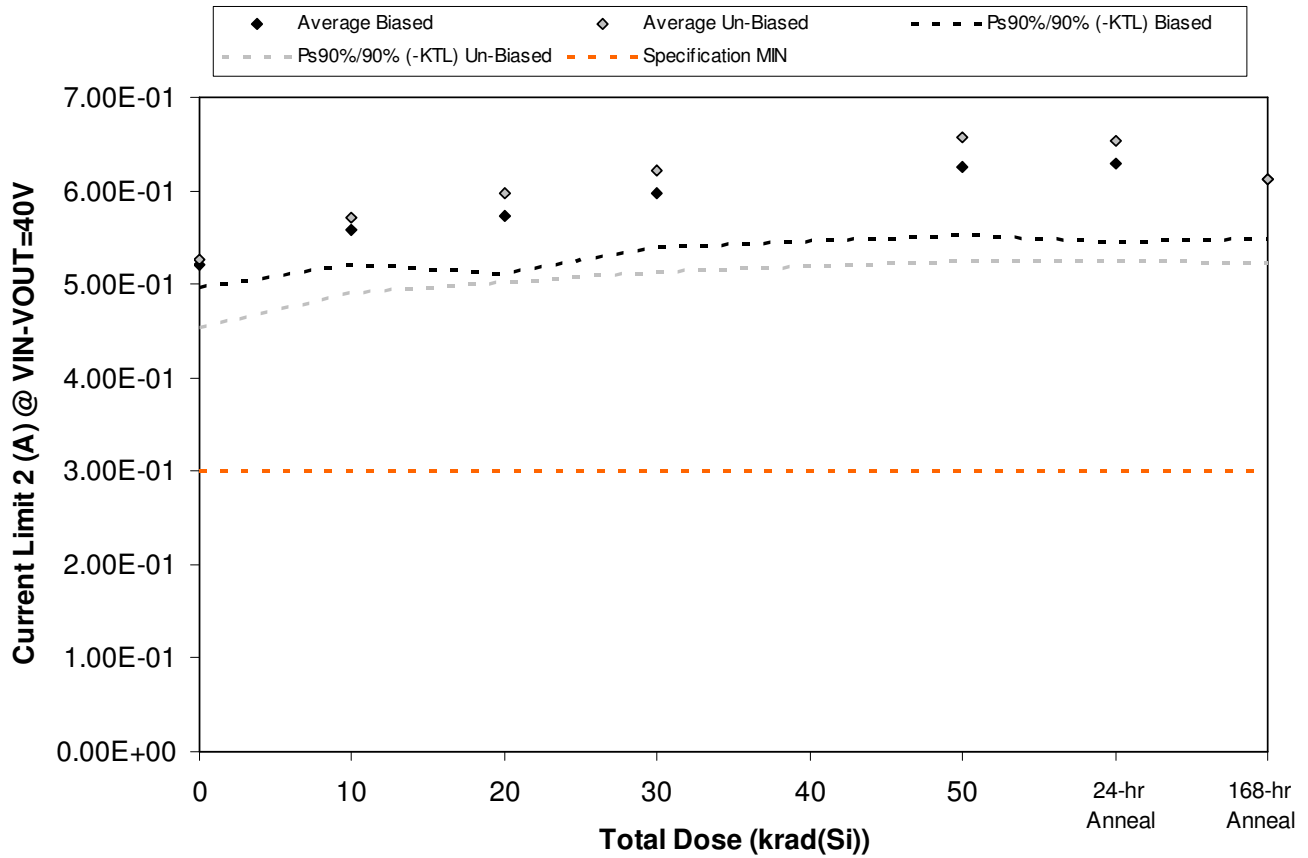

Figure 5.15. Plot of Current Limit 2 (A) @ VIN-VOUT=40V versus total dose. The solid diamonds are the average of the measured data points for the samples irradiated under electrical bias while the shaded diamonds are the average of the measured data points for the samples irradiated with all pins tied to ground. The black lines (solid and/or dashed) are the average of the data points after application of the KTL statistics on the samples irradiated under electrical bias while the gray lines (solid and/or dashed) are the average of the data points after application of the KTL statistics on the samples irradiated in the unbiased condition. The red dotted line(s) are the pre- and/or post-irradiation minimum and/or maximum specification value as defined in the datasheet and/or test plan.



**ELDRS Report  
12-979 130327 R1.0**

**Aeroflex RAD  
5017 N. 30th Street  
Colorado Springs, CO 80919  
(719) 531-0800**

Table 5.15. Raw data for Current Limit 2 (A) @ VIN-VOUT=40V versus total dose, including the statistical analysis, specification and the status of the testing (pass/fail).

Current Limit 2 (A) @ VIN-VOUT=40V	Total Dose (krad(Si))					24-hr Anneal	168-hr Anneal
	0	10	20	30	50		
Device							
2	5.35E-01	5.58E-01	5.69E-01	5.91E-01	6.13E-01	6.08E-01	6.03E-01
6	5.24E-01	5.69E-01	5.86E-01	6.08E-01	6.41E-01	6.52E-01	6.25E-01
7	5.13E-01	5.69E-01	5.91E-01	6.13E-01	6.46E-01	6.52E-01	6.25E-01
8	5.13E-01	5.35E-01	5.36E-01	5.63E-01	5.85E-01	5.86E-01	5.75E-01
10	5.19E-01	5.63E-01	5.86E-01	6.13E-01	6.46E-01	6.52E-01	6.30E-01
11	5.35E-01	5.63E-01	5.80E-01	5.91E-01	6.19E-01	6.13E-01	5.92E-01
14	5.13E-01	5.58E-01	5.80E-01	6.02E-01	6.35E-01	6.35E-01	5.97E-01
17	5.13E-01	5.52E-01	5.80E-01	6.13E-01	6.41E-01	6.41E-01	6.03E-01
19	5.69E-01	6.24E-01	6.58E-01	6.91E-01	7.41E-01	7.35E-01	6.69E-01
20	5.02E-01	5.63E-01	5.86E-01	6.13E-01	6.46E-01	6.47E-01	5.97E-01
51	5.08E-01	5.08E-01	5.08E-01	5.08E-01	5.08E-01	5.13E-01	5.08E-01
<b>Biased Statistics</b>							
Average Biased	5.21E-01	5.59E-01	5.74E-01	5.98E-01	6.26E-01	6.30E-01	6.12E-01
Std Dev Biased	9.18E-03	1.41E-02	2.26E-02	2.13E-02	2.68E-02	3.11E-02	2.30E-02
Ps90%/90% (+KTL) Biased	5.46E-01	5.97E-01	6.36E-01	6.56E-01	7.00E-01	7.15E-01	6.75E-01
Ps90%/90% (-KTL) Biased	4.96E-01	5.20E-01	5.12E-01	5.39E-01	5.53E-01	5.45E-01	5.49E-01
<b>Un-Biased Statistics</b>							
Average Un-Biased	5.26E-01	5.72E-01	5.97E-01	6.22E-01	6.56E-01	6.54E-01	6.12E-01
Std Dev Un-Biased	2.67E-02	2.94E-02	3.43E-02	3.96E-02	4.84E-02	4.70E-02	3.23E-02
Ps90%/90% (+KTL) Un-Biased	6.00E-01	6.53E-01	6.91E-01	7.31E-01	7.89E-01	7.83E-01	7.00E-01
Ps90%/90% (-KTL) Un-Biased	4.53E-01	4.91E-01	5.03E-01	5.13E-01	5.24E-01	5.25E-01	5.23E-01
<b>Specification MIN</b>	<b>3.00E-01</b>	<b>3.00E-01</b>	<b>3.00E-01</b>	<b>3.00E-01</b>	<b>3.00E-01</b>	<b>3.00E-01</b>	<b>3.00E-01</b>
Status	PASS	PASS	PASS	PASS	PASS	PASS	PASS



## **6.0. Summary / Conclusions**

The low dose rate testing described in this final report was performed using the facilities at Aeroflex RAD's Longmire Laboratories in Colorado Springs, CO. The low dose rate source is a GB-150 irradiator modified to provide a panoramic exposure. The Co-60 rods are held in the base of the irradiator heavily shielded by lead. During the irradiation exposures the rod is raised by an electronic timer/controller and the exposure is performed in air. The dose rate for this irradiator in this configuration ranges from approximately 1mrad(Si)/s to a maximum of approximately 50rad(Si)/s, determined by the distance from the source.

The parametric data was obtained as "read and record" and all the raw data plus an attributes summary are contained in this report as well as in a separate Excel file. The attributes data contains the average, standard deviation and the average with the KTL values applied. The KTL value used in this work is 2.742 per MIL-HDBK-814 using one sided tolerance limits of 90/90 and a 5-piece sample size. The 90/90 KTL values were selected to match the statistical levels specified in the MIL-PRF-38535 sampling plan for the qualification of a radiation hardness assured (RHA) component. Note that the following criteria must be met for a device to pass the low dose rate test: following the radiation exposure each of the 5 pieces irradiated under electrical bias shall pass the specification value. The units irradiated without electrical bias and the KTL statistics are included in this report for reference only. If any of the 5 pieces irradiated under electrical bias exceed the device post radiation data sheet specification limits, then the lot could be logged as a failure.

Based on this criterion the RH117K Positive Adjustable Regulator (from the lot traceability information provided on the first page of this test report) PASSED the enhanced low dose rate sensitivity test to the maximum tested dose level of 50krad(Si) with all parameters remaining within their datasheet specifications.



**Appendix A: Photograph of Packing Label and a Sample Unit-Under-Test to Show Part Traceability**

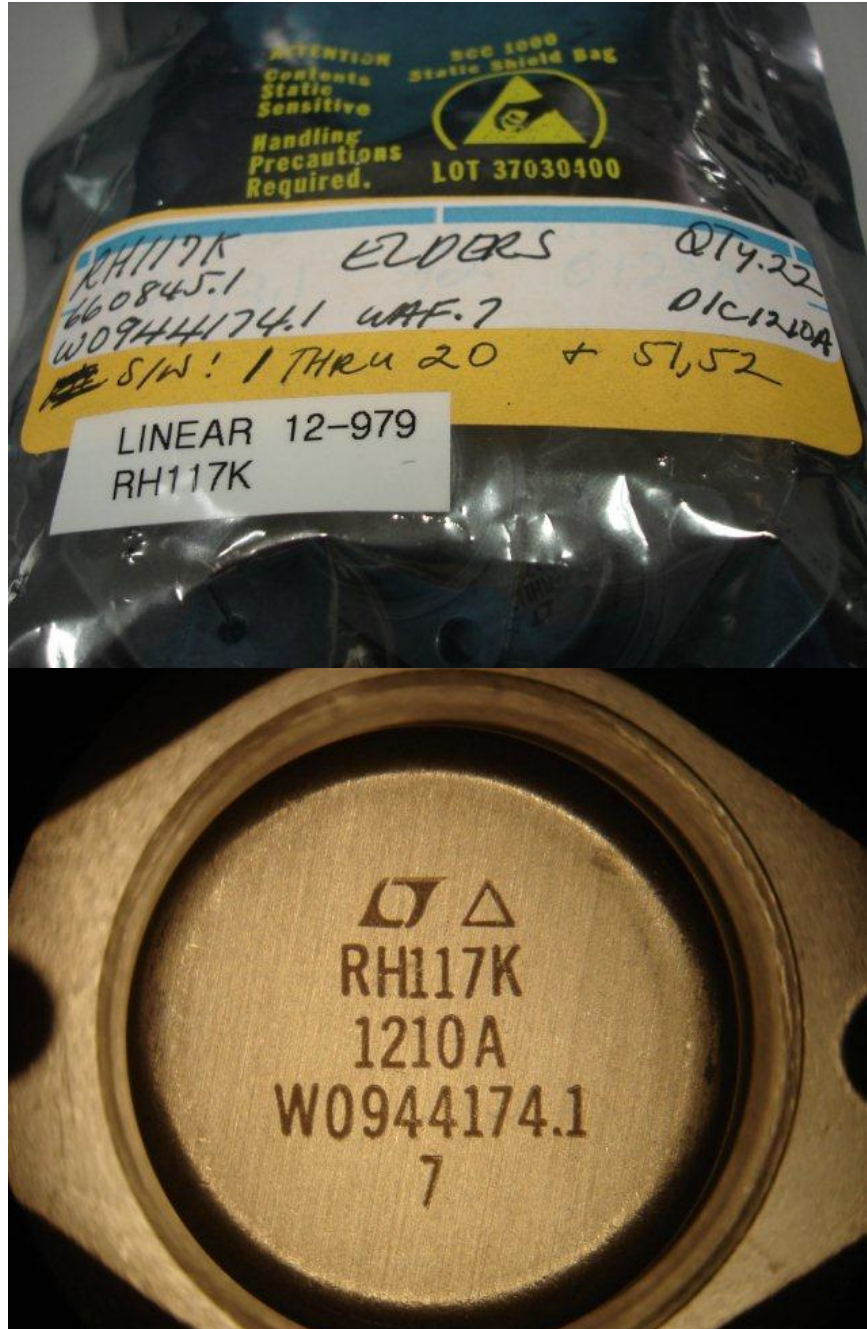

**Appendix B: Radiation Bias Connections and Absolute Maximum Ratings**

**ELDRS Radiation Biased Conditions:** Extracted from Linear Technology Linear Technology RH117 Datasheet Revision B.

Pin	Function	Connection / Bias
1	ADJUST	2kΩ Resistor To -15V
2	INPUT	To 15V, 0.1μF decoupling To -15V
3 (Case)	OUTPUT	61.9Ω Resistor To -15V

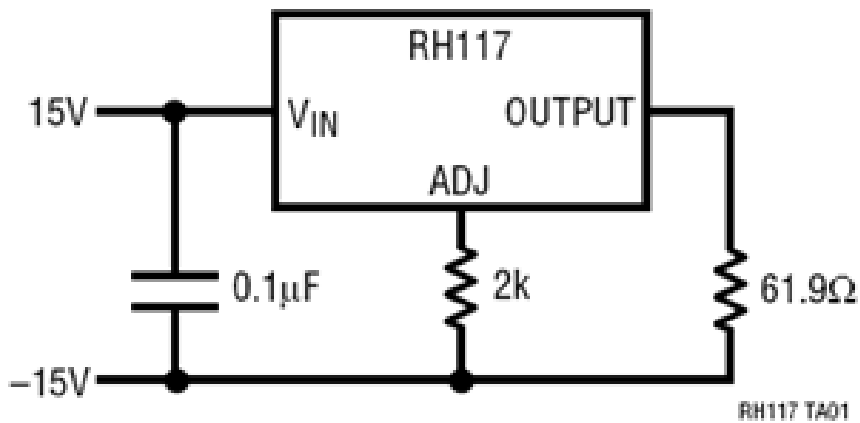

Figure B.1. Irradiation bias circuit. This figure was extracted from Linear Technology Linear Technology RH117 Datasheet Revision B.





**ELDRS Radiation Unbiased Conditions:** All Pins grounded

Pin	Function	Connection / Bias
1	ADJUST	GND
2	INPUT	GND
3 (Case)	OUTPUT	GND

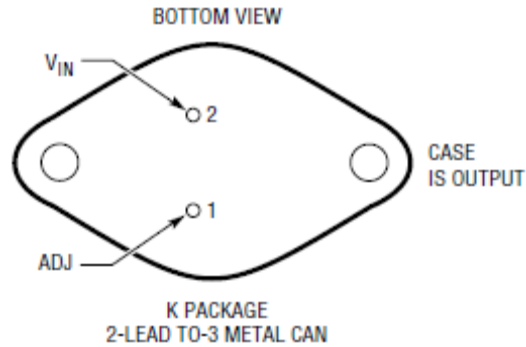

Figure B.2. K Package drawing (for reference only). This figure was extracted from Linear Technology Linear Technology RH117 Datasheet Revision B.

**Absolute Maximum Ratings:**

Parameter	Max Rating
Power Dissipation	Internally Limited
Input-to-output Differential	40V



### ***Appendix C: Electrical Test Parameters and Conditions***

The expected ranges of values as well as the measurement conditions are taken from Linear Technology Linear Technology RH117 Datasheet Revision B. All electrical tests for this device are performed on one of Aeroflex RAD's LTS2020 Test Systems. The LTS2020 Test System is a programmable parametric tester that provides parameter measurements for a variety of digital, analog and mixed signal products including voltage regulators, voltage comparators, D to A and A to D converters. The LTS2020 Test System achieves accuracy and sensitivity through the use of software self-calibration and an internal relay matrix with separate family boards and custom personality adapter boards. The tester uses this relay matrix to connect the required test circuits, select the appropriate voltage / current sources and establish the needed measurement loops for all the tests performed. The measured parameters and test conditions are shown in Table C.1.

A listing of the measurement precision/resolution for each parameter is shown in Table C.2. The precision/resolution values were obtained from test data or from the DAC resolution of the LTS-2020 for the particular test shown, whichever is greater. To generate the precision/resolution shown in Table C.2, one of the units-under-test was tested repetitively (a total of 10-times with re-insertion between tests) to obtain the average test value and standard deviation. Using this test data MIL-HDBK-814 90/90 KTL statistics were applied to the measured standard deviation to generate the final measurement range. This value encompasses the precision/resolution of all aspects of the test system, including the LTS2020 mainframe, family board, socket assembly and DUT board as well as insertion error. In some cases, the measurement resolution is limited by the internal DACs, which results in a measured standard deviation of zero. In these instances the precision/resolution will be reported back as the LSB of the DAC.

Note that the testing and statistics used in this document are based on an “analysis of variables” technique, which relies on small sample sizes to qualify much larger lot sizes (see MIL-HDBK-814, p. 91 for a discussion of statistical treatments). Not all measured parameters are well suited to this approach due to inherent large variations. If necessary, larger samples sizes could be used to qualify these parameters using an “attributes” approach.



Table C.1. Measured parameters and test conditions for the RH117K Positive Adjustable Regulator.

<b>Parameter</b>	<b>Symbol</b>	<b>Test Conditions</b>
Reference Voltage 1 (V)	VREF1	VDIFF=3V, IL=10mA
Reference Voltage 2 (V)	VREF2	VDIFF=40V, IL=10mA
Reference Voltage 3 (V)	VREF3	VDIFF=3V, IL=1.5A
Reference Voltage 4 (V)	VREF4	VDIFF=40V, IL=0.3A
Line Regulation (%/V)	LINE REG	VDIFF=3V TO 40V, IL=10mA
Load Regulation 1 (V)	LOAD REG1	VOUT<=5V, IL=10mA TO 1.5A
Load Regulation 2 (%)	LOAD REG2	VOUT>=5V, IL=10mA TO 1.5A
Adjust Pin Current 1 (A)	IADJ1	VDIFF=2.5V, IL=10mA
Adjust Pin Current 2 (A)	IADJ2	VDIFF=5V, IL=10mA
Adjust Pin Current 3 (A)	IADJ3	VDIFF=40V, IL=10mA
Adjust Pin Current Change 1 (A)	$\Delta$ IADJ1	VDIFF=5V, IL=10mA TO 1.5A
Adjust Pin Current Change 2 (A)	$\Delta$ IADJ2	VDIFF=2.5V TO 40V, IL=10mA
Minimum Load Current (A)	IMIN	VDIFF=40V
Current Limit 1 (A)	ISC1	VIN-VOUT=15V
Current Limit 2 (A)	ISC2	VIN-VOUT=40V



**ELDRS Report  
12-979 130327 R1.0**

**Aeroflex RAD  
5017 N. 30th Street  
Colorado Springs, CO 80919  
(719) 531-0800**

Table C.2. Measured parameters, pre-irradiation specifications and measurement precision for the RH117K Positive Adjustable Regulator.

Parameter	Pre-Irradiation Specification		Measurement Precision/Resolution
	MIN	MAX	
Reference Voltage 1 (V)	1.20E+00	1.30E+00	±8.71E-04
Reference Voltage 2 (V)	1.20E+00	1.30E+00	±6.53E-04
Reference Voltage 3 (V)	1.20E+00	1.30E+00	±6.53E-04
Reference Voltage 4 (V)	1.20E+00	1.30E+00	±8.71E-04
Line Regulation (%/V)		2.00E-02	±2.27E-04
Load Regulation 1 (V)		1.50E-02	±1.65E-04
Load Regulation 2 (%)	-3.00E-01	3.00E-01	±1.82E-02
Adjust Pin Current 1 (A)		1.00E-04	±3.75E-07
Adjust Pin Current 2 (A)		1.00E-04	±3.67E-07
Adjust Pin Current 3 (A)		1.00E-04	±2.01E-07
Adjust Pin Current Change 1 (A)	-5.00E-06	5.00E-06	±6.01E-07
Adjust Pin Current Change 2 (A)	-5.00E-06	5.00E-06	±2.66E-07
Minimum Load Current (A)		5.00E-03	±1.71E-05
Current Limit 1 (A)	1.50E+00		±7.59E-03
Current Limit 2 (A)	3.00E-01		±7.69E-03



***Appendix D: List of Figures Used in the Results Section (Section 5)***

- 5.1. Reference Voltage 1 (V) @  $V_{DIFF}=3V$ ,  $I_L=10mA$
- 5.2. Reference Voltage 2 (V) @  $V_{DIFF}=40V$ ,  $I_L=10mA$
- 5.3. Reference Voltage 3 (V) @  $V_{DIFF}=3V$ ,  $I_L=1.5A$
- 5.4. Reference Voltage 4 (V) @  $V_{DIFF}=40V$ ,  $I_L=0.3A$
- 5.5. Line Regulation (%/V) @  $V_{DIFF}=3V$  TO  $40V$ ,  $I_L=10mA$
- 5.6. Load Regulation 1 (V) @  $V_{OUT}\leq 5V$ ,  $I_L=10mA$  TO  $1.5A$
- 5.7. Load Regulation 2 (%) @  $V_{OUT}\geq 5V$ ,  $I_L=10mA$  TO  $1.5A$
- 5.8. Adjust Pin Current 1 (A) @  $V_{DIFF}=2.5V$ ,  $I_L=10mA$
- 5.9. Adjust Pin Current 2 (A) @  $V_{DIFF}=5V$ ,  $I_L=10mA$
- 5.10. Adjust Pin Current 3 (A) @  $V_{DIFF}=40V$ ,  $I_L=10mA$
- 5.11. Adjust Pin Current Change 1 (A) @  $V_{DIFF}=5V$ ,  $I_L=10mA$  TO  $1.5A$
- 5.12. Adjust Pin Current Change 2 (A) @  $V_{DIFF}=2.5V$  TO  $40V$ ,  $I_L=10mA$
- 5.13. Minimum Load Current (A) @  $V_{DIFF}=40V$
- 5.14. Current Limit 1 (A) @  $V_{IN}-V_{OUT}=15V$
- 5.15. Current Limit 2 (A) @  $V_{IN}-V_{OUT}=40V$