



***Enhanced Low Dose Rate Sensitivity (ELDRS) Radiation Testing of the  
RH1014MW Quad Operational Amplifier for Linear Technology***

**Customer:** Linear Technology (PO 50546L)

**RAD Job Number:** 08-199

**Part Type Tested:** Linear Technology RH1014MW Quad Operational Amplifier

**Commercial Part Number:** RH1014MW

**Traceability Information:** Lot Date Code: 0737A, Fab Run # W10722836.1, W04, Assy Lot #446548.1

**Quantity of Units:** 11 units total, 5 units for biased irradiation, 5 units for unbiased irradiation and 1 control unit.

**External Traveler:** None required

**Pre-Irradiation Burn-In:** Burn-In performed by Linear Technology prior to receipt by RAD, Inc.

**TID Dose Rate and Maximum Total Dose:** 10mrad(Si)/s to 50krad(Si) total ionizing dose

**TID Test Increments:** Pre-Irradiation, 10krad(Si), 20krad(Si), 30krad(Si) and 50krad(Si)

**TID Overtest and Post-Irradiation Anneal:** No overtest. 24-hour room temperature anneal followed by a 168-hour 100°C anneal. Both anneals were performed in the same electrical bias condition as the irradiations. Electrical measurements were made following each anneal increment.

**TID Test Standard:** MIL-STD-883G, Method 1019.7, Condition D

**TID Electrical Test Conditions:** Pre-irradiation, and within one hour following each radiation exposure.

**Hardware and Test Program:** LTS2020 Tester, 2101 Family Board, 0600 Fixture and RH1014 DUT Board (BGSS-970312B), RH1014L3.SRC

**TID Bias Conditions:** Serial numbers 1027, 1029, 1030, 1031 and 1032 were biased during irradiation, serial numbers 1033, 1034, 1035, 1036, and 1038 were unbiased during irradiation and serial number 1039 was used as the control.

**Facility:** Radiation Assured Devices Longmire Laboratories, Colorado Springs, CO

**Radiation Sources:** Co60 (Gamma Beam 150)

**Irradiation and Test Temperature:** Ambient, room temperature controlled to 24°C ± 6°C

**ELDRS Test Result: PASSED. All parts met datasheet specifications to  
50krad(Si) with no substantial degradation to any measured parameter**



## **1.0. Overview and Background**

It is well known that total dose ionizing radiation can cause parametric degradation and ultimately functional failure in electronic devices. The damage occurs via electron-hole pair production, transport and trapping in the dielectric regions. In advanced CMOS technology nodes (0.6 $\mu$ m and smaller) the bulk of the damage is manifested in the thicker isolation regions, such as shallow trench or local oxidation of silicon (LOCOS) oxides (also known as “birds-beak” oxides). However, many linear and mixed signal devices that utilize bipolar minority carrier elements exhibit an enhanced low dose rate sensitivity (ELDRS). At this time there is no known or accepted *a priori* method for predicting susceptibility to ELDRS or simulating the low dose rate sensitivity with a “conventional” room temperature 50-300rad(Si)/s irradiation (Condition A in MIL-STD-883G TM 1019.7). Over the past 10 years a number of accelerating techniques have been examined, including an elevated temperature anneal, such as that used for MOS devices (see ASTM-F-1892 for more technical details) and irradiating at various temperatures. However, none of these techniques have proven useful across the wide variety of linear and/or mixed signal devices used in spaceborne applications.

The latest requirement incorporated in MIL-STD-883G TM 1019.7 requires that devices that could potentially exhibit ELDRS “shall be tested either at the intended application dose rate, at a prescribed low dose rate to an overtest radiation level, or with an accelerated test such as an elevated temperature irradiation test that includes a parameter delta design margin”. While the recently released MIL-STD-883 TM 1019.7 allows for accelerated testing, the requirements for this are to essentially perform a low dose rate ELDRS test to verify the suitability of the acceleration method on the component of interest before the acceleration technique can be instituted. Based on the limitations of accelerated testing and to meet the requirements of MIL-STD-883G TM 1019.7 Condition D, we have performed an ELDRS test at 10mrad(Si)/s.

## **2.0. Radiation Test Apparatus**

The ELDRS testing described in this final report was performed using the facilities at Radiation Assured Devices’ Longmire Laboratories in Colorado Springs, CO. The ELDRS source is a GB-150 irradiator modified to provide a panoramic exposure. The Co-60 rods are held in the base of the irradiator heavily shielded by lead. During the irradiation exposures the rod is raised by an electronic timer/controller and the exposure is performed in air. The dose rate for this irradiator in this configuration ranges from approximately 1mrad(Si)/s to a maximum of approximately 50rad(Si)/s as determined by the distance from the source. For the low dose rate ELDRS testing described in this report, the devices are placed approximately 2-meters from the Co-60 rods. The irradiator calibration is maintained by Radiation Assured Devices’ Longmire Laboratories using thermoluminescent dosimeters (TLDs) traceable to the National Institute of Standards and Technology (NIST). Figure 2.1 shows a photograph of the Co-60 irradiator at RAD’s Longmire Laboratory facility.



Figure 2.1. Radiation Assured Devices' Co-60 irradiator. The dose rate is obtained by positioning the device-under-test at a fixed distance from the gamma cell. The dose rate for this irradiator varies from approximately 50rad(Si)/s close to the rods down to <1mrad(Si)/s at a distance of approximately 4-meters.



### **3.0. Radiation Test Conditions**

The RH1014MW quad operational amplifier described in this final report was tested using two bias conditions, statically biased with a split 15V supply and all pins tied to ground, see Appendix A for details on biasing conditions. These devices were irradiated to a maximum total ionizing dose level of 50krad(Si) with incremental readings at 10, 20, 30 and 50krad(Si). Electrical testing occurred within one hour following the end of each irradiation segment. For intermediate irradiations, the units were tested and returned to total dose exposure within two hours from the end of the previous radiation increment. The ELDRS bias board was positioned in the Co-60 cell to provide the required 10mrad(Si)/s and was located inside a lead-aluminum box. The lead-aluminum box is required under MIL-STD-883G TM1019.7 Section 3.4 that reads as follows: “Lead/Aluminum (Pb/Al) container. Test specimens shall be enclosed in a Pb/Al container to minimize dose enhancement effects caused by low-energy, scattered radiation. A minimum of 1.5 mm Pb, surrounding an inner shield of at least 0.7 mm Al, is required. This Pb/Al container produces an approximate charged particle equilibrium for Si and for TLDs such as CaF<sub>2</sub>. The radiation field intensity shall be measured inside the Pb/Al container (1) initially, (2) when the source is changed, or (3) when the orientation or configuration of the source, container, or test-fixture is changed. This measurement shall be performed by placing a dosimeter (e.g., a TLD) in the device-irradiation container at the approximate test-device position. If it can be demonstrated that low energy scattered radiation is small enough that it will not cause dosimetry errors due to dose enhancement, the Pb/Al container may be omitted”.

The final dose rate within the lead-aluminum box was determined based on TLD dosimetry measurements just prior to the beginning of the total dose irradiations. The final dose rate for this work was 10.0mrad(Si)/s with a precision of  $\pm 5\%$ .



#### 4.0. Tested Parameters

The following parameters were tested during the course of this work:

1. Positive Supply Current ( $I_{CC+}$ )
2. Negative Supply Current ( $I_{EE-}$ )
3. Input Offset Voltage ( $V_{OS1}-V_{OS4}$ )
4. Input Offset Current ( $I_{OS1}-I_{OS4}$ )
5. + Input Bias Current ( $I_{B+1}-I_{B+4}$ )
6. - Input Bias Current ( $I_{B-1}-I_{B-4}$ )
7. Common Mode Rejection Ratio (CMRR1-CMRR4)
8. Power Supply Rejection Ratio (PSRR1-PSRR4)
9. Large Signal Voltage Gain (AVOL9-AVOL12)
10. Positive Output Voltage Swing ( $V_{OUT+1}-V_{OUT+4}$ )
11. Negative Output Voltage Swing ( $V_{OUT-1}-V_{OUT-4}$ )
12. Positive Slew Rate (SlewRate+1-SlewRate+4)
13. Negative Slew Rate (SlewRate-1-SlewRate-4)
14. Positive Supply Current ( $I_{CC+2}$ )
15. Negative Supply Current ( $I_{EE-2}$ )
16. Input Offset Voltage ( $V_{OS5}-V_{OS8}$ )
17. Input Offset Current ( $I_{OS5}-I_{OS8}$ )
18. + Input Bias Current ( $I_{B+5}-I_{B+8}$ )
19. - Input Bias Current ( $I_{B-5}-I_{B-8}$ )
20. Positive Output Voltage Swing ( $V_{OUT+5}-V_{OUT+8}$ )
21. Positive Output Voltage Swing ( $V_{OUT+9}-V_{OUT+12}$ )
22. Negative Output Voltage Swing ( $V_{OUT-5}-V_{OUT-8}$ )
23. Negative Output Voltage Swing ( $V_{OUT-9}-V_{OUT-12}$ )
24. Negative Output Voltage Swing ( $V_{OUT-13}-V_{OUT-16}$ )

Appendix C details the measured parameters, test conditions, pre-irradiation specification and measurement resolution for each of the measurements.

The parametric data was obtained as “read and record” and all the raw data plus an attributes summary are contained in this report as well as in a separate Excel file. The attributes data contains the average, standard deviation and the average with the KTL values applied. The KTL values used is 2.742 per MIL HDBK 814 using one sided tolerance limits of 90/90 and a 5-piece sample size. This survival probability/level of confidence is consistent with a 22-piece sample size and zero failures analyzed using a lot tolerance percent defective (LTPD) approach. Note that the following criteria must be met for a device to pass the ELDRS testing: following the radiation exposure the unit shall pass the specification value and the average value for the each device must pass the specification value when the KTL limits are applied. If either of these conditions is not satisfied following the radiation exposure, then the lot could be logged as an RLAT failure.



Further, MIL-STD-883G, TM 1019.7 Section 3.13.1.1 Characterization test to determine if a part exhibits ELDRS” states the following: Select a minimum random sample of 21 devices from a population representative of recent production runs. Smaller sample sizes may be used if agreed upon between the parties to the test. All of the selected devices shall have undergone appropriate elevated temperature reliability screens, e.g. burn-in and high temperature storage life. Divide the samples into four groups of 5 each and use the remaining part for a control. Perform pre-irradiation electrical characterization on all parts assuring that they meet the Group A electrical tests. Irradiate 5 samples under a 0 volt bias and another 5 under the irradiation bias given in the acquisition specification at 50-300 rad(Si)/s and room temperature. Irradiate 5 samples under a 0 volt bias and another 5 under irradiation bias given in the acquisition specification at < 10mrad(Si)/s and room temperature. Irradiate all samples to the same dose levels, including 0.5 and 1.0 times the anticipated specification dose, and repeat the electrical characterization on each part at each dose level. Post irradiation electrical measurements shall be performed per paragraph 3.10 where the low dose rate test is considered Condition D. Calculate the radiation induced change in each electrical parameter ( $\Delta$ para) for each sample at each radiation level. Calculate the ratio of the median  $\Delta$ para at low dose rate to the median  $\Delta$ para at high dose rate for each irradiation bias group at each total dose level. If this ratio exceeds 1.5 for any of the most sensitive parameters then the part is considered to be ELDRS susceptible. This test does not apply to parameters which exhibit changes that are within experimental error or whose values are below the pre-irradiation electrical specification limits at low dose rate at the specification dose.

Therefore, the data in this report can be analyzed along with the high dose rate report titled “Radiation Lot Acceptance Testing (RLAT) of the RH1014MW Quad Operational Amplifier for Linear Technology” to demonstrate that these parts do not exhibit ELDRS as defined in the current test method.

## **5.0. ELDRS Test Results**

Using the conditions stated above, the RH1014MW devices passed the ELDRS test to 50krad(Si) with no significant degradation to most of the measured parameters. Where radiation induced degradation was observed the degradation was not sufficient to cause the parameter to exceed the specification value.

Figures 5.1 through 5.84 show plots of all the measured parameters versus total ionizing dose. In the data plots the solid diamonds are the average of the measured data points for the sample irradiated under electrical bias while the shaded diamonds are the average of the measured data points for the units irradiated with all pins tied to ground. The black lines (solid or dashed) are the average of the data points after application of the KTL statistics on the sample irradiated in the biased condition while the shaded lines (solid or dashed) are the average of the data points after application of the KTL statistics on the sample irradiated in the unbiased condition. The red dotted line(s) are the pre- and/or post-irradiation minimum and/or maximum specification value as defined in the datasheet and/or test plan.



Tables 5.1 through 5.84 show the raw data, averages, standard deviation, +KTL statistics, -KTL statistics, specification limit and Pass/Fail condition for each parameter. Appendix D provides a list of all the figures in this results section to facilitate the location of a particular parameter.

As seen clearly in these tables and figures, the pre- and post-irradiation data are well within the specification even after application of the KTL statistics (with certain exceptions, as noted below). The control units, as expected, show no significant changes to any of the parameters. Therefore we can conclude that the electrical testing remained under control during the course of the testing.

Note that the testing and statistics used in this document are based on an “analysis of variables” technique, which relies on small sample sizes to qualify much larger lot sizes (see MIL-HDBK-814, p. 91 for a discussion of statistical treatments). Unfortunately, not all measured parameters are well suited to this approach due to inherent large variations. The parameters measured in this report where the pre-irradiation KTL values are out of specification include Common Mode Rejection Ratio, Power Supply Rejection Ratio and Open Loop Gain, where the device exhibits extreme sensitivity to input conditions, resulting in a very large standard deviation and a statistical error often greater than the measured value. If necessary, larger samples sizes could be used to qualify these parameters using an “attributes” approach.

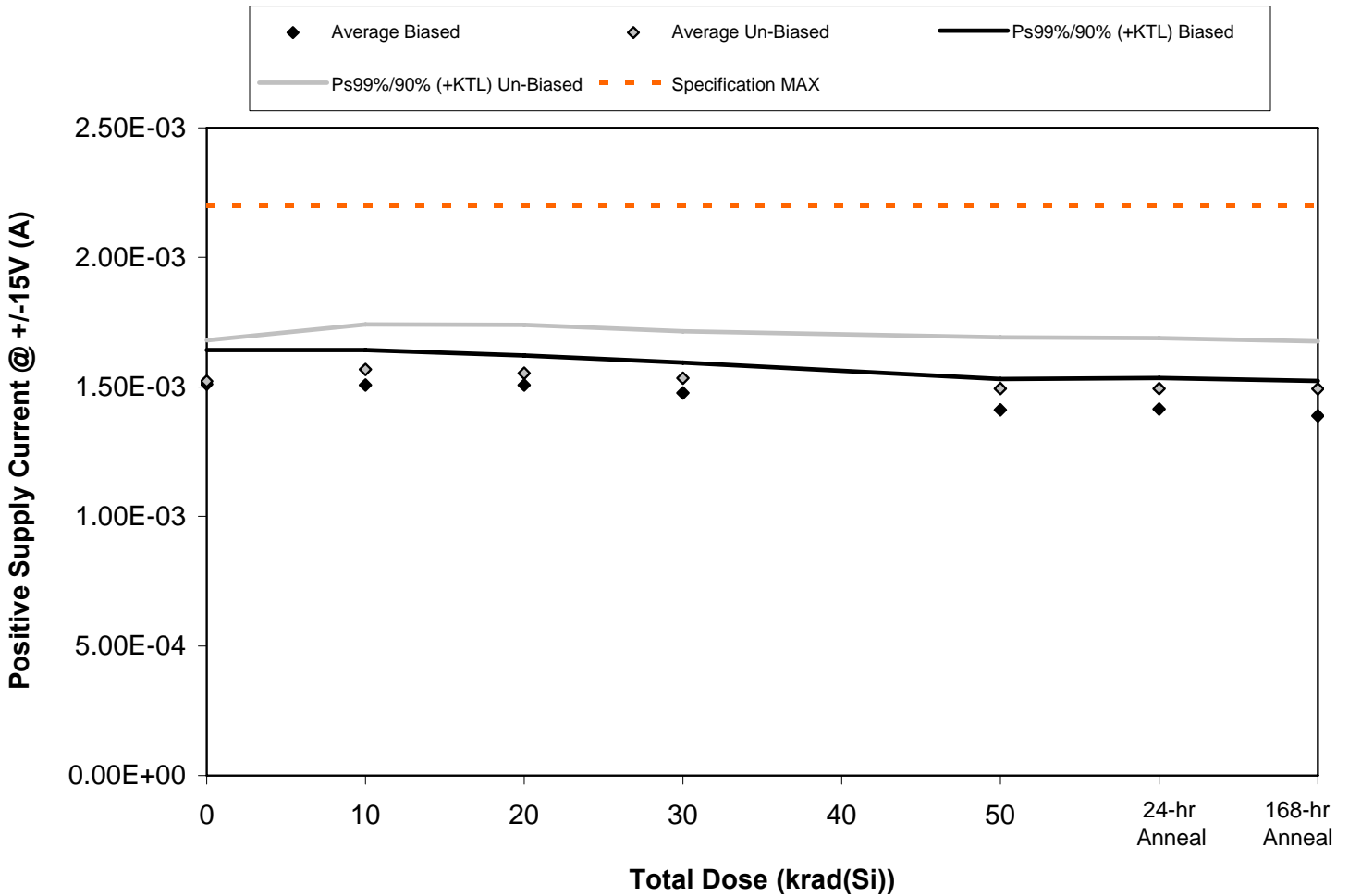

Figure 5.1. Plot of Positive Supply Current @ +/-15V (A) versus total dose. The data show no significant degradation with radiation. The solid diamonds are the average of measured data points from the biased sample (devices irradiated with an electrical bias) while the shaded diamonds are the average from the unbiased sample. The black lines show the effects on the data after application of the biased KTL statistics (solid and dashed lines) while the gray lines show the effects on the data after application of the unbiased KTL statistics (solid and dashed lines). The red dashed lines are the minimum and maximum specification values as defined in the datasheet and/or test plan.





Table 5.1. Raw data for Positive Supply Current @ +/-15V (A) versus total dose, including the statistical analysis, the specification and the status of the testing (pass/fail).

Positive Supply Current @ +/-15V (A)	Total Dose (krad(Si))					24-hr Anneal	168-hr Anneal
	0	10	20	30	50		
Device							
1027	1.56E-03	1.55E-03	1.55E-03	1.52E-03	1.45E-03	1.46E-03	1.44E-03
1029	1.48E-03	1.47E-03	1.48E-03	1.45E-03	1.39E-03	1.39E-03	1.36E-03
1030	1.51E-03	1.50E-03	1.51E-03	1.46E-03	1.40E-03	1.40E-03	1.37E-03
1031	1.50E-03	1.50E-03	1.50E-03	1.48E-03	1.41E-03	1.41E-03	1.39E-03
1032	1.50E-03	1.50E-03	1.50E-03	1.48E-03	1.41E-03	1.41E-03	1.38E-03
1033	1.49E-03	1.53E-03	1.52E-03	1.50E-03	1.46E-03	1.46E-03	1.46E-03
1034	1.58E-03	1.63E-03	1.62E-03	1.60E-03	1.56E-03	1.56E-03	1.56E-03
1035	1.52E-03	1.57E-03	1.56E-03	1.54E-03	1.50E-03	1.50E-03	1.50E-03
1036	1.52E-03	1.56E-03	1.55E-03	1.53E-03	1.49E-03	1.49E-03	1.49E-03
1038	1.50E-03	1.54E-03	1.52E-03	1.51E-03	1.46E-03	1.46E-03	1.47E-03
1039	1.55E-03	1.56E-03	1.56E-03	1.56E-03	1.55E-03	1.55E-03	1.56E-03
<b>Biased Statistics</b>							
Average Biased	1.51E-03	1.51E-03	1.51E-03	1.48E-03	1.41E-03	1.41E-03	1.39E-03
Std Dev Biased	2.82E-05	2.89E-05	2.44E-05	2.50E-05	2.54E-05	2.57E-05	2.89E-05
Ps99%/90% (+KTL) Biased	1.64E-03	1.64E-03	1.62E-03	1.59E-03	1.53E-03	1.53E-03	1.52E-03
Ps99%/90% (-KTL) Biased	1.38E-03	1.37E-03	1.39E-03	1.36E-03	1.29E-03	1.29E-03	1.25E-03
<b>Un-Biased Statistics</b>							
Average Un-Biased	1.52E-03	1.57E-03	1.55E-03	1.53E-03	1.49E-03	1.49E-03	1.49E-03
Std Dev Un-Biased	3.38E-05	3.73E-05	4.01E-05	3.90E-05	4.25E-05	4.18E-05	3.92E-05
Ps99%/90% (+KTL) Un-Biased	1.68E-03	1.74E-03	1.74E-03	1.72E-03	1.69E-03	1.69E-03	1.68E-03
Ps99%/90% (-KTL) Un-Biased	1.36E-03	1.39E-03	1.37E-03	1.35E-03	1.30E-03	1.30E-03	1.31E-03
<b>Specification MAX</b>	<b>2.20E-03</b>	<b>2.20E-03</b>	<b>2.20E-03</b>	<b>2.20E-03</b>	<b>2.20E-03</b>	<b>2.20E-03</b>	<b>2.20E-03</b>
Status	PASS	PASS	PASS	PASS	PASS	PASS	PASS

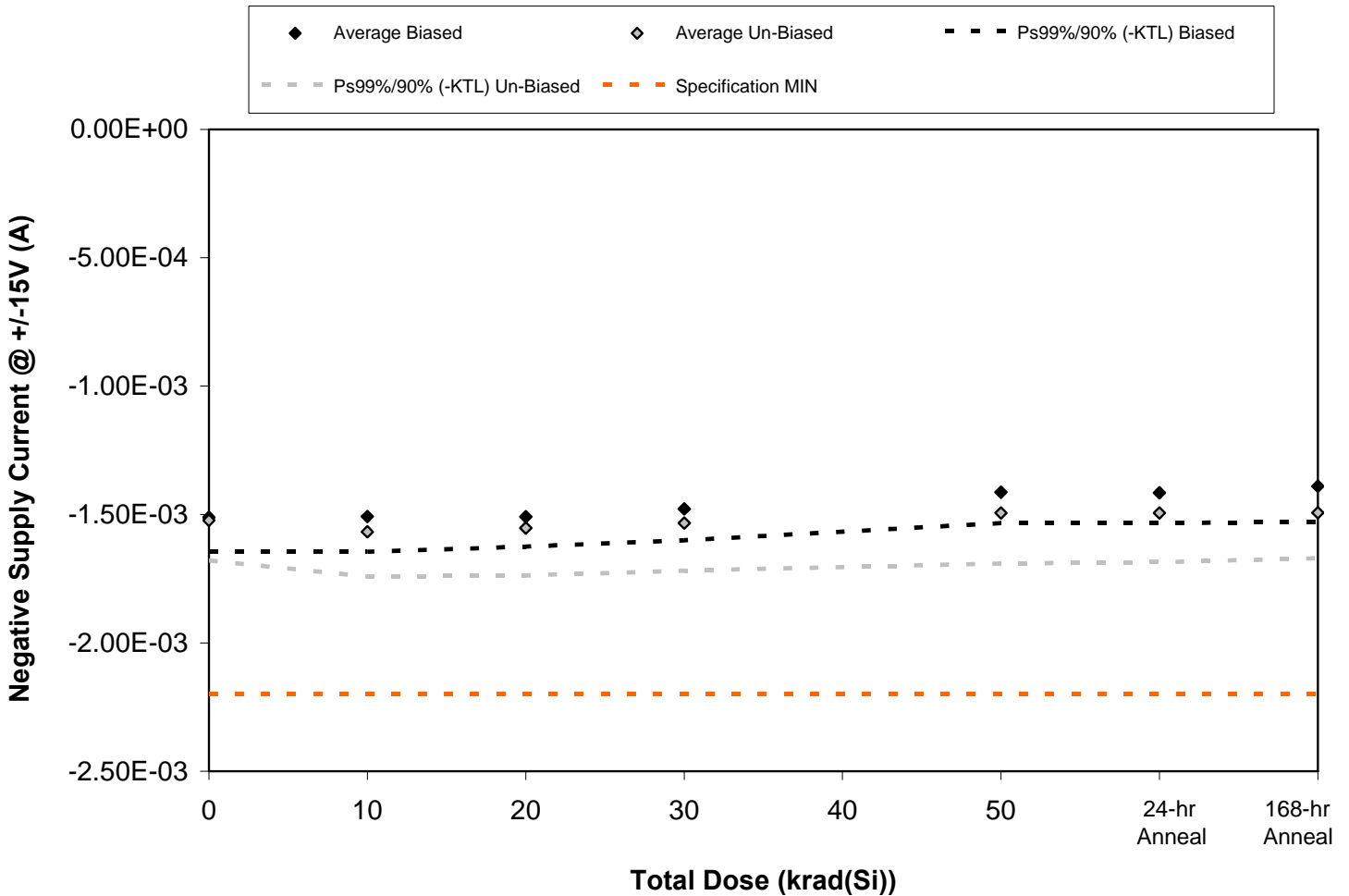

Figure 5.2. Plot of Negative Supply Current @ +/-15V (A) versus total dose. The data show no significant degradation with radiation. The solid diamonds are the average of measured data points from the biased sample (devices irradiated with an electrical bias) while the shaded diamonds are the average from the unbiased sample. The black lines show the effects on the data after application of the biased KTL statistics (solid and dashed lines) while the gray lines show the effects on the data after application of the unbiased KTL statistics (solid and dashed lines). The red dashed lines are the minimum and maximum specification values as defined in the datasheet and/or test plan.



Table 5.2. Raw data for Negative Supply Current @ +/-15V (A) versus total dose, including the statistical analysis, the specification and the status of the testing (pass/fail).

Negative Supply Current @ +/-15V (A)	Total Dose (krad(Si))					24-hr Anneal	168-hr Anneal
	0	10	20	30	50		
Device							
1027	-1.56E-03	-1.56E-03	-1.55E-03	-1.52E-03	-1.46E-03	-1.46E-03	-1.44E-03
1029	-1.48E-03	-1.48E-03	-1.48E-03	-1.45E-03	-1.39E-03	-1.39E-03	-1.36E-03
1030	-1.51E-03	-1.50E-03	-1.51E-03	-1.46E-03	-1.40E-03	-1.40E-03	-1.37E-03
1031	-1.50E-03	-1.51E-03	-1.51E-03	-1.48E-03	-1.41E-03	-1.42E-03	-1.39E-03
1032	-1.50E-03	-1.50E-03	-1.50E-03	-1.48E-03	-1.41E-03	-1.41E-03	-1.39E-03
1033	-1.49E-03	-1.53E-03	-1.52E-03	-1.50E-03	-1.46E-03	-1.46E-03	-1.46E-03
1034	-1.58E-03	-1.63E-03	-1.62E-03	-1.60E-03	-1.56E-03	-1.56E-03	-1.55E-03
1035	-1.52E-03	-1.57E-03	-1.56E-03	-1.54E-03	-1.50E-03	-1.51E-03	-1.50E-03
1036	-1.52E-03	-1.56E-03	-1.55E-03	-1.53E-03	-1.49E-03	-1.49E-03	-1.49E-03
1038	-1.50E-03	-1.54E-03	-1.53E-03	-1.51E-03	-1.47E-03	-1.46E-03	-1.47E-03
1039	-1.55E-03	-1.56E-03	-1.56E-03	-1.56E-03	-1.55E-03	-1.55E-03	-1.56E-03
<b>Biased Statistics</b>							
Average Biased	-1.51E-03	-1.51E-03	-1.51E-03	-1.48E-03	-1.41E-03	-1.42E-03	-1.39E-03
Std Dev Biased	2.83E-05	2.94E-05	2.49E-05	2.62E-05	2.58E-05	2.53E-05	2.96E-05
Ps99%/90% (+KTL) Biased	-1.38E-03	-1.37E-03	-1.39E-03	-1.36E-03	-1.29E-03	-1.30E-03	-1.25E-03
Ps99%/90% (-KTL) Biased	-1.64E-03	-1.65E-03	-1.62E-03	-1.60E-03	-1.53E-03	-1.53E-03	-1.53E-03
<b>Un-Biased Statistics</b>							
Average Un-Biased	-1.52E-03	-1.57E-03	-1.55E-03	-1.53E-03	-1.49E-03	-1.49E-03	-1.49E-03
Std Dev Un-Biased	3.36E-05	3.74E-05	3.95E-05	3.95E-05	4.22E-05	4.10E-05	3.80E-05
Ps99%/90% (+KTL) Un-Biased	-1.37E-03	-1.39E-03	-1.37E-03	-1.35E-03	-1.30E-03	-1.30E-03	-1.32E-03
Ps99%/90% (-KTL) Un-Biased	-1.68E-03	-1.74E-03	-1.74E-03	-1.72E-03	-1.69E-03	-1.69E-03	-1.67E-03
<b>Specification MIN</b>	<b>-2.20E-03</b>	<b>-2.20E-03</b>	<b>-2.20E-03</b>	<b>-2.20E-03</b>	<b>-2.20E-03</b>	<b>-2.20E-03</b>	<b>-2.20E-03</b>
Status	PASS	PASS	PASS	PASS	PASS	PASS	PASS

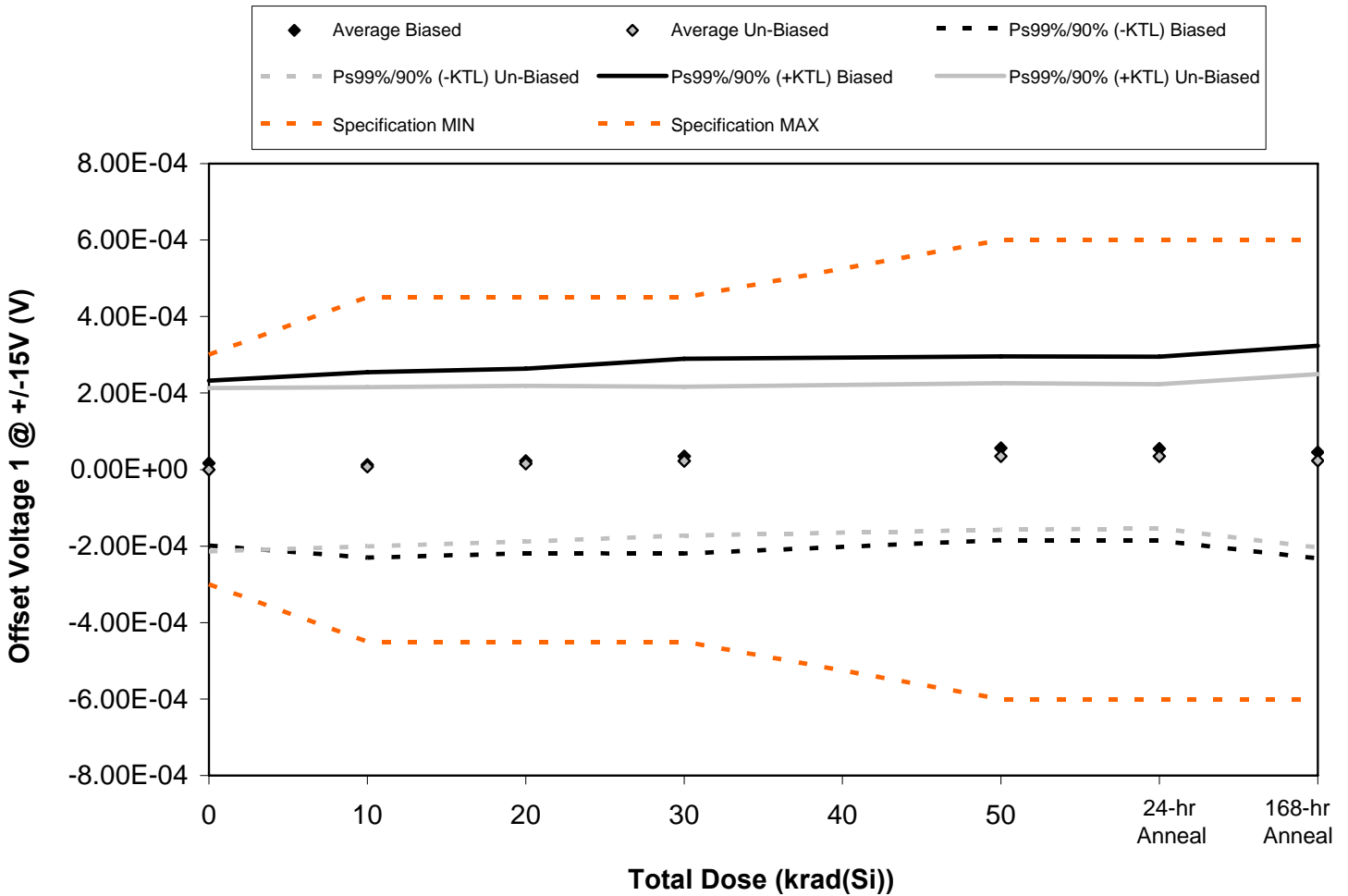

Figure 5.3. Plot of Offset Voltage 1 @ +/-15V (V) versus total dose. The data show no significant degradation with radiation. The solid diamonds are the average of measured data points from the biased sample (devices irradiated with an electrical bias) while the shaded diamonds are the average from the unbiased sample. The black lines show the effects on the data after application of the biased KTL statistics (solid and dashed lines) while the gray lines show the effects on the data after application of the unbiased KTL statistics (solid and dashed lines). The red dashed lines are the minimum and maximum specification values as defined in the datasheet and/or test plan.



Table 5.3. Raw data for Offset Voltage 1 @ +/-15V (V) versus total dose, including the statistical analysis, the specification and the status of the testing (pass/fail).

Offset Voltage 1 @ +/-15V (V)	Total Dose (krad(Si))					24-hr Anneal	168-hr Anneal
	0	10	20	30	50		
Device							
1027	8.40E-07	-1.20E-05	-3.70E-07	6.64E-06	2.86E-05	2.40E-05	1.56E-05
1029	2.14E-05	2.37E-05	3.23E-05	4.08E-05	5.83E-05	5.71E-05	4.83E-05
1030	8.05E-05	8.36E-05	9.26E-05	1.13E-04	1.24E-04	1.26E-04	1.27E-04
1031	-4.70E-05	-5.77E-05	-4.83E-05	-3.42E-05	-1.22E-05	-9.90E-06	-3.21E-05
1032	2.78E-05	2.32E-05	3.52E-05	4.70E-05	7.98E-05	7.60E-05	6.92E-05
1033	-4.59E-06	-3.70E-07	1.01E-05	2.14E-05	3.20E-05	3.25E-05	2.11E-05
1034	7.61E-05	8.24E-05	8.90E-05	9.22E-05	1.03E-04	1.03E-04	1.04E-04
1035	-2.06E-06	7.00E-06	1.38E-05	1.65E-05	3.11E-05	2.97E-05	1.91E-05
1036	-3.38E-05	-2.40E-05	-1.51E-05	-6.16E-06	6.03E-06	6.03E-06	-1.28E-05
1038	-3.73E-05	-2.85E-05	-1.98E-05	-1.26E-05	1.20E-07	2.05E-06	-1.68E-05
1039	3.86E-06	2.77E-06	-2.50E-07	0.00E+00	1.44E-06	2.17E-06	1.08E-06
<b>Biased Statistics</b>							
Average Biased	1.67E-05	1.21E-05	2.23E-05	3.47E-05	5.57E-05	5.46E-05	4.57E-05
Std Dev Biased	4.62E-05	5.20E-05	5.17E-05	5.46E-05	5.15E-05	5.15E-05	5.96E-05
Ps99%/90% (+KTL) Biased	2.32E-04	2.55E-04	2.64E-04	2.89E-04	2.96E-04	2.95E-04	3.24E-04
Ps99%/90% (-KTL) Biased	-1.99E-04	-2.31E-04	-2.19E-04	-2.20E-04	-1.85E-04	-1.86E-04	-2.32E-04
<b>Un-Biased Statistics</b>							
Average Un-Biased	-3.44E-07	7.29E-06	1.56E-05	2.23E-05	3.45E-05	3.46E-05	2.29E-05
Std Dev Un-Biased	4.57E-05	4.46E-05	4.36E-05	4.17E-05	4.11E-05	4.04E-05	4.86E-05
Ps99%/90% (+KTL) Un-Biased	2.13E-04	2.15E-04	2.19E-04	2.17E-04	2.26E-04	2.23E-04	2.49E-04
Ps99%/90% (-KTL) Un-Biased	-2.14E-04	-2.01E-04	-1.88E-04	-1.72E-04	-1.57E-04	-1.54E-04	-2.04E-04
<b>Specification MIN</b>	<b>-3.00E-04</b>	<b>-4.50E-04</b>	<b>-4.50E-04</b>	<b>-4.50E-04</b>	<b>-6.00E-04</b>	<b>-6.00E-04</b>	<b>-6.00E-04</b>
Status	PASS	PASS	PASS	PASS	PASS	PASS	PASS
<b>Specification MAX</b>	<b>3.00E-04</b>	<b>4.50E-04</b>	<b>4.50E-04</b>	<b>4.50E-04</b>	<b>6.00E-04</b>	<b>6.00E-04</b>	<b>6.00E-04</b>
Status	PASS	PASS	PASS	PASS	PASS	PASS	PASS

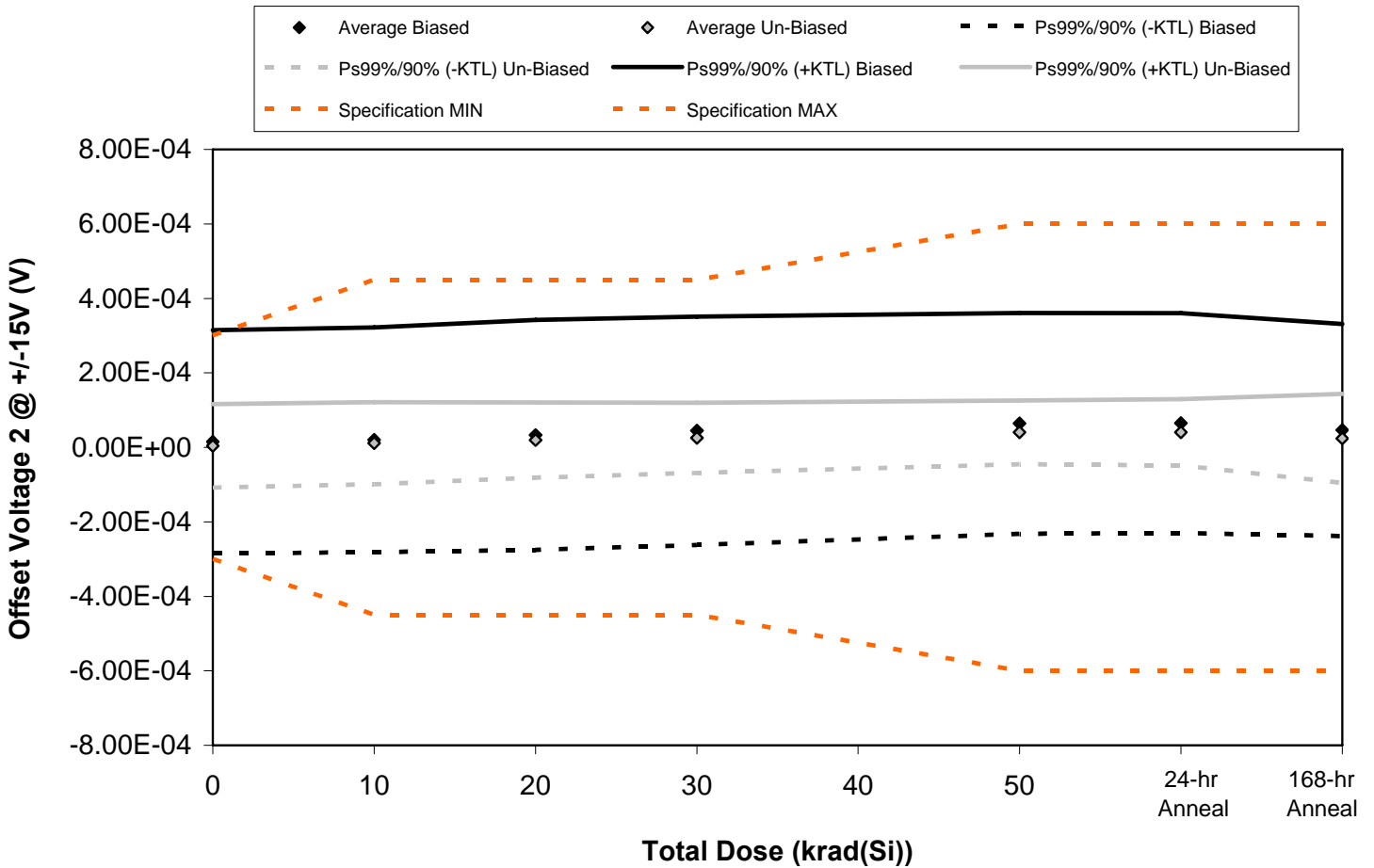

Figure 5.4. Plot of Offset Voltage 2 @ +/-15V (V) versus total dose. The data show no significant degradation with radiation. The solid diamonds are the average of measured data points from the biased sample (devices irradiated with an electrical bias) while the shaded diamonds are the average from the unbiased sample. The black lines show the effects on the data after application of the biased KTL statistics (solid and dashed lines) while the gray lines show the effects on the data after application of the unbiased KTL statistics (solid and dashed lines). The red dashed lines are the minimum and maximum specification values as defined in the datasheet and/or test plan.



Table 5.4. Raw data for Offset Voltage 2 @ +/-15V (V) versus total dose, including the statistical analysis, the specification and the status of the testing (pass/fail).

Offset Voltage 2 @ +/-15V (V)	Total Dose (krad(Si))					24-hr Anneal	168-hr Anneal
	0	10	20	30	50		
Device							
1027	-4.22E-05	-3.85E-05	-2.67E-05	-1.52E-05	6.87E-06	7.60E-06	-2.30E-06
1029	5.59E-05	6.56E-05	8.27E-05	9.16E-05	1.10E-04	1.09E-04	7.51E-05
1030	7.15E-05	7.81E-05	9.02E-05	1.03E-04	1.20E-04	1.20E-04	1.07E-04
1031	-6.74E-05	-6.08E-05	-4.99E-05	-3.76E-05	-1.51E-05	-1.44E-05	-3.39E-05
1032	5.54E-05	5.64E-05	6.96E-05	8.11E-05	1.00E-04	1.02E-04	8.61E-05
1033	-8.58E-06	-7.73E-06	2.30E-07	5.91E-06	2.12E-05	1.99E-05	-3.15E-06
1034	1.20E-06	6.64E-06	1.81E-05	2.76E-05	4.67E-05	4.68E-05	4.98E-05
1035	2.99E-05	3.44E-05	3.69E-05	3.97E-05	4.24E-05	4.43E-05	3.62E-05
1036	2.43E-05	3.67E-05	4.60E-05	4.97E-05	6.61E-05	6.72E-05	4.07E-05
1038	-2.86E-05	-1.46E-05	-2.66E-06	4.46E-06	2.41E-05	2.43E-05	-4.11E-06
1039	4.78E-05	4.89E-05	4.91E-05	4.95E-05	4.73E-05	4.84E-05	5.02E-05
<b>Biased Statistics</b>							
Average Biased	1.47E-05	2.02E-05	3.32E-05	4.46E-05	6.45E-05	6.50E-05	4.63E-05
Std Dev Biased	6.43E-05	6.47E-05	6.61E-05	6.57E-05	6.35E-05	6.33E-05	6.09E-05
Ps99%/90% (+KTL) Biased	3.15E-04	3.22E-04	3.42E-04	3.51E-04	3.61E-04	3.60E-04	3.31E-04
Ps99%/90% (-KTL) Biased	-2.85E-04	-2.82E-04	-2.75E-04	-2.62E-04	-2.32E-04	-2.30E-04	-2.38E-04
<b>Un-Biased Statistics</b>							
Average Un-Biased	3.64E-06	1.11E-05	1.97E-05	2.55E-05	4.01E-05	4.05E-05	2.39E-05
Std Dev Un-Biased	2.40E-05	2.36E-05	2.16E-05	2.01E-05	1.83E-05	1.91E-05	2.56E-05
Ps99%/90% (+KTL) Un-Biased	1.16E-04	1.21E-04	1.21E-04	1.19E-04	1.25E-04	1.30E-04	1.43E-04
Ps99%/90% (-KTL) Un-Biased	-1.09E-04	-9.92E-05	-8.11E-05	-6.84E-05	-4.52E-05	-4.85E-05	-9.56E-05
<b>Specification MIN</b>	<b>-3.00E-04</b>	<b>-4.50E-04</b>	<b>-4.50E-04</b>	<b>-4.50E-04</b>	<b>-6.00E-04</b>	<b>-6.00E-04</b>	<b>-6.00E-04</b>
Status	PASS	PASS	PASS	PASS	PASS	PASS	PASS
<b>Specification MAX</b>	<b>3.00E-04</b>	<b>4.50E-04</b>	<b>4.50E-04</b>	<b>4.50E-04</b>	<b>6.00E-04</b>	<b>6.00E-04</b>	<b>6.00E-04</b>
Status	FAIL	PASS	PASS	PASS	PASS	PASS	PASS

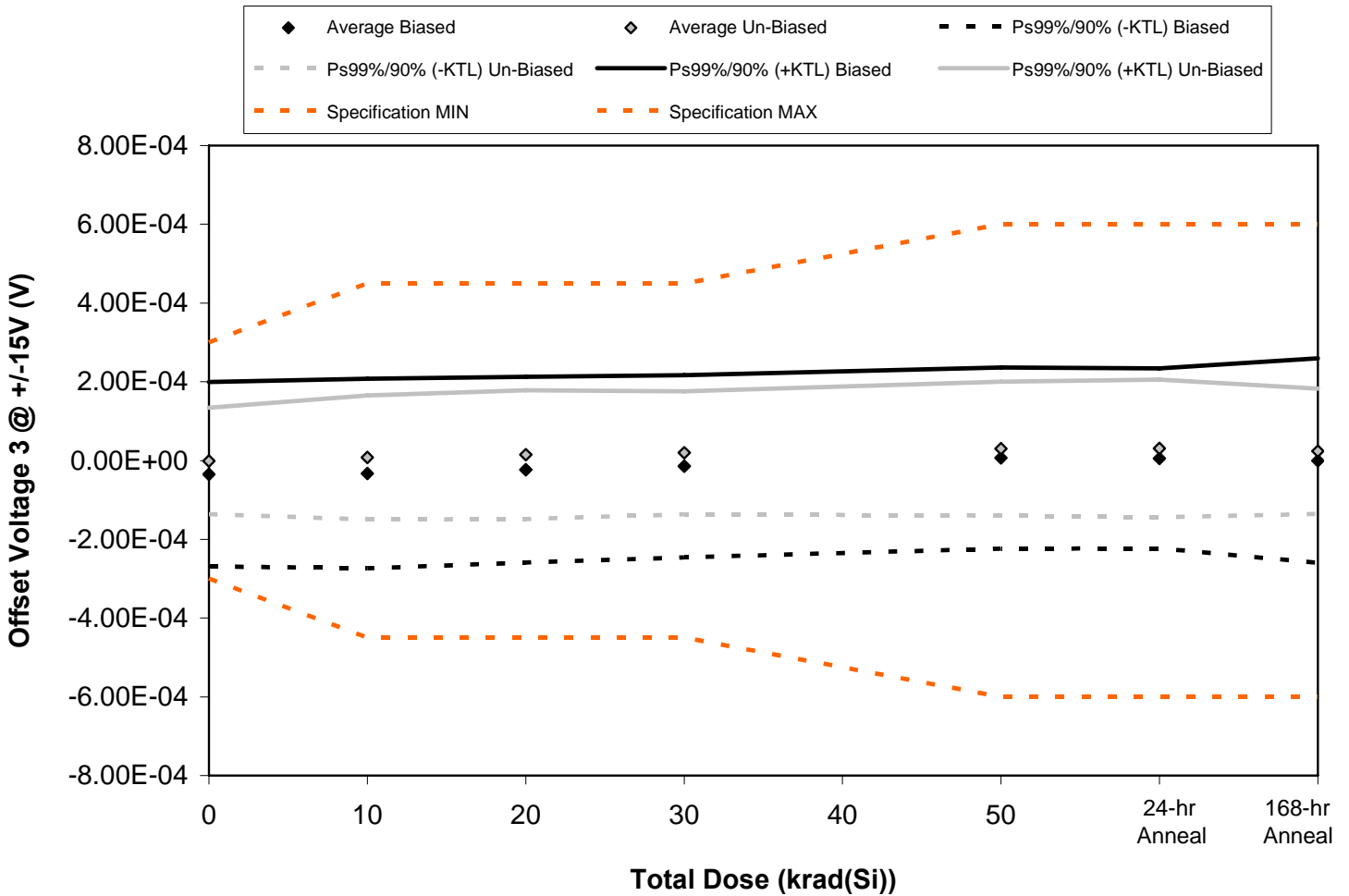

Figure 5.5. Plot of Offset Voltage 3 @ +/-15V (V) versus total dose. The data show no significant degradation with radiation. The solid diamonds are the average of measured data points from the biased sample (devices irradiated with an electrical bias) while the shaded diamonds are the average from the unbiased sample. The black lines show the effects on the data after application of the biased KTL statistics (solid and dashed lines) while the gray lines show the effects on the data after application of the unbiased KTL statistics (solid and dashed lines). The red dashed lines are the minimum and maximum specification values as defined in the datasheet and/or test plan.





Table 5.5. Raw data for Offset Voltage 3 @ +/-15V (V) versus total dose, including the statistical analysis, the specification and the status of the testing (pass/fail).

Offset Voltage 3 @ +/-15V (V)	Total Dose (krad(Si))					24-hr Anneal	168-hr Anneal
	0	10	20	30	50		
Device							
1027	-4.60E-05	-4.40E-05	-3.14E-05	-2.71E-05	-7.85E-06	-1.22E-05	-2.23E-05
1029	-7.98E-05	-7.50E-05	-6.33E-05	-5.11E-05	-3.32E-05	-3.33E-05	-4.44E-05
1030	1.14E-05	1.22E-05	1.63E-05	1.99E-05	4.55E-05	4.53E-05	3.93E-05
1031	-8.33E-05	-8.67E-05	-7.77E-05	-6.59E-05	-4.27E-05	-4.18E-05	-4.99E-05
1032	2.39E-05	2.89E-05	4.03E-05	5.26E-05	6.96E-05	6.84E-05	7.68E-05
1033	-2.20E-05	-2.14E-05	-1.75E-05	-1.05E-05	-3.14E-06	-2.30E-06	-1.09E-05
1034	-2.30E-05	-1.81E-05	-1.28E-05	-1.03E-05	-3.75E-06	-6.16E-06	-6.89E-06
1035	3.44E-05	4.79E-05	5.56E-05	5.43E-05	6.40E-05	6.54E-05	6.29E-05
1036	-2.19E-05	-1.00E-05	2.30E-07	8.33E-06	2.06E-05	2.22E-05	1.88E-05
1038	2.66E-05	4.11E-05	4.98E-05	5.64E-05	7.29E-05	7.41E-05	5.49E-05
1039	-4.35E-05	-4.26E-05	-4.64E-05	-4.40E-05	-4.00E-05	-4.47E-05	-3.85E-05
<b>Biased Statistics</b>							
Average Biased	-3.48E-05	-3.29E-05	-2.32E-05	-1.43E-05	6.27E-06	5.28E-06	-1.06E-07
Std Dev Biased	5.02E-05	5.16E-05	5.06E-05	4.96E-05	4.93E-05	4.90E-05	5.57E-05
Ps99%/90% (+KTL) Biased	2.00E-04	2.08E-04	2.13E-04	2.17E-04	2.36E-04	2.34E-04	2.60E-04
Ps99%/90% (-KTL) Biased	-2.69E-04	-2.74E-04	-2.59E-04	-2.46E-04	-2.24E-04	-2.23E-04	-2.60E-04
<b>Un-Biased Statistics</b>							
Average Un-Biased	-1.16E-06	7.89E-06	1.51E-05	1.97E-05	3.01E-05	3.07E-05	2.38E-05
Std Dev Un-Biased	2.90E-05	3.38E-05	3.50E-05	3.35E-05	3.65E-05	3.74E-05	3.41E-05
Ps99%/90% (+KTL) Un-Biased	1.34E-04	1.65E-04	1.79E-04	1.76E-04	2.00E-04	2.05E-04	1.83E-04
Ps99%/90% (-KTL) Un-Biased	-1.37E-04	-1.50E-04	-1.48E-04	-1.37E-04	-1.40E-04	-1.44E-04	-1.36E-04
<b>Specification MIN</b>	<b>-3.00E-04</b>	<b>-4.50E-04</b>	<b>-4.50E-04</b>	<b>-4.50E-04</b>	<b>-6.00E-04</b>	<b>-6.00E-04</b>	<b>-6.00E-04</b>
Status	PASS	PASS	PASS	PASS	PASS	PASS	PASS
<b>Specification MAX</b>	<b>3.00E-04</b>	<b>4.50E-04</b>	<b>4.50E-04</b>	<b>4.50E-04</b>	<b>6.00E-04</b>	<b>6.00E-04</b>	<b>6.00E-04</b>
Status	PASS	PASS	PASS	PASS	PASS	PASS	PASS

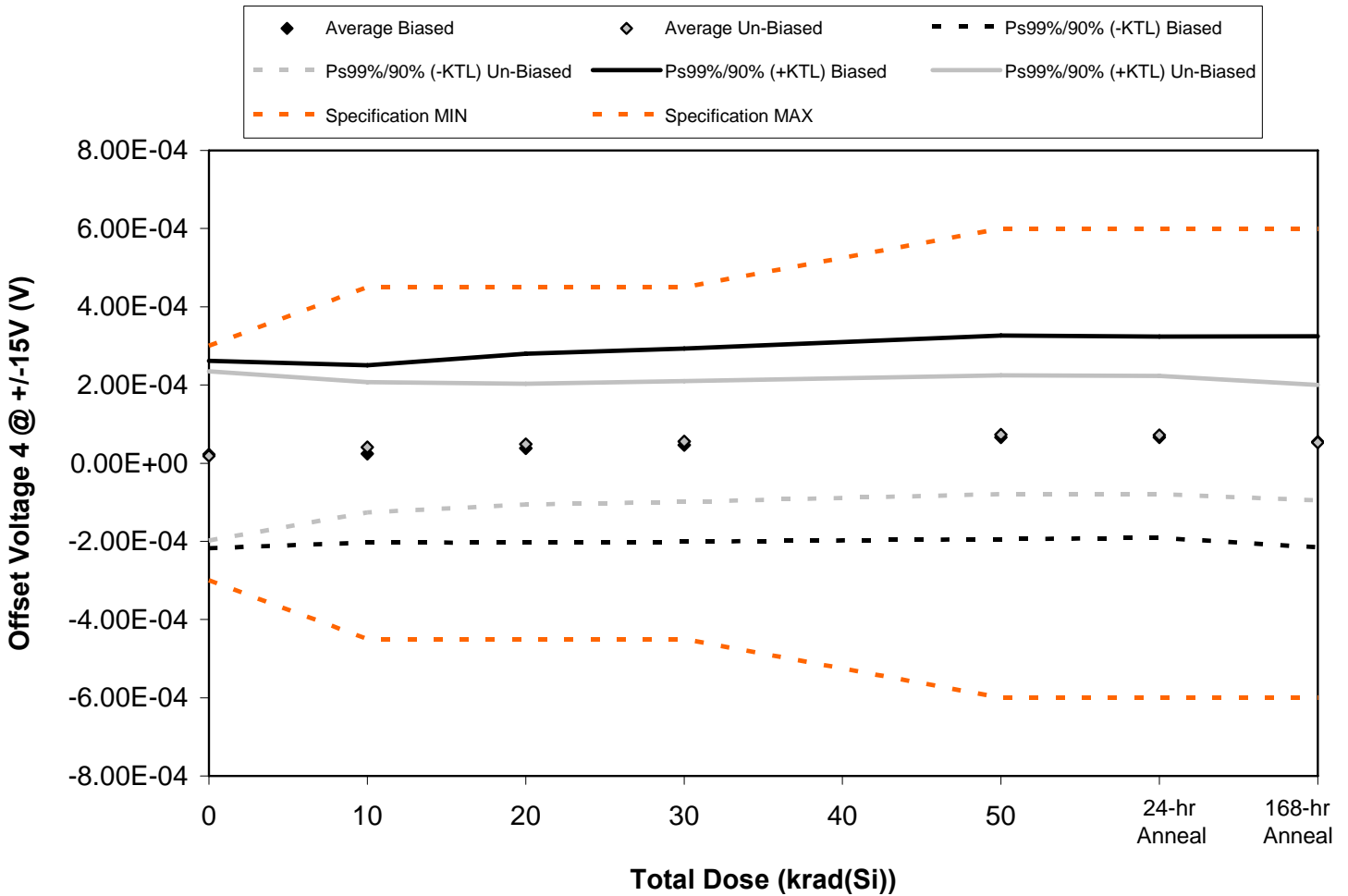

Figure 5.6. Plot of Offset Voltage 4 @ +/-15V (V) versus total dose. The data show no significant degradation with radiation. The solid diamonds are the average of measured data points from the biased sample (devices irradiated with an electrical bias) while the shaded diamonds are the average from the unbiased sample. The black lines show the effects on the data after application of the biased KTL statistics (solid and dashed lines) while the gray lines show the effects on the data after application of the unbiased KTL statistics (solid and dashed lines). The red dashed lines are the minimum and maximum specification values as defined in the datasheet and/or test plan.



Table 5.6. Raw data for Offset Voltage 4 @ +/-15V (V) versus total dose, including the statistical analysis, the specification and the status of the testing (pass/fail).

Offset Voltage 4 @ +/-15V (V)	Total Dose (krad(Si))					24-hr Anneal	168-hr Anneal
	0	10	20	30	50		
Device							
1027	-6.77E-06	-7.49E-06	2.89E-06	1.07E-05	1.77E-05	2.32E-05	5.79E-06
1029	6.93E-05	8.01E-05	9.87E-05	1.06E-04	1.31E-04	1.29E-04	1.26E-04
1030	-4.58E-05	-3.74E-05	-2.56E-05	-1.98E-05	5.19E-06	2.65E-06	-1.29E-05
1031	1.78E-05	2.09E-05	3.38E-05	4.30E-05	6.29E-05	6.20E-05	6.35E-05
1032	7.55E-05	6.28E-05	8.00E-05	9.09E-05	1.14E-04	1.15E-04	9.02E-05
1033	1.80E-05	2.83E-05	3.45E-05	4.10E-05	6.31E-05	6.11E-05	3.02E-05
1034	5.19E-05	5.87E-05	6.17E-05	6.74E-05	7.66E-05	7.81E-05	6.69E-05
1035	5.91E-05	6.76E-05	7.14E-05	8.08E-05	9.76E-05	9.48E-05	7.14E-05
1036	2.25E-05	6.55E-05	7.77E-05	8.43E-05	1.04E-04	1.04E-04	8.48E-05
1038	-5.79E-05	-1.66E-05	-2.91E-06	4.83E-06	2.23E-05	2.18E-05	9.04E-06
1039	-9.06E-06	-1.16E-05	-7.85E-06	-8.94E-06	-1.22E-05	-9.06E-06	-1.18E-05
<b>Biased Statistics</b>							
Average Biased	2.20E-05	2.38E-05	3.80E-05	4.62E-05	6.60E-05	6.63E-05	5.45E-05
Std Dev Biased	5.13E-05	4.85E-05	5.18E-05	5.29E-05	5.59E-05	5.52E-05	5.78E-05
Ps99%/90% (+KTL) Biased	2.61E-04	2.50E-04	2.80E-04	2.93E-04	3.27E-04	3.24E-04	3.24E-04
Ps99%/90% (-KTL) Biased	-2.17E-04	-2.03E-04	-2.04E-04	-2.01E-04	-1.95E-04	-1.91E-04	-2.15E-04
<b>Un-Biased Statistics</b>							
Average Un-Biased	1.87E-05	4.07E-05	4.85E-05	5.57E-05	7.27E-05	7.19E-05	5.25E-05
Std Dev Un-Biased	4.64E-05	3.57E-05	3.31E-05	3.31E-05	3.25E-05	3.24E-05	3.16E-05
Ps99%/90% (+KTL) Un-Biased	2.35E-04	2.07E-04	2.03E-04	2.10E-04	2.24E-04	2.23E-04	2.00E-04
Ps99%/90% (-KTL) Un-Biased	-1.98E-04	-1.26E-04	-1.06E-04	-9.88E-05	-7.90E-05	-7.92E-05	-9.50E-05
<b>Specification MIN</b>	<b>-3.00E-04</b>	<b>-4.50E-04</b>	<b>-4.50E-04</b>	<b>-4.50E-04</b>	<b>-6.00E-04</b>	<b>-6.00E-04</b>	<b>-6.00E-04</b>
Status	PASS	PASS	PASS	PASS	PASS	PASS	PASS
<b>Specification MAX</b>	<b>3.00E-04</b>	<b>4.50E-04</b>	<b>4.50E-04</b>	<b>4.50E-04</b>	<b>6.00E-04</b>	<b>6.00E-04</b>	<b>6.00E-04</b>
Status	PASS	PASS	PASS	PASS	PASS	PASS	PASS

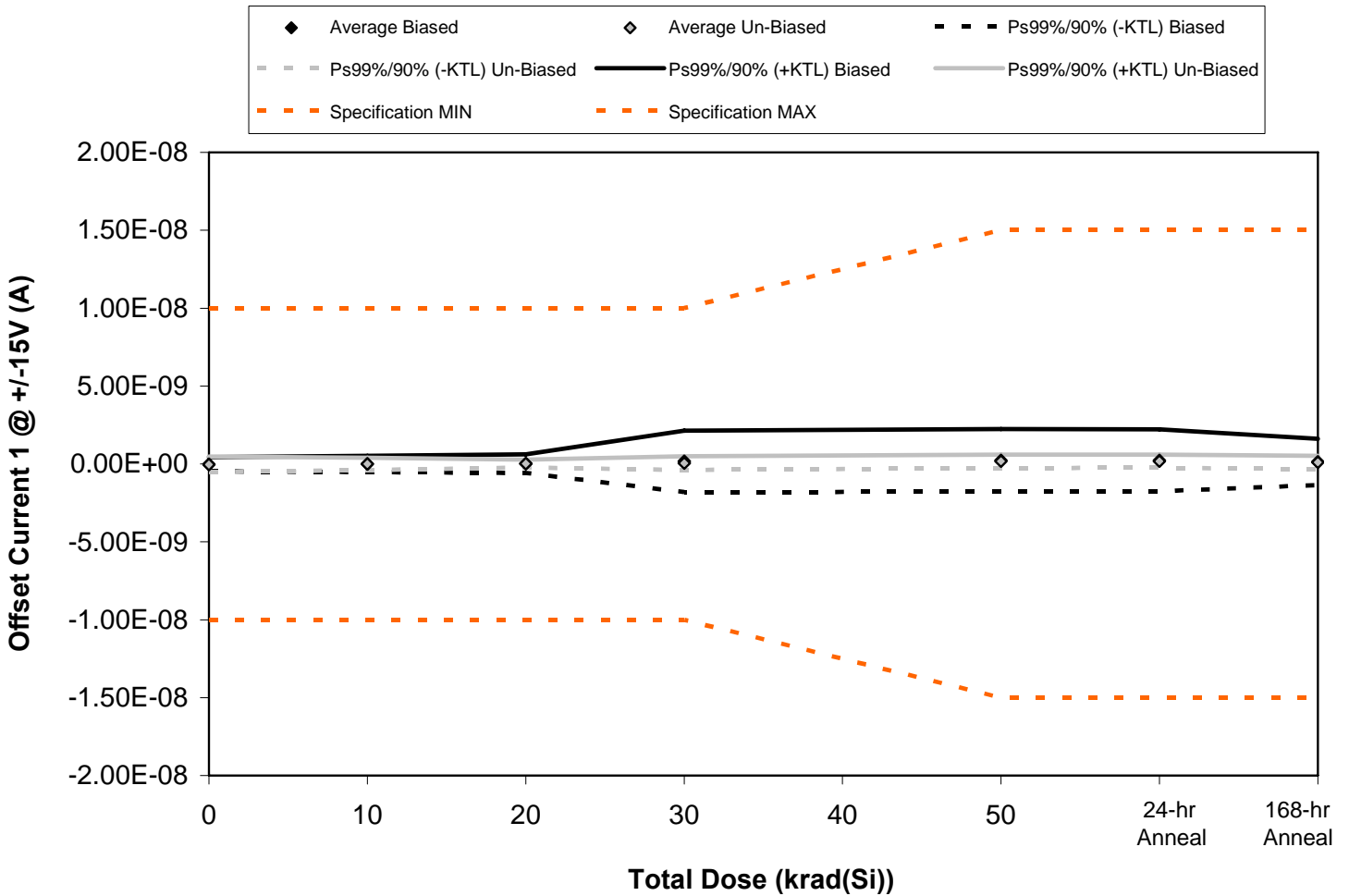

Figure 5.7. Plot of Offset Current 1 @ +/-15V (A) versus total dose. The data show no significant degradation with radiation. The solid diamonds are the average of measured data points from the biased sample (devices irradiated with an electrical bias) while the shaded diamonds are the average from the unbiased sample. The black lines show the effects on the data after application of the biased KTL statistics (solid and dashed lines) while the gray lines show the effects on the data after application of the unbiased KTL statistics (solid and dashed lines). The red dashed lines are the minimum and maximum specification values as defined in the datasheet and/or test plan.



Table 5.7. Raw data for Offset Current 1 @ +/-15V (A) versus total dose, including the statistical analysis, the specification and the status of the testing (pass/fail).

Offset Current 1 @ +/-15V (A)	Total Dose (krad(Si))					24-hr Anneal	168-hr Anneal
	0	10	20	30	50		
Device							
1027	1.13E-10	1.75E-10	1.52E-10	1.00E-10	1.42E-10	2.10E-10	-4.10E-11
1029	5.00E-12	2.50E-11	-4.90E-11	-4.10E-11	-5.30E-11	-5.80E-11	7.30E-11
1030	-9.40E-11	-6.10E-11	1.36E-10	9.11E-10	9.82E-10	9.79E-10	6.97E-10
1031	-1.34E-10	-1.22E-10	-1.51E-10	-1.18E-10	-3.60E-11	-7.00E-12	-3.30E-11
1032	8.00E-12	-3.80E-11	3.00E-11	-9.00E-12	8.80E-11	5.40E-11	-1.40E-11
1033	-7.50E-11	-4.10E-11	2.40E-11	-8.00E-12	7.60E-11	7.50E-11	1.66E-10
1034	-1.18E-10	-7.20E-11	1.40E-11	2.90E-11	1.61E-10	1.74E-10	-3.90E-11
1035	1.43E-10	1.33E-10	8.50E-11	2.02E-10	3.16E-10	2.98E-10	1.76E-10
1036	-1.06E-10	-4.00E-11	-6.00E-11	-4.20E-11	1.08E-10	9.30E-11	4.50E-11
1038	-6.00E-12	5.40E-11	5.00E-11	5.60E-11	1.79E-10	2.05E-10	1.45E-10
1039	-1.80E-11	-1.80E-11	-1.30E-11	-2.00E-12	-1.90E-11	-3.20E-11	-3.50E-11
<b>Biased Statistics</b>							
Average Biased	-2.04E-11	-4.20E-12	2.36E-11	1.69E-10	2.25E-10	2.36E-10	1.36E-10
Std Dev Biased	9.69E-11	1.13E-10	1.27E-10	4.22E-10	4.31E-10	4.28E-10	3.17E-10
Ps99%/90% (+KTL) Biased	4.32E-10	5.24E-10	6.18E-10	2.14E-09	2.24E-09	2.23E-09	1.61E-09
Ps99%/90% (-KTL) Biased	-4.73E-10	-5.32E-10	-5.71E-10	-1.80E-09	-1.79E-09	-1.76E-09	-1.34E-09
<b>Un-Biased Statistics</b>							
Average Un-Biased	-3.24E-11	6.80E-12	2.26E-11	4.74E-11	1.68E-10	1.69E-10	9.86E-11
Std Dev Un-Biased	1.07E-10	8.49E-11	5.37E-11	9.40E-11	9.24E-11	9.02E-11	9.29E-11
Ps99%/90% (+KTL) Un-Biased	4.68E-10	4.03E-10	2.73E-10	4.86E-10	5.99E-10	5.90E-10	5.32E-10
Ps99%/90% (-KTL) Un-Biased	-5.33E-10	-3.89E-10	-2.28E-10	-3.91E-10	-2.63E-10	-2.52E-10	-3.35E-10
<b>Specification MIN</b>	<b>-1.00E-08</b>	<b>-1.00E-08</b>	<b>-1.00E-08</b>	<b>-1.00E-08</b>	<b>-1.50E-08</b>	<b>-1.50E-08</b>	<b>-1.50E-08</b>
Status	PASS	PASS	PASS	PASS	PASS	PASS	PASS
<b>Specification MAX</b>	<b>1.00E-08</b>	<b>1.00E-08</b>	<b>1.00E-08</b>	<b>1.00E-08</b>	<b>1.50E-08</b>	<b>1.50E-08</b>	<b>1.50E-08</b>
Status	PASS	PASS	PASS	PASS	PASS	PASS	PASS

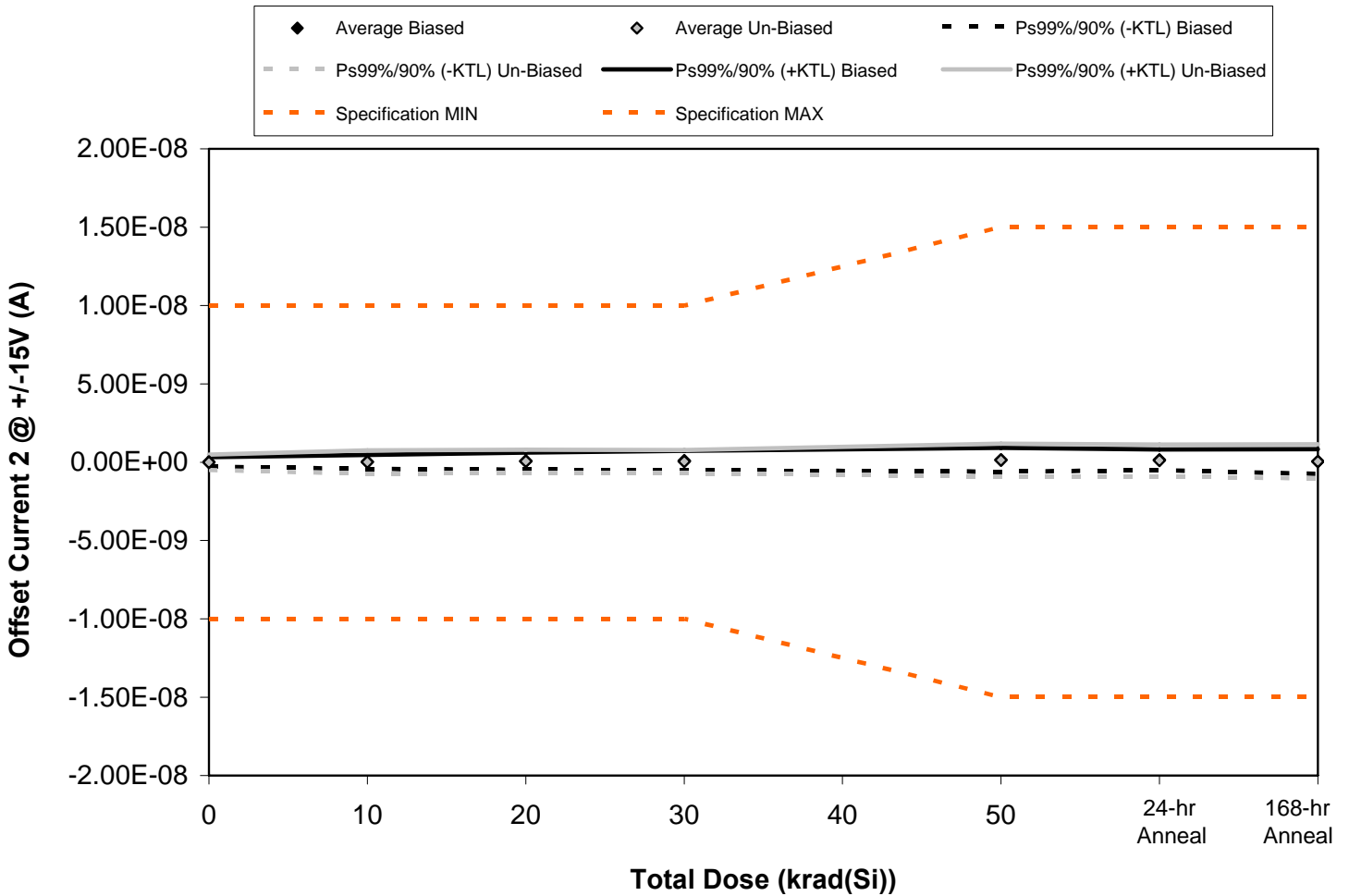

Figure 5.8. Plot of Offset Current 2 @ +/-15V (A) versus total dose. The data show no significant degradation with radiation. The solid diamonds are the average of measured data points from the biased sample (devices irradiated with an electrical bias) while the shaded diamonds are the average from the unbiased sample. The black lines show the effects on the data after application of the biased KTL statistics (solid and dashed lines) while the gray lines show the effects on the data after application of the unbiased KTL statistics (solid and dashed lines). The red dashed lines are the minimum and maximum specification values as defined in the datasheet and/or test plan.



Table 5.8. Raw data for Offset Current 2 @ +/-15V (A) versus total dose, including the statistical analysis, the specification and the status of the testing (pass/fail).

Offset Current 2 @ +/-15V (A)	Total Dose (krad(Si))					24-hr Anneal	168-hr Anneal
	0	10	20	30	50		
Device							
1027	-2.10E-11	-7.10E-11	5.00E-11	3.00E-11	-6.00E-12	4.40E-11	-3.30E-11
1029	-7.80E-11	-9.90E-11	-9.10E-11	-4.50E-11	6.90E-11	5.50E-11	-1.47E-10
1030	2.80E-11	8.00E-11	2.30E-11	6.50E-11	4.90E-11	4.60E-11	-5.60E-11
1031	3.90E-11	1.00E-10	1.80E-10	1.68E-10	3.26E-10	2.82E-10	2.33E-10
1032	9.60E-11	8.50E-11	1.93E-10	2.94E-10	3.38E-10	3.32E-10	2.05E-10
1033	8.10E-11	1.53E-10	1.67E-10	1.94E-10	2.23E-10	2.24E-10	1.46E-10
1034	-1.51E-10	-2.50E-10	-2.07E-10	-2.11E-10	-2.24E-10	-2.19E-10	-3.36E-10
1035	1.12E-10	1.32E-10	1.80E-10	1.37E-10	3.85E-10	3.70E-10	2.70E-10
1036	-4.00E-11	1.50E-11	9.60E-11	8.40E-11	1.46E-10	1.07E-10	1.47E-10
1038	-2.50E-11	5.00E-12	5.30E-11	-2.90E-11	8.90E-11	5.80E-11	8.00E-12
1039	5.90E-11	2.90E-11	4.50E-11	3.50E-11	7.00E-12	2.30E-11	2.90E-11
<b>Biased Statistics</b>							
Average Biased	1.28E-11	1.90E-11	7.10E-11	1.02E-10	1.55E-10	1.52E-10	4.04E-11
Std Dev Biased	6.56E-11	9.57E-11	1.18E-10	1.32E-10	1.64E-10	1.43E-10	1.69E-10
Ps99%/90% (+KTL) Biased	3.19E-10	4.66E-10	6.22E-10	7.17E-10	9.19E-10	8.18E-10	8.28E-10
Ps99%/90% (-KTL) Biased	-2.93E-10	-4.28E-10	-4.80E-10	-5.12E-10	-6.09E-10	-5.15E-10	-7.47E-10
<b>Un-Biased Statistics</b>							
Average Un-Biased	-4.60E-12	1.10E-11	5.78E-11	3.50E-11	1.24E-10	1.08E-10	4.70E-11
Std Dev Un-Biased	1.05E-10	1.60E-10	1.57E-10	1.60E-10	2.24E-10	2.19E-10	2.33E-10
Ps99%/90% (+KTL) Un-Biased	4.85E-10	7.60E-10	7.90E-10	7.83E-10	1.17E-09	1.13E-09	1.14E-09
Ps99%/90% (-KTL) Un-Biased	-4.94E-10	-7.38E-10	-6.74E-10	-7.13E-10	-9.21E-10	-9.13E-10	-1.04E-09
<b>Specification MIN</b>	<b>-1.00E-08</b>	<b>-1.00E-08</b>	<b>-1.00E-08</b>	<b>-1.00E-08</b>	<b>-1.50E-08</b>	<b>-1.50E-08</b>	<b>-1.50E-08</b>
Status	PASS	PASS	PASS	PASS	PASS	PASS	PASS
<b>Specification MAX</b>	<b>1.00E-08</b>	<b>1.00E-08</b>	<b>1.00E-08</b>	<b>1.00E-08</b>	<b>1.50E-08</b>	<b>1.50E-08</b>	<b>1.50E-08</b>
Status	PASS	PASS	PASS	PASS	PASS	PASS	PASS

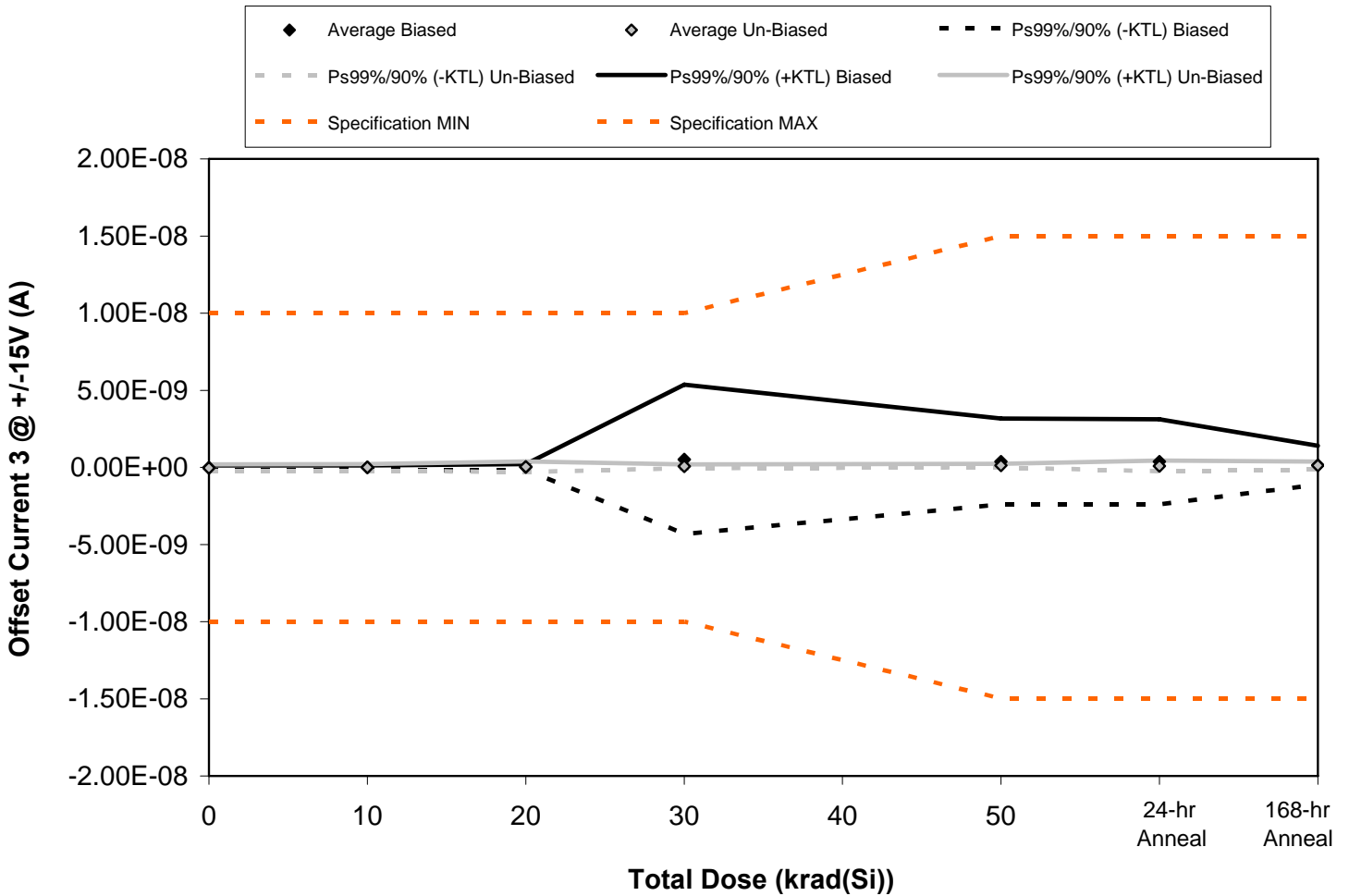

Figure 5.9. Plot of Offset Current 3 @ +/-15V (A) versus total dose. The data show no significant degradation with radiation. The solid diamonds are the average of measured data points from the biased sample (devices irradiated with an electrical bias) while the shaded diamonds are the average from the unbiased sample. The black lines show the effects on the data after application of the biased KTL statistics (solid and dashed lines) while the gray lines show the effects on the data after application of the unbiased KTL statistics (solid and dashed lines). The red dashed lines are the minimum and maximum specification values as defined in the datasheet and/or test plan.





Table 5.9. Raw data for Offset Current 3 @ +/-15V (A) versus total dose, including the statistical analysis, the specification and the status of the testing (pass/fail).

Offset Current 3 @ +/-15V (A)	Total Dose (krad(Si))					24-hr Anneal	168-hr Anneal
	0	10	20	30	50		
Device							
1027	-1.50E-11	-2.70E-11	7.00E-12	-5.20E-11	2.60E-11	-3.00E-11	-3.10E-11
1029	3.00E-11	3.50E-11	9.00E-12	7.40E-11	1.22E-10	1.32E-10	-5.00E-12
1030	-3.00E-11	-3.50E-11	-5.30E-11	2.37E-09	1.44E-09	1.41E-09	6.12E-10
1031	-4.40E-11	-3.00E-12	5.00E-11	1.35E-10	1.12E-10	9.30E-11	1.03E-10
1032	-5.30E-11	-1.40E-11	4.70E-11	6.70E-11	1.73E-10	2.22E-10	3.10E-11
1033	3.60E-11	6.40E-11	1.07E-10	8.90E-11	1.28E-10	1.31E-10	1.76E-10
1034	-4.00E-11	-2.10E-11	4.60E-11	5.10E-11	8.20E-11	-3.40E-11	9.40E-11
1035	1.00E-12	8.00E-12	6.30E-11	6.30E-11	1.06E-10	1.36E-10	5.70E-11
1036	-4.90E-11	6.00E-12	8.50E-11	1.10E-10	1.47E-10	1.44E-10	1.78E-10
1038	-9.10E-11	-5.70E-11	-8.10E-11	4.20E-11	1.28E-10	9.90E-11	8.00E-11
1039	3.00E-11	4.30E-11	-3.10E-11	-1.00E-11	-1.00E-12	2.20E-11	3.00E-11
<b>Biased Statistics</b>							
Average Biased	-2.24E-11	-8.80E-12	1.20E-11	5.19E-10	3.75E-10	3.65E-10	1.42E-10
Std Dev Biased	3.26E-11	2.74E-11	4.16E-11	1.04E-09	5.98E-10	5.90E-10	2.68E-10
Ps99%/90% (+KTL) Biased	1.30E-10	1.19E-10	2.06E-10	5.36E-09	3.16E-09	3.12E-09	1.39E-09
Ps99%/90% (-KTL) Biased	-1.75E-10	-1.37E-10	-1.82E-10	-4.33E-09	-2.42E-09	-2.39E-09	-1.11E-09
<b>Un-Biased Statistics</b>							
Average Un-Biased	-2.86E-11	0.00E+00	4.40E-11	7.10E-11	1.18E-10	9.52E-11	1.17E-10
Std Dev Un-Biased	4.87E-11	4.44E-11	7.36E-11	2.81E-11	2.49E-11	7.42E-11	5.63E-11
Ps99%/90% (+KTL) Un-Biased	1.99E-10	2.07E-10	3.87E-10	2.02E-10	2.34E-10	4.42E-10	3.80E-10
Ps99%/90% (-KTL) Un-Biased	-2.56E-10	-2.07E-10	-2.99E-10	-5.99E-11	2.00E-12	-2.51E-10	-1.46E-10
<b>Specification MIN</b>	<b>-1.00E-08</b>	<b>-1.00E-08</b>	<b>-1.00E-08</b>	<b>-1.00E-08</b>	<b>-1.50E-08</b>	<b>-1.50E-08</b>	<b>-1.50E-08</b>
Status	PASS	PASS	PASS	PASS	PASS	PASS	PASS
<b>Specification MAX</b>	<b>1.00E-08</b>	<b>1.00E-08</b>	<b>1.00E-08</b>	<b>1.00E-08</b>	<b>1.50E-08</b>	<b>1.50E-08</b>	<b>1.50E-08</b>
Status	PASS	PASS	PASS	PASS	PASS	PASS	PASS

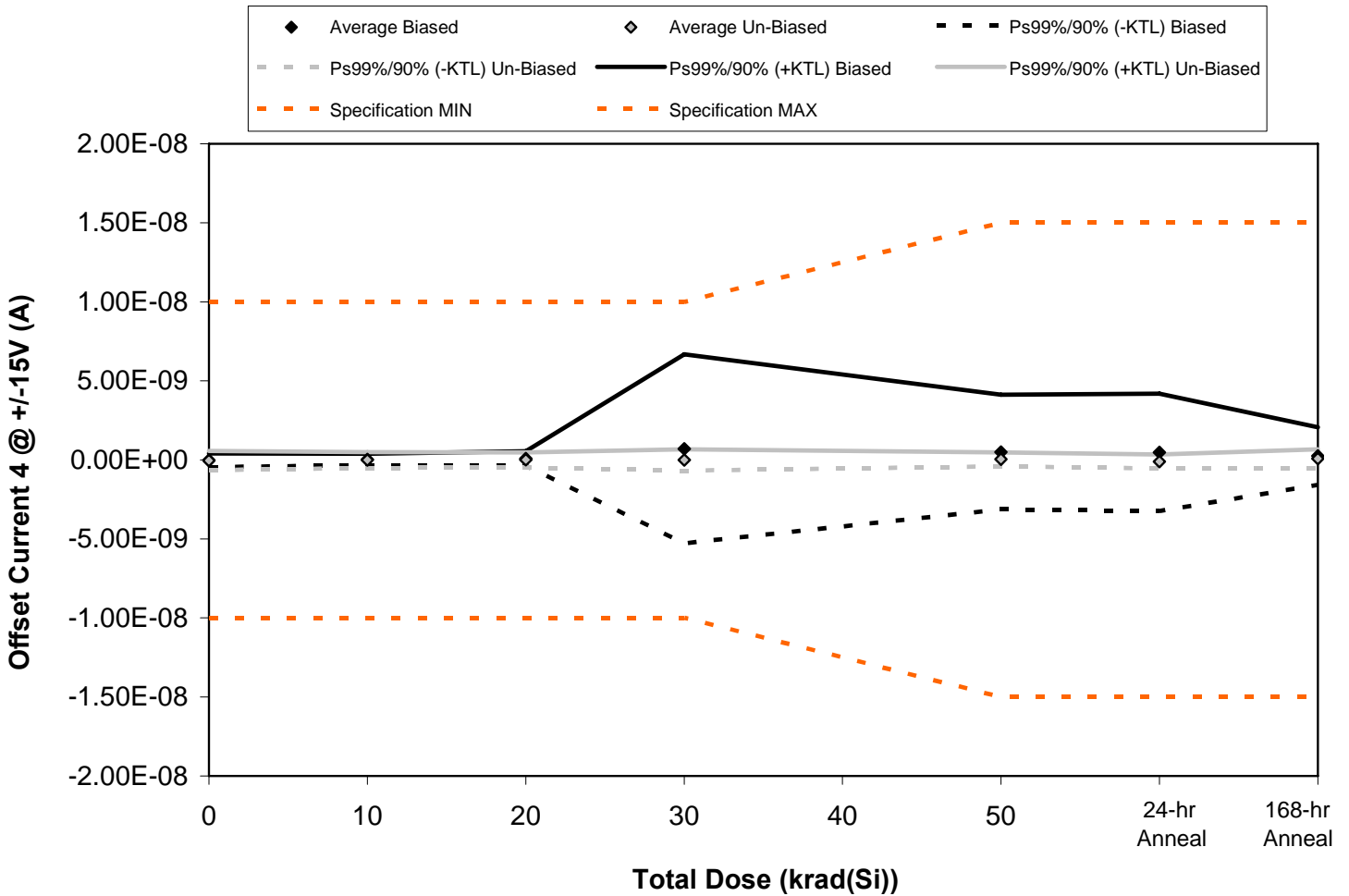

Figure 5.10. Plot of Offset Current 4 @ +/-15V (A) versus total dose. The data show no significant degradation with radiation. The solid diamonds are the average of measured data points from the biased sample (devices irradiated with an electrical bias) while the shaded diamonds are the average from the unbiased sample. The black lines show the effects on the data after application of the biased KTL statistics (solid and dashed lines) while the gray lines show the effects on the data after application of the unbiased KTL statistics (solid and dashed lines). The red dashed lines are the minimum and maximum specification values as defined in the datasheet and/or test plan.



Table 5.10. Raw data for Offset Current 4 @ +/-15V (A) versus total dose, including the statistical analysis, the specification and the status of the testing (pass/fail).

Offset Current 4 @ +/-15V (A)	Total Dose (krad(Si))					24-hr Anneal	168-hr Anneal
	0	10	20	30	50		
Device							
1027	1.25E-10	1.41E-10	1.94E-10	1.84E-10	2.43E-10	1.86E-10	1.10E-10
1029	-4.90E-11	-4.10E-11	-1.50E-11	1.94E-10	1.76E-10	1.62E-10	2.26E-10
1030	-4.00E-12	3.40E-11	9.30E-11	2.99E-09	1.87E-09	1.88E-09	8.67E-10
1031	-5.90E-11	6.60E-11	1.70E-10	2.22E-10	2.42E-10	2.35E-10	2.18E-10
1032	-1.23E-10	-4.20E-11	-1.50E-11	-6.60E-11	-7.00E-11	-9.10E-11	-2.08E-10
1033	-1.10E-11	6.30E-11	0.00E+00	-5.60E-11	-1.50E-11	-1.53E-10	1.05E-10
1034	1.20E-11	1.06E-10	6.90E-11	1.12E-10	6.60E-11	-5.00E-11	1.56E-10
1035	9.80E-11	2.30E-11	1.18E-10	1.73E-10	1.87E-10	-5.00E-12	2.06E-10
1036	-2.51E-10	-1.73E-10	-1.50E-10	-1.85E-10	-6.10E-11	-2.48E-10	-1.08E-10
1038	-6.50E-11	-2.30E-11	-3.50E-11	-5.90E-11	1.00E-11	-7.70E-11	-6.00E-12
1039	-5.50E-11	-5.80E-11	-9.50E-11	-7.80E-11	-2.60E-11	-4.20E-11	-8.80E-11
<b>Biased Statistics</b>							
Average Biased	-2.20E-11	3.16E-11	8.54E-11	7.04E-10	4.91E-10	4.75E-10	2.43E-10
Std Dev Biased	9.25E-11	7.72E-11	9.90E-11	1.28E-09	7.79E-10	7.97E-10	3.91E-10
Ps99%/90% (+KTL) Biased	4.10E-10	3.92E-10	5.47E-10	6.69E-09	4.12E-09	4.19E-09	2.07E-09
Ps99%/90% (-KTL) Biased	-4.54E-10	-3.29E-10	-3.76E-10	-5.28E-09	-3.14E-09	-3.24E-09	-1.58E-09
<b>Un-Biased Statistics</b>							
Average Un-Biased	-4.34E-11	-8.00E-13	4.00E-13	-3.00E-12	3.74E-11	-1.07E-10	7.06E-11
Std Dev Un-Biased	1.30E-10	1.07E-10	1.03E-10	1.44E-10	9.54E-11	9.56E-11	1.27E-10
Ps99%/90% (+KTL) Un-Biased	5.64E-10	5.01E-10	4.81E-10	6.70E-10	4.82E-10	3.39E-10	6.63E-10
Ps99%/90% (-KTL) Un-Biased	-6.50E-10	-5.02E-10	-4.80E-10	-6.76E-10	-4.08E-10	-5.53E-10	-5.22E-10
<b>Specification MIN</b>	<b>-1.00E-08</b>	<b>-1.00E-08</b>	<b>-1.00E-08</b>	<b>-1.00E-08</b>	<b>-1.50E-08</b>	<b>-1.50E-08</b>	<b>-1.50E-08</b>
Status	PASS	PASS	PASS	PASS	PASS	PASS	PASS
<b>Specification MAX</b>	<b>1.00E-08</b>	<b>1.00E-08</b>	<b>1.00E-08</b>	<b>1.00E-08</b>	<b>1.50E-08</b>	<b>1.50E-08</b>	<b>1.50E-08</b>
Status	PASS	PASS	PASS	PASS	PASS	PASS	PASS

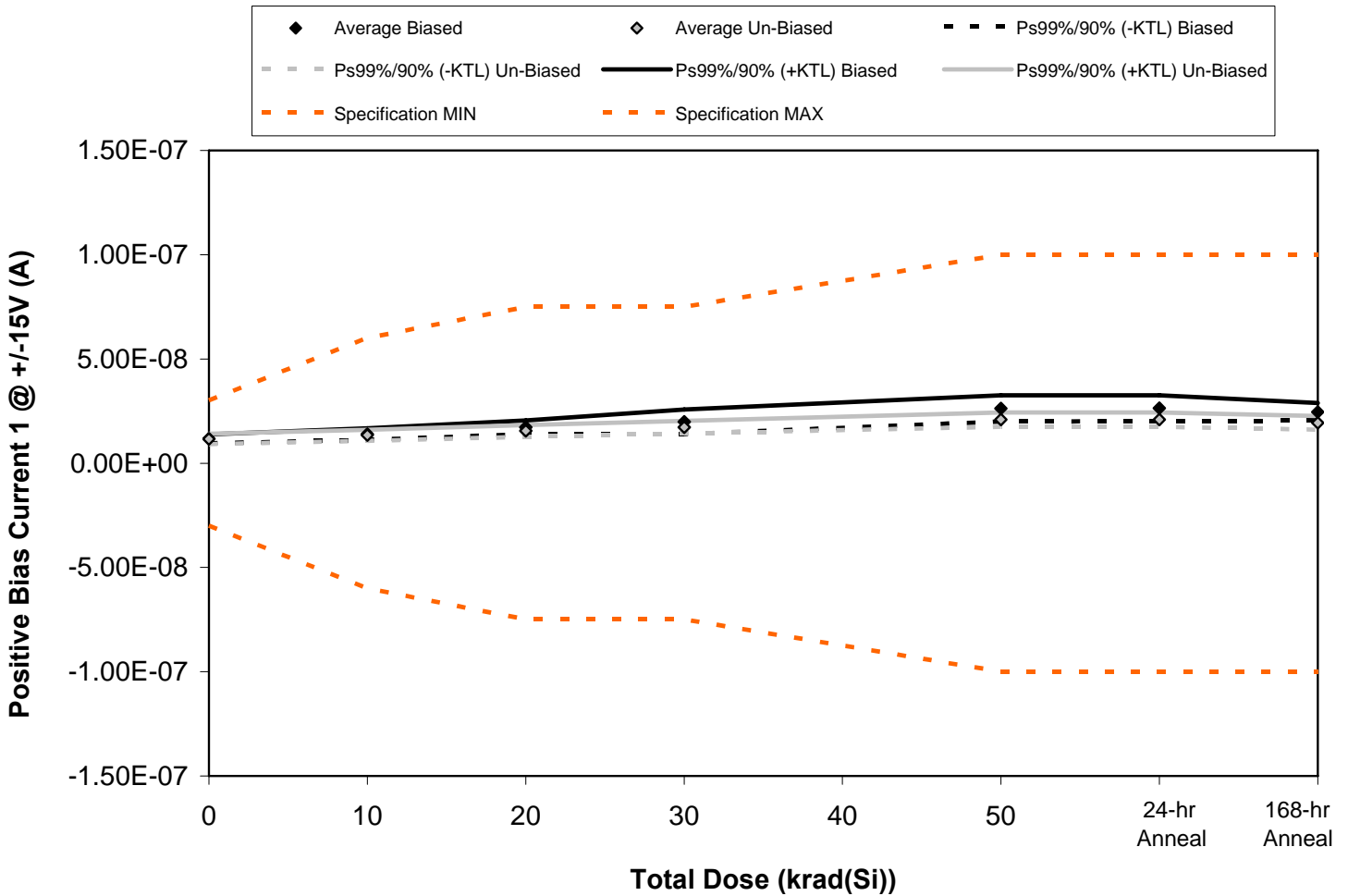

Figure 5.11. Plot of Positive Bias Current 1 @ +/-15V (A) versus total dose. The data show no significant degradation with radiation. The solid diamonds are the average of measured data points from the biased sample (devices irradiated with an electrical bias) while the shaded diamonds are the average from the unbiased sample. The black lines show the effects on the data after application of the biased KTL statistics (solid and dashed lines) while the gray lines show the effects on the data after application of the unbiased KTL statistics (solid and dashed lines). The red dashed lines are the minimum and maximum specification values as defined in the datasheet and/or test plan.



Table 5.11. Raw data for Positive Bias Current 1 @ +/-15V (A) versus total dose, including the statistical analysis, the specification and the status of the testing (pass/fail).

Positive Bias Current 1 @ +/-15V (A)	Total Dose (krad(Si))					24-hr Anneal	168-hr Anneal
	0	10	20	30	50		
Device							
1027	1.21E-08	1.46E-08	1.81E-08	2.12E-08	2.80E-08	2.80E-08	2.55E-08
1029	1.09E-08	1.30E-08	1.62E-08	1.90E-08	2.52E-08	2.53E-08	2.33E-08
1030	1.17E-08	1.38E-08	1.70E-08	1.81E-08	2.46E-08	2.47E-08	2.41E-08
1031	1.17E-08	1.41E-08	1.73E-08	2.03E-08	2.66E-08	2.67E-08	2.47E-08
1032	1.19E-08	1.43E-08	1.75E-08	2.05E-08	2.69E-08	2.70E-08	2.53E-08
1033	1.17E-08	1.35E-08	1.56E-08	1.74E-08	2.11E-08	2.10E-08	1.95E-08
1034	1.11E-08	1.29E-08	1.49E-08	1.66E-08	2.02E-08	2.02E-08	1.86E-08
1035	1.11E-08	1.29E-08	1.50E-08	1.66E-08	2.02E-08	2.02E-08	1.88E-08
1036	1.24E-08	1.42E-08	1.64E-08	1.82E-08	2.20E-08	2.20E-08	2.04E-08
1038	1.16E-08	1.34E-08	1.55E-08	1.73E-08	2.09E-08	2.09E-08	1.94E-08
1039	1.06E-08	1.06E-08	1.06E-08	1.06E-08	1.06E-08	1.06E-08	1.06E-08
<b>Biased Statistics</b>							
Average Biased	1.17E-08	1.39E-08	1.72E-08	1.98E-08	2.62E-08	2.63E-08	2.46E-08
Std Dev Biased	4.66E-10	6.02E-10	6.97E-10	1.26E-09	1.36E-09	1.34E-09	9.11E-10
Ps99%/90% (+KTL) Biased	1.38E-08	1.68E-08	2.05E-08	2.57E-08	3.26E-08	3.26E-08	2.88E-08
Ps99%/90% (-KTL) Biased	9.49E-09	1.11E-08	1.40E-08	1.40E-08	1.99E-08	2.01E-08	2.03E-08
<b>Un-Biased Statistics</b>							
Average Un-Biased	1.16E-08	1.34E-08	1.55E-08	1.72E-08	2.09E-08	2.09E-08	1.93E-08
Std Dev Un-Biased	5.40E-10	5.67E-10	5.94E-10	6.57E-10	7.32E-10	7.24E-10	6.93E-10
Ps99%/90% (+KTL) Un-Biased	1.41E-08	1.60E-08	1.82E-08	2.03E-08	2.43E-08	2.42E-08	2.26E-08
Ps99%/90% (-KTL) Un-Biased	9.06E-09	1.07E-08	1.27E-08	1.42E-08	1.75E-08	1.75E-08	1.61E-08
<b>Specification MIN</b>	<b>-3.00E-08</b>	<b>-6.00E-08</b>	<b>-7.50E-08</b>	<b>-7.50E-08</b>	<b>-1.00E-07</b>	<b>-1.00E-07</b>	<b>-1.00E-07</b>
Status	PASS	PASS	PASS	PASS	PASS	PASS	PASS
<b>Specification MAX</b>	<b>3.00E-08</b>	<b>6.00E-08</b>	<b>7.50E-08</b>	<b>7.50E-08</b>	<b>1.00E-07</b>	<b>1.00E-07</b>	<b>1.00E-07</b>
Status	PASS	PASS	PASS	PASS	PASS	PASS	PASS

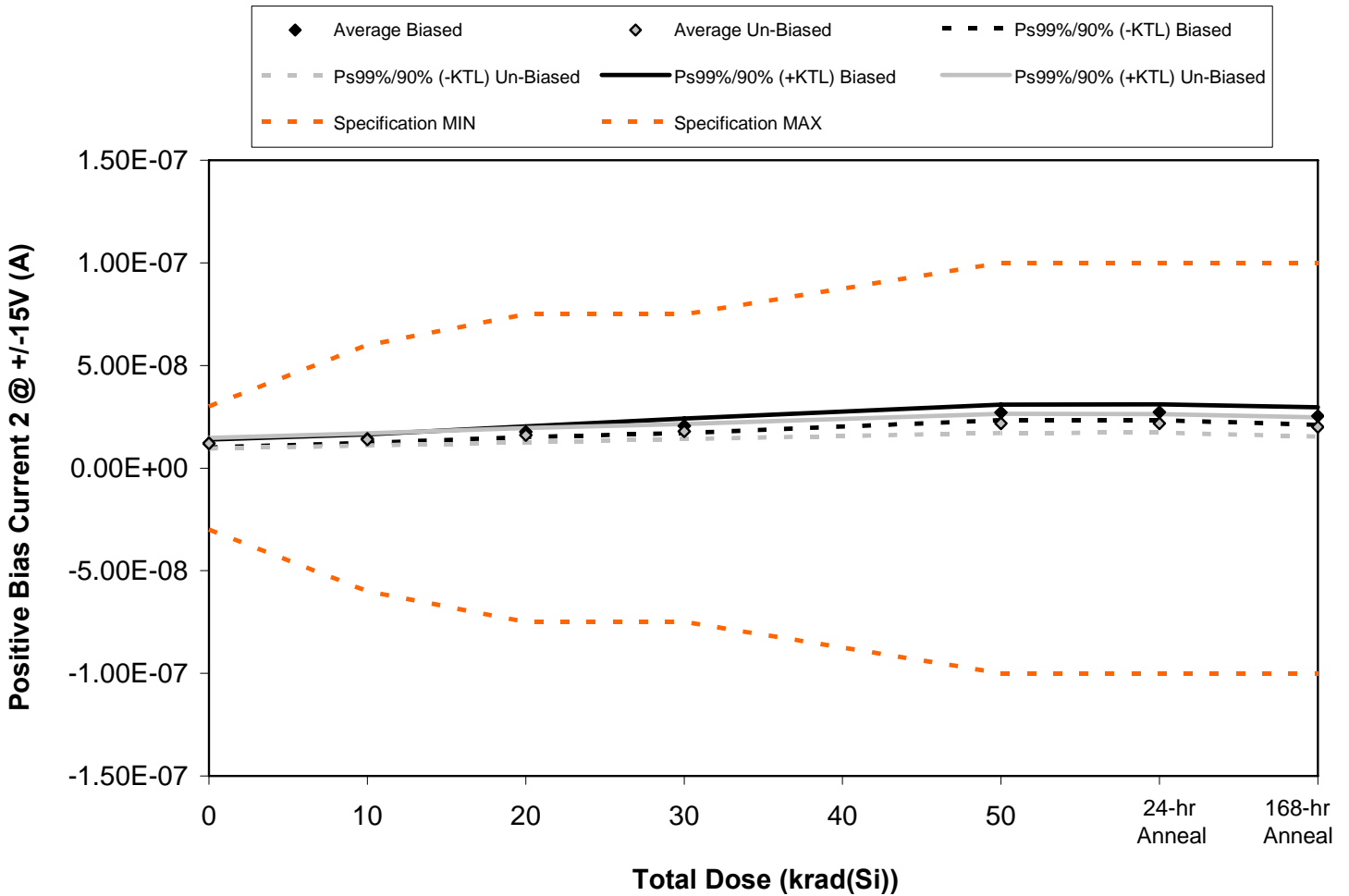

Figure 5.12. Plot of Positive Bias Current 2 @ +/-15V (A) versus total dose. The data show no significant degradation with radiation. The solid diamonds are the average of measured data points from the biased sample (devices irradiated with an electrical bias) while the shaded diamonds are the average from the unbiased sample. The black lines show the effects on the data after application of the biased KTL statistics (solid and dashed lines) while the gray lines show the effects on the data after application of the unbiased KTL statistics (solid and dashed lines). The red dashed lines are the minimum and maximum specification values as defined in the datasheet and/or test plan.



Table 5.12. Raw data for Positive Bias Current 2 @ +/-15V (A) versus total dose, including the statistical analysis, the specification and the status of the testing (pass/fail).

Positive Bias Current 2 @ +/-15V (A)	Total Dose (krad(Si))					24-hr Anneal	168-hr Anneal
	0	10	20	30	50		
Device							
1027	1.14E-08	1.37E-08	1.70E-08	1.99E-08	2.64E-08	2.64E-08	2.40E-08
1029	1.24E-08	1.47E-08	1.81E-08	2.11E-08	2.76E-08	2.77E-08	2.61E-08
1030	1.18E-08	1.41E-08	1.74E-08	1.97E-08	2.62E-08	2.63E-08	2.50E-08
1031	1.20E-08	1.43E-08	1.76E-08	2.08E-08	2.73E-08	2.74E-08	2.52E-08
1032	1.24E-08	1.48E-08	1.84E-08	2.14E-08	2.81E-08	2.82E-08	2.62E-08
1033	1.24E-08	1.42E-08	1.62E-08	1.80E-08	2.19E-08	2.18E-08	2.02E-08
1034	1.20E-08	1.40E-08	1.61E-08	1.79E-08	2.18E-08	2.18E-08	2.01E-08
1035	1.12E-08	1.29E-08	1.48E-08	1.67E-08	2.01E-08	2.02E-08	1.84E-08
1036	1.23E-08	1.41E-08	1.62E-08	1.80E-08	2.20E-08	2.20E-08	2.02E-08
1038	1.26E-08	1.46E-08	1.68E-08	1.88E-08	2.29E-08	2.28E-08	2.11E-08
1039	1.06E-08	1.07E-08	1.07E-08	1.06E-08	1.06E-08	1.06E-08	1.06E-08
<b>Biased Statistics</b>							
Average Biased	1.20E-08	1.44E-08	1.77E-08	2.06E-08	2.71E-08	2.72E-08	2.53E-08
Std Dev Biased	4.22E-10	4.43E-10	5.56E-10	7.63E-10	8.06E-10	8.26E-10	9.15E-10
Ps99%/90% (+KTL) Biased	1.40E-08	1.64E-08	2.03E-08	2.41E-08	3.09E-08	3.11E-08	2.96E-08
Ps99%/90% (-KTL) Biased	1.00E-08	1.23E-08	1.51E-08	1.70E-08	2.34E-08	2.33E-08	2.10E-08
<b>Un-Biased Statistics</b>							
Average Un-Biased	1.21E-08	1.40E-08	1.60E-08	1.79E-08	2.17E-08	2.17E-08	2.00E-08
Std Dev Un-Biased	5.64E-10	6.46E-10	7.34E-10	7.84E-10	9.95E-10	9.72E-10	9.90E-10
Ps99%/90% (+KTL) Un-Biased	1.47E-08	1.70E-08	1.94E-08	2.15E-08	2.64E-08	2.63E-08	2.46E-08
Ps99%/90% (-KTL) Un-Biased	9.46E-09	1.09E-08	1.26E-08	1.42E-08	1.71E-08	1.72E-08	1.54E-08
<b>Specification MIN</b>	<b>-3.00E-08</b>	<b>-6.00E-08</b>	<b>-7.50E-08</b>	<b>-7.50E-08</b>	<b>-1.00E-07</b>	<b>-1.00E-07</b>	<b>-1.00E-07</b>
Status	PASS	PASS	PASS	PASS	PASS	PASS	PASS
<b>Specification MAX</b>	<b>3.00E-08</b>	<b>6.00E-08</b>	<b>7.50E-08</b>	<b>7.50E-08</b>	<b>1.00E-07</b>	<b>1.00E-07</b>	<b>1.00E-07</b>
Status	PASS	PASS	PASS	PASS	PASS	PASS	PASS

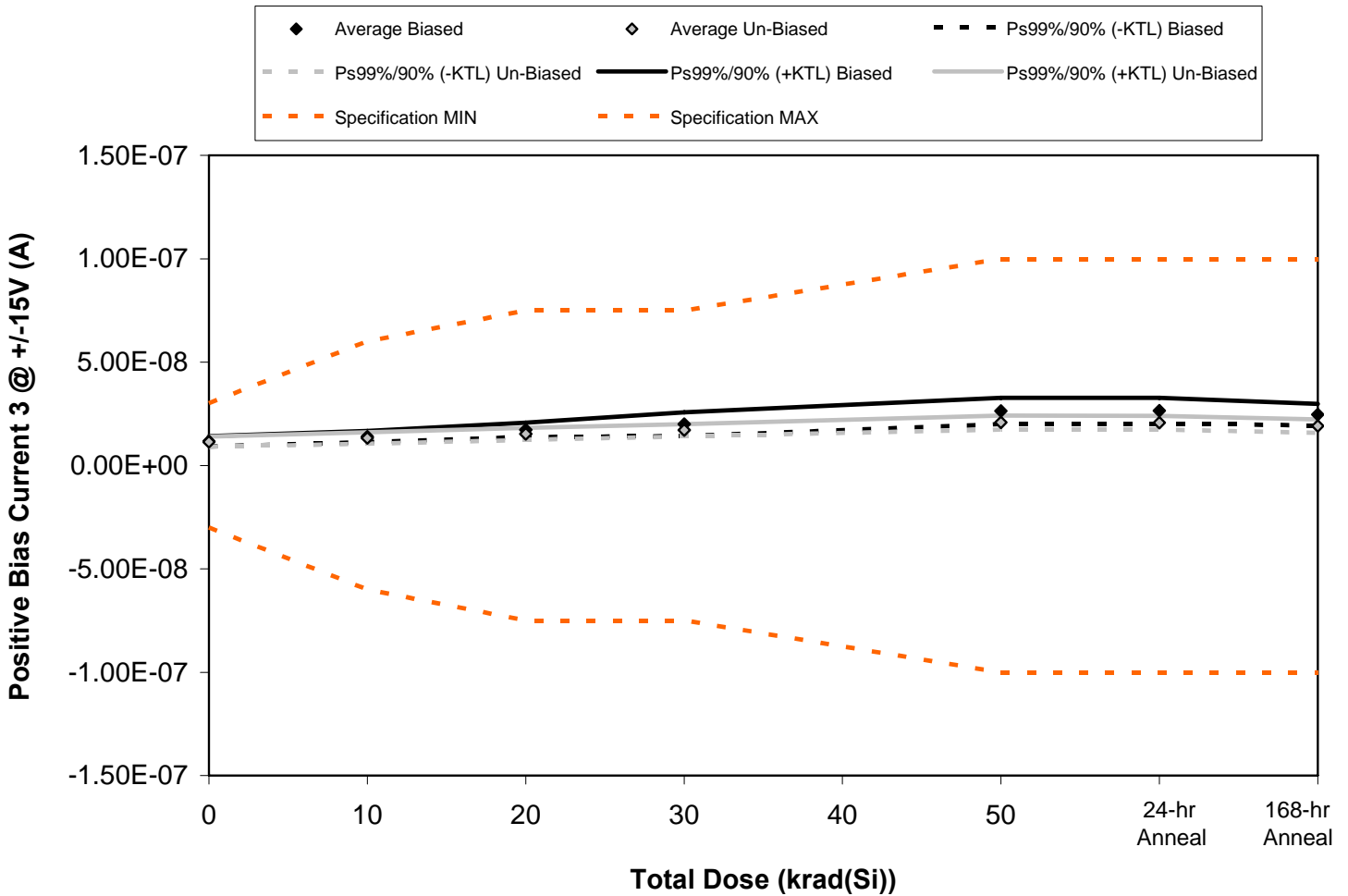

Figure 5.13. Plot of Positive Bias Current 3 @ +/-15V (A) versus total dose. The data show no significant degradation with radiation. The solid diamonds are the average of measured data points from the biased sample (devices irradiated with an electrical bias) while the shaded diamonds are the average from the unbiased sample. The black lines show the effects on the data after application of the biased KTL statistics (solid and dashed lines) while the gray lines show the effects on the data after application of the unbiased KTL statistics (solid and dashed lines). The red dashed lines are the minimum and maximum specification values as defined in the datasheet and/or test plan.





Table 5.13. Raw data for Positive Bias Current 3 @ +/-15V (A) versus total dose, including the statistical analysis, the specification and the status of the testing (pass/fail).

Positive Bias Current 3 @ +/-15V (A)	Total Dose (krad(Si))					24-hr Anneal	168-hr Anneal
	0	10	20	30	50		
Device							
1027	1.10E-08	1.32E-08	1.64E-08	1.94E-08	2.54E-08	2.56E-08	2.32E-08
1029	1.18E-08	1.40E-08	1.73E-08	2.03E-08	2.65E-08	2.66E-08	2.49E-08
1030	1.13E-08	1.36E-08	1.66E-08	1.81E-08	2.46E-08	2.48E-08	2.37E-08
1031	1.22E-08	1.47E-08	1.80E-08	2.10E-08	2.77E-08	2.78E-08	2.55E-08
1032	1.21E-08	1.45E-08	1.80E-08	2.10E-08	2.77E-08	2.77E-08	2.57E-08
1033	1.20E-08	1.38E-08	1.57E-08	1.75E-08	2.12E-08	2.11E-08	1.94E-08
1034	1.12E-08	1.30E-08	1.50E-08	1.68E-08	2.04E-08	2.04E-08	1.88E-08
1035	1.07E-08	1.24E-08	1.43E-08	1.61E-08	1.96E-08	1.95E-08	1.79E-08
1036	1.20E-08	1.38E-08	1.58E-08	1.76E-08	2.14E-08	2.13E-08	1.96E-08
1038	1.16E-08	1.34E-08	1.55E-08	1.74E-08	2.11E-08	2.10E-08	1.95E-08
1039	1.02E-08	1.03E-08	1.03E-08	1.02E-08	1.02E-08	1.02E-08	1.02E-08
<b>Biased Statistics</b>							
Average Biased	1.17E-08	1.40E-08	1.73E-08	2.00E-08	2.64E-08	2.65E-08	2.46E-08
Std Dev Biased	5.27E-10	5.91E-10	7.30E-10	1.24E-09	1.35E-09	1.32E-09	1.13E-09
Ps99%/90% (+KTL) Biased	1.41E-08	1.68E-08	2.07E-08	2.57E-08	3.27E-08	3.26E-08	2.98E-08
Ps99%/90% (-KTL) Biased	9.21E-09	1.12E-08	1.38E-08	1.42E-08	2.01E-08	2.03E-08	1.93E-08
<b>Un-Biased Statistics</b>							
Average Un-Biased	1.15E-08	1.33E-08	1.53E-08	1.71E-08	2.07E-08	2.07E-08	1.90E-08
Std Dev Un-Biased	5.30E-10	5.92E-10	6.20E-10	6.32E-10	7.21E-10	7.21E-10	6.87E-10
Ps99%/90% (+KTL) Un-Biased	1.40E-08	1.60E-08	1.82E-08	2.00E-08	2.41E-08	2.40E-08	2.23E-08
Ps99%/90% (-KTL) Un-Biased	9.02E-09	1.05E-08	1.24E-08	1.41E-08	1.74E-08	1.73E-08	1.58E-08
<b>Specification MIN</b>	<b>-3.00E-08</b>	<b>-6.00E-08</b>	<b>-7.50E-08</b>	<b>-7.50E-08</b>	<b>-1.00E-07</b>	<b>-1.00E-07</b>	<b>-1.00E-07</b>
Status	PASS	PASS	PASS	PASS	PASS	PASS	PASS
<b>Specification MAX</b>	<b>3.00E-08</b>	<b>6.00E-08</b>	<b>7.50E-08</b>	<b>7.50E-08</b>	<b>1.00E-07</b>	<b>1.00E-07</b>	<b>1.00E-07</b>
Status	PASS	PASS	PASS	PASS	PASS	PASS	PASS

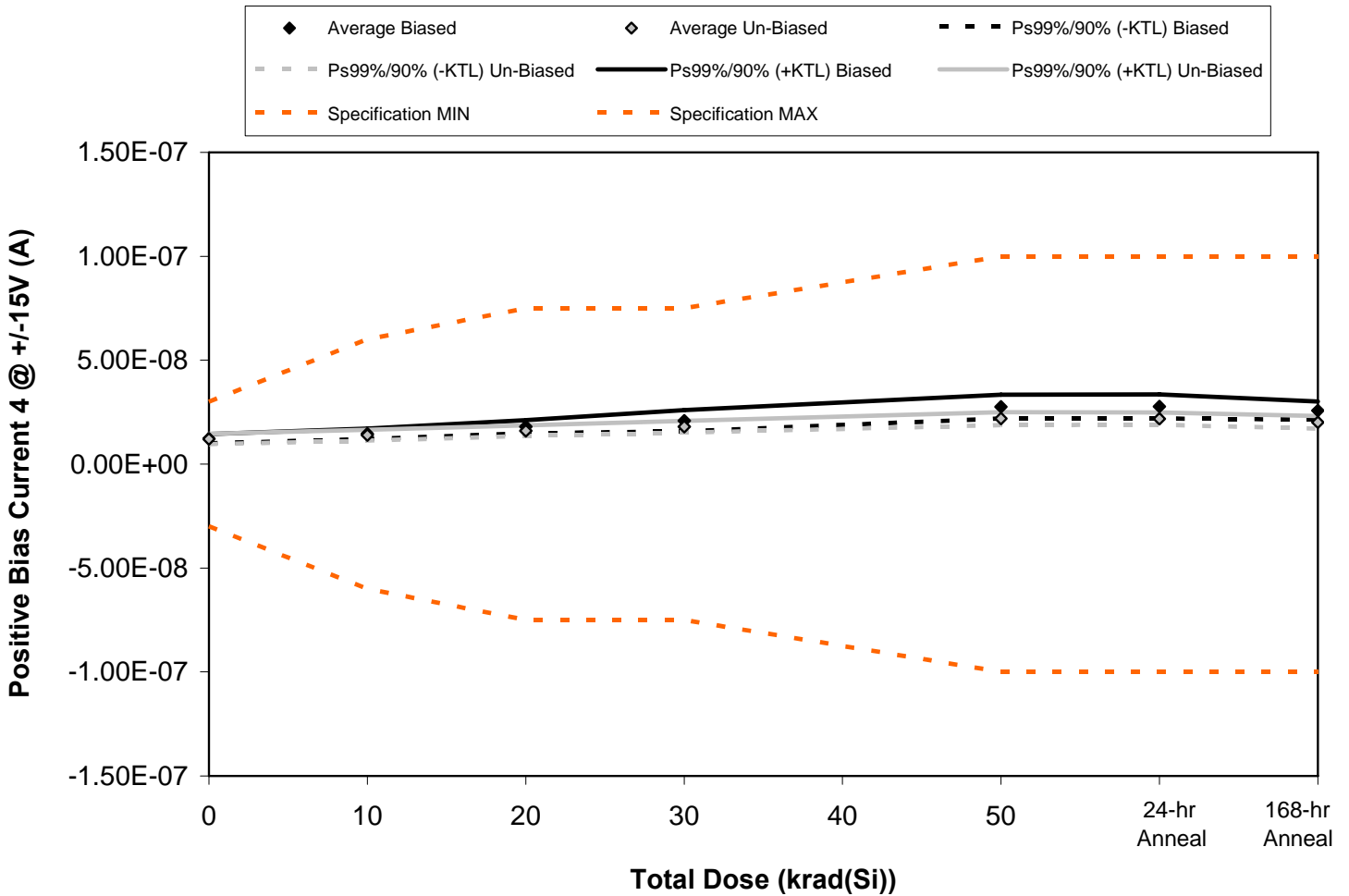

Figure 5.14. Plot of Positive Bias Current 4 @ +/-15V (A) versus total dose. The data show no significant degradation with radiation. The solid diamonds are the average of measured data points from the biased sample (devices irradiated with an electrical bias) while the shaded diamonds are the average from the unbiased sample. The black lines show the effects on the data after application of the biased KTL statistics (solid and dashed lines) while the gray lines show the effects on the data after application of the unbiased KTL statistics (solid and dashed lines). The red dashed lines are the minimum and maximum specification values as defined in the datasheet and/or test plan.



Table 5.14. Raw data for Positive Bias Current 4 @ +/-15V (A) versus total dose, including the statistical analysis, the specification and the status of the testing (pass/fail).

Positive Bias Current 4 @ +/-15V (A)	Total Dose (krad(Si))					24-hr Anneal	168-hr Anneal
	0	10	20	30	50		
Device							
1027	1.23E-08	1.51E-08	1.86E-08	2.19E-08	2.87E-08	2.90E-08	2.61E-08
1029	1.18E-08	1.41E-08	1.74E-08	2.04E-08	2.67E-08	2.68E-08	2.49E-08
1030	1.20E-08	1.42E-08	1.75E-08	1.94E-08	2.62E-08	2.63E-08	2.53E-08
1031	1.20E-08	1.45E-08	1.77E-08	2.08E-08	2.73E-08	2.74E-08	2.52E-08
1032	1.30E-08	1.53E-08	1.89E-08	2.21E-08	2.90E-08	2.91E-08	2.72E-08
1033	1.20E-08	1.39E-08	1.60E-08	1.80E-08	2.19E-08	2.18E-08	2.01E-08
1034	1.15E-08	1.33E-08	1.54E-08	1.72E-08	2.11E-08	2.11E-08	1.93E-08
1035	1.20E-08	1.40E-08	1.60E-08	1.79E-08	2.18E-08	2.18E-08	2.01E-08
1036	1.30E-08	1.48E-08	1.70E-08	1.89E-08	2.29E-08	2.29E-08	2.11E-08
1038	1.19E-08	1.38E-08	1.59E-08	1.78E-08	2.16E-08	2.16E-08	2.01E-08
1039	1.10E-08	1.10E-08	1.10E-08	1.10E-08	1.10E-08	1.10E-08	1.10E-08
<b>Biased Statistics</b>							
Average Biased	1.22E-08	1.46E-08	1.80E-08	2.09E-08	2.76E-08	2.77E-08	2.57E-08
Std Dev Biased	4.76E-10	5.34E-10	6.79E-10	1.10E-09	1.23E-09	1.25E-09	9.39E-10
Ps99%/90% (+KTL) Biased	1.45E-08	1.71E-08	2.12E-08	2.60E-08	3.33E-08	3.35E-08	3.01E-08
Ps99%/90% (-KTL) Biased	1.00E-08	1.21E-08	1.48E-08	1.58E-08	2.19E-08	2.19E-08	2.14E-08
<b>Un-Biased Statistics</b>							
Average Un-Biased	1.21E-08	1.40E-08	1.61E-08	1.80E-08	2.19E-08	2.19E-08	2.01E-08
Std Dev Un-Biased	5.41E-10	5.60E-10	5.50E-10	6.08E-10	6.58E-10	6.45E-10	6.52E-10
Ps99%/90% (+KTL) Un-Biased	1.46E-08	1.66E-08	1.86E-08	2.08E-08	2.49E-08	2.49E-08	2.32E-08
Ps99%/90% (-KTL) Un-Biased	9.57E-09	1.13E-08	1.35E-08	1.51E-08	1.88E-08	1.89E-08	1.71E-08
<b>Specification MIN</b>	<b>-3.00E-08</b>	<b>-6.00E-08</b>	<b>-7.50E-08</b>	<b>-7.50E-08</b>	<b>-1.00E-07</b>	<b>-1.00E-07</b>	<b>-1.00E-07</b>
Status	PASS	PASS	PASS	PASS	PASS	PASS	PASS
<b>Specification MAX</b>	<b>3.00E-08</b>	<b>6.00E-08</b>	<b>7.50E-08</b>	<b>7.50E-08</b>	<b>1.00E-07</b>	<b>1.00E-07</b>	<b>1.00E-07</b>
Status	PASS	PASS	PASS	PASS	PASS	PASS	PASS

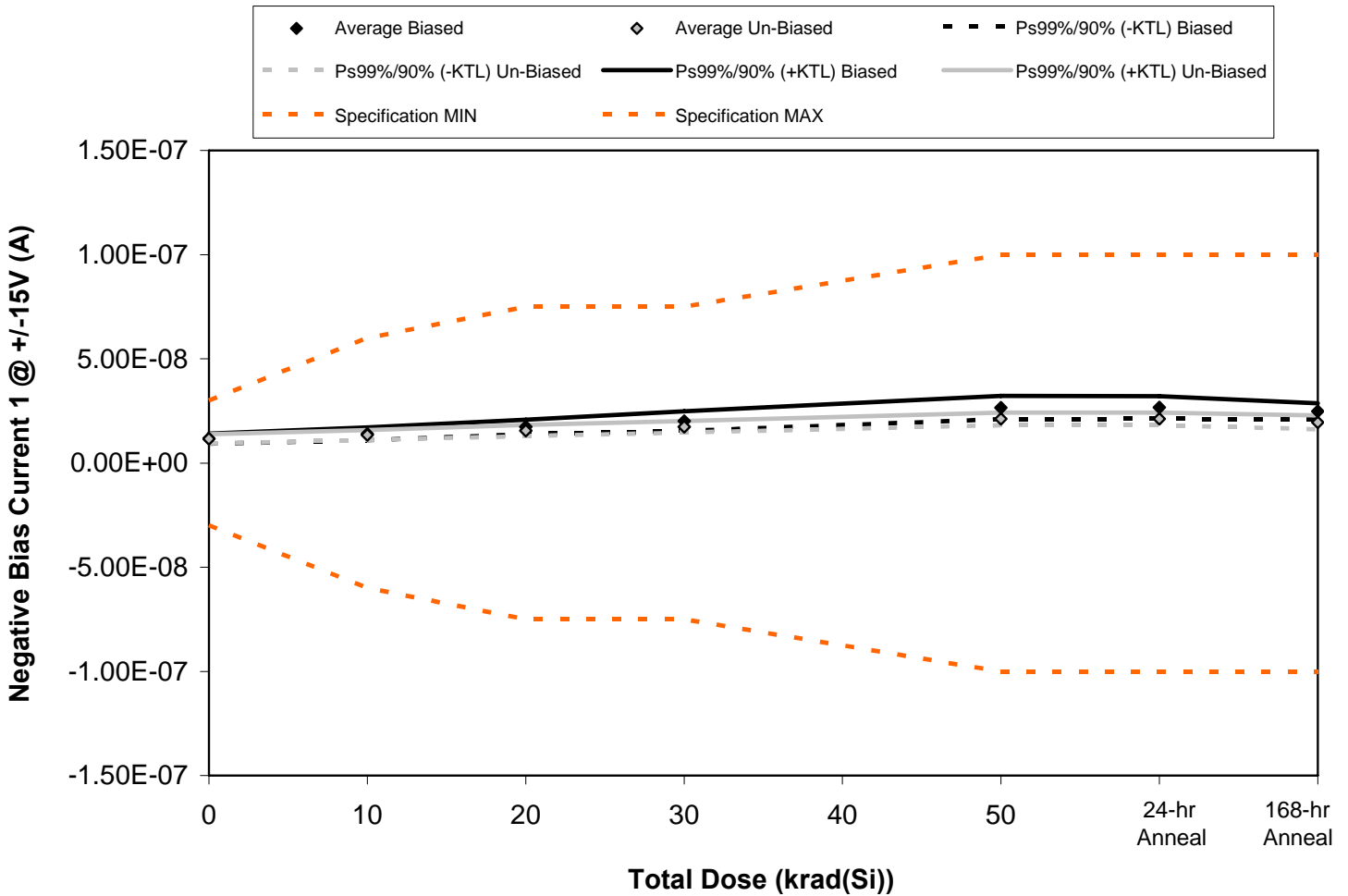

Figure 5.15. Plot of Negative Bias Current 1 @ +/-15V (A) versus total dose. The data show no significant degradation with radiation. The solid diamonds are the average of measured data points from the biased sample (devices irradiated with an electrical bias) while the shaded diamonds are the average from the unbiased sample. The black lines show the effects on the data after application of the biased KTL statistics (solid and dashed lines) while the gray lines show the effects on the data after application of the unbiased KTL statistics (solid and dashed lines). The red dashed lines are the minimum and maximum specification values as defined in the datasheet and/or test plan.



Table 5.15. Raw data for Negative Bias Current 1 @ +/-15V (A) versus total dose, including the statistical analysis, the specification and the status of the testing (pass/fail).

Negative Bias Current 1 @ +/-15V (A)	Total Dose (krad(Si))					24-hr Anneal	168-hr Anneal
	0	10	20	30	50		
Device							
1027	1.23E-08	1.49E-08	1.83E-08	2.14E-08	2.83E-08	2.83E-08	2.56E-08
1029	1.09E-08	1.31E-08	1.63E-08	1.91E-08	2.53E-08	2.54E-08	2.35E-08
1030	1.17E-08	1.39E-08	1.72E-08	1.91E-08	2.57E-08	2.58E-08	2.48E-08
1031	1.16E-08	1.39E-08	1.72E-08	2.03E-08	2.67E-08	2.68E-08	2.47E-08
1032	1.19E-08	1.43E-08	1.77E-08	2.07E-08	2.71E-08	2.72E-08	2.54E-08
1033	1.17E-08	1.36E-08	1.58E-08	1.75E-08	2.14E-08	2.13E-08	1.97E-08
1034	1.10E-08	1.29E-08	1.50E-08	1.67E-08	2.06E-08	2.05E-08	1.87E-08
1035	1.12E-08	1.31E-08	1.52E-08	1.69E-08	2.07E-08	2.06E-08	1.89E-08
1036	1.23E-08	1.42E-08	1.65E-08	1.82E-08	2.22E-08	2.21E-08	2.05E-08
1038	1.16E-08	1.35E-08	1.56E-08	1.75E-08	2.12E-08	2.12E-08	1.97E-08
1039	1.06E-08	1.06E-08	1.06E-08	1.06E-08	1.07E-08	1.06E-08	1.06E-08
<b>Biased Statistics</b>							
Average Biased	1.17E-08	1.40E-08	1.73E-08	2.01E-08	2.66E-08	2.67E-08	2.48E-08
Std Dev Biased	5.12E-10	6.54E-10	7.42E-10	1.00E-09	1.19E-09	1.15E-09	8.18E-10
Ps99%/90% (+KTL) Biased	1.41E-08	1.71E-08	2.08E-08	2.48E-08	3.21E-08	3.21E-08	2.86E-08
Ps99%/90% (-KTL) Biased	9.29E-09	1.09E-08	1.39E-08	1.54E-08	2.11E-08	2.13E-08	2.10E-08
<b>Un-Biased Statistics</b>							
Average Un-Biased	1.16E-08	1.35E-08	1.56E-08	1.74E-08	2.12E-08	2.12E-08	1.95E-08
Std Dev Un-Biased	4.79E-10	5.03E-10	5.77E-10	5.79E-10	6.45E-10	6.43E-10	7.20E-10
Ps99%/90% (+KTL) Un-Biased	1.38E-08	1.58E-08	1.83E-08	2.01E-08	2.42E-08	2.42E-08	2.29E-08
Ps99%/90% (-KTL) Un-Biased	9.33E-09	1.11E-08	1.29E-08	1.47E-08	1.82E-08	1.81E-08	1.61E-08
<b>Specification MIN</b>	<b>-3.00E-08</b>	<b>-6.00E-08</b>	<b>-7.50E-08</b>	<b>-7.50E-08</b>	<b>-1.00E-07</b>	<b>-1.00E-07</b>	<b>-1.00E-07</b>
Status	PASS	PASS	PASS	PASS	PASS	PASS	PASS
<b>Specification MAX</b>	<b>3.00E-08</b>	<b>6.00E-08</b>	<b>7.50E-08</b>	<b>7.50E-08</b>	<b>1.00E-07</b>	<b>1.00E-07</b>	<b>1.00E-07</b>
Status	PASS	PASS	PASS	PASS	PASS	PASS	PASS

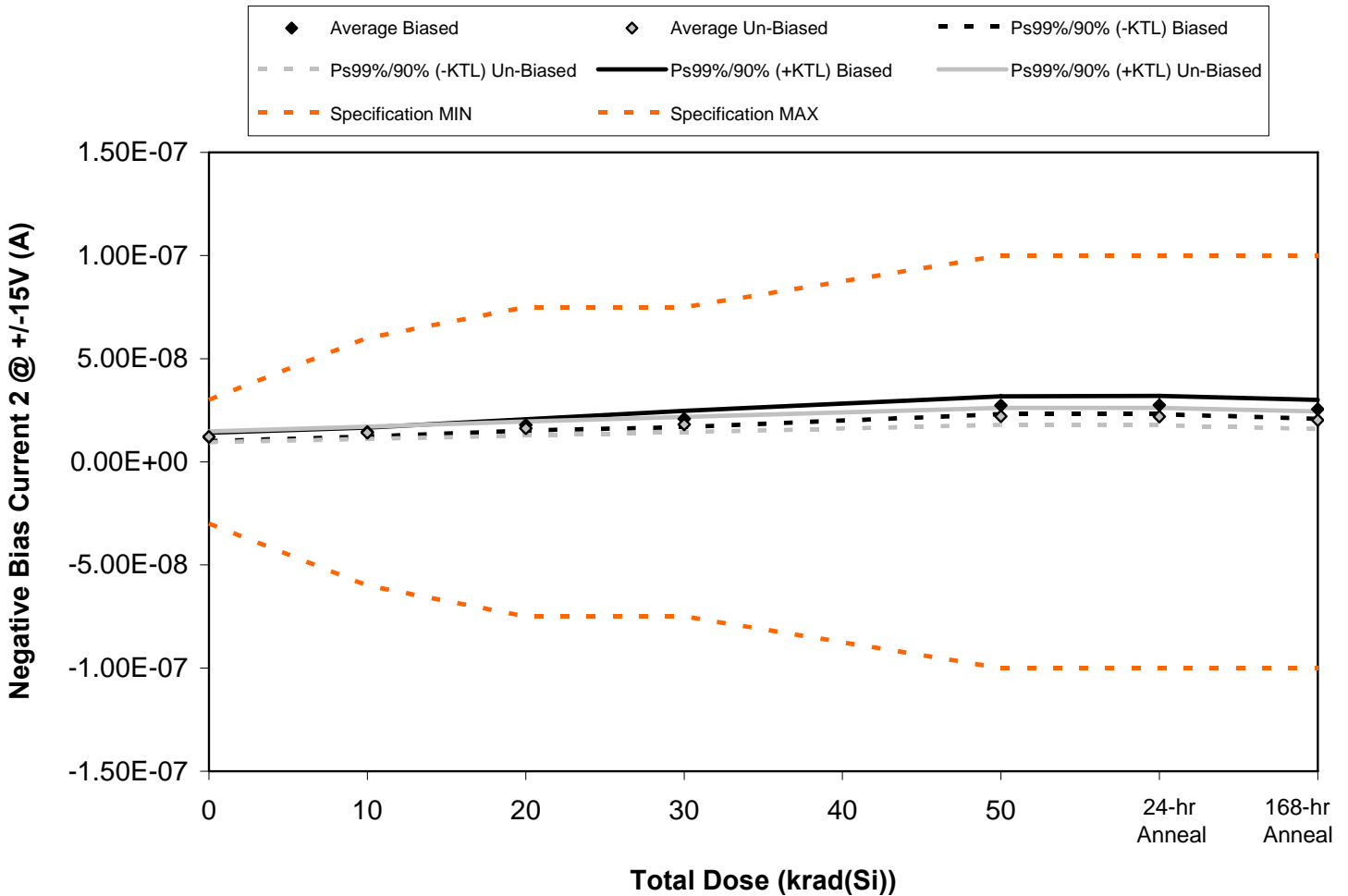

Figure 5.16. Plot of Negative Bias Current 2 @ +/-15V (A) versus total dose. The data show no significant degradation with radiation. The solid diamonds are the average of measured data points from the biased sample (devices irradiated with an electrical bias) while the shaded diamonds are the average from the unbiased sample. The black lines show the effects on the data after application of the biased KTL statistics (solid and dashed lines) while the gray lines show the effects on the data after application of the unbiased KTL statistics (solid and dashed lines). The red dashed lines are the minimum and maximum specification values as defined in the datasheet and/or test plan.



Table 5.16. Raw data for Negative Bias Current 2 @ +/-15V (A) versus total dose, including the statistical analysis, the specification and the status of the testing (pass/fail).

Negative Bias Current 2 @ +/-15V (A)	Total Dose (krad(Si))					24-hr Anneal	168-hr Anneal
	0	10	20	30	50		
Device							
1027	1.14E-08	1.38E-08	1.71E-08	2.01E-08	2.65E-08	2.65E-08	2.41E-08
1029	1.23E-08	1.46E-08	1.81E-08	2.12E-08	2.78E-08	2.79E-08	2.61E-08
1030	1.19E-08	1.42E-08	1.75E-08	1.98E-08	2.64E-08	2.65E-08	2.50E-08
1031	1.21E-08	1.45E-08	1.79E-08	2.10E-08	2.77E-08	2.78E-08	2.55E-08
1032	1.25E-08	1.50E-08	1.86E-08	2.18E-08	2.86E-08	2.87E-08	2.66E-08
1033	1.25E-08	1.44E-08	1.65E-08	1.84E-08	2.23E-08	2.21E-08	2.05E-08
1034	1.19E-08	1.39E-08	1.59E-08	1.78E-08	2.17E-08	2.16E-08	1.99E-08
1035	1.13E-08	1.30E-08	1.51E-08	1.69E-08	2.07E-08	2.06E-08	1.88E-08
1036	1.23E-08	1.42E-08	1.64E-08	1.82E-08	2.22E-08	2.22E-08	2.05E-08
1038	1.26E-08	1.46E-08	1.70E-08	1.90E-08	2.31E-08	2.31E-08	2.13E-08
1039	1.07E-08	1.07E-08	1.08E-08	1.07E-08	1.07E-08	1.07E-08	1.07E-08
<b>Biased Statistics</b>							
Average Biased	1.20E-08	1.44E-08	1.78E-08	2.08E-08	2.74E-08	2.75E-08	2.55E-08
Std Dev Biased	4.31E-10	4.62E-10	5.78E-10	8.26E-10	9.29E-10	9.45E-10	9.74E-10
Ps99%/90% (+KTL) Biased	1.41E-08	1.66E-08	2.05E-08	2.46E-08	3.17E-08	3.19E-08	3.00E-08
Ps99%/90% (-KTL) Biased	1.00E-08	1.23E-08	1.51E-08	1.69E-08	2.31E-08	2.31E-08	2.09E-08
<b>Un-Biased Statistics</b>							
Average Un-Biased	1.21E-08	1.40E-08	1.62E-08	1.81E-08	2.20E-08	2.19E-08	2.02E-08
Std Dev Un-Biased	5.59E-10	6.37E-10	7.16E-10	7.82E-10	8.83E-10	9.03E-10	9.07E-10
Ps99%/90% (+KTL) Un-Biased	1.47E-08	1.70E-08	1.95E-08	2.17E-08	2.61E-08	2.61E-08	2.44E-08
Ps99%/90% (-KTL) Un-Biased	9.51E-09	1.11E-08	1.28E-08	1.44E-08	1.79E-08	1.77E-08	1.60E-08
<b>Specification MIN</b>	<b>-3.00E-08</b>	<b>-6.00E-08</b>	<b>-7.50E-08</b>	<b>-7.50E-08</b>	<b>-1.00E-07</b>	<b>-1.00E-07</b>	<b>-1.00E-07</b>
Status	PASS	PASS	PASS	PASS	PASS	PASS	PASS
<b>Specification MAX</b>	<b>3.00E-08</b>	<b>6.00E-08</b>	<b>7.50E-08</b>	<b>7.50E-08</b>	<b>1.00E-07</b>	<b>1.00E-07</b>	<b>1.00E-07</b>
Status	PASS	PASS	PASS	PASS	PASS	PASS	PASS

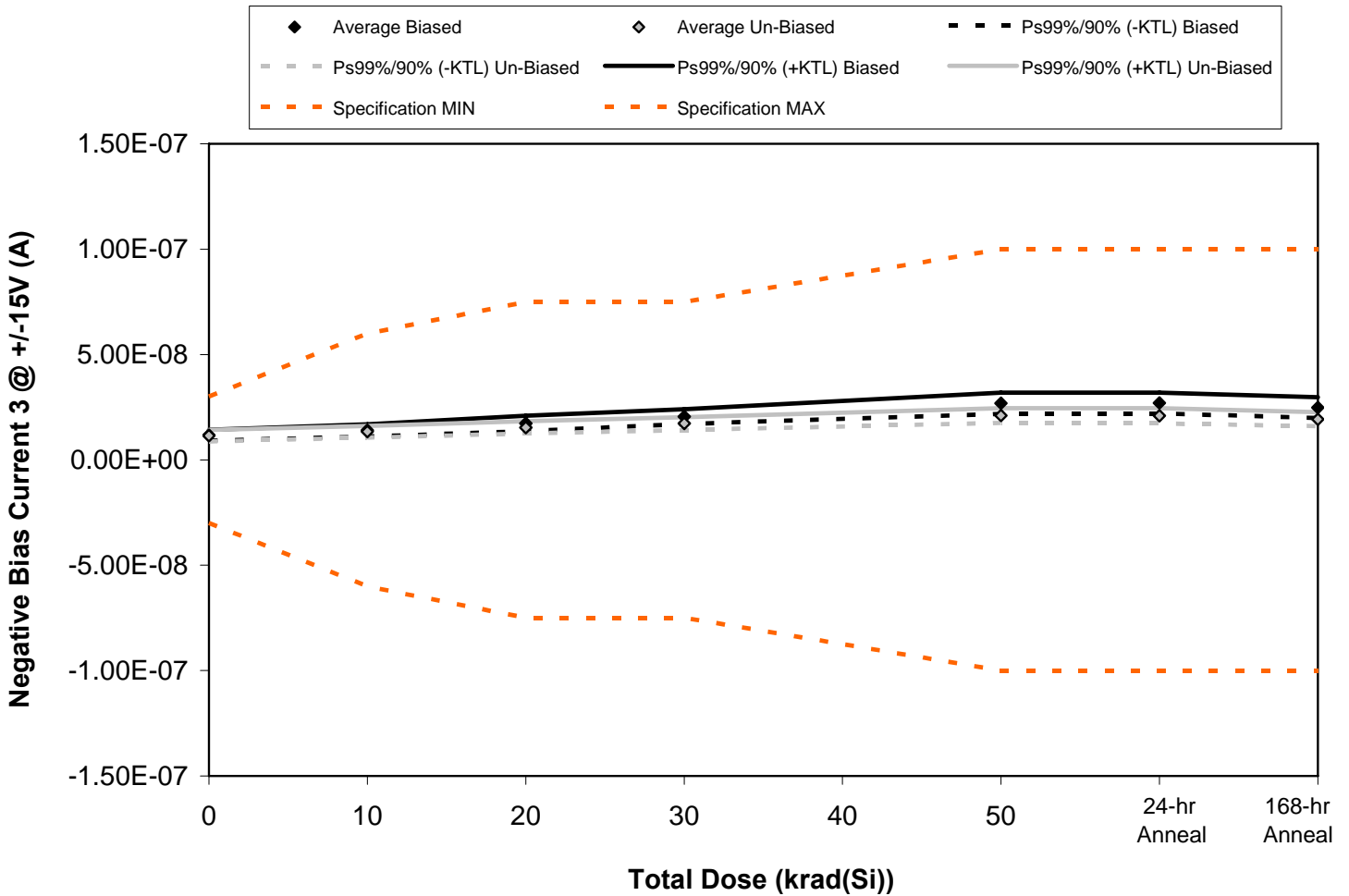

Figure 5.17. Plot of Negative Bias Current 3 @ +/-15V (A) versus total dose. The data show no significant degradation with radiation. The solid diamonds are the average of measured data points from the biased sample (devices irradiated with an electrical bias) while the shaded diamonds are the average from the unbiased sample. The black lines show the effects on the data after application of the biased KTL statistics (solid and dashed lines) while the gray lines show the effects on the data after application of the unbiased KTL statistics (solid and dashed lines). The red dashed lines are the minimum and maximum specification values as defined in the datasheet and/or test plan.





Table 5.17. Raw data for Negative Bias Current 3 @ +/-15V (A) versus total dose, including the statistical analysis, the specification and the status of the testing (pass/fail).

Negative Bias Current 3 @ +/-15V (A)	Total Dose (krad(Si))					24-hr Anneal	168-hr Anneal
	0	10	20	30	50		
Device							
1027	1.09E-08	1.32E-08	1.65E-08	1.94E-08	2.55E-08	2.57E-08	2.33E-08
1029	1.19E-08	1.41E-08	1.73E-08	2.04E-08	2.68E-08	2.69E-08	2.50E-08
1030	1.13E-08	1.36E-08	1.65E-08	2.06E-08	2.62E-08	2.64E-08	2.44E-08
1031	1.23E-08	1.47E-08	1.81E-08	2.13E-08	2.79E-08	2.80E-08	2.57E-08
1032	1.21E-08	1.45E-08	1.80E-08	2.12E-08	2.80E-08	2.81E-08	2.58E-08
1033	1.21E-08	1.38E-08	1.59E-08	1.76E-08	2.15E-08	2.13E-08	1.97E-08
1034	1.12E-08	1.31E-08	1.52E-08	1.70E-08	2.06E-08	2.06E-08	1.91E-08
1035	1.07E-08	1.25E-08	1.44E-08	1.62E-08	1.99E-08	1.97E-08	1.82E-08
1036	1.20E-08	1.39E-08	1.60E-08	1.79E-08	2.17E-08	2.16E-08	1.99E-08
1038	1.16E-08	1.35E-08	1.56E-08	1.75E-08	2.14E-08	2.12E-08	1.97E-08
1039	1.02E-08	1.03E-08	1.04E-08	1.03E-08	1.02E-08	1.03E-08	1.03E-08
<b>Biased Statistics</b>							
Average Biased	1.17E-08	1.40E-08	1.73E-08	2.06E-08	2.69E-08	2.70E-08	2.49E-08
Std Dev Biased	5.58E-10	6.25E-10	7.84E-10	7.49E-10	1.09E-09	1.05E-09	1.05E-09
Ps99%/90% (+KTL) Biased	1.43E-08	1.69E-08	2.10E-08	2.41E-08	3.20E-08	3.19E-08	2.98E-08
Ps99%/90% (-KTL) Biased	9.08E-09	1.11E-08	1.36E-08	1.71E-08	2.18E-08	2.21E-08	2.00E-08
<b>Un-Biased Statistics</b>							
Average Un-Biased	1.15E-08	1.33E-08	1.54E-08	1.72E-08	2.10E-08	2.09E-08	1.93E-08
Std Dev Un-Biased	5.85E-10	5.96E-10	6.24E-10	6.41E-10	7.45E-10	7.75E-10	7.08E-10
Ps99%/90% (+KTL) Un-Biased	1.42E-08	1.61E-08	1.83E-08	2.02E-08	2.45E-08	2.45E-08	2.26E-08
Ps99%/90% (-KTL) Un-Biased	8.78E-09	1.06E-08	1.25E-08	1.43E-08	1.76E-08	1.73E-08	1.60E-08
<b>Specification MIN</b>	<b>-3.00E-08</b>	<b>-6.00E-08</b>	<b>-7.50E-08</b>	<b>-7.50E-08</b>	<b>-1.00E-07</b>	<b>-1.00E-07</b>	<b>-1.00E-07</b>
Status	PASS	PASS	PASS	PASS	PASS	PASS	PASS
<b>Specification MAX</b>	<b>3.00E-08</b>	<b>6.00E-08</b>	<b>7.50E-08</b>	<b>7.50E-08</b>	<b>1.00E-07</b>	<b>1.00E-07</b>	<b>1.00E-07</b>
Status	PASS	PASS	PASS	PASS	PASS	PASS	PASS

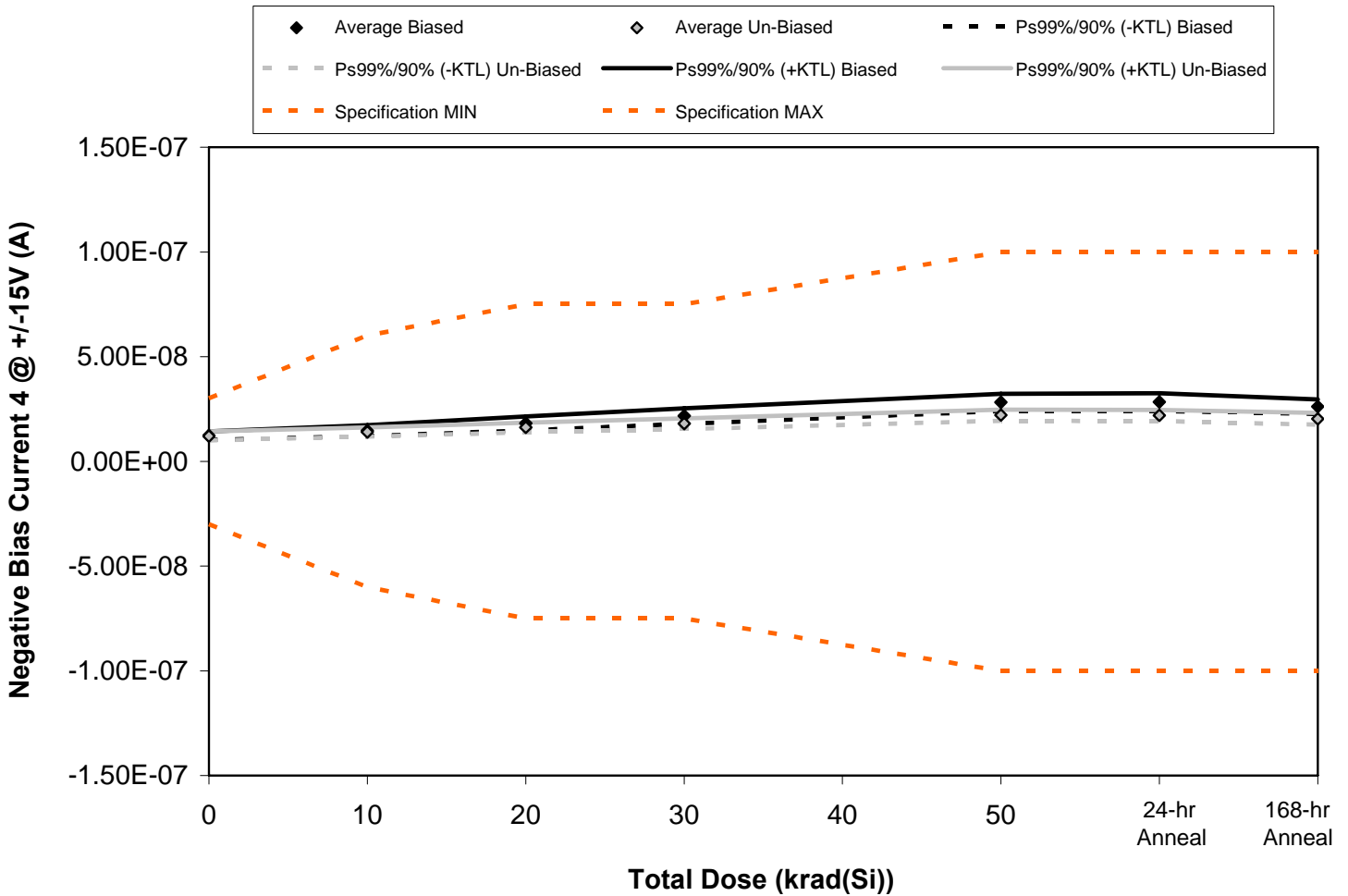

Figure 5.18. Plot of Negative Bias Current 4 @ +/-15V (A) versus total dose. The data show no significant degradation with radiation. The solid diamonds are the average of measured data points from the biased sample (devices irradiated with an electrical bias) while the shaded diamonds are the average from the unbiased sample. The black lines show the effects on the data after application of the biased KTL statistics (solid and dashed lines) while the gray lines show the effects on the data after application of the unbiased KTL statistics (solid and dashed lines). The red dashed lines are the minimum and maximum specification values as defined in the datasheet and/or test plan.



Table 5.18. Raw data for Negative Bias Current 4 @ +/-15V (A) versus total dose, including the statistical analysis, the specification and the status of the testing (pass/fail).

Negative Bias Current 4 @ +/-15V (A)	Total Dose (krad(Si))					24-hr Anneal	168-hr Anneal
	0	10	20	30	50		
Device							
1027	1.25E-08	1.52E-08	1.89E-08	2.21E-08	2.91E-08	2.92E-08	2.63E-08
1029	1.18E-08	1.41E-08	1.75E-08	2.06E-08	2.71E-08	2.71E-08	2.53E-08
1030	1.21E-08	1.43E-08	1.76E-08	2.25E-08	2.83E-08	2.84E-08	2.63E-08
1031	1.21E-08	1.46E-08	1.79E-08	2.11E-08	2.76E-08	2.77E-08	2.56E-08
1032	1.29E-08	1.54E-08	1.90E-08	2.21E-08	2.90E-08	2.91E-08	2.72E-08
1033	1.21E-08	1.40E-08	1.62E-08	1.80E-08	2.20E-08	2.18E-08	2.03E-08
1034	1.15E-08	1.34E-08	1.56E-08	1.74E-08	2.14E-08	2.12E-08	1.95E-08
1035	1.22E-08	1.41E-08	1.63E-08	1.82E-08	2.21E-08	2.21E-08	2.05E-08
1036	1.28E-08	1.47E-08	1.70E-08	1.89E-08	2.29E-08	2.28E-08	2.12E-08
1038	1.20E-08	1.38E-08	1.60E-08	1.78E-08	2.18E-08	2.16E-08	2.01E-08
1039	1.10E-08	1.11E-08	1.10E-08	1.11E-08	1.10E-08	1.10E-08	1.11E-08
<b>Biased Statistics</b>							
Average Biased	1.23E-08	1.47E-08	1.82E-08	2.17E-08	2.82E-08	2.83E-08	2.61E-08
Std Dev Biased	4.42E-10	5.64E-10	7.14E-10	7.94E-10	8.77E-10	9.02E-10	7.38E-10
Ps99%/90% (+KTL) Biased	1.43E-08	1.73E-08	2.15E-08	2.54E-08	3.23E-08	3.25E-08	2.96E-08
Ps99%/90% (-KTL) Biased	1.02E-08	1.21E-08	1.48E-08	1.80E-08	2.41E-08	2.41E-08	2.27E-08
<b>Un-Biased Statistics</b>							
Average Un-Biased	1.21E-08	1.40E-08	1.62E-08	1.80E-08	2.20E-08	2.19E-08	2.03E-08
Std Dev Un-Biased	4.66E-10	4.72E-10	4.91E-10	5.47E-10	5.78E-10	5.78E-10	6.07E-10
Ps99%/90% (+KTL) Un-Biased	1.43E-08	1.62E-08	1.85E-08	2.06E-08	2.47E-08	2.46E-08	2.32E-08
Ps99%/90% (-KTL) Un-Biased	9.93E-09	1.18E-08	1.39E-08	1.55E-08	1.93E-08	1.92E-08	1.75E-08
<b>Specification MIN</b>	<b>-3.00E-08</b>	<b>-6.00E-08</b>	<b>-7.50E-08</b>	<b>-7.50E-08</b>	<b>-1.00E-07</b>	<b>-1.00E-07</b>	<b>-1.00E-07</b>
Status	PASS	PASS	PASS	PASS	PASS	PASS	PASS
<b>Specification MAX</b>	<b>3.00E-08</b>	<b>6.00E-08</b>	<b>7.50E-08</b>	<b>7.50E-08</b>	<b>1.00E-07</b>	<b>1.00E-07</b>	<b>1.00E-07</b>
Status	PASS	PASS	PASS	PASS	PASS	PASS	PASS

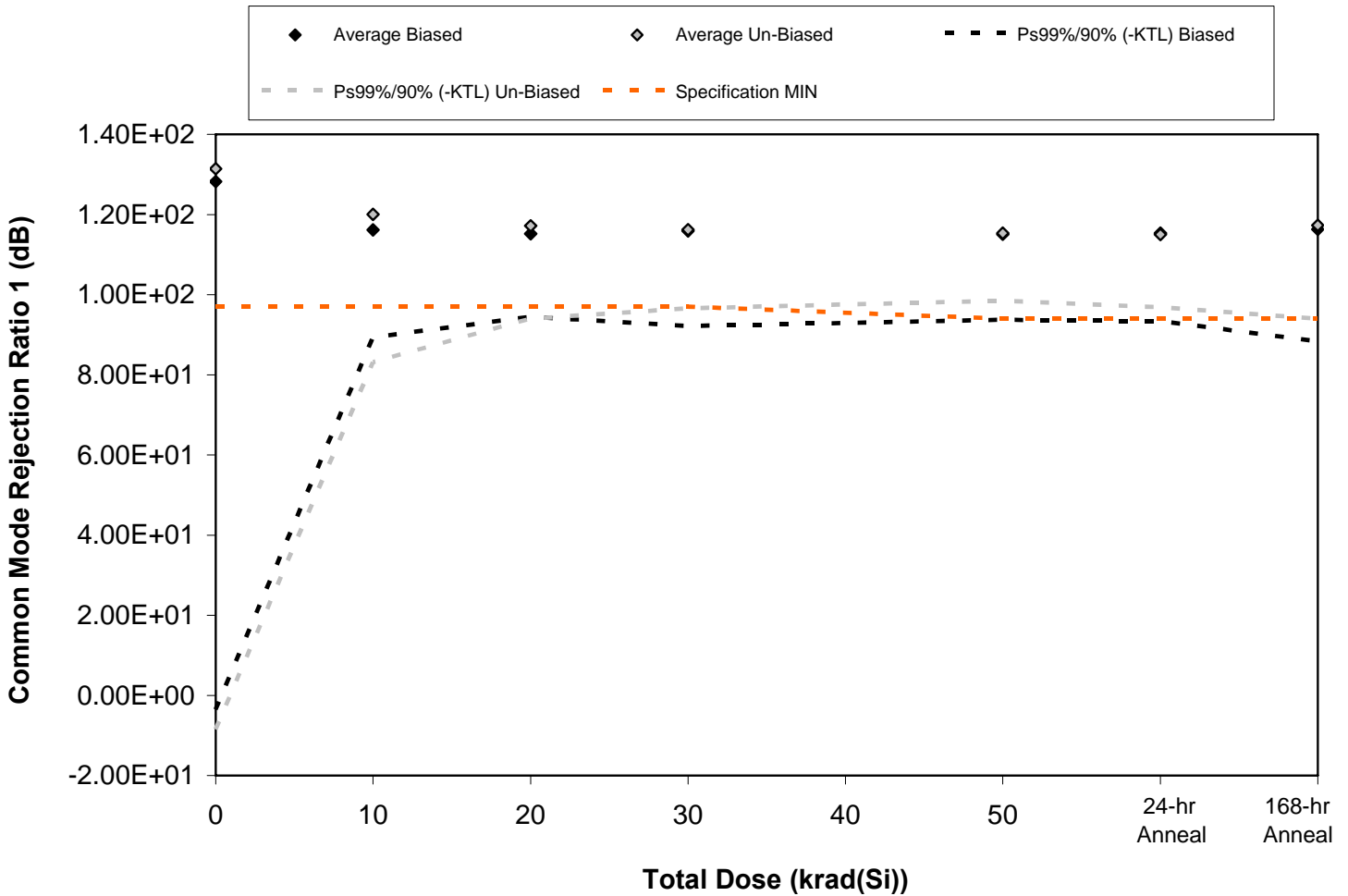

Figure 5.19. Plot of Common Mode Rejection Ratio 1 (dB) versus total dose. The data show a significant degradation with radiation, however it is not sufficient for the measured parameter to fall below specification. Note that the testing and statistics used in this figure are based on an “analysis of variables” technique, which relies on small sample sizes to qualify much larger lot sizes (see MIL-HDBK-814, p. 91 for a discussion of statistical treatments). Unfortunately, this parameter is not well suited to this approach due to inherent large variations. If necessary, larger samples sizes could be used to qualify this parameter using an “attributes” approach. The solid diamonds are the average of measured data points from the biased sample (devices irradiated with an electrical bias) while the shaded diamonds are the average from the unbiased sample. The black lines show the effects on the data after application of the biased KTL statistics (solid and dashed lines) while the gray lines show the effects on the data after application of the unbiased KTL statistics (solid and dashed lines). The red dashed lines are the minimum and maximum specification values as defined in the



Table 5.19. Raw data for Common Mode Rejection Ratio 1 (dB) versus total dose, including the statistical analysis, the specification and the status of the testing (pass/fail).

Common Mode Rejection Ratio 1 (dB)	Total Dose (krad(Si))					24-hr Anneal	168-hr Anneal
	0	10	20	30	50		
Device							
1027	1.16E+02	1.13E+02	1.13E+02	1.13E+02	1.12E+02	1.13E+02	1.14E+02
1029	1.13E+02	1.12E+02	1.12E+02	1.12E+02	1.12E+02	1.12E+02	1.12E+02
1030	1.17E+02	1.15E+02	1.15E+02	1.16E+02	1.15E+02	1.14E+02	1.15E+02
1031	1.79E+02	1.26E+02	1.23E+02	1.25E+02	1.23E+02	1.24E+02	1.27E+02
1032	1.16E+02	1.14E+02	1.14E+02	1.13E+02	1.14E+02	1.14E+02	1.14E+02
1033	1.16E+02	1.14E+02	1.13E+02	1.12E+02	1.12E+02	1.12E+02	1.13E+02
1034	1.21E+02	1.19E+02	1.17E+02	1.17E+02	1.16E+02	1.15E+02	1.18E+02
1035	1.17E+02	1.16E+02	1.14E+02	1.14E+02	1.14E+02	1.13E+02	1.15E+02
1036	1.85E+02	1.34E+02	1.26E+02	1.23E+02	1.21E+02	1.21E+02	1.26E+02
1038	1.19E+02	1.17E+02	1.16E+02	1.15E+02	1.14E+02	1.13E+02	1.15E+02
1039	1.24E+02	1.25E+02	1.25E+02	1.26E+02	1.23E+02	1.26E+02	1.24E+02
<b>Biased Statistics</b>							
Average Biased	1.28E+02	1.16E+02	1.15E+02	1.16E+02	1.15E+02	1.15E+02	1.16E+02
Std Dev Biased	2.82E+01	5.73E+00	4.44E+00	5.08E+00	4.58E+00	4.70E+00	5.98E+00
Ps99%/90% (+KTL) Biased	2.60E+02	1.43E+02	1.36E+02	1.40E+02	1.36E+02	1.37E+02	1.44E+02
Ps99%/90% (-KTL) Biased	-3.49E+00	8.94E+01	9.45E+01	9.21E+01	9.37E+01	9.34E+01	8.84E+01
<b>Un-Biased Statistics</b>							
Average Un-Biased	1.31E+02	1.20E+02	1.17E+02	1.16E+02	1.15E+02	1.15E+02	1.17E+02
Std Dev Un-Biased	3.00E+01	7.90E+00	4.97E+00	4.20E+00	3.61E+00	3.87E+00	4.99E+00
Ps99%/90% (+KTL) Un-Biased	2.71E+02	1.57E+02	1.40E+02	1.36E+02	1.32E+02	1.33E+02	1.41E+02
Ps99%/90% (-KTL) Un-Biased	-8.47E+00	8.32E+01	9.40E+01	9.66E+01	9.85E+01	9.69E+01	9.40E+01
<b>Specification MIN</b>	<b>9.70E+01</b>	<b>9.70E+01</b>	<b>9.70E+01</b>	<b>9.70E+01</b>	<b>9.40E+01</b>	<b>9.40E+01</b>	<b>9.40E+01</b>
Status	FAIL	FAIL	FAIL	FAIL	FAIL	FAIL	FAIL

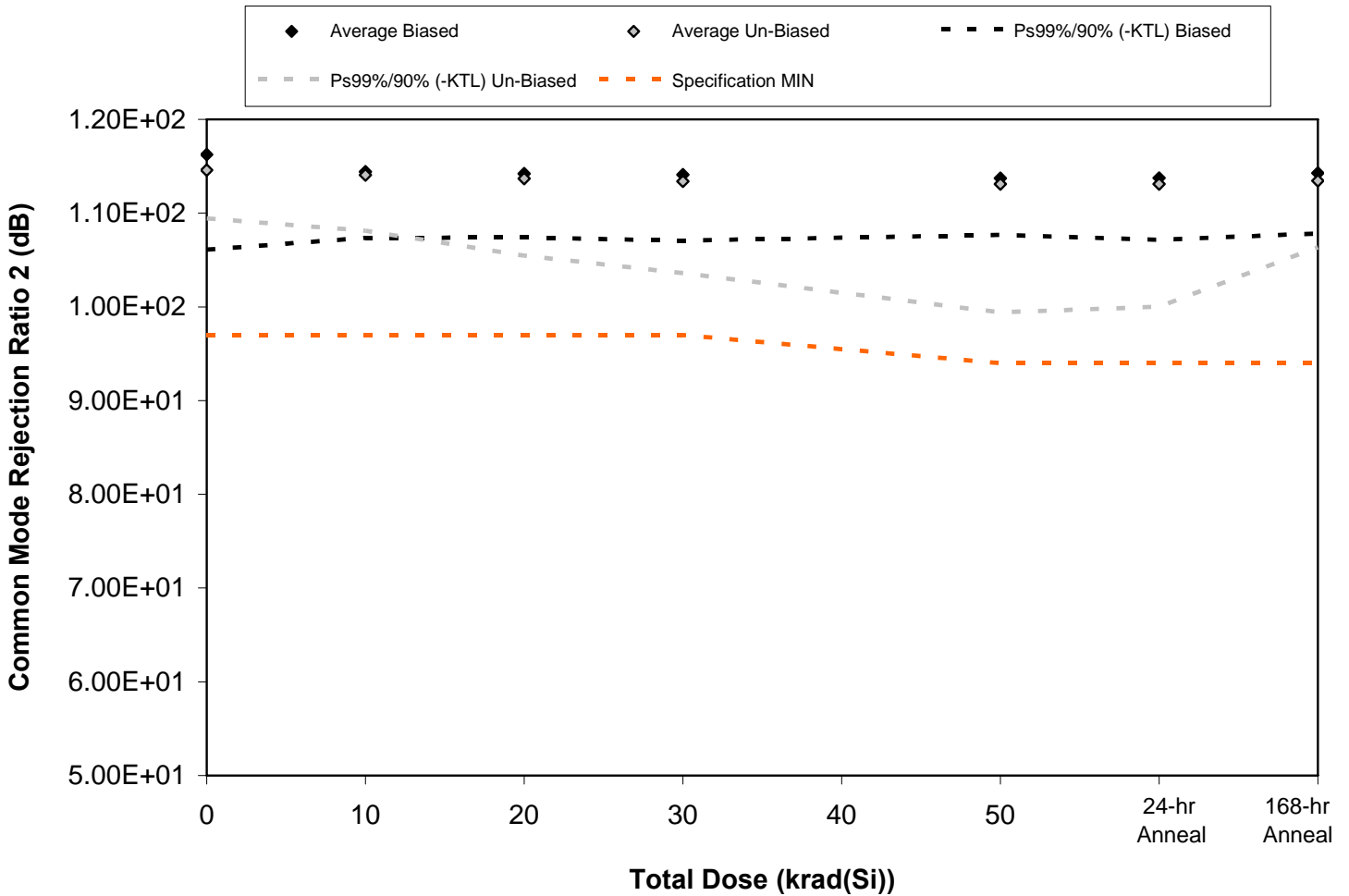

Figure 5.20. Plot of Common Mode Rejection Ratio 2 (dB) versus total dose. The data show no significant degradation with radiation. The solid diamonds are the average of measured data points from the biased sample (devices irradiated with an electrical bias) while the shaded diamonds are the average from the unbiased sample. The black lines show the effects on the data after application of the biased KTL statistics (solid and dashed lines) while the gray lines show the effects on the data after application of the unbiased KTL statistics (solid and dashed lines). The red dashed lines are the minimum and maximum specification values as defined in the datasheet and/or test plan.



Table 5.20. Raw data for Common Mode Rejection Ratio 2 (dB) versus total dose, including the statistical analysis, the specification and the status of the testing (pass/fail).

Common Mode Rejection Ratio 2 (dB)	Total Dose (krad(Si))					24-hr Anneal	168-hr Anneal
	0	10	20	30	50		
Device							
1027	1.15E+02	1.14E+02	1.13E+02	1.14E+02	1.13E+02	1.13E+02	1.14E+02
1029	1.18E+02	1.16E+02	1.16E+02	1.16E+02	1.15E+02	1.15E+02	1.16E+02
1030	1.15E+02	1.14E+02	1.13E+02	1.14E+02	1.13E+02	1.13E+02	1.14E+02
1031	1.14E+02	1.13E+02	1.13E+02	1.12E+02	1.12E+02	1.12E+02	1.12E+02
1032	1.19E+02	1.16E+02	1.16E+02	1.15E+02	1.15E+02	1.15E+02	1.16E+02
1033	1.16E+02	1.15E+02	1.14E+02	1.13E+02	1.13E+02	1.12E+02	1.14E+02
1034	1.14E+02	1.15E+02	1.16E+02	1.17E+02	1.18E+02	1.18E+02	1.16E+02
1035	1.15E+02	1.14E+02	1.14E+02	1.13E+02	1.12E+02	1.13E+02	1.14E+02
1036	1.13E+02	1.12E+02	1.12E+02	1.11E+02	1.11E+02	1.11E+02	1.12E+02
1038	1.15E+02	1.14E+02	1.13E+02	1.13E+02	1.12E+02	1.12E+02	1.13E+02
1039	1.29E+02	1.32E+02	1.34E+02	1.32E+02	1.32E+02	1.30E+02	1.31E+02
<b>Biased Statistics</b>							
Average Biased	1.16E+02	1.14E+02	1.14E+02	1.14E+02	1.14E+02	1.14E+02	1.14E+02
Std Dev Biased	2.17E+00	1.51E+00	1.46E+00	1.51E+00	1.29E+00	1.41E+00	1.38E+00
Ps99%/90% (+KTL) Biased	1.26E+02	1.21E+02	1.21E+02	1.21E+02	1.20E+02	1.20E+02	1.21E+02
Ps99%/90% (-KTL) Biased	1.06E+02	1.07E+02	1.07E+02	1.07E+02	1.08E+02	1.07E+02	1.08E+02
<b>Un-Biased Statistics</b>							
Average Un-Biased	1.15E+02	1.14E+02	1.14E+02	1.13E+02	1.13E+02	1.13E+02	1.13E+02
Std Dev Un-Biased	1.10E+00	1.27E+00	1.76E+00	2.09E+00	2.93E+00	2.80E+00	1.53E+00
Ps99%/90% (+KTL) Un-Biased	1.20E+02	1.20E+02	1.22E+02	1.23E+02	1.27E+02	1.26E+02	1.21E+02
Ps99%/90% (-KTL) Un-Biased	1.09E+02	1.08E+02	1.05E+02	1.04E+02	9.94E+01	1.00E+02	1.06E+02
<b>Specification MIN</b>	<b>9.70E+01</b>	<b>9.70E+01</b>	<b>9.70E+01</b>	<b>9.70E+01</b>	<b>9.40E+01</b>	<b>9.40E+01</b>	<b>9.40E+01</b>
Status	PASS	PASS	PASS	PASS	PASS	PASS	PASS

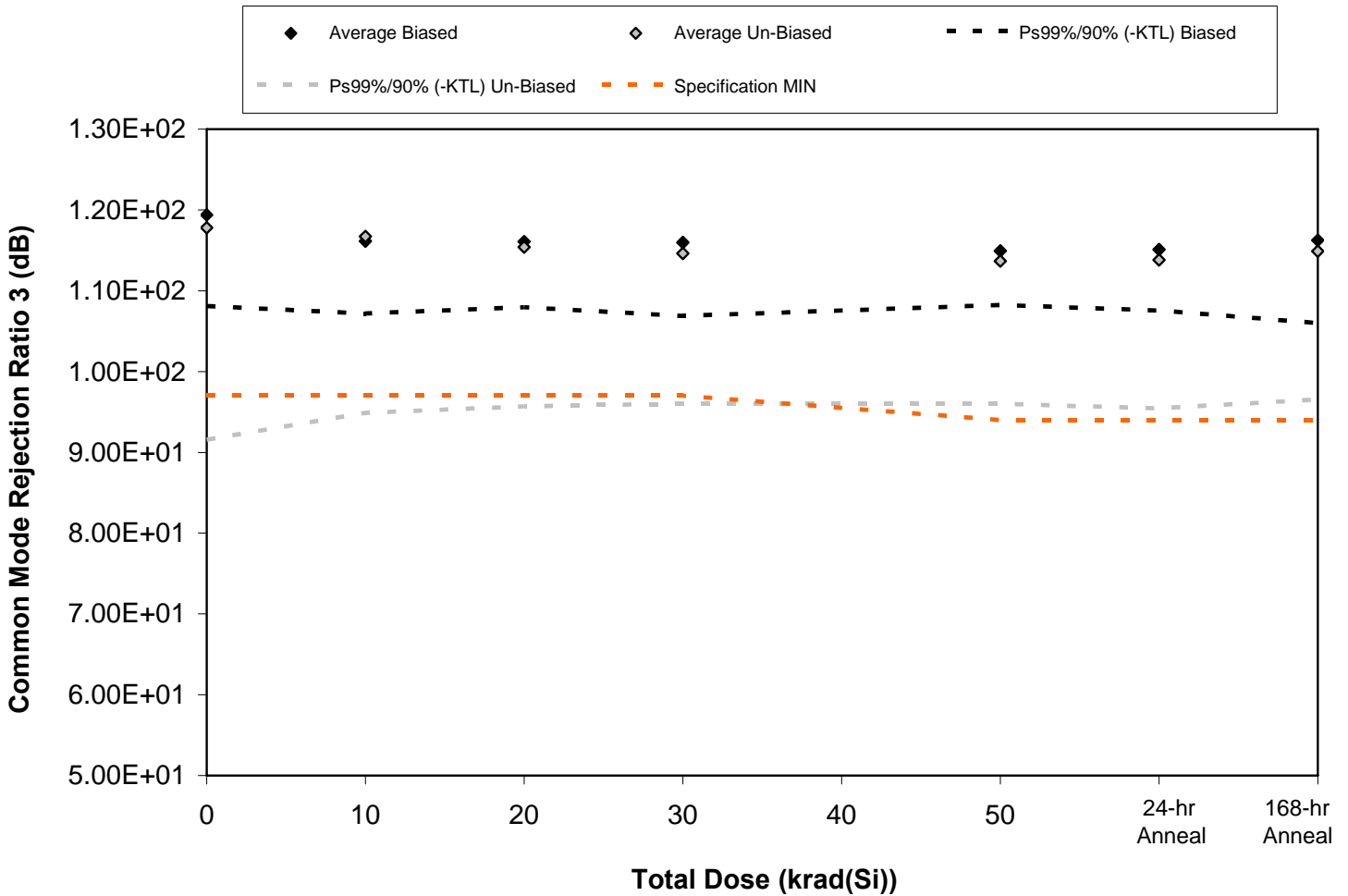

Figure 5.21. Plot of Common Mode Rejection Ratio 3 (dB) versus total dose. The data show some degradation with radiation, however it is not sufficient for the measured parameter to fall below specification. Note that the testing and statistics used in this figure are based on an “analysis of variables” technique, which relies on small sample sizes to qualify much larger lot sizes (see MIL-HDBK-814, p. 91 for a discussion of statistical treatments). Unfortunately, this parameter is not well suited to this approach due to inherent large variations. If necessary, larger samples sizes could be used to qualify this parameter using an “attributes” approach. The solid diamonds are the average of measured data points from the biased sample (devices irradiated with an electrical bias) while the shaded diamonds are the average from the unbiased sample. The black lines show the effects on the data after application of the biased KTL statistics (solid and dashed lines) while the gray lines show the effects on the data after application of the unbiased KTL statistics (solid and dashed lines). The red dashed lines are the minimum and maximum specification values as defined in the





Table 5.21. Raw data for Common Mode Rejection Ratio 3 (dB) versus total dose, including the statistical analysis, the specification and the status of the testing (pass/fail).

Common Mode Rejection Ratio 3 (dB)	Total Dose (krad(Si))					24-hr Anneal	168-hr Anneal
	0	10	20	30	50		
Device							
1027	1.19E+02	1.15E+02	1.15E+02	1.14E+02	1.15E+02	1.15E+02	1.15E+02
1029	1.23E+02	1.18E+02	1.18E+02	1.18E+02	1.17E+02	1.17E+02	1.19E+02
1030	1.17E+02	1.14E+02	1.14E+02	1.14E+02	1.14E+02	1.14E+02	1.13E+02
1031	1.17E+02	1.15E+02	1.15E+02	1.15E+02	1.13E+02	1.13E+02	1.16E+02
1032	1.21E+02	1.18E+02	1.17E+02	1.18E+02	1.16E+02	1.17E+02	1.18E+02
1033	1.12E+02	1.11E+02	1.11E+02	1.10E+02	1.10E+02	1.09E+02	1.10E+02
1034	1.22E+02	1.21E+02	1.19E+02	1.18E+02	1.18E+02	1.18E+02	1.18E+02
1035	1.25E+02	1.22E+02	1.20E+02	1.19E+02	1.17E+02	1.18E+02	1.19E+02
1036	1.18E+02	1.17E+02	1.16E+02	1.15E+02	1.14E+02	1.14E+02	1.15E+02
1038	1.13E+02	1.13E+02	1.12E+02	1.11E+02	1.10E+02	1.11E+02	1.11E+02
1039	1.18E+02	1.18E+02	1.17E+02	1.17E+02	1.17E+02	1.17E+02	1.18E+02
<b>Biased Statistics</b>							
Average Biased	1.19E+02	1.16E+02	1.16E+02	1.16E+02	1.15E+02	1.15E+02	1.16E+02
Std Dev Biased	2.42E+00	1.92E+00	1.74E+00	1.95E+00	1.43E+00	1.62E+00	2.20E+00
Ps99%/90% (+KTL) Biased	1.31E+02	1.25E+02	1.24E+02	1.25E+02	1.22E+02	1.23E+02	1.27E+02
Ps99%/90% (-KTL) Biased	1.08E+02	1.07E+02	1.08E+02	1.07E+02	1.08E+02	1.08E+02	1.06E+02
<b>Un-Biased Statistics</b>							
Average Un-Biased	1.18E+02	1.17E+02	1.15E+02	1.15E+02	1.14E+02	1.14E+02	1.15E+02
Std Dev Un-Biased	5.62E+00	4.68E+00	4.23E+00	3.98E+00	3.79E+00	3.93E+00	3.93E+00
Ps99%/90% (+KTL) Un-Biased	1.44E+02	1.39E+02	1.35E+02	1.33E+02	1.31E+02	1.32E+02	1.33E+02
Ps99%/90% (-KTL) Un-Biased	9.16E+01	9.49E+01	9.57E+01	9.60E+01	9.60E+01	9.55E+01	9.65E+01
<b>Specification MIN</b>	<b>9.70E+01</b>	<b>9.70E+01</b>	<b>9.70E+01</b>	<b>9.70E+01</b>	<b>9.40E+01</b>	<b>9.40E+01</b>	<b>9.40E+01</b>
Status	FAIL	FAIL	FAIL	FAIL	PASS	PASS	PASS

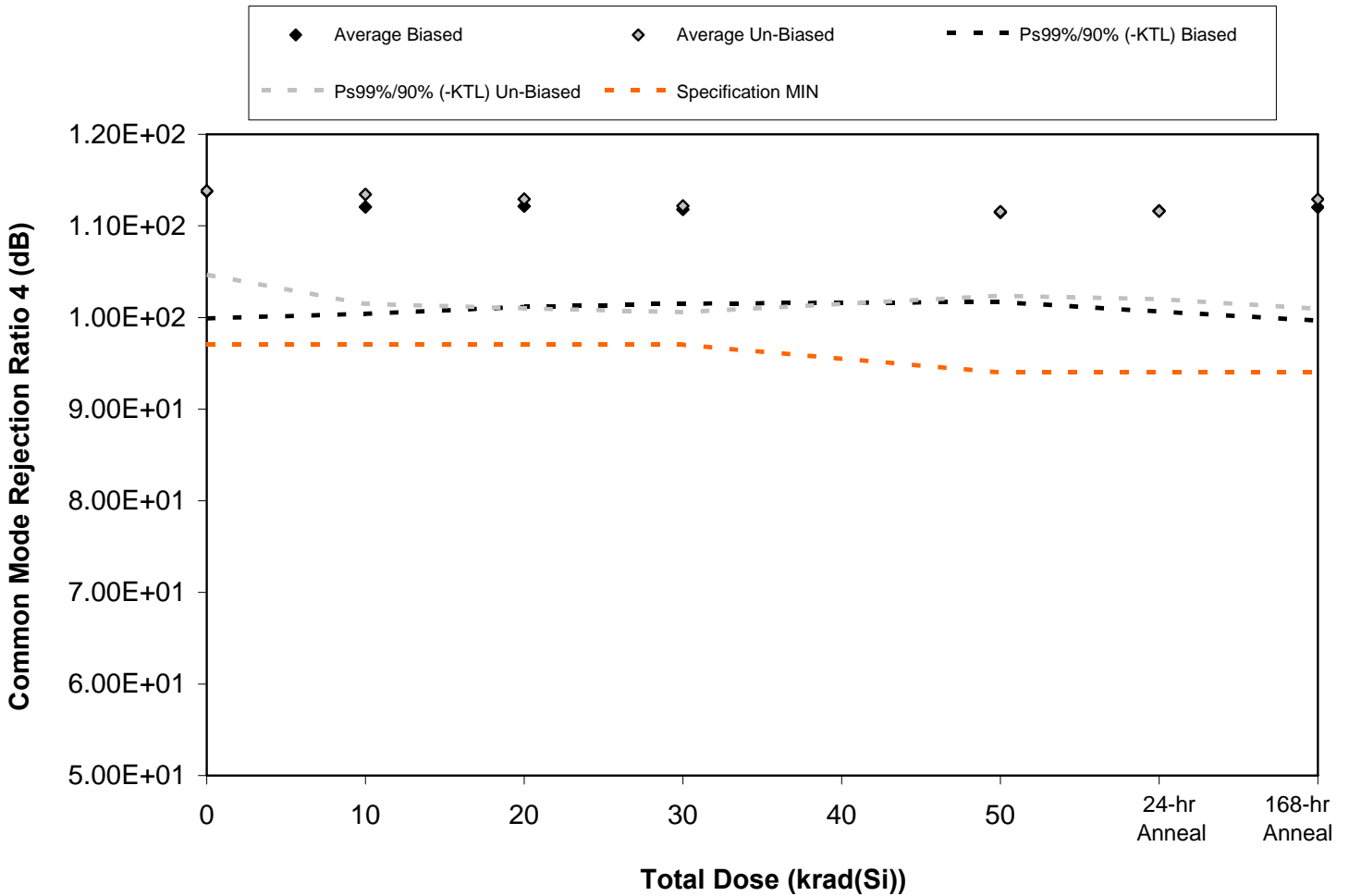

Figure 5.22. Plot of Common Mode Rejection Ratio 4 (dB) versus total dose. The data show no significant degradation with radiation. The solid diamonds are the average of measured data points from the biased sample (devices irradiated with an electrical bias) while the shaded diamonds are the average from the unbiased sample. The black lines show the effects on the data after application of the biased KTL statistics (solid and dashed lines) while the gray lines show the effects on the data after application of the unbiased KTL statistics (solid and dashed lines). The red dashed lines are the minimum and maximum specification values as defined in the datasheet and/or test plan.



Table 5.22. Raw data for Common Mode Rejection Ratio 4 (dB) versus total dose, including the statistical analysis, the specification and the status of the testing (pass/fail).

Common Mode Rejection Ratio 4 (dB)	Total Dose (krad(Si))					24-hr Anneal	168-hr Anneal
	0	10	20	30	50		
Device							
1027	1.11E+02	1.10E+02	1.10E+02	1.10E+02	1.10E+02	1.10E+02	1.10E+02
1029	1.12E+02	1.11E+02	1.12E+02	1.11E+02	1.11E+02	1.11E+02	1.11E+02
1030	1.11E+02	1.10E+02	1.10E+02	1.10E+02	1.10E+02	1.10E+02	1.10E+02
1031	1.18E+02	1.15E+02	1.15E+02	1.15E+02	1.14E+02	1.15E+02	1.16E+02
1032	1.16E+02	1.14E+02	1.14E+02	1.14E+02	1.13E+02	1.13E+02	1.14E+02
1033	1.12E+02	1.11E+02	1.10E+02	1.10E+02	1.10E+02	1.09E+02	1.10E+02
1034	1.12E+02	1.11E+02	1.11E+02	1.10E+02	1.10E+02	1.10E+02	1.11E+02
1035	1.14E+02	1.13E+02	1.12E+02	1.11E+02	1.10E+02	1.11E+02	1.12E+02
1036	1.17E+02	1.17E+02	1.16E+02	1.16E+02	1.14E+02	1.14E+02	1.16E+02
1038	1.15E+02	1.15E+02	1.15E+02	1.14E+02	1.13E+02	1.14E+02	1.15E+02
1039	1.23E+02	1.23E+02	1.22E+02	1.23E+02	1.21E+02	1.22E+02	1.23E+02
<b>Biased Statistics</b>							
Average Biased	1.14E+02	1.12E+02	1.12E+02	1.12E+02	1.11E+02	1.12E+02	1.12E+02
Std Dev Biased	2.97E+00	2.50E+00	2.36E+00	2.20E+00	2.10E+00	2.36E+00	2.65E+00
Ps99%/90% (+KTL) Biased	1.28E+02	1.24E+02	1.23E+02	1.22E+02	1.21E+02	1.23E+02	1.24E+02
Ps99%/90% (-KTL) Biased	9.99E+01	1.00E+02	1.01E+02	1.02E+02	1.02E+02	1.01E+02	9.97E+01
<b>Un-Biased Statistics</b>							
Average Un-Biased	1.14E+02	1.13E+02	1.13E+02	1.12E+02	1.12E+02	1.12E+02	1.13E+02
Std Dev Un-Biased	1.96E+00	2.56E+00	2.55E+00	2.48E+00	1.97E+00	2.06E+00	2.56E+00
Ps99%/90% (+KTL) Un-Biased	1.23E+02	1.25E+02	1.25E+02	1.24E+02	1.21E+02	1.21E+02	1.25E+02
Ps99%/90% (-KTL) Un-Biased	1.05E+02	1.01E+02	1.01E+02	1.01E+02	1.02E+02	1.02E+02	1.01E+02
<b>Specification MIN</b>	<b>9.70E+01</b>	<b>9.70E+01</b>	<b>9.70E+01</b>	<b>9.70E+01</b>	<b>9.40E+01</b>	<b>9.40E+01</b>	<b>9.40E+01</b>
Status	PASS	PASS	PASS	PASS	PASS	PASS	PASS

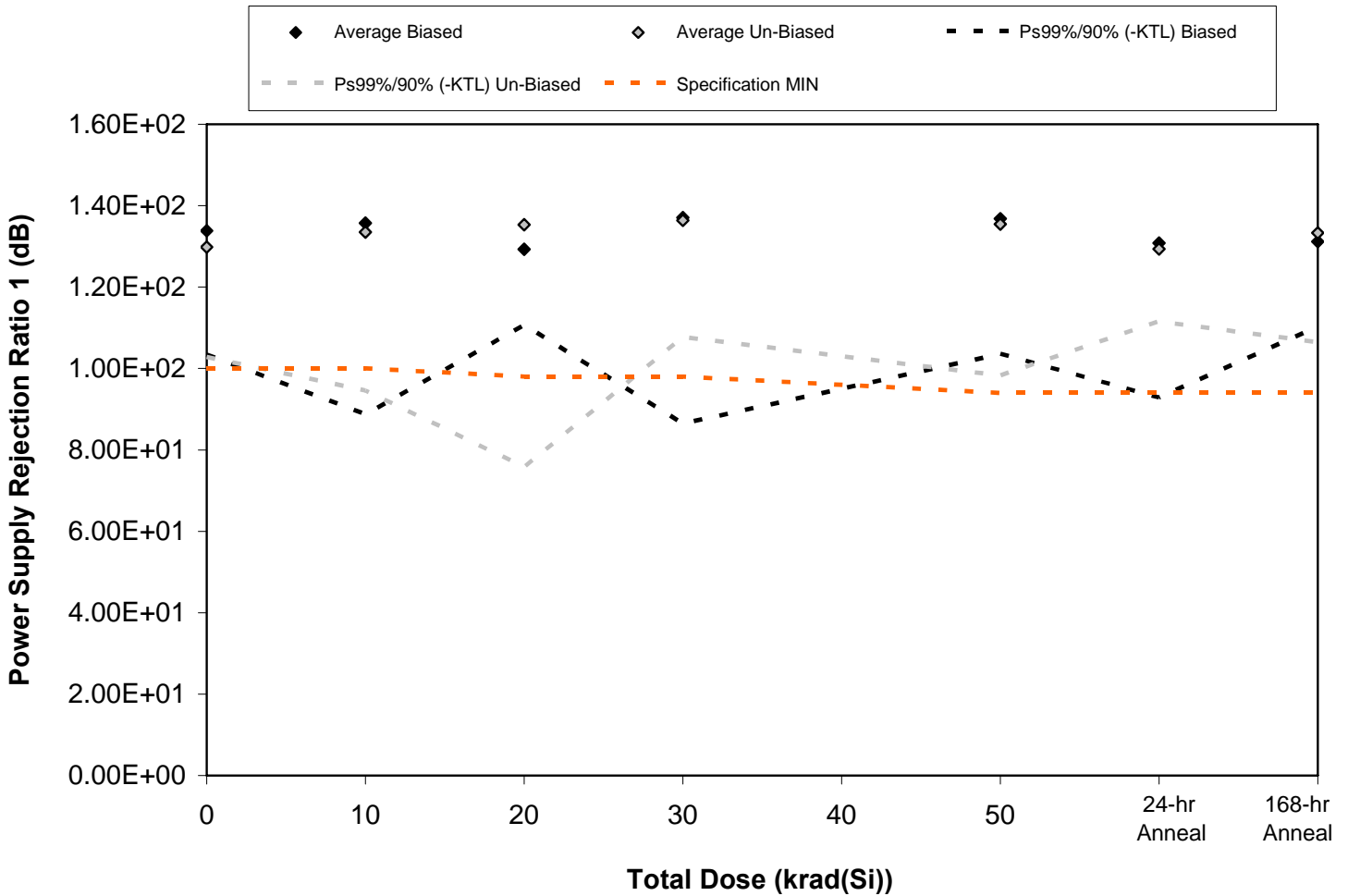

Figure 5.23. Plot of Power Supply Rejection Ratio 1 (dB) versus total dose. The data show no significant degradation with radiation. Note that the testing and statistics used in this figure are based on an “analysis of variables” technique, which relies on small sample sizes to qualify much larger lot sizes (see MIL-HDBK-814, p. 91 for a discussion of statistical treatments). Unfortunately, this parameter is not well suited to this approach due to inherent large variations. If necessary, larger samples sizes could be used to qualify this parameter using an “attributes” approach. The solid diamonds are the average of measured data points from the biased sample (devices irradiated with an electrical bias) while the shaded diamonds are the average from the unbiased sample. The black lines show the effects on the data after application of the biased KTL statistics (solid and dashed lines) while the gray lines show the effects on the data after application of the unbiased KTL statistics (solid and dashed lines). The red dashed lines are the minimum and maximum specification values as defined in the datasheet and/or test plan.



Table 5.23. Raw data for Power Supply Rejection Ratio 1 (dB) versus total dose, including the statistical analysis, the specification and the status of the testing (pass/fail).

Power Supply Rejection Ratio 1 (dB)	Total Dose (krad(Si))					24-hr Anneal	168-hr Anneal
	0	10	20	30	50		
Device							
1027	1.33E+02	1.53E+02	1.28E+02	1.56E+02	1.33E+02	1.26E+02	1.27E+02
1029	1.29E+02	1.30E+02	1.30E+02	1.31E+02	1.36E+02	1.26E+02	1.32E+02
1030	1.29E+02	1.28E+02	1.24E+02	1.32E+02	1.28E+02	1.24E+02	1.27E+02
1031	1.33E+02	1.36E+02	1.34E+02	1.33E+02	1.41E+02	1.37E+02	1.37E+02
1032	1.45E+02	1.32E+02	1.32E+02	1.33E+02	1.46E+02	1.42E+02	1.33E+02
1033	1.31E+02	1.46E+02	1.36E+02	1.39E+02	1.40E+02	1.34E+02	1.30E+02
1034	1.26E+02	1.31E+02	1.28E+02	1.39E+02	1.27E+02	1.28E+02	1.35E+02
1035	1.26E+02	1.27E+02	1.23E+02	1.27E+02	1.28E+02	1.25E+02	1.28E+02
1036	1.27E+02	1.26E+02	1.33E+02	1.43E+02	1.38E+02	1.32E+02	1.31E+02
1038	1.39E+02	1.38E+02	1.57E+02	1.33E+02	1.45E+02	1.27E+02	1.43E+02
1039	1.32E+02	1.38E+02	1.26E+02	1.31E+02	1.33E+02	1.26E+02	1.31E+02
<b>Biased Statistics</b>							
Average Biased	1.34E+02	1.36E+02	1.29E+02	1.37E+02	1.37E+02	1.31E+02	1.31E+02
Std Dev Biased	6.52E+00	1.01E+01	3.99E+00	1.08E+01	7.12E+00	8.14E+00	4.48E+00
Ps99%/90% (+KTL) Biased	1.64E+02	1.83E+02	1.48E+02	1.88E+02	1.70E+02	1.69E+02	1.52E+02
Ps99%/90% (-KTL) Biased	1.03E+02	8.88E+01	1.11E+02	8.65E+01	1.04E+02	9.28E+01	1.10E+02
<b>Un-Biased Statistics</b>							
Average Un-Biased	1.30E+02	1.33E+02	1.35E+02	1.36E+02	1.35E+02	1.29E+02	1.33E+02
Std Dev Un-Biased	5.78E+00	8.33E+00	1.28E+01	6.14E+00	7.97E+00	3.82E+00	5.75E+00
Ps99%/90% (+KTL) Un-Biased	1.57E+02	1.72E+02	1.95E+02	1.65E+02	1.73E+02	1.47E+02	1.60E+02
Ps99%/90% (-KTL) Un-Biased	1.03E+02	9.46E+01	7.58E+01	1.08E+02	9.83E+01	1.12E+02	1.06E+02
<b>Specification MIN</b>	<b>1.00E+02</b>	<b>1.00E+02</b>	<b>9.80E+01</b>	<b>9.80E+01</b>	<b>9.40E+01</b>	<b>9.40E+01</b>	<b>9.40E+01</b>
Status	PASS	FAIL	FAIL	FAIL	PASS	FAIL	PASS

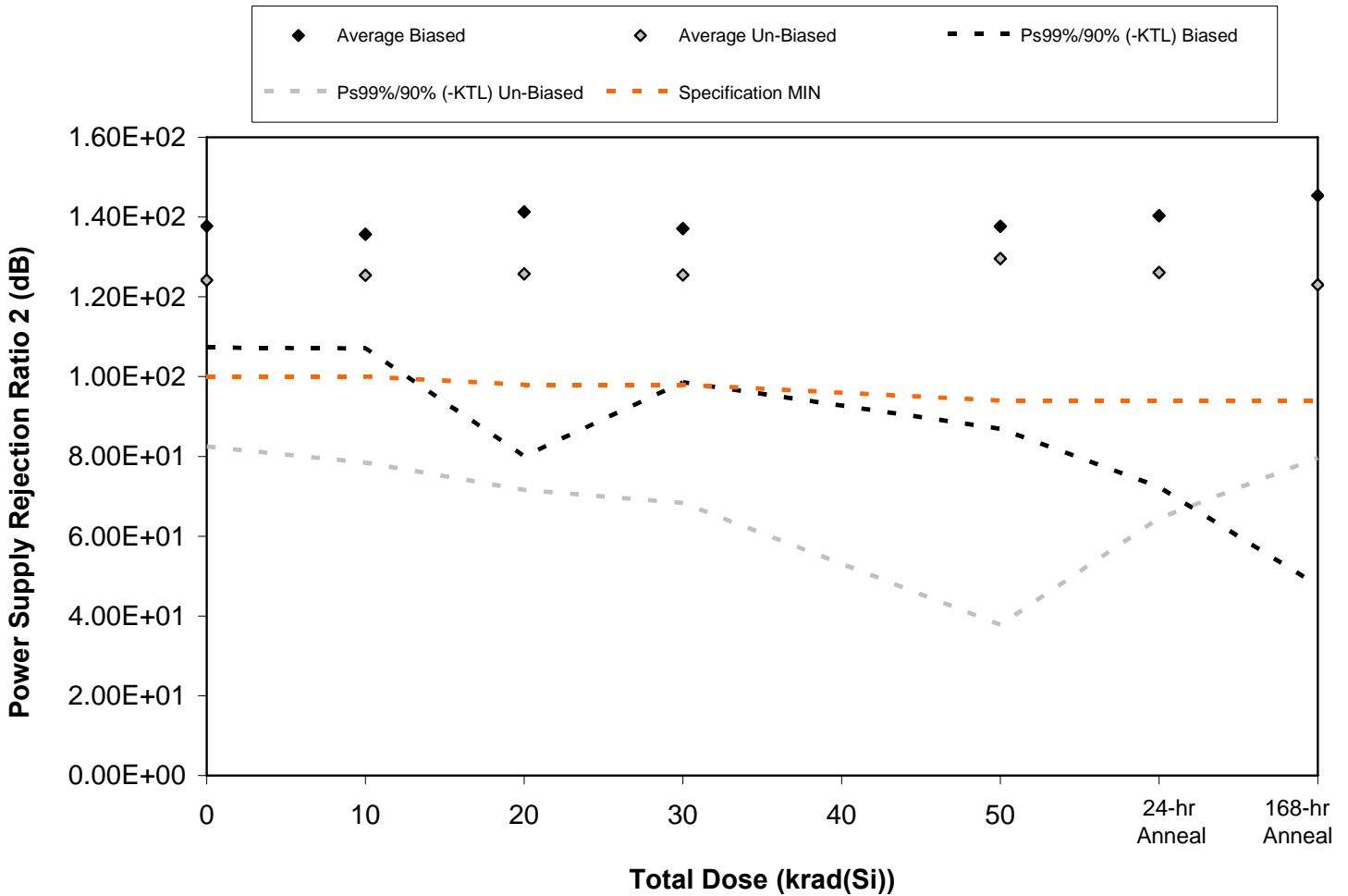

Figure 5.24. Plot of Power Supply Rejection Ratio 2 (dB) versus total dose. The data show no significant degradation with radiation. Note that the testing and statistics used in this figure are based on an “analysis of variables” technique, which relies on small sample sizes to qualify much larger lot sizes (see MIL-HDBK-814, p. 91 for a discussion of statistical treatments). Unfortunately, this parameter is not well suited to this approach due to inherent large variations. If necessary, larger samples sizes could be used to qualify this parameter using an “attributes” approach. The solid diamonds are the average of measured data points from the biased sample (devices irradiated with an electrical bias) while the shaded diamonds are the average from the unbiased sample. The black lines show the effects on the data after application of the biased KTL statistics (solid and dashed lines) while the gray lines show the effects on the data after application of the unbiased KTL statistics (solid and dashed lines). The red dashed lines are the minimum and maximum specification values as defined in the datasheet and/or test plan.



Table 5.24. Raw data for Power Supply Rejection Ratio 2 (dB) versus total dose, including the statistical analysis, the specification and the status of the testing (pass/fail).

Power Supply Rejection Ratio 2 (dB)	Total Dose (krad(Si))					24-hr Anneal	168-hr Anneal
	0	10	20	30	50		
Device							
1027	1.34E+02	1.33E+02	1.40E+02	1.34E+02	1.33E+02	1.35E+02	1.38E+02
1029	1.33E+02	1.30E+02	1.32E+02	1.29E+02	1.28E+02	1.30E+02	1.29E+02
1030	1.36E+02	1.31E+02	1.29E+02	1.31E+02	1.29E+02	1.30E+02	1.33E+02
1031	1.36E+02	1.41E+02	1.43E+02	1.47E+02	1.51E+02	1.65E+02	1.47E+02
1032	1.49E+02	1.44E+02	1.62E+02	1.45E+02	1.47E+02	1.42E+02	1.81E+02
1033	1.27E+02	1.32E+02	1.31E+02	1.31E+02	1.33E+02	1.36E+02	1.29E+02
1034	1.16E+02	1.15E+02	1.14E+02	1.14E+02	1.13E+02	1.13E+02	1.13E+02
1035	1.14E+02	1.14E+02	1.14E+02	1.14E+02	1.14E+02	1.13E+02	1.13E+02
1036	1.33E+02	1.36E+02	1.41E+02	1.43E+02	1.61E+02	1.42E+02	1.34E+02
1038	1.32E+02	1.30E+02	1.29E+02	1.26E+02	1.27E+02	1.25E+02	1.26E+02
1039	1.23E+02	1.23E+02	1.21E+02	1.22E+02	1.23E+02	1.22E+02	1.23E+02
<b>Biased Statistics</b>							
Average Biased	1.38E+02	1.36E+02	1.41E+02	1.37E+02	1.38E+02	1.40E+02	1.45E+02
Std Dev Biased	6.53E+00	6.13E+00	1.31E+01	8.25E+00	1.09E+01	1.46E+01	2.10E+01
Ps99%/90% (+KTL) Biased	1.68E+02	1.64E+02	2.03E+02	1.76E+02	1.88E+02	2.08E+02	2.43E+02
Ps99%/90% (-KTL) Biased	1.07E+02	1.07E+02	8.01E+01	9.86E+01	8.70E+01	7.23E+01	4.76E+01
<b>Un-Biased Statistics</b>							
Average Un-Biased	1.24E+02	1.25E+02	1.26E+02	1.25E+02	1.30E+02	1.26E+02	1.23E+02
Std Dev Un-Biased	8.94E+00	1.01E+01	1.16E+01	1.23E+01	1.97E+01	1.32E+01	9.32E+00
Ps99%/90% (+KTL) Un-Biased	1.66E+02	1.72E+02	1.80E+02	1.83E+02	2.21E+02	1.88E+02	1.67E+02
Ps99%/90% (-KTL) Un-Biased	8.25E+01	7.84E+01	7.16E+01	6.83E+01	3.78E+01	6.45E+01	7.96E+01
<b>Specification MIN</b>	<b>1.00E+02</b>	<b>1.00E+02</b>	<b>9.80E+01</b>	<b>9.80E+01</b>	<b>9.40E+01</b>	<b>9.40E+01</b>	<b>9.40E+01</b>
Status	FAIL	FAIL	FAIL	FAIL	FAIL	FAIL	FAIL

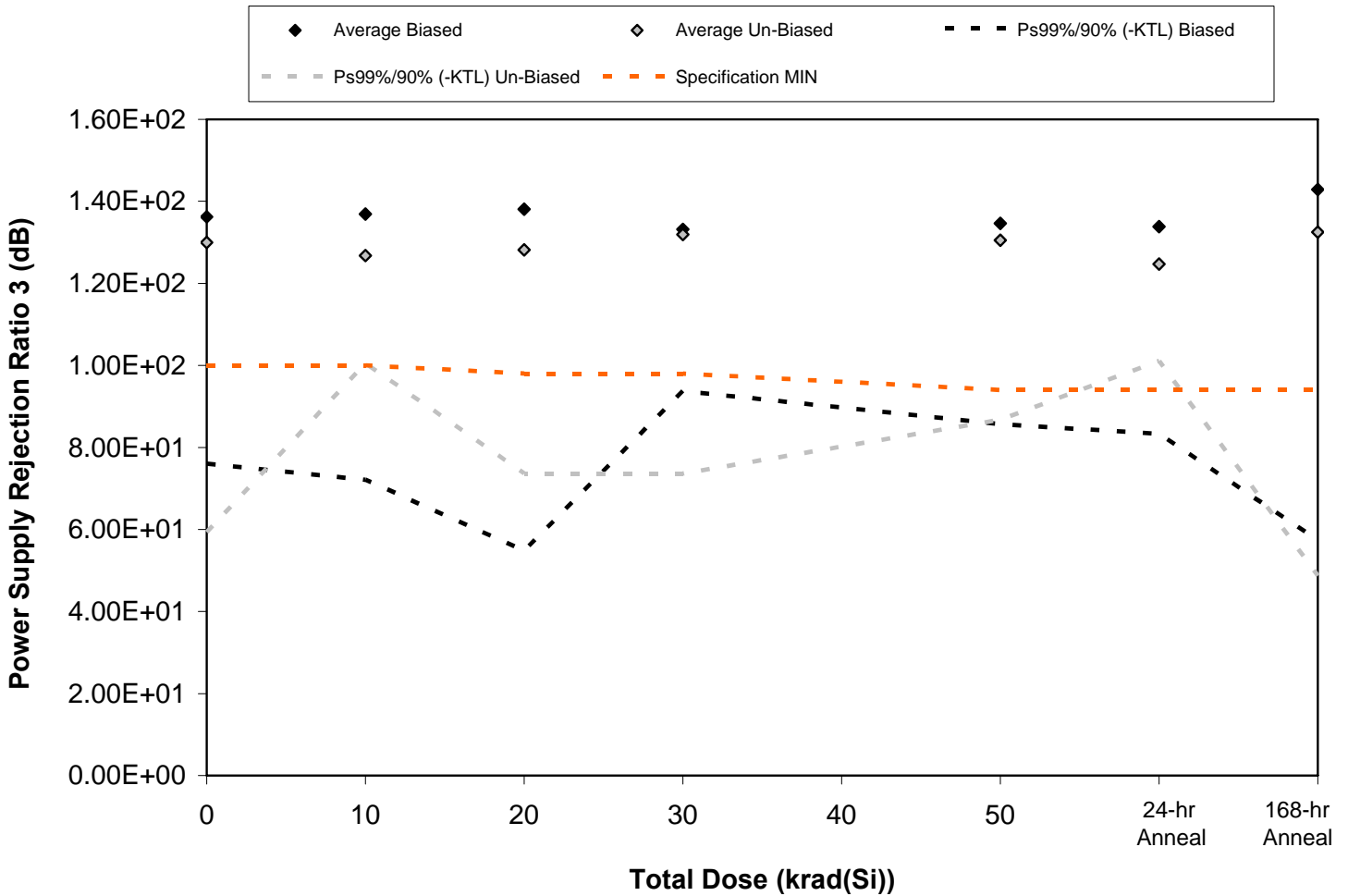

Figure 5.25. Plot of Power Supply Rejection Ratio 3 (dB) versus total dose. The data show no significant degradation with radiation. Note that the testing and statistics used in this figure are based on an “analysis of variables” technique, which relies on small sample sizes to qualify much larger lot sizes (see MIL-HDBK-814, p. 91 for a discussion of statistical treatments). Unfortunately, this parameter is not well suited to this approach due to inherent large variations. If necessary, larger samples sizes could be used to qualify this parameter using an “attributes” approach. The solid diamonds are the average of measured data points from the biased sample (devices irradiated with an electrical bias) while the shaded diamonds are the average from the unbiased sample. The black lines show the effects on the data after application of the biased KTL statistics (solid and dashed lines) while the gray lines show the effects on the data after application of the unbiased KTL statistics (solid and dashed lines). The red dashed lines are the minimum and maximum specification values as defined in the datasheet and/or test plan.





Table 5.25. Raw data for Power Supply Rejection Ratio 3 (dB) versus total dose, including the statistical analysis, the specification and the status of the testing (pass/fail).

Power Supply Rejection Ratio 3 (dB)	Total Dose (krad(Si))					24-hr Anneal	168-hr Anneal
	0	10	20	30	50		
Device							
1027	1.38E+02	1.40E+02	1.31E+02	1.41E+02	1.38E+02	1.36E+02	1.35E+02
1029	1.42E+02	1.39E+02	1.44E+02	1.38E+02	1.41E+02	1.43E+02	1.43E+02
1030	1.20E+02	1.19E+02	1.17E+02	1.20E+02	1.17E+02	1.17E+02	1.19E+02
1031	1.28E+02	1.30E+02	1.65E+02	1.37E+02	1.33E+02	1.30E+02	1.69E+02
1032	1.54E+02	1.57E+02	1.34E+02	1.31E+02	1.44E+02	1.44E+02	1.48E+02
1033	1.55E+02	1.28E+02	1.31E+02	1.31E+02	1.42E+02	1.26E+02	1.62E+02
1034	1.17E+02	1.20E+02	1.17E+02	1.19E+02	1.17E+02	1.17E+02	1.18E+02
1035	1.25E+02	1.26E+02	1.20E+02	1.27E+02	1.27E+02	1.23E+02	1.23E+02
1036	1.22E+02	1.24E+02	1.26E+02	1.30E+02	1.32E+02	1.28E+02	1.23E+02
1038	1.31E+02	1.35E+02	1.47E+02	1.52E+02	1.34E+02	1.30E+02	1.38E+02
1039	1.35E+02	1.55E+02	1.30E+02	1.39E+02	1.39E+02	1.36E+02	1.44E+02
<b>Biased Statistics</b>							
Average Biased	1.36E+02	1.37E+02	1.38E+02	1.33E+02	1.35E+02	1.34E+02	1.43E+02
Std Dev Biased	1.29E+01	1.39E+01	1.78E+01	8.45E+00	1.05E+01	1.08E+01	1.83E+01
Ps99%/90% (+KTL) Biased	1.96E+02	2.02E+02	2.21E+02	1.73E+02	1.84E+02	1.84E+02	2.28E+02
Ps99%/90% (-KTL) Biased	7.61E+01	7.21E+01	5.48E+01	9.38E+01	8.57E+01	8.33E+01	5.73E+01
<b>Un-Biased Statistics</b>							
Average Un-Biased	1.30E+02	1.27E+02	1.28E+02	1.32E+02	1.31E+02	1.25E+02	1.32E+02
Std Dev Un-Biased	1.51E+01	5.64E+00	1.17E+01	1.25E+01	9.38E+00	5.07E+00	1.80E+01
Ps99%/90% (+KTL) Un-Biased	2.01E+02	1.53E+02	1.83E+02	1.90E+02	1.74E+02	1.48E+02	2.16E+02
Ps99%/90% (-KTL) Un-Biased	5.93E+01	1.00E+02	7.37E+01	7.36E+01	8.68E+01	1.01E+02	4.87E+01
<b>Specification MIN</b>	<b>1.00E+02</b>	<b>1.00E+02</b>	<b>9.80E+01</b>	<b>9.80E+01</b>	<b>9.40E+01</b>	<b>9.40E+01</b>	<b>9.40E+01</b>
Status	FAIL	FAIL	FAIL	FAIL	FAIL	FAIL	FAIL

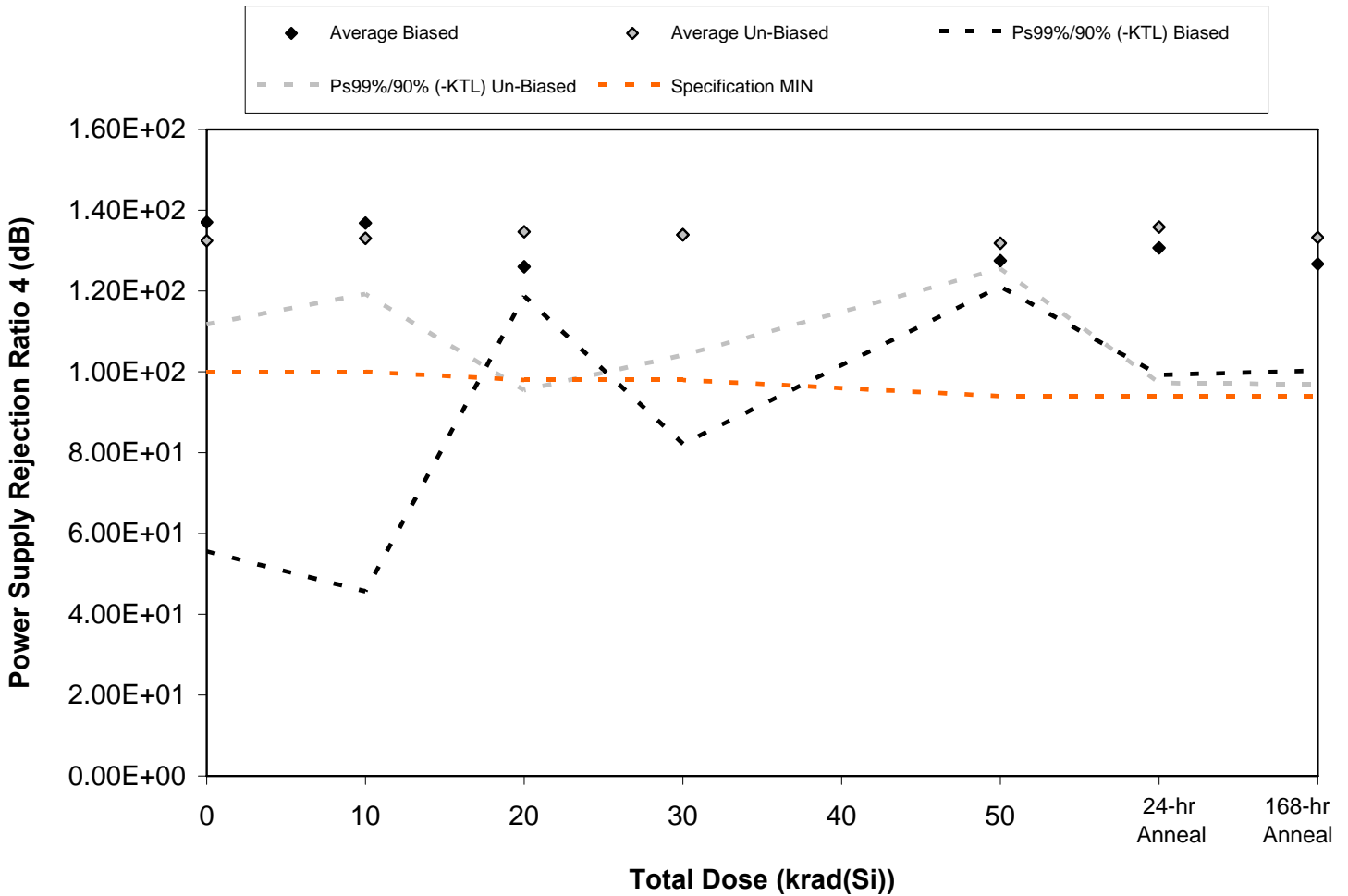

Figure 5.26. Plot of Power Supply Rejection Ratio 4 (dB) versus total dose. The data show no significant degradation with radiation. Note that the testing and statistics used in this figure are based on an “analysis of variables” technique, which relies on small sample sizes to qualify much larger lot sizes (see MIL-HDBK-814, p. 91 for a discussion of statistical treatments). Unfortunately, this parameter is not well suited to this approach due to inherent large variations. If necessary, larger samples sizes could be used to qualify this parameter using an “attributes” approach. The solid diamonds are the average of measured data points from the biased sample (devices irradiated with an electrical bias) while the shaded diamonds are the average from the unbiased sample. The black lines show the effects on the data after application of the biased KTL statistics (solid and dashed lines) while the gray lines show the effects on the data after application of the unbiased KTL statistics (solid and dashed lines). The red dashed lines are the minimum and maximum specification values as defined in the datasheet and/or test plan.



Table 5.26. Raw data for Power Supply Rejection Ratio 4 (dB) versus total dose, including the statistical analysis, the specification and the status of the testing (pass/fail).

Power Supply Rejection Ratio 4 (dB)	Total Dose (krad(Si))					24-hr Anneal	168-hr Anneal
	0	10	20	30	50		
Device							
1027	1.23E+02	1.32E+02	1.25E+02	1.31E+02	1.29E+02	1.23E+02	1.22E+02
1029	1.25E+02	1.25E+02	1.26E+02	1.28E+02	1.26E+02	1.25E+02	1.22E+02
1030	1.66E+02	1.30E+02	1.28E+02	1.54E+02	1.28E+02	1.36E+02	1.36E+02
1031	1.41E+02	1.71E+02	1.28E+02	1.30E+02	1.29E+02	1.38E+02	1.28E+02
1032	1.30E+02	1.26E+02	1.24E+02	1.27E+02	1.26E+02	1.31E+02	1.25E+02
1033	1.26E+02	1.33E+02	1.28E+02	1.31E+02	1.30E+02	1.44E+02	1.24E+02
1034	1.31E+02	1.35E+02	1.36E+02	1.45E+02	1.33E+02	1.31E+02	1.45E+02
1035	1.35E+02	1.37E+02	1.48E+02	1.32E+02	1.32E+02	1.40E+02	1.32E+02
1036	1.34E+02	1.29E+02	1.33E+02	1.34E+02	1.33E+02	1.41E+02	1.33E+02
1038	1.37E+02	1.31E+02	1.28E+02	1.28E+02	1.31E+02	1.24E+02	1.32E+02
1039	1.23E+02	1.25E+02	1.21E+02	1.22E+02	1.25E+02	1.21E+02	1.22E+02
<b>Biased Statistics</b>							
Average Biased	1.37E+02	1.37E+02	1.26E+02	1.34E+02	1.28E+02	1.31E+02	1.27E+02
Std Dev Biased	1.75E+01	1.95E+01	1.56E+00	1.11E+01	1.37E+00	6.72E+00	5.66E+00
Ps99%/90% (+KTL) Biased	2.19E+02	2.28E+02	1.33E+02	1.86E+02	1.34E+02	1.62E+02	1.53E+02
Ps99%/90% (-KTL) Biased	5.55E+01	4.57E+01	1.19E+02	8.21E+01	1.21E+02	9.93E+01	1.00E+02
<b>Un-Biased Statistics</b>							
Average Un-Biased	1.32E+02	1.33E+02	1.35E+02	1.34E+02	1.32E+02	1.36E+02	1.33E+02
Std Dev Un-Biased	4.44E+00	2.96E+00	8.39E+00	6.39E+00	1.37E+00	8.27E+00	7.78E+00
Ps99%/90% (+KTL) Un-Biased	1.53E+02	1.47E+02	1.74E+02	1.64E+02	1.38E+02	1.74E+02	1.70E+02
Ps99%/90% (-KTL) Un-Biased	1.12E+02	1.19E+02	9.55E+01	1.04E+02	1.25E+02	9.72E+01	9.70E+01
<b>Specification MIN</b>	<b>1.00E+02</b>	<b>1.00E+02</b>	<b>9.80E+01</b>	<b>9.80E+01</b>	<b>9.40E+01</b>	<b>9.40E+01</b>	<b>9.40E+01</b>
Status	FAIL	FAIL	FAIL	FAIL	PASS	PASS	PASS

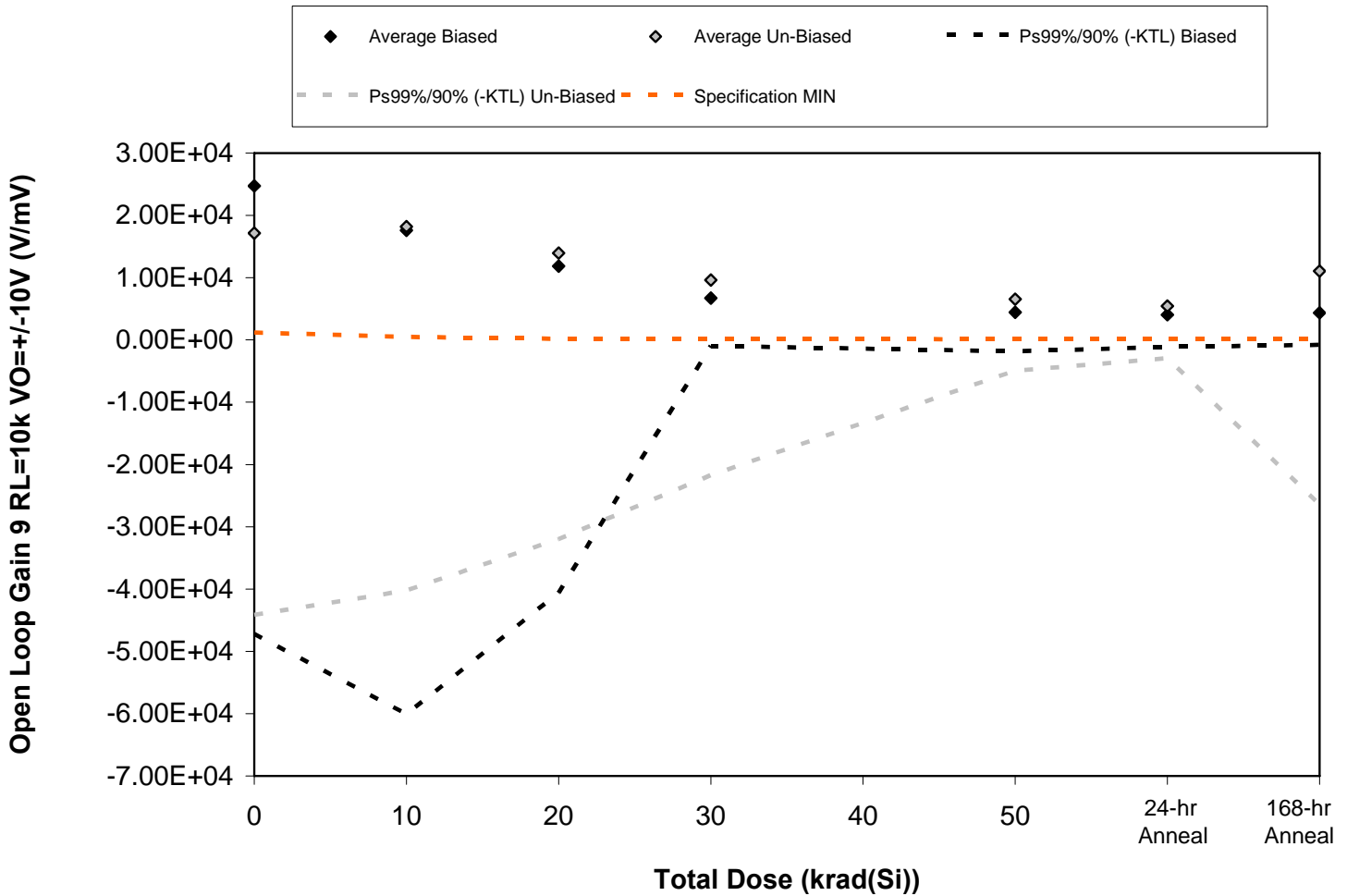

Figure 5.27. Plot of Open Loop Gain 9 RL=10k VO=+/-10V (V/mV) versus total dose. The data show significant degradation with radiation, however not sufficient for the average of the measured data to fall below the specification limit. Note that the testing and statistics used in this figure are based on an “analysis of variables” technique, which relies on small sample sizes to qualify much larger lot sizes (see MIL-HDBK-814, p. 91 for a discussion of statistical treatments). Unfortunately, this parameter is not well suited to this approach due to inherent large variations. If necessary, larger samples sizes could be used to qualify this parameter using an “attributes” approach. The solid diamonds are the average of measured data points from the biased sample (devices irradiated with an electrical bias) while the shaded diamonds are the average from the unbiased sample. The black lines show the effects on the data after application of the biased KTL statistics (solid and dashed lines) while the gray lines show the effects on the data after application of the unbiased KTL statistics (solid and dashed lines). The red dashed lines are the minimum and maximum specification values as



**ELDRS Report  
08-199 090408 R1.2**

**Radiation Assured Devices  
5017 N. 30th Street  
Colorado Springs, CO 80919  
(719) 531-0800**

Table 5.27. Raw data for Open Loop Gain 9 RL=10k VO=+/-10V (V/mV) versus total dose, including the statistical analysis, the specification and the status of the testing (pass/fail).

Open Loop Gain 9 RL=10k VO=+/-10V (V/mV)	Total Dose (krad(Si))					24-hr Anneal	168-hr Anneal
	0	10	20	30	50		
Device							
1027	1.98E+04	1.03E+04	9.69E+03	6.68E+03	4.24E+03	5.08E+03	4.21E+03
1029	1.26E+04	1.27E+04	6.06E+03	8.91E+03	6.23E+03	4.98E+03	6.25E+03
1030	1.52E+04	1.30E+04	5.31E+03	5.62E+03	2.92E+03	2.78E+03	3.45E+03
1031	5.10E+04	4.68E+04	3.17E+04	7.62E+03	5.28E+03	4.49E+03	4.11E+03
1032	2.51E+04	5.05E+03	6.44E+03	4.73E+03	3.46E+03	2.94E+03	3.74E+03
1033	6.29E+03	1.15E+04	5.52E+03	3.72E+03	4.51E+03	3.21E+03	4.67E+03
1034	1.55E+04	4.02E+04	3.08E+04	2.11E+04	9.22E+03	6.42E+03	1.51E+04
1035	1.12E+04	1.16E+04	1.06E+04	6.67E+03	4.07E+03	3.97E+03	5.76E+03
1036	1.29E+04	1.69E+04	9.33E+03	7.74E+03	5.86E+03	7.53E+03	6.36E+03
1038	3.99E+04	1.08E+04	1.35E+04	8.76E+03	9.06E+03	6.11E+03	2.34E+04
1039	1.08E+04	1.76E+04	6.38E+04	2.68E+05	3.23E+04	1.05E+04	3.28E+05
<b>Biased Statistics</b>							
Average Biased	2.47E+04	1.76E+04	1.18E+04	6.71E+03	4.43E+03	4.06E+03	4.35E+03
Std Dev Biased	1.54E+04	1.66E+04	1.12E+04	1.64E+03	1.34E+03	1.11E+03	1.10E+03
Ps99%/90% (+KTL) Biased	9.67E+04	9.52E+04	6.43E+04	1.44E+04	1.07E+04	9.25E+03	9.49E+03
Ps99%/90% (-KTL) Biased	-4.72E+04	-6.01E+04	-4.06E+04	-9.51E+02	-1.84E+03	-1.14E+03	-7.94E+02
<b>Un-Biased Statistics</b>							
Average Un-Biased	1.72E+04	1.82E+04	1.40E+04	9.60E+03	6.54E+03	5.45E+03	1.10E+04
Std Dev Un-Biased	1.31E+04	1.25E+04	9.85E+03	6.72E+03	2.46E+03	1.80E+03	8.04E+03
Ps99%/90% (+KTL) Un-Biased	7.85E+04	7.67E+04	5.99E+04	4.09E+04	1.80E+04	1.38E+04	4.86E+04
Ps99%/90% (-KTL) Un-Biased	-4.41E+04	-4.02E+04	-3.20E+04	-2.17E+04	-4.94E+03	-2.93E+03	-2.65E+04
<b>Specification MIN</b>	<b>1.20E+03</b>	<b>5.00E+02</b>	<b>2.00E+02</b>	<b>2.00E+02</b>	<b>1.00E+02</b>	<b>1.00E+02</b>	<b>1.00E+02</b>
Status	FAIL	FAIL	FAIL	FAIL	FAIL	FAIL	FAIL

**An ISO 9001:2000 Certified Company**

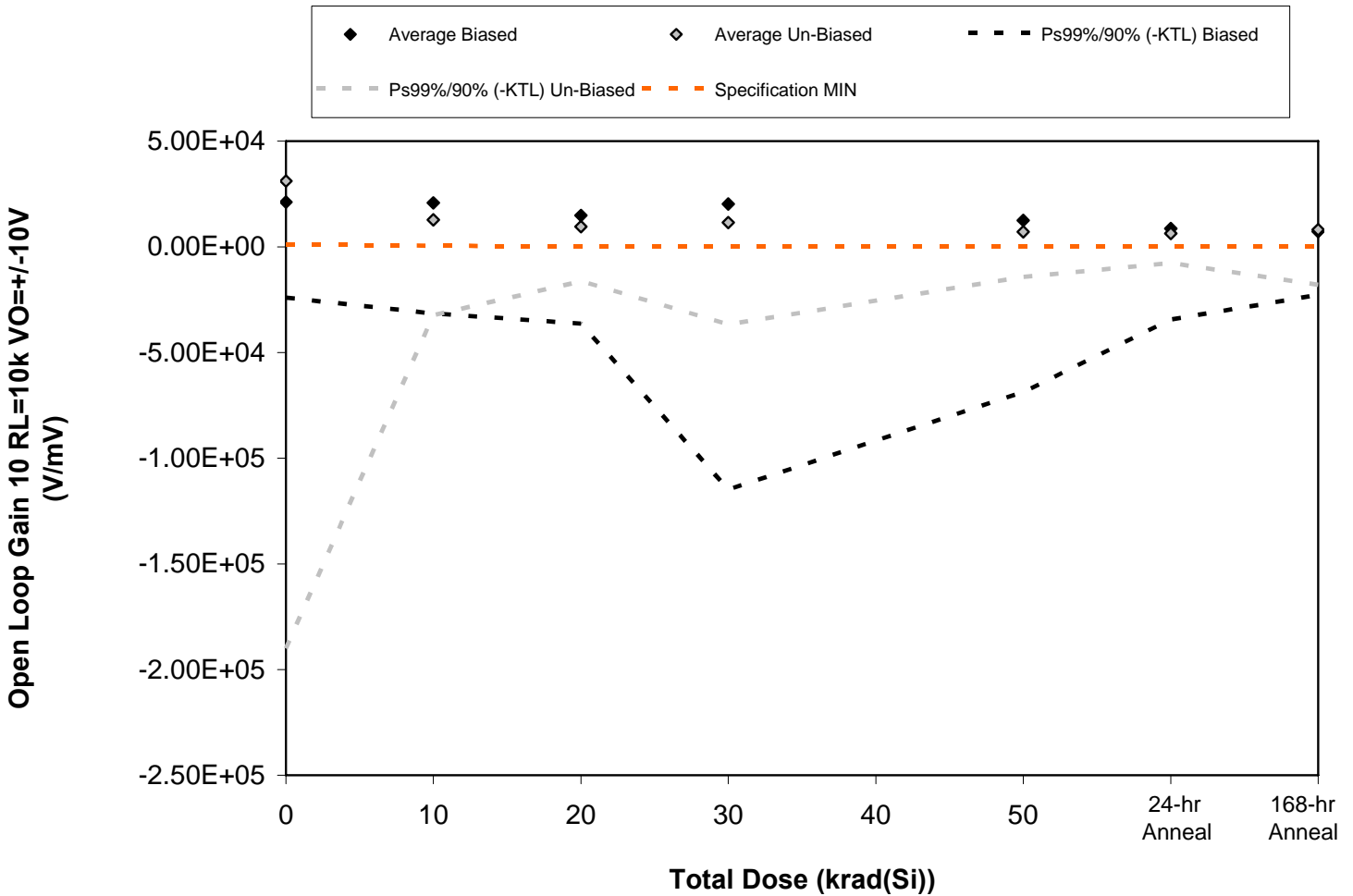

Figure 5.28. Plot of Open Loop Gain 10 RL=10k VO=+/-10V (V/mV) versus total dose. The data show significant degradation with radiation, however not sufficient for the average of the measured data to fall below the specification limit. Note that the testing and statistics used in this figure are based on an “analysis of variables” technique, which relies on small sample sizes to qualify much larger lot sizes (see MIL-HDBK-814, p. 91 for a discussion of statistical treatments). Unfortunately, this parameter is not well suited to this approach due to inherent large variations. If necessary, larger samples sizes could be used to qualify this parameter using an “attributes” approach. The solid diamonds are the average of measured data points from the biased sample (devices irradiated with an electrical bias) while the shaded diamonds are the average from the unbiased sample. The black lines show the effects on the data after application of the biased KTL statistics (solid and dashed lines) while the gray lines show the effects on the data after application of the unbiased KTL statistics (solid and dashed lines). The red dashed lines are the minimum and maximum specification values as



Table 5.28. Raw data for Open Loop Gain 10 RL=10k VO=+/-10V (V/mV) versus total dose, including the statistical analysis, the specification and the status of the testing (pass/fail).

Open Loop Gain 10 RL=10k VO=+/-10V (V/mV)	Total Dose (krad(Si))					24-hr Anneal	168-hr Anneal
	0	10	20	30	50		
Device							
1027	2.61E+04	3.74E+04	1.11E+04	9.42E+03	6.24E+03	5.26E+03	5.30E+03
1029	3.10E+04	1.65E+04	1.86E+04	8.61E+03	5.69E+03	5.12E+03	4.96E+03
1030	2.65E+04	2.46E+04	3.23E+04	7.21E+04	4.36E+04	2.51E+04	1.87E+04
1031	7.36E+03	6.95E+03	5.27E+03	5.61E+03	3.25E+03	3.38E+03	3.65E+03
1032	1.51E+04	1.88E+04	7.17E+03	5.99E+03	3.87E+03	4.38E+03	3.86E+03
1033	8.53E+03	6.29E+03	6.07E+03	4.95E+03	3.69E+03	5.06E+03	4.11E+03
1034	7.65E+03	9.12E+03	7.88E+03	1.02E+04	1.23E+04	7.64E+03	1.39E+04
1035	1.16E+05	2.92E+04	1.93E+04	2.96E+04	1.21E+04	1.11E+04	1.45E+04
1036	1.12E+04	5.77E+03	6.59E+03	7.09E+03	3.52E+03	3.61E+03	3.89E+03
1038	1.24E+04	1.37E+04	7.74E+03	5.68E+03	4.24E+03	4.55E+03	4.08E+03
1039	1.28E+05	6.53E+05	1.59E+05	6.42E+05	6.23E+04	7.71E+04	1.82E+05
<b>Biased Statistics</b>							
Average Biased	2.12E+04	2.08E+04	1.49E+04	2.03E+04	1.25E+04	8.65E+03	7.29E+03
Std Dev Biased	9.70E+03	1.12E+04	1.10E+04	2.90E+04	1.74E+04	9.23E+03	6.43E+03
Ps99%/90% (+KTL) Biased	6.65E+04	7.33E+04	6.61E+04	1.56E+05	9.38E+04	5.17E+04	3.73E+04
Ps99%/90% (-KTL) Biased	-2.41E+04	-3.16E+04	-3.63E+04	-1.15E+05	-6.87E+04	-3.44E+04	-2.27E+04
<b>Un-Biased Statistics</b>							
Average Un-Biased	3.11E+04	1.28E+04	9.52E+03	1.15E+04	7.15E+03	6.38E+03	8.10E+03
Std Dev Un-Biased	4.74E+04	9.67E+03	5.52E+03	1.03E+04	4.58E+03	3.01E+03	5.58E+03
Ps99%/90% (+KTL) Un-Biased	2.52E+05	5.79E+04	3.53E+04	5.97E+04	2.85E+04	2.04E+04	3.41E+04
Ps99%/90% (-KTL) Un-Biased	-1.90E+05	-3.23E+04	-1.63E+04	-3.67E+04	-1.42E+04	-7.65E+03	-1.79E+04
<b>Specification MIN</b>	<b>1.20E+03</b>	<b>5.00E+02</b>	<b>2.00E+02</b>	<b>2.00E+02</b>	<b>1.00E+02</b>	<b>1.00E+02</b>	<b>1.00E+02</b>
Status	FAIL	FAIL	FAIL	FAIL	FAIL	FAIL	FAIL

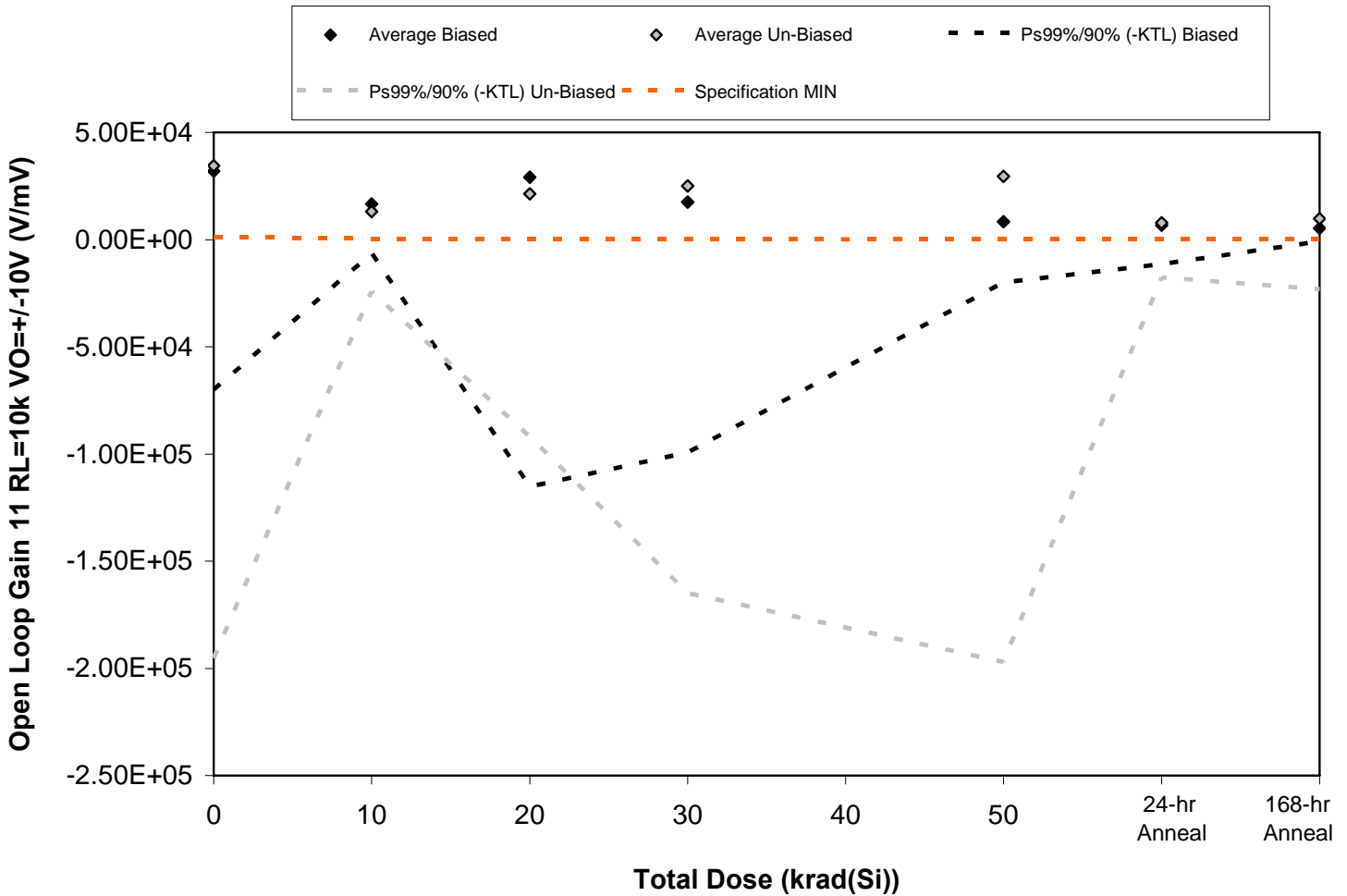

Figure 5.29. Plot of Open Loop Gain 11 RL=10k VO=+/-10V (V/mV) versus total dose. The data show significant degradation with radiation, however not sufficient for the average of the measured data to fall below the specification limit. Note that the testing and statistics used in this figure are based on an “analysis of variables” technique, which relies on small sample sizes to qualify much larger lot sizes (see MIL-HDBK-814, p. 91 for a discussion of statistical treatments). Unfortunately, this parameter is not well suited to this approach due to inherent large variations. If necessary, larger samples sizes could be used to qualify this parameter using an “attributes” approach. The solid diamonds are the average of measured data points from the biased sample (devices irradiated with an electrical bias) while the shaded diamonds are the average from the unbiased sample. The black lines show the effects on the data after application of the biased KTL statistics (solid and dashed lines) while the gray lines show the effects on the data after application of the unbiased KTL statistics (solid and dashed lines). The red dashed lines are the minimum and maximum specification values as





Table 5.29. Raw data for Open Loop Gain 11 RL=10k VO=+/-10V (V/mV) versus total dose, including the statistical analysis, the specification and the status of the testing (pass/fail).

Open Loop Gain 11 RL=10k VO=+/-10V (V/mV)	Total Dose (krad(Si))					24-hr Anneal	168-hr Anneal
	0	10	20	30	50		
Device							
1027	1.58E+04	1.54E+04	2.48E+04	4.80E+03	5.08E+03	8.06E+03	5.99E+03
1029	3.69E+04	2.05E+04	1.29E+04	7.42E+03	8.42E+03	6.03E+03	6.06E+03
1030	1.19E+04	1.84E+04	8.35E+04	6.23E+04	1.87E+04	1.27E+04	6.29E+03
1031	6.66E+04	2.01E+04	1.53E+04	5.68E+03	4.17E+03	3.42E+03	3.11E+03
1032	2.82E+04	8.51E+03	9.11E+03	7.38E+03	5.07E+03	3.37E+03	5.09E+03
1033	6.04E+03	9.28E+03	6.97E+03	4.11E+03	4.46E+03	3.29E+03	5.45E+03
1034	2.50E+04	2.10E+04	2.56E+04	1.46E+04	1.15E+05	1.38E+04	2.00E+04
1035	1.22E+05	2.23E+04	6.21E+04	9.74E+04	2.08E+04	1.38E+04	1.41E+04
1036	8.40E+03	7.01E+03	6.45E+03	4.07E+03	3.48E+03	4.74E+03	4.01E+03
1038	1.14E+04	5.55E+03	5.58E+03	5.00E+03	3.55E+03	3.51E+03	4.98E+03
1039	1.98E+04	1.45E+04	4.70E+04	2.94E+04	1.49E+04	2.02E+04	2.92E+04
<b>Biased Statistics</b>							
Average Biased	3.19E+04	1.66E+04	2.91E+04	1.75E+04	8.29E+03	6.72E+03	5.30E+03
Std Dev Biased	2.18E+04	4.93E+03	3.09E+04	2.50E+04	6.04E+03	3.89E+03	1.31E+03
Ps99%/90% (+KTL) Biased	1.34E+05	3.96E+04	1.73E+05	1.34E+05	3.64E+04	2.49E+04	1.14E+04
Ps99%/90% (-KTL) Biased	-6.99E+04	-6.46E+03	-1.15E+05	-9.93E+04	-1.99E+04	-1.14E+04	-8.16E+02
<b>Un-Biased Statistics</b>							
Average Un-Biased	3.45E+04	1.30E+04	2.13E+04	2.50E+04	2.95E+04	7.82E+03	9.70E+03
Std Dev Un-Biased	4.93E+04	8.00E+03	2.43E+04	4.07E+04	4.85E+04	5.47E+03	7.02E+03
Ps99%/90% (+KTL) Un-Biased	2.64E+05	5.03E+04	1.35E+05	2.15E+05	2.56E+05	3.33E+04	4.25E+04
Ps99%/90% (-KTL) Un-Biased	-1.95E+05	-2.43E+04	-9.19E+04	-1.65E+05	-1.97E+05	-1.77E+04	-2.31E+04
<b>Specification MIN</b>	<b>1.20E+03</b>	<b>5.00E+02</b>	<b>2.00E+02</b>	<b>2.00E+02</b>	<b>1.00E+02</b>	<b>1.00E+02</b>	<b>1.00E+02</b>
Status	FAIL	FAIL	FAIL	FAIL	FAIL	FAIL	FAIL

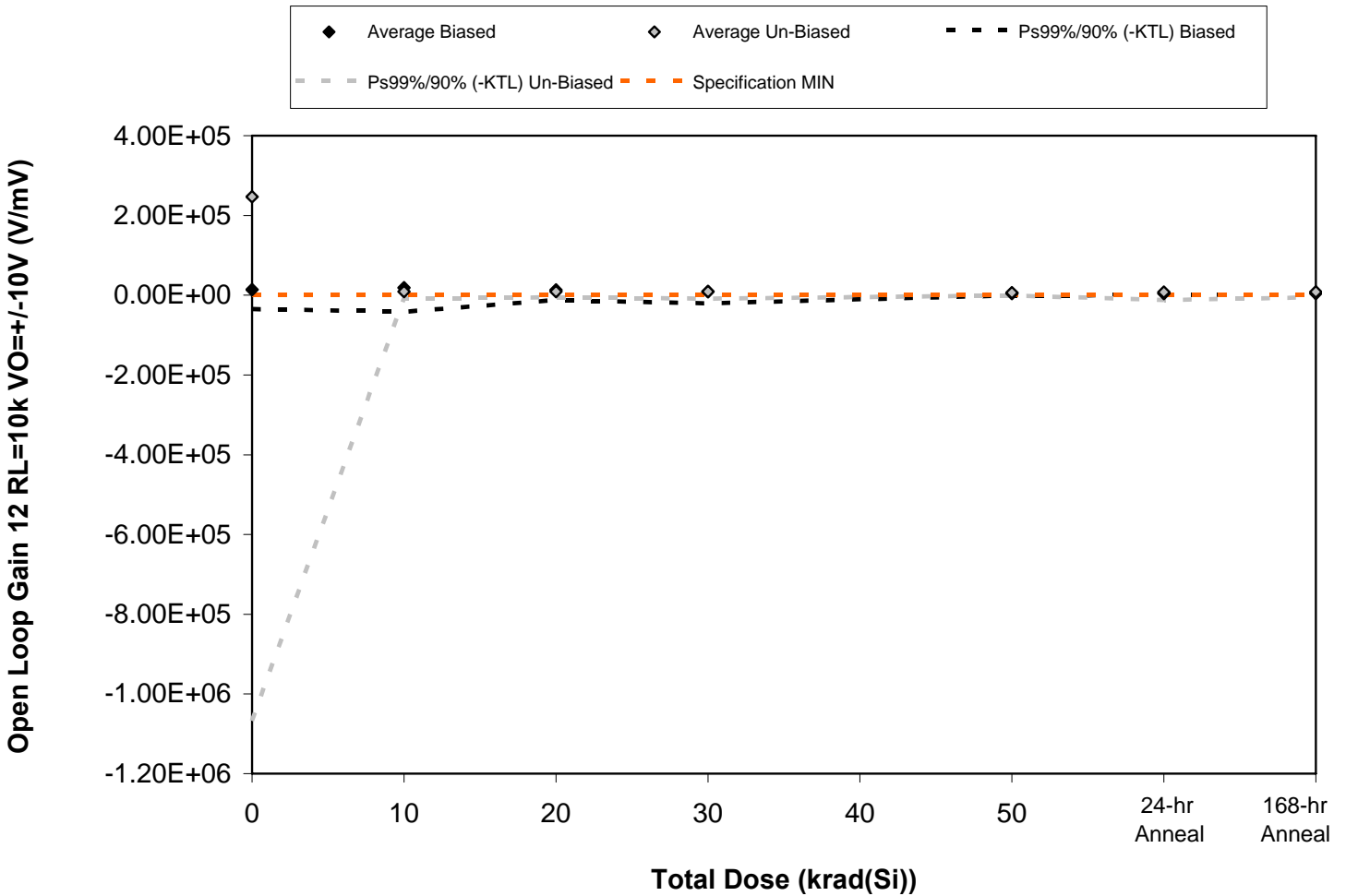

Figure 5.30. Plot of Open Loop Gain 12 RL=10k VO=+-10V (V/mV) versus total dose. The data show significant degradation with radiation, however not sufficient for the average of the measured data to fall below the specification limit. Note that the testing and statistics used in this figure are based on an “analysis of variables” technique, which relies on small sample sizes to qualify much larger lot sizes (see MIL-HDBK-814, p. 91 for a discussion of statistical treatments). Unfortunately, this parameter is not well suited to this approach due to inherent large variations. If necessary, larger samples sizes could be used to qualify this parameter using an “attributes” approach. The solid diamonds are the average of measured data points from the biased sample (devices irradiated with an electrical bias) while the shaded diamonds are the average from the unbiased sample. The black lines show the effects on the data after application of the biased KTL statistics (solid and dashed lines) while the gray lines show the effects on the data after application of the unbiased KTL statistics (solid and dashed lines). The red dashed lines are the minimum and maximum specification values as



Table 5.30. Raw data for Open Loop Gain 12 RL=10k VO=+/-10V (V/mV) versus total dose, including the statistical analysis, the specification and the status of the testing (pass/fail).

Open Loop Gain 12 RL=10k VO=+/-10V (V/mV)	Total Dose (krad(Si))					24-hr Anneal	168-hr Anneal
	0	10	20	30	50		
Device							
1027	7.88E+03	4.05E+04	1.11E+04	1.95E+04	4.98E+03	3.60E+03	3.87E+03
1029	3.20E+04	2.04E+04	2.18E+04	8.58E+03	4.50E+03	5.62E+03	4.77E+03
1030	6.67E+03	1.08E+04	1.46E+04	4.46E+03	3.28E+03	3.57E+03	4.85E+03
1031	1.10E+04	9.47E+03	8.26E+03	6.83E+03	5.92E+03	5.09E+03	4.75E+03
1032	1.12E+04	1.25E+04	1.00E+04	4.32E+03	3.93E+03	3.87E+03	3.23E+03
1033	1.59E+04	5.04E+03	6.34E+03	4.42E+03	4.14E+03	4.03E+03	3.49E+03
1034	5.41E+05	1.33E+04	9.51E+03	7.13E+03	6.60E+03	1.39E+04	1.02E+04
1035	1.73E+04	8.03E+03	1.14E+04	8.00E+03	5.31E+03	6.21E+03	1.08E+04
1036	9.54E+04	7.12E+03	5.74E+03	1.14E+04	7.13E+03	4.34E+03	9.36E+03
1038	5.67E+05	1.30E+04	1.26E+04	1.43E+04	7.89E+03	1.02E+04	8.96E+03
1039	2.69E+04	1.71E+04	2.99E+05	1.43E+05	1.64E+04	1.12E+05	2.43E+04
<b>Biased Statistics</b>							
Average Biased	1.38E+04	1.87E+04	1.31E+04	8.73E+03	4.52E+03	4.35E+03	4.29E+03
Std Dev Biased	1.04E+04	1.29E+04	5.37E+03	6.26E+03	1.01E+03	9.42E+02	7.16E+02
Ps99%/90% (+KTL) Biased	6.22E+04	7.88E+04	3.82E+04	3.79E+04	9.22E+03	8.74E+03	7.63E+03
Ps99%/90% (-KTL) Biased	-3.47E+04	-4.13E+04	-1.19E+04	-2.05E+04	-1.75E+02	-4.26E+01	9.53E+02
<b>Un-Biased Statistics</b>							
Average Un-Biased	2.47E+05	9.29E+03	9.13E+03	9.04E+03	6.21E+03	7.73E+03	8.57E+03
Std Dev Un-Biased	2.82E+05	3.67E+03	3.04E+03	3.85E+03	1.49E+03	4.24E+03	2.94E+03
Ps99%/90% (+KTL) Un-Biased	1.56E+06	2.64E+04	2.33E+04	2.70E+04	1.32E+04	2.75E+04	2.23E+04
Ps99%/90% (-KTL) Un-Biased	-1.07E+06	-7.82E+03	-5.05E+03	-8.91E+03	-7.55E+02	-1.20E+04	-5.13E+03
<b>Specification MIN</b>	<b>1.20E+03</b>	<b>5.00E+02</b>	<b>2.00E+02</b>	<b>2.00E+02</b>	<b>1.00E+02</b>	<b>1.00E+02</b>	<b>1.00E+02</b>
Status	FAIL	FAIL	FAIL	FAIL	FAIL	FAIL	FAIL

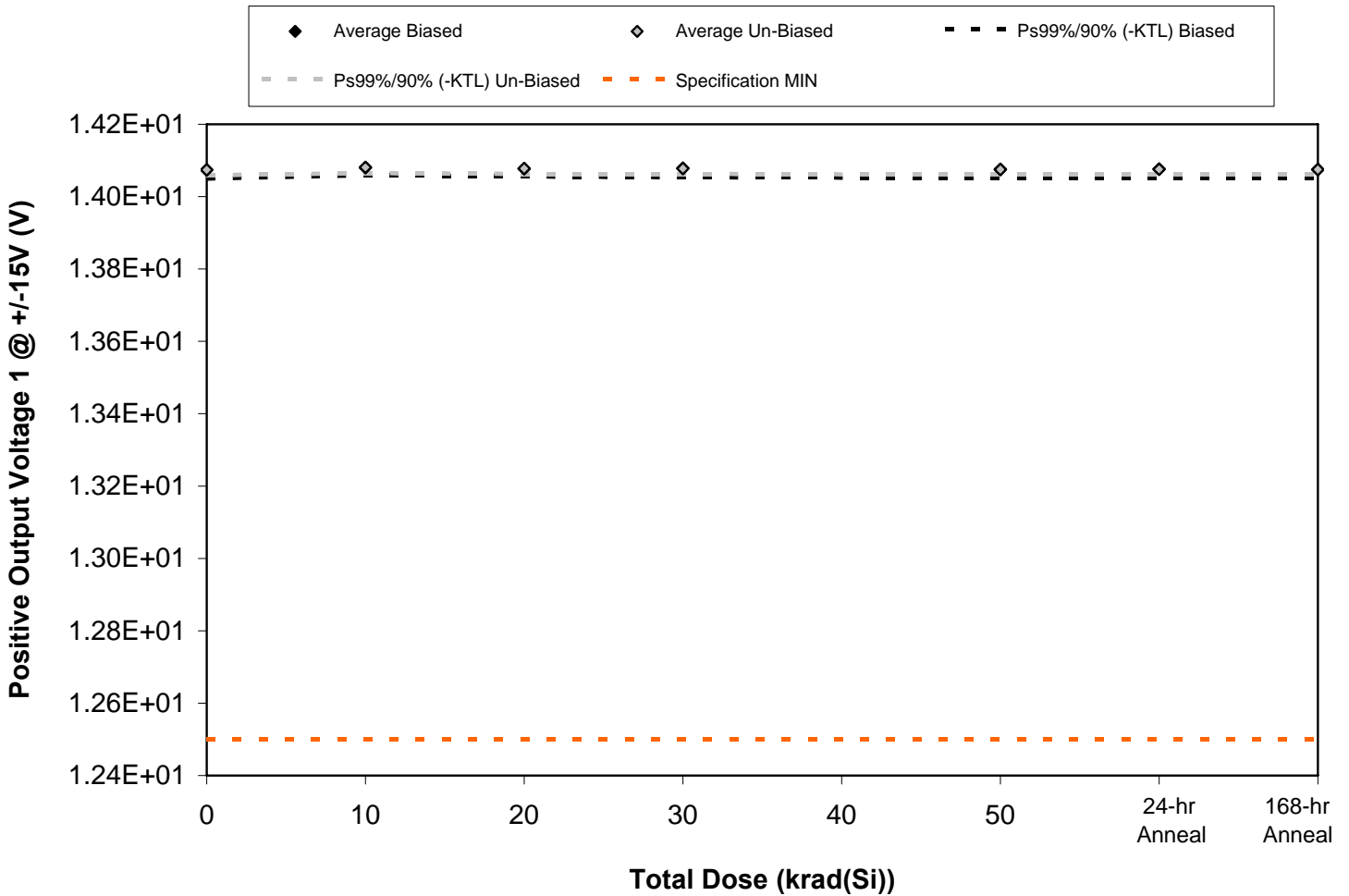

Figure 5.31. Plot of Positive Output Voltage 1 @ +/-15V (V) versus total dose. The data show no significant degradation with radiation. The solid diamonds are the average of measured data points from the biased sample (devices irradiated with an electrical bias) while the shaded diamonds are the average from the unbiased sample. The black lines show the effects on the data after application of the biased KTL statistics (solid and dashed lines) while the gray lines show the effects on the data after application of the unbiased KTL statistics (solid and dashed lines). The red dashed lines are the minimum and maximum specification values as defined in the datasheet and/or test plan.



Table 5.31. Raw data for Positive Output Voltage 1 @ +/-15V (V) versus total dose, including the statistical analysis, the specification and the status of the testing (pass/fail).

Positive Output Voltage 1 @ +/-15V (V)	Total Dose (krad(Si))					24-hr Anneal	168-hr Anneal
	0	10	20	30	50		
Device							
1027	1.41E+01	1.41E+01	1.41E+01	1.41E+01	1.41E+01	1.41E+01	1.41E+01
1029	1.41E+01	1.41E+01	1.41E+01	1.41E+01	1.41E+01	1.41E+01	1.41E+01
1030	1.41E+01	1.41E+01	1.41E+01	1.41E+01	1.41E+01	1.41E+01	1.41E+01
1031	1.41E+01	1.41E+01	1.41E+01	1.41E+01	1.41E+01	1.41E+01	1.41E+01
1032	1.41E+01	1.41E+01	1.41E+01	1.41E+01	1.41E+01	1.41E+01	1.41E+01
1033	1.41E+01	1.41E+01	1.41E+01	1.41E+01	1.41E+01	1.41E+01	1.41E+01
1034	1.41E+01	1.41E+01	1.41E+01	1.41E+01	1.41E+01	1.41E+01	1.41E+01
1035	1.41E+01	1.41E+01	1.41E+01	1.41E+01	1.41E+01	1.41E+01	1.41E+01
1036	1.41E+01	1.41E+01	1.41E+01	1.41E+01	1.41E+01	1.41E+01	1.41E+01
1038	1.41E+01	1.41E+01	1.41E+01	1.41E+01	1.41E+01	1.41E+01	1.41E+01
1039	1.41E+01	1.41E+01	1.41E+01	1.41E+01	1.41E+01	1.41E+01	1.41E+01
<b>Biased Statistics</b>							
Average Biased	1.41E+01	1.41E+01	1.41E+01	1.41E+01	1.41E+01	1.41E+01	1.41E+01
Std Dev Biased	5.17E-03	4.60E-03	4.60E-03	5.22E-03	5.17E-03	5.22E-03	4.97E-03
Ps99%/90% (+KTL) Biased	1.41E+01	1.41E+01	1.41E+01	1.41E+01	1.41E+01	1.41E+01	1.41E+01
Ps99%/90% (-KTL) Biased	1.41E+01	1.41E+01	1.41E+01	1.41E+01	1.41E+01	1.41E+01	1.41E+01
<b>Un-Biased Statistics</b>							
Average Un-Biased	1.41E+01	1.41E+01	1.41E+01	1.41E+01	1.41E+01	1.41E+01	1.41E+01
Std Dev Un-Biased	3.35E-03	3.29E-03	3.29E-03	3.29E-03	3.16E-03	3.29E-03	2.77E-03
Ps99%/90% (+KTL) Un-Biased	1.41E+01	1.41E+01	1.41E+01	1.41E+01	1.41E+01	1.41E+01	1.41E+01
Ps99%/90% (-KTL) Un-Biased	1.41E+01	1.41E+01	1.41E+01	1.41E+01	1.41E+01	1.41E+01	1.41E+01
<b>Specification MIN</b>	<b>1.25E+01</b>	<b>1.25E+01</b>	<b>1.25E+01</b>	<b>1.25E+01</b>	<b>1.25E+01</b>	<b>1.25E+01</b>	<b>1.25E+01</b>
Status	PASS	PASS	PASS	PASS	PASS	PASS	PASS

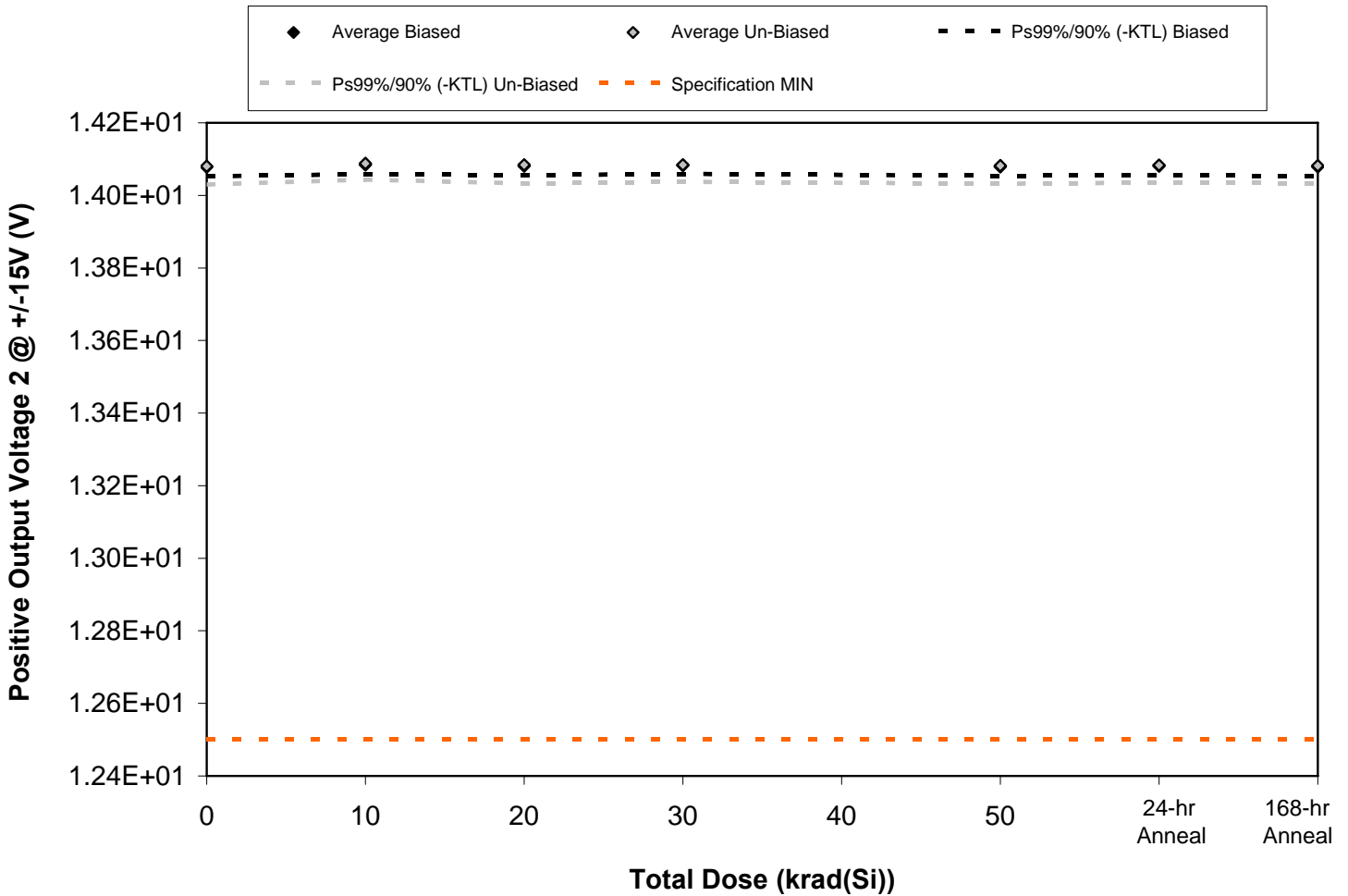

Figure 5.32. Plot of Positive Output Voltage 2 @ +/-15V (V) versus total dose. The data show no significant degradation with radiation. The solid diamonds are the average of measured data points from the biased sample (devices irradiated with an electrical bias) while the shaded diamonds are the average from the unbiased sample. The black lines show the effects on the data after application of the biased KTL statistics (solid and dashed lines) while the gray lines show the effects on the data after application of the unbiased KTL statistics (solid and dashed lines). The red dashed lines are the minimum and maximum specification values as defined in the datasheet and/or test plan.



Table 5.32. Raw data for Positive Output Voltage 2 @ +/-15V (V) versus total dose, including the statistical analysis, the specification and the status of the testing (pass/fail).

Positive Output Voltage 2 @ +/-15V (V)	Total Dose (krad(Si))					24-hr Anneal	168-hr Anneal
	0	10	20	30	50		
Device							
1027	1.41E+01	1.41E+01	1.41E+01	1.41E+01	1.41E+01	1.41E+01	1.41E+01
1029	1.41E+01	1.41E+01	1.41E+01	1.41E+01	1.41E+01	1.41E+01	1.41E+01
1030	1.41E+01	1.41E+01	1.41E+01	1.41E+01	1.41E+01	1.41E+01	1.41E+01
1031	1.41E+01	1.41E+01	1.41E+01	1.41E+01	1.41E+01	1.41E+01	1.41E+01
1032	1.41E+01	1.41E+01	1.41E+01	1.41E+01	1.41E+01	1.41E+01	1.41E+01
1033	1.41E+01	1.41E+01	1.41E+01	1.41E+01	1.41E+01	1.41E+01	1.41E+01
1034	1.41E+01	1.41E+01	1.41E+01	1.41E+01	1.41E+01	1.41E+01	1.41E+01
1035	1.41E+01	1.41E+01	1.41E+01	1.41E+01	1.41E+01	1.41E+01	1.41E+01
1036	1.41E+01	1.41E+01	1.41E+01	1.41E+01	1.41E+01	1.41E+01	1.41E+01
1038	1.41E+01	1.41E+01	1.41E+01	1.41E+01	1.41E+01	1.41E+01	1.41E+01
1039	1.41E+01	1.41E+01	1.41E+01	1.41E+01	1.41E+01	1.41E+01	1.41E+01
<b>Biased Statistics</b>							
Average Biased	1.41E+01	1.41E+01	1.41E+01	1.41E+01	1.41E+01	1.41E+01	1.41E+01
Std Dev Biased	5.40E-03	5.40E-03	5.40E-03	5.03E-03	5.39E-03	5.40E-03	5.40E-03
Ps99%/90% (+KTL) Biased	1.41E+01	1.41E+01	1.41E+01	1.41E+01	1.41E+01	1.41E+01	1.41E+01
Ps99%/90% (-KTL) Biased	1.41E+01	1.41E+01	1.41E+01	1.41E+01	1.41E+01	1.41E+01	1.41E+01
<b>Un-Biased Statistics</b>							
Average Un-Biased	1.41E+01	1.41E+01	1.41E+01	1.41E+01	1.41E+01	1.41E+01	1.41E+01
Std Dev Un-Biased	1.08E-02	9.55E-03	1.10E-02	1.01E-02	1.06E-02	1.03E-02	1.03E-02
Ps99%/90% (+KTL) Un-Biased	1.41E+01	1.41E+01	1.41E+01	1.41E+01	1.41E+01	1.41E+01	1.41E+01
Ps99%/90% (-KTL) Un-Biased	1.40E+01	1.40E+01	1.40E+01	1.40E+01	1.40E+01	1.40E+01	1.40E+01
<b>Specification MIN</b>	<b>1.25E+01</b>	<b>1.25E+01</b>	<b>1.25E+01</b>	<b>1.25E+01</b>	<b>1.25E+01</b>	<b>1.25E+01</b>	<b>1.25E+01</b>
Status	PASS	PASS	PASS	PASS	PASS	PASS	PASS

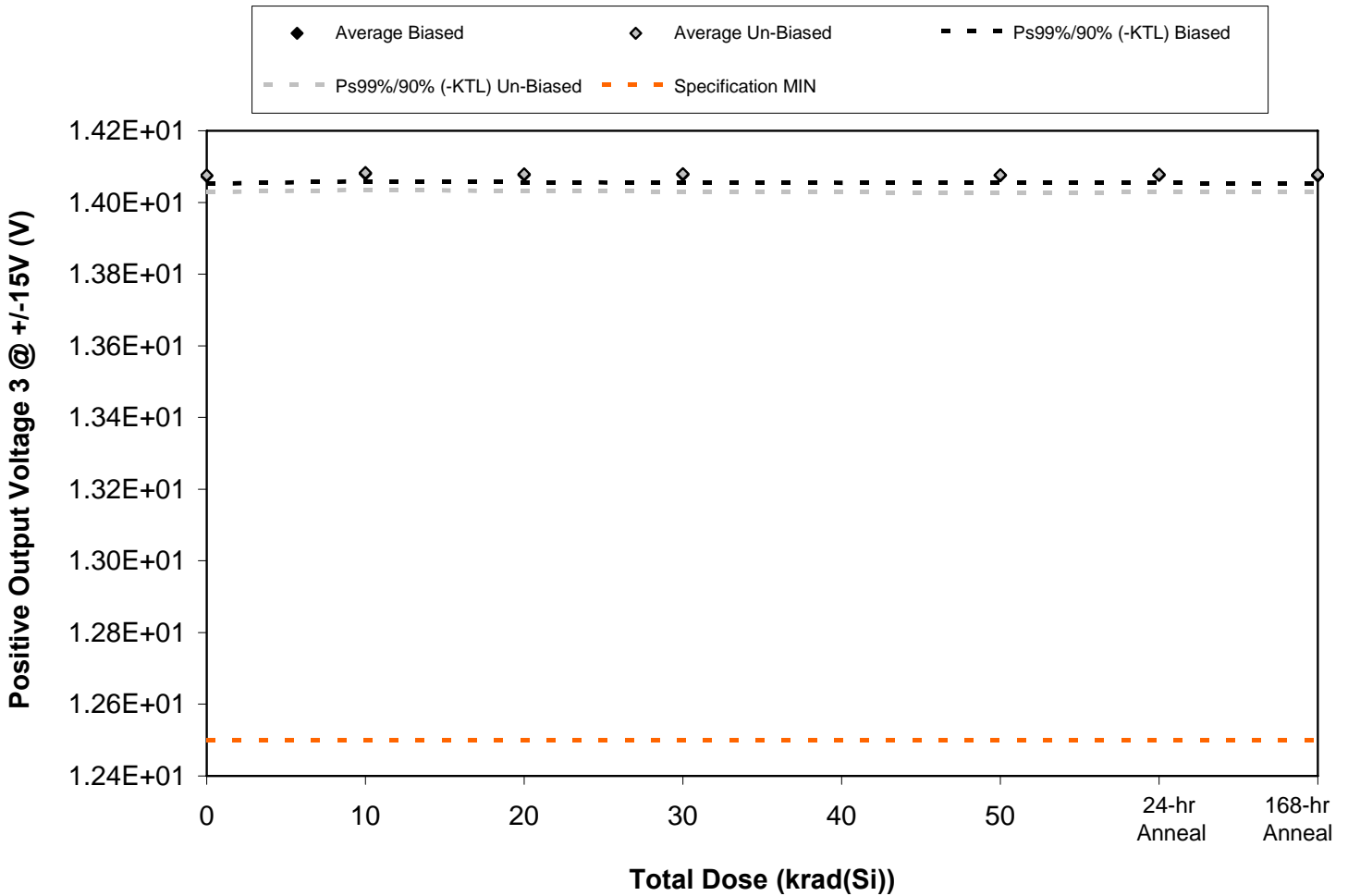

Figure 5.33. Plot of Positive Output Voltage 3 @ +/-15V (V) versus total dose. The data show no significant degradation with radiation. The solid diamonds are the average of measured data points from the biased sample (devices irradiated with an electrical bias) while the shaded diamonds are the average from the unbiased sample. The black lines show the effects on the data after application of the biased KTL statistics (solid and dashed lines) while the gray lines show the effects on the data after application of the unbiased KTL statistics (solid and dashed lines). The red dashed lines are the minimum and maximum specification values as defined in the datasheet and/or test plan.





Table 5.33. Raw data for Positive Output Voltage 3 @ +/-15V (V) versus total dose, including the statistical analysis, the specification and the status of the testing (pass/fail).

Positive Output Voltage 3 @ +/-15V (V)	Total Dose (krad(Si))					24-hr Anneal	168-hr Anneal
	0	10	20	30	50		
Device							
1027	1.41E+01	1.41E+01	1.41E+01	1.41E+01	1.41E+01	1.41E+01	1.41E+01
1029	1.41E+01	1.41E+01	1.41E+01	1.41E+01	1.41E+01	1.41E+01	1.41E+01
1030	1.41E+01	1.41E+01	1.41E+01	1.41E+01	1.41E+01	1.41E+01	1.41E+01
1031	1.41E+01	1.41E+01	1.41E+01	1.41E+01	1.41E+01	1.41E+01	1.41E+01
1032	1.41E+01	1.41E+01	1.41E+01	1.41E+01	1.41E+01	1.41E+01	1.41E+01
1033	1.41E+01	1.41E+01	1.41E+01	1.41E+01	1.41E+01	1.41E+01	1.41E+01
1034	1.41E+01	1.41E+01	1.41E+01	1.41E+01	1.41E+01	1.41E+01	1.41E+01
1035	1.41E+01	1.41E+01	1.41E+01	1.41E+01	1.41E+01	1.41E+01	1.41E+01
1036	1.41E+01	1.41E+01	1.41E+01	1.41E+01	1.41E+01	1.41E+01	1.41E+01
1038	1.41E+01	1.41E+01	1.41E+01	1.41E+01	1.41E+01	1.41E+01	1.41E+01
1039	1.41E+01	1.41E+01	1.41E+01	1.41E+01	1.41E+01	1.41E+01	1.41E+01
<b>Biased Statistics</b>							
Average Biased	1.41E+01	1.41E+01	1.41E+01	1.41E+01	1.41E+01	1.41E+01	1.41E+01
Std Dev Biased	4.56E-03	4.38E-03	4.38E-03	4.77E-03	4.38E-03	4.60E-03	4.60E-03
Ps99%/90% (+KTL) Biased	1.41E+01	1.41E+01	1.41E+01	1.41E+01	1.41E+01	1.41E+01	1.41E+01
Ps99%/90% (-KTL) Biased	1.41E+01	1.41E+01	1.41E+01	1.41E+01	1.41E+01	1.41E+01	1.41E+01
<b>Un-Biased Statistics</b>							
Average Un-Biased	1.41E+01	1.41E+01	1.41E+01	1.41E+01	1.41E+01	1.41E+01	1.41E+01
Std Dev Un-Biased	1.03E-02	1.01E-02	1.03E-02	1.06E-02	1.06E-02	1.06E-02	1.04E-02
Ps99%/90% (+KTL) Un-Biased	1.41E+01	1.41E+01	1.41E+01	1.41E+01	1.41E+01	1.41E+01	1.41E+01
Ps99%/90% (-KTL) Un-Biased	1.40E+01	1.40E+01	1.40E+01	1.40E+01	1.40E+01	1.40E+01	1.40E+01
<b>Specification MIN</b>	<b>1.25E+01</b>	<b>1.25E+01</b>	<b>1.25E+01</b>	<b>1.25E+01</b>	<b>1.25E+01</b>	<b>1.25E+01</b>	<b>1.25E+01</b>
Status	PASS	PASS	PASS	PASS	PASS	PASS	PASS

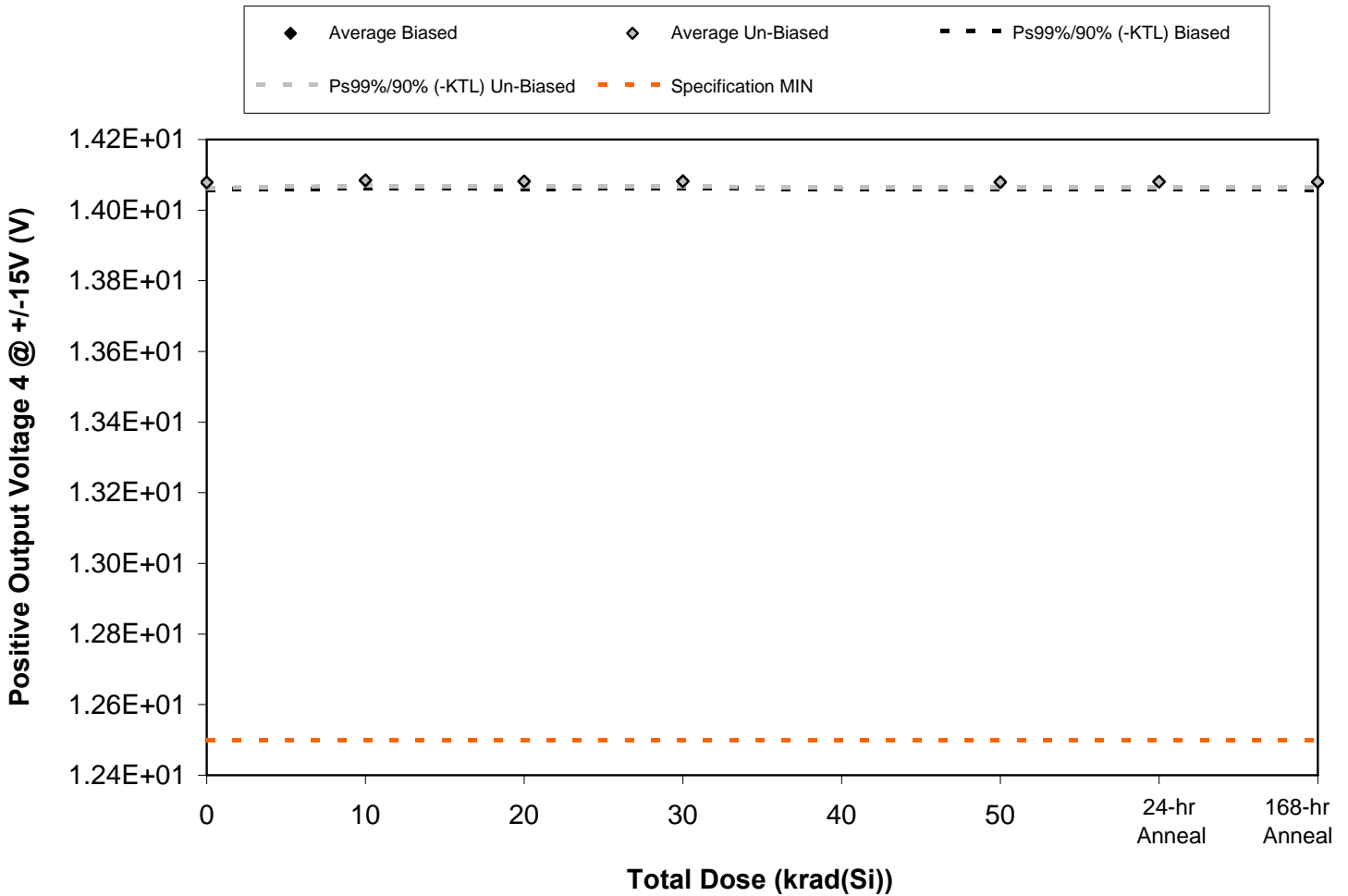

Figure 5.34. Plot of Positive Output Voltage 4 @ +/-15V (V) versus total dose. The data show no significant degradation with radiation. The solid diamonds are the average of measured data points from the biased sample (devices irradiated with an electrical bias) while the shaded diamonds are the average from the unbiased sample. The black lines show the effects on the data after application of the biased KTL statistics (solid and dashed lines) while the gray lines show the effects on the data after application of the unbiased KTL statistics (solid and dashed lines). The red dashed lines are the minimum and maximum specification values as defined in the datasheet and/or test plan.



Table 5.34. Raw data for Positive Output Voltage 4 @ +/-15V (V) versus total dose, including the statistical analysis, the specification and the status of the testing (pass/fail).

Positive Output Voltage 4 @ +/-15V (V)	Total Dose (krad(Si))					24-hr Anneal	168-hr Anneal
	0	10	20	30	50		
Device							
1027	1.41E+01	1.41E+01	1.41E+01	1.41E+01	1.41E+01	1.41E+01	1.41E+01
1029	1.41E+01	1.41E+01	1.41E+01	1.41E+01	1.41E+01	1.41E+01	1.41E+01
1030	1.41E+01	1.41E+01	1.41E+01	1.41E+01	1.41E+01	1.41E+01	1.41E+01
1031	1.41E+01	1.41E+01	1.41E+01	1.41E+01	1.41E+01	1.41E+01	1.41E+01
1032	1.41E+01	1.41E+01	1.41E+01	1.41E+01	1.41E+01	1.41E+01	1.41E+01
1033	1.41E+01	1.41E+01	1.41E+01	1.41E+01	1.41E+01	1.41E+01	1.41E+01
1034	1.41E+01	1.41E+01	1.41E+01	1.41E+01	1.41E+01	1.41E+01	1.41E+01
1035	1.41E+01	1.41E+01	1.41E+01	1.41E+01	1.41E+01	1.41E+01	1.41E+01
1036	1.41E+01	1.41E+01	1.41E+01	1.41E+01	1.41E+01	1.41E+01	1.41E+01
1038	1.41E+01	1.41E+01	1.41E+01	1.41E+01	1.41E+01	1.41E+01	1.41E+01
1039	1.41E+01	1.41E+01	1.41E+01	1.41E+01	1.41E+01	1.41E+01	1.41E+01
<b>Biased Statistics</b>							
Average Biased	1.41E+01	1.41E+01	1.41E+01	1.41E+01	1.41E+01	1.41E+01	1.41E+01
Std Dev Biased	4.45E-03	4.60E-03	4.45E-03	4.44E-03	4.45E-03	4.60E-03	4.60E-03
Ps99%/90% (+KTL) Biased	1.41E+01	1.41E+01	1.41E+01	1.41E+01	1.41E+01	1.41E+01	1.41E+01
Ps99%/90% (-KTL) Biased	1.41E+01	1.41E+01	1.41E+01	1.41E+01	1.41E+01	1.41E+01	1.41E+01
<b>Un-Biased Statistics</b>							
Average Un-Biased	1.41E+01	1.41E+01	1.41E+01	1.41E+01	1.41E+01	1.41E+01	1.41E+01
Std Dev Un-Biased	3.29E-03	3.35E-03	3.29E-03	3.35E-03	3.29E-03	3.21E-03	3.35E-03
Ps99%/90% (+KTL) Un-Biased	1.41E+01	1.41E+01	1.41E+01	1.41E+01	1.41E+01	1.41E+01	1.41E+01
Ps99%/90% (-KTL) Un-Biased	1.41E+01	1.41E+01	1.41E+01	1.41E+01	1.41E+01	1.41E+01	1.41E+01
<b>Specification MIN</b>	<b>1.25E+01</b>	<b>1.25E+01</b>	<b>1.25E+01</b>	<b>1.25E+01</b>	<b>1.25E+01</b>	<b>1.25E+01</b>	<b>1.25E+01</b>
Status	PASS	PASS	PASS	PASS	PASS	PASS	PASS

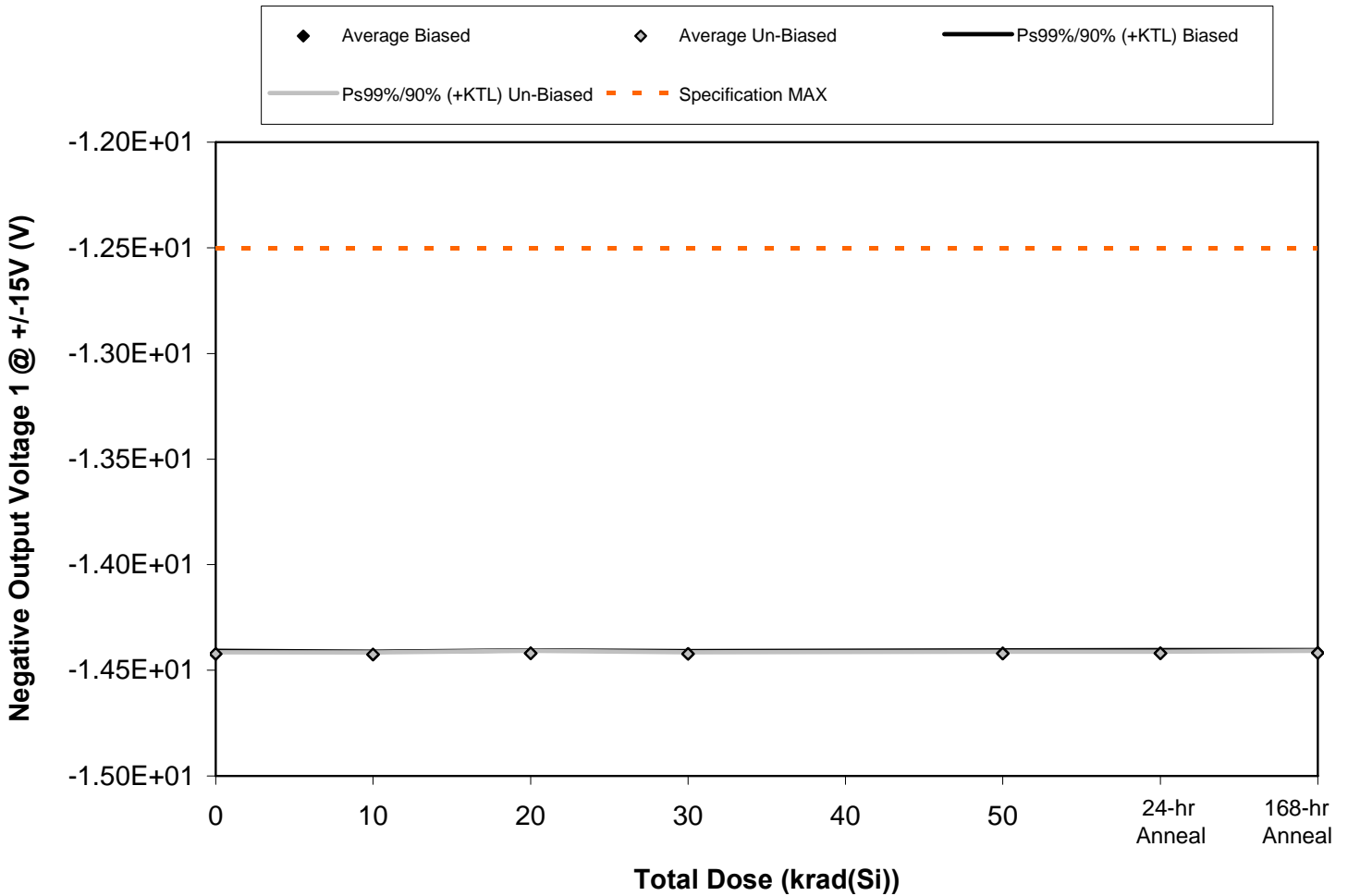

Figure 5.35. Plot of Negative Output Voltage 1 @ +/-15V (V) versus total dose. The data show no significant degradation with radiation. The solid diamonds are the average of measured data points from the biased sample (devices irradiated with an electrical bias) while the shaded diamonds are the average from the unbiased sample. The black lines show the effects on the data after application of the biased KTL statistics (solid and dashed lines) while the gray lines show the effects on the data after application of the unbiased KTL statistics (solid and dashed lines). The red dashed lines are the minimum and maximum specification values as defined in the datasheet and/or test plan.



Table 5.35. Raw data for Negative Output Voltage 1 @ +/-15V (V) versus total dose, including the statistical analysis, the specification and the status of the testing (pass/fail).

Negative Output Voltage 1 @ +/-15V (V)	Total Dose (krad(Si))					24-hr Anneal	168-hr Anneal
	0	10	20	30	50		
Device							
1027	-1.44E+01	-1.44E+01	-1.44E+01	-1.44E+01	-1.44E+01	-1.44E+01	-1.44E+01
1029	-1.44E+01	-1.44E+01	-1.44E+01	-1.44E+01	-1.44E+01	-1.44E+01	-1.44E+01
1030	-1.44E+01	-1.44E+01	-1.44E+01	-1.44E+01	-1.44E+01	-1.44E+01	-1.44E+01
1031	-1.44E+01	-1.44E+01	-1.44E+01	-1.44E+01	-1.44E+01	-1.44E+01	-1.44E+01
1032	-1.44E+01	-1.44E+01	-1.44E+01	-1.44E+01	-1.44E+01	-1.44E+01	-1.44E+01
1033	-1.44E+01	-1.44E+01	-1.44E+01	-1.44E+01	-1.44E+01	-1.44E+01	-1.44E+01
1034	-1.44E+01	-1.44E+01	-1.44E+01	-1.44E+01	-1.44E+01	-1.44E+01	-1.44E+01
1035	-1.44E+01	-1.44E+01	-1.44E+01	-1.44E+01	-1.44E+01	-1.44E+01	-1.44E+01
1036	-1.44E+01	-1.44E+01	-1.44E+01	-1.44E+01	-1.44E+01	-1.44E+01	-1.44E+01
1038	-1.44E+01	-1.44E+01	-1.44E+01	-1.44E+01	-1.44E+01	-1.44E+01	-1.44E+01
1039	-1.44E+01	-1.44E+01	-1.44E+01	-1.44E+01	-1.44E+01	-1.44E+01	-1.44E+01
<b>Biased Statistics</b>							
Average Biased	-1.44E+01	-1.44E+01	-1.44E+01	-1.44E+01	-1.44E+01	-1.44E+01	-1.44E+01
Std Dev Biased	3.08E-03	3.08E-03	3.13E-03	2.83E-03	3.13E-03	3.29E-03	2.77E-03
Ps99%/90% (+KTL) Biased	-1.44E+01	-1.44E+01	-1.44E+01	-1.44E+01	-1.44E+01	-1.44E+01	-1.44E+01
Ps99%/90% (-KTL) Biased	-1.44E+01	-1.44E+01	-1.44E+01	-1.44E+01	-1.44E+01	-1.44E+01	-1.44E+01
<b>Un-Biased Statistics</b>							
Average Un-Biased	-1.44E+01	-1.44E+01	-1.44E+01	-1.44E+01	-1.44E+01	-1.44E+01	-1.44E+01
Std Dev Un-Biased	1.64E-03	2.00E-03	2.51E-03	1.79E-03	1.95E-03	1.79E-03	2.28E-03
Ps99%/90% (+KTL) Un-Biased	-1.44E+01	-1.44E+01	-1.44E+01	-1.44E+01	-1.44E+01	-1.44E+01	-1.44E+01
Ps99%/90% (-KTL) Un-Biased	-1.44E+01	-1.44E+01	-1.44E+01	-1.44E+01	-1.44E+01	-1.44E+01	-1.44E+01
<b>Specification MAX</b>	<b>-1.25E+01</b>	<b>-1.25E+01</b>	<b>-1.25E+01</b>	<b>-1.25E+01</b>	<b>-1.25E+01</b>	<b>-1.25E+01</b>	<b>-1.25E+01</b>
Status	PASS	PASS	PASS	PASS	PASS	PASS	PASS

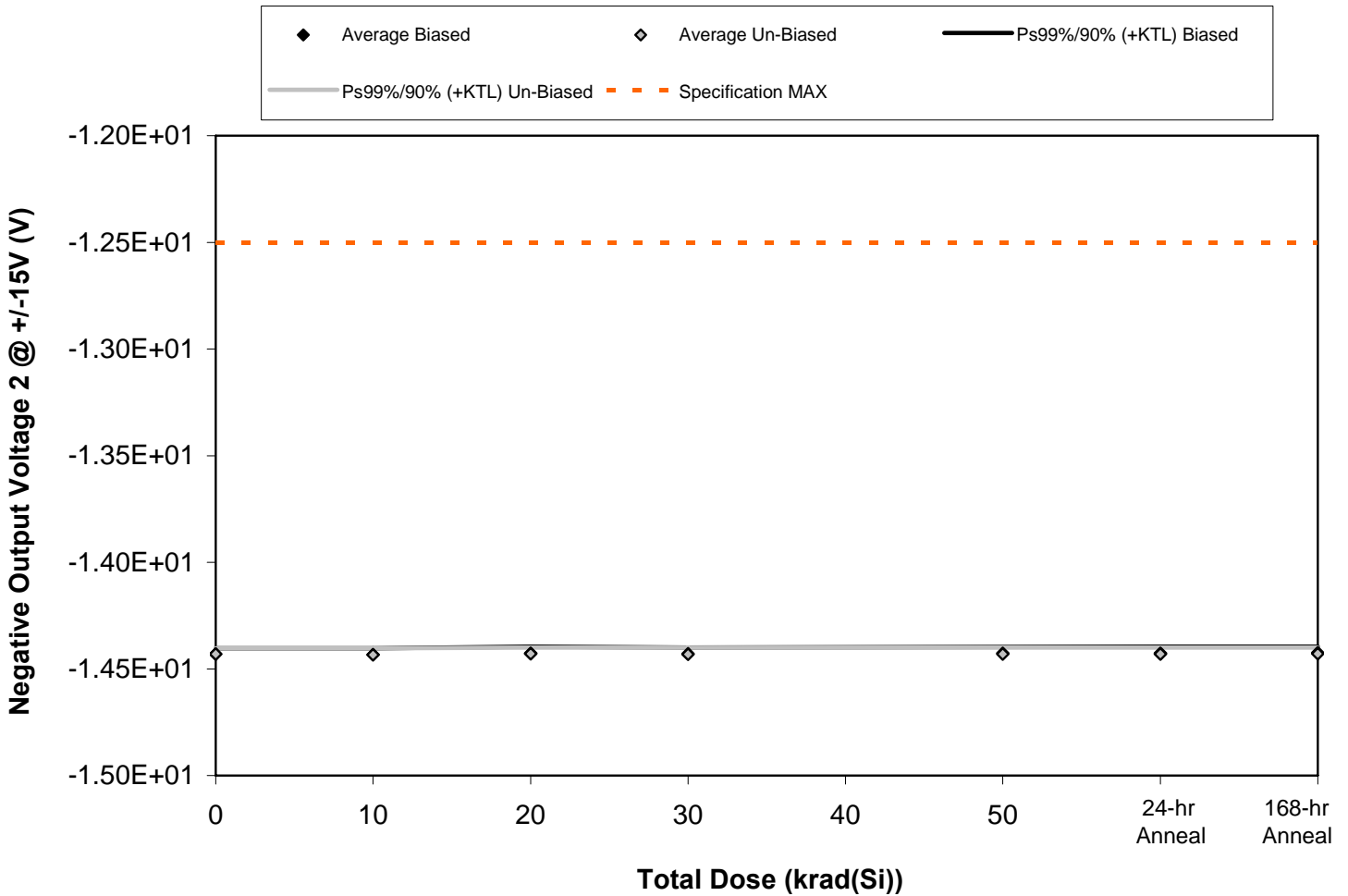

Figure 5.36. Plot of Negative Output Voltage 2 @ +/-15V (V) versus total dose. The data show no significant degradation with radiation. The solid diamonds are the average of measured data points from the biased sample (devices irradiated with an electrical bias) while the shaded diamonds are the average from the unbiased sample. The black lines show the effects on the data after application of the biased KTL statistics (solid and dashed lines) while the gray lines show the effects on the data after application of the unbiased KTL statistics (solid and dashed lines). The red dashed lines are the minimum and maximum specification values as defined in the datasheet and/or test plan.



Table 5.36. Raw data for Negative Output Voltage 2 @ +/-15V (V) versus total dose, including the statistical analysis, the specification and the status of the testing (pass/fail).

Negative Output Voltage 2 @ +/-15V (V)	Total Dose (krad(Si))					24-hr Anneal	168-hr Anneal
	0	10	20	30	50		
Device							
1027	-1.44E+01	-1.44E+01	-1.44E+01	-1.44E+01	-1.44E+01	-1.44E+01	-1.44E+01
1029	-1.44E+01	-1.44E+01	-1.44E+01	-1.44E+01	-1.44E+01	-1.44E+01	-1.44E+01
1030	-1.44E+01	-1.44E+01	-1.44E+01	-1.44E+01	-1.44E+01	-1.44E+01	-1.44E+01
1031	-1.44E+01	-1.44E+01	-1.44E+01	-1.44E+01	-1.44E+01	-1.44E+01	-1.44E+01
1032	-1.44E+01	-1.44E+01	-1.44E+01	-1.44E+01	-1.44E+01	-1.44E+01	-1.44E+01
1033	-1.44E+01	-1.44E+01	-1.44E+01	-1.44E+01	-1.44E+01	-1.44E+01	-1.44E+01
1034	-1.44E+01	-1.44E+01	-1.44E+01	-1.44E+01	-1.44E+01	-1.44E+01	-1.44E+01
1035	-1.44E+01	-1.44E+01	-1.44E+01	-1.44E+01	-1.44E+01	-1.44E+01	-1.44E+01
1036	-1.44E+01	-1.44E+01	-1.44E+01	-1.44E+01	-1.44E+01	-1.44E+01	-1.44E+01
1038	-1.44E+01	-1.44E+01	-1.44E+01	-1.44E+01	-1.44E+01	-1.44E+01	-1.44E+01
1039	-1.44E+01	-1.44E+01	-1.44E+01	-1.44E+01	-1.44E+01	-1.44E+01	-1.44E+01
<b>Biased Statistics</b>							
Average Biased	-1.44E+01	-1.44E+01	-1.44E+01	-1.44E+01	-1.44E+01	-1.44E+01	-1.44E+01
Std Dev Biased	5.81E-03	6.31E-03	6.54E-03	6.30E-03	6.34E-03	6.54E-03	6.02E-03
Ps99%/90% (+KTL) Biased	-1.44E+01	-1.44E+01	-1.44E+01	-1.44E+01	-1.44E+01	-1.44E+01	-1.44E+01
Ps99%/90% (-KTL) Biased	-1.45E+01	-1.45E+01	-1.45E+01	-1.45E+01	-1.45E+01	-1.45E+01	-1.45E+01
<b>Un-Biased Statistics</b>							
Average Un-Biased	-1.44E+01	-1.44E+01	-1.44E+01	-1.44E+01	-1.44E+01	-1.44E+01	-1.44E+01
Std Dev Un-Biased	6.02E-03	6.42E-03	6.31E-03	6.42E-03	6.63E-03	6.63E-03	6.23E-03
Ps99%/90% (+KTL) Un-Biased	-1.44E+01	-1.44E+01	-1.44E+01	-1.44E+01	-1.44E+01	-1.44E+01	-1.44E+01
Ps99%/90% (-KTL) Un-Biased	-1.45E+01	-1.45E+01	-1.45E+01	-1.45E+01	-1.45E+01	-1.45E+01	-1.45E+01
<b>Specification MAX</b>	<b>-1.25E+01</b>	<b>-1.25E+01</b>	<b>-1.25E+01</b>	<b>-1.25E+01</b>	<b>-1.25E+01</b>	<b>-1.25E+01</b>	<b>-1.25E+01</b>
Status	PASS	PASS	PASS	PASS	PASS	PASS	PASS

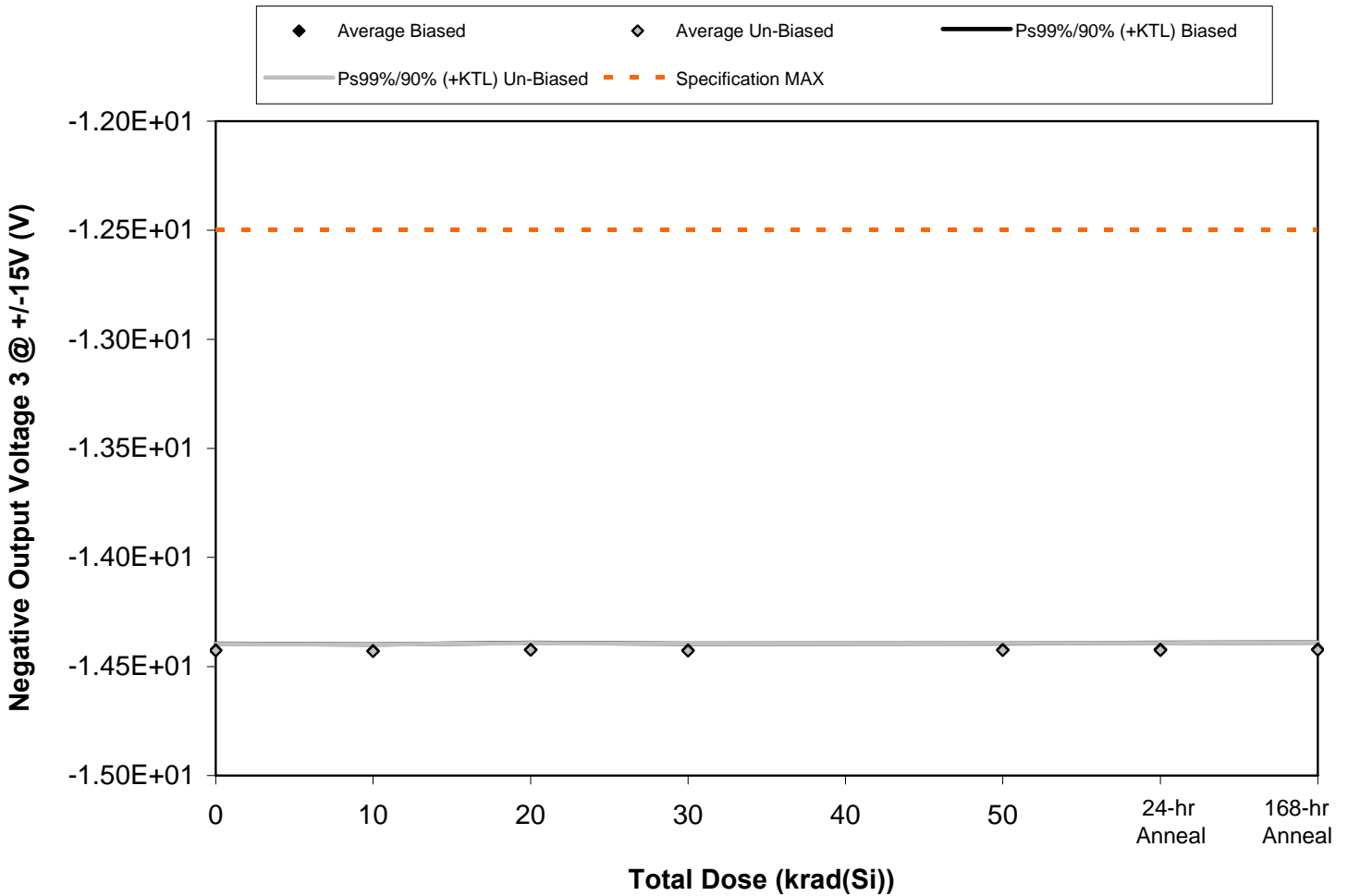

Figure 5.37. Plot of Negative Output Voltage 3 @ +/-15V (V) versus total dose. The data show no significant degradation with radiation. The solid diamonds are the average of measured data points from the biased sample (devices irradiated with an electrical bias) while the shaded diamonds are the average from the unbiased sample. The black lines show the effects on the data after application of the biased KTL statistics (solid and dashed lines) while the gray lines show the effects on the data after application of the unbiased KTL statistics (solid and dashed lines). The red dashed lines are the minimum and maximum specification values as defined in the datasheet and/or test plan.





Table 5.37. Raw data for Negative Output Voltage 3 @ +/-15V (V) versus total dose, including the statistical analysis, the specification and the status of the testing (pass/fail).

Negative Output Voltage 3 @ +/-15V (V)	Total Dose (krad(Si))					24-hr Anneal	168-hr Anneal
	0	10	20	30	50		
Device							
1027	-1.44E+01	-1.44E+01	-1.44E+01	-1.44E+01	-1.44E+01	-1.44E+01	-1.44E+01
1029	-1.44E+01	-1.44E+01	-1.44E+01	-1.44E+01	-1.44E+01	-1.44E+01	-1.44E+01
1030	-1.44E+01	-1.44E+01	-1.44E+01	-1.44E+01	-1.44E+01	-1.44E+01	-1.44E+01
1031	-1.44E+01	-1.44E+01	-1.44E+01	-1.44E+01	-1.44E+01	-1.44E+01	-1.44E+01
1032	-1.44E+01	-1.44E+01	-1.44E+01	-1.44E+01	-1.44E+01	-1.44E+01	-1.44E+01
1033	-1.44E+01	-1.44E+01	-1.44E+01	-1.44E+01	-1.44E+01	-1.44E+01	-1.44E+01
1034	-1.44E+01	-1.44E+01	-1.44E+01	-1.44E+01	-1.44E+01	-1.44E+01	-1.44E+01
1035	-1.44E+01	-1.44E+01	-1.44E+01	-1.44E+01	-1.44E+01	-1.44E+01	-1.44E+01
1036	-1.44E+01	-1.44E+01	-1.44E+01	-1.44E+01	-1.44E+01	-1.44E+01	-1.44E+01
1038	-1.44E+01	-1.44E+01	-1.44E+01	-1.44E+01	-1.44E+01	-1.44E+01	-1.44E+01
1039	-1.44E+01	-1.44E+01	-1.44E+01	-1.44E+01	-1.44E+01	-1.44E+01	-1.44E+01
<b>Biased Statistics</b>							
Average Biased	-1.44E+01	-1.44E+01	-1.44E+01	-1.44E+01	-1.44E+01	-1.44E+01	-1.44E+01
Std Dev Biased	6.39E-03	6.43E-03	6.65E-03	6.39E-03	6.15E-03	6.44E-03	6.34E-03
Ps99%/90% (+KTL) Biased	-1.44E+01	-1.44E+01	-1.44E+01	-1.44E+01	-1.44E+01	-1.44E+01	-1.44E+01
Ps99%/90% (-KTL) Biased	-1.45E+01	-1.45E+01	-1.45E+01	-1.45E+01	-1.45E+01	-1.45E+01	-1.44E+01
<b>Un-Biased Statistics</b>							
Average Un-Biased	-1.44E+01	-1.44E+01	-1.44E+01	-1.44E+01	-1.44E+01	-1.44E+01	-1.44E+01
Std Dev Un-Biased	6.54E-03	6.72E-03	6.84E-03	6.87E-03	7.02E-03	7.13E-03	7.22E-03
Ps99%/90% (+KTL) Un-Biased	-1.44E+01	-1.44E+01	-1.44E+01	-1.44E+01	-1.44E+01	-1.44E+01	-1.44E+01
Ps99%/90% (-KTL) Un-Biased	-1.45E+01	-1.45E+01	-1.45E+01	-1.45E+01	-1.45E+01	-1.45E+01	-1.45E+01
<b>Specification MAX</b>	<b>-1.25E+01</b>	<b>-1.25E+01</b>	<b>-1.25E+01</b>	<b>-1.25E+01</b>	<b>-1.25E+01</b>	<b>-1.25E+01</b>	<b>-1.25E+01</b>
Status	PASS	PASS	PASS	PASS	PASS	PASS	PASS

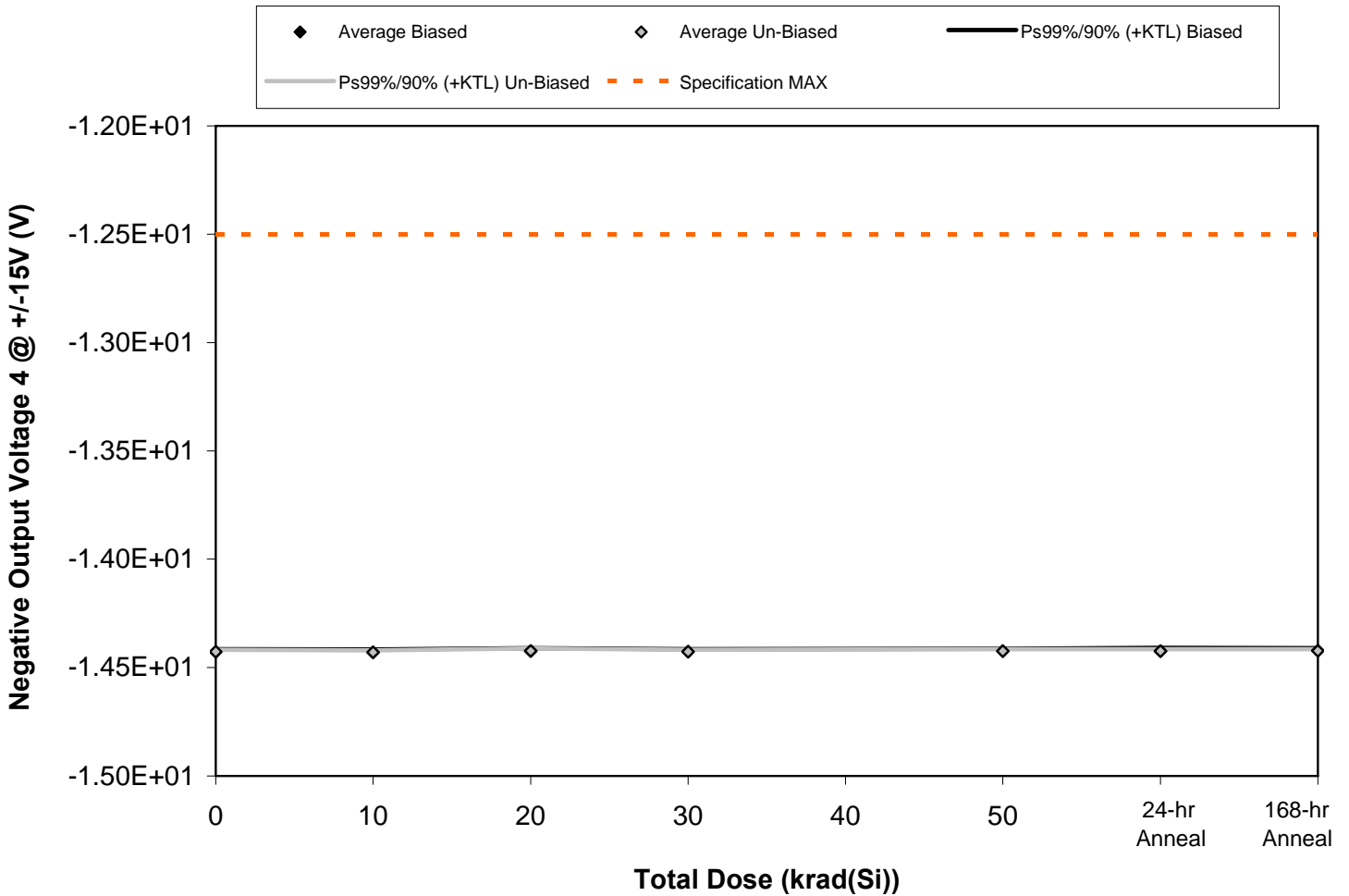

Figure 5.38. Plot of Negative Output Voltage 4 @ +/-15V (V) versus total dose. The data show no significant degradation with radiation. The solid diamonds are the average of measured data points from the biased sample (devices irradiated with an electrical bias) while the shaded diamonds are the average from the unbiased sample. The black lines show the effects on the data after application of the biased KTL statistics (solid and dashed lines) while the gray lines show the effects on the data after application of the unbiased KTL statistics (solid and dashed lines). The red dashed lines are the minimum and maximum specification values as defined in the datasheet and/or test plan.



Table 5.38. Raw data for Negative Output Voltage 4 @ +/-15V (V) versus total dose, including the statistical analysis, the specification and the status of the testing (pass/fail).

Negative Output Voltage 4 @ +/-15V (V)	Total Dose (krad(Si))					24-hr Anneal	168-hr Anneal
	0	10	20	30	50		
Device							
1027	-1.44E+01	-1.44E+01	-1.44E+01	-1.44E+01	-1.44E+01	-1.44E+01	-1.44E+01
1029	-1.44E+01	-1.44E+01	-1.44E+01	-1.44E+01	-1.44E+01	-1.44E+01	-1.44E+01
1030	-1.44E+01	-1.44E+01	-1.44E+01	-1.44E+01	-1.44E+01	-1.44E+01	-1.44E+01
1031	-1.44E+01	-1.44E+01	-1.44E+01	-1.44E+01	-1.44E+01	-1.44E+01	-1.44E+01
1032	-1.44E+01	-1.44E+01	-1.44E+01	-1.44E+01	-1.44E+01	-1.44E+01	-1.44E+01
1033	-1.44E+01	-1.44E+01	-1.44E+01	-1.44E+01	-1.44E+01	-1.44E+01	-1.44E+01
1034	-1.44E+01	-1.44E+01	-1.44E+01	-1.44E+01	-1.44E+01	-1.44E+01	-1.44E+01
1035	-1.44E+01	-1.44E+01	-1.44E+01	-1.44E+01	-1.44E+01	-1.44E+01	-1.44E+01
1036	-1.44E+01	-1.44E+01	-1.44E+01	-1.44E+01	-1.44E+01	-1.44E+01	-1.44E+01
1038	-1.44E+01	-1.44E+01	-1.44E+01	-1.44E+01	-1.44E+01	-1.44E+01	-1.44E+01
1039	-1.44E+01	-1.44E+01	-1.44E+01	-1.44E+01	-1.44E+01	-1.44E+01	-1.44E+01
<b>Biased Statistics</b>							
Average Biased	-1.44E+01	-1.44E+01	-1.44E+01	-1.44E+01	-1.44E+01	-1.44E+01	-1.44E+01
Std Dev Biased	2.61E-03	2.86E-03	2.97E-03	2.49E-03	2.49E-03	3.11E-03	2.45E-03
Ps99%/90% (+KTL) Biased	-1.44E+01	-1.44E+01	-1.44E+01	-1.44E+01	-1.44E+01	-1.44E+01	-1.44E+01
Ps99%/90% (-KTL) Biased	-1.44E+01	-1.44E+01	-1.44E+01	-1.44E+01	-1.44E+01	-1.44E+01	-1.44E+01
<b>Un-Biased Statistics</b>							
Average Un-Biased	-1.44E+01	-1.44E+01	-1.44E+01	-1.44E+01	-1.44E+01	-1.44E+01	-1.44E+01
Std Dev Un-Biased	1.79E-03	1.79E-03	2.51E-03	1.79E-03	1.79E-03	1.79E-03	1.79E-03
Ps99%/90% (+KTL) Un-Biased	-1.44E+01	-1.44E+01	-1.44E+01	-1.44E+01	-1.44E+01	-1.44E+01	-1.44E+01
Ps99%/90% (-KTL) Un-Biased	-1.44E+01	-1.44E+01	-1.44E+01	-1.44E+01	-1.44E+01	-1.44E+01	-1.44E+01
<b>Specification MAX</b>	<b>-1.25E+01</b>	<b>-1.25E+01</b>	<b>-1.25E+01</b>	<b>-1.25E+01</b>	<b>-1.25E+01</b>	<b>-1.25E+01</b>	<b>-1.25E+01</b>
Status	PASS	PASS	PASS	PASS	PASS	PASS	PASS

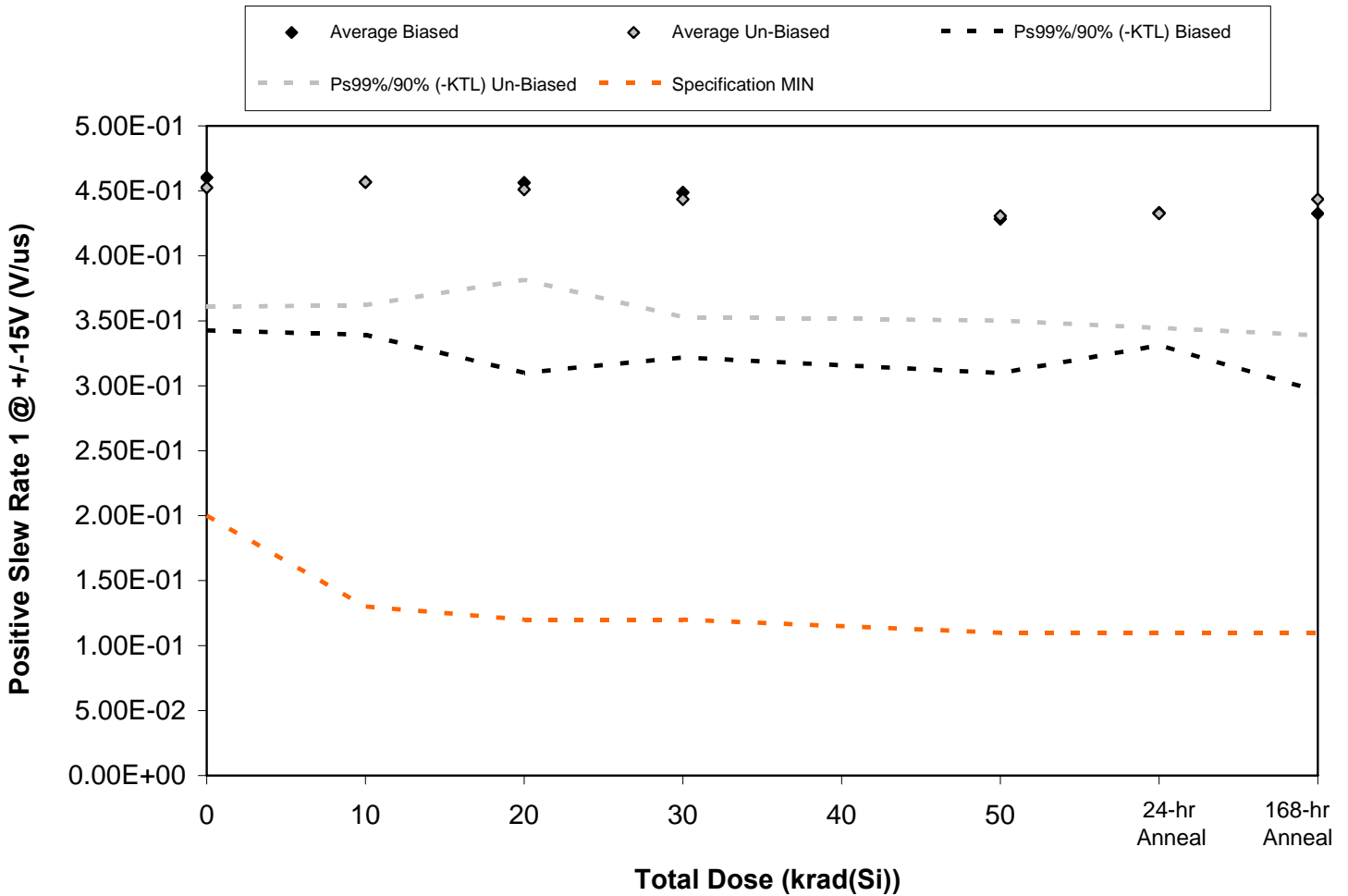

Figure 5.39. Plot of Positive Slew Rate 1 @ +/-15V (V/us) versus total dose. The data show no significant degradation with radiation. The solid diamonds are the average of measured data points from the biased sample (devices irradiated with an electrical bias) while the shaded diamonds are the average from the unbiased sample. The black lines show the effects on the data after application of the biased KTL statistics (solid and dashed lines) while the gray lines show the effects on the data after application of the unbiased KTL statistics (solid and dashed lines). The red dashed lines are the minimum and maximum specification values as defined in the datasheet and/or test plan.



Table 5.39. Raw data for Positive Slew Rate 1 @ +/-15V (V/us) versus total dose, including the statistical analysis, the specification and the status of the testing (pass/fail).

Positive Slew Rate 1 @ +/-15V (V/us)	Total Dose (krad(Si))					24-hr Anneal	168-hr Anneal
	0	10	20	30	50		
Device							
1027	4.97E-01	4.94E-01	4.99E-01	4.84E-01	4.66E-01	4.62E-01	4.75E-01
1029	4.53E-01	4.49E-01	4.31E-01	4.43E-01	4.14E-01	4.26E-01	4.24E-01
1030	4.38E-01	4.33E-01	4.31E-01	4.19E-01	4.03E-01	4.11E-01	4.03E-01
1031	4.74E-01	4.70E-01	4.80E-01	4.69E-01	4.42E-01	4.50E-01	4.49E-01
1032	4.39E-01	4.38E-01	4.40E-01	4.29E-01	4.17E-01	4.17E-01	4.12E-01
1033	4.19E-01	4.25E-01	4.26E-01	4.12E-01	4.03E-01	4.04E-01	4.08E-01
1034	4.60E-01	4.69E-01	4.57E-01	4.50E-01	4.36E-01	4.43E-01	4.45E-01
1035	4.51E-01	4.48E-01	4.49E-01	4.39E-01	4.26E-01	4.23E-01	4.39E-01
1036	4.67E-01	4.73E-01	4.62E-01	4.54E-01	4.41E-01	4.43E-01	4.61E-01
1038	4.65E-01	4.69E-01	4.61E-01	4.62E-01	4.47E-01	4.50E-01	4.64E-01
1039	4.74E-01	4.78E-01	4.74E-01	4.90E-01	4.66E-01	4.77E-01	4.76E-01
<b>Biased Statistics</b>							
Average Biased	4.60E-01	4.57E-01	4.56E-01	4.49E-01	4.28E-01	4.33E-01	4.33E-01
Std Dev Biased	2.52E-02	2.52E-02	3.13E-02	2.72E-02	2.54E-02	2.19E-02	2.93E-02
Ps99%/90% (+KTL) Biased	5.78E-01	5.74E-01	6.02E-01	5.76E-01	5.47E-01	5.35E-01	5.69E-01
Ps99%/90% (-KTL) Biased	3.43E-01	3.39E-01	3.10E-01	3.22E-01	3.10E-01	3.31E-01	2.96E-01
<b>Un-Biased Statistics</b>							
Average Un-Biased	4.52E-01	4.57E-01	4.51E-01	4.43E-01	4.31E-01	4.33E-01	4.43E-01
Std Dev Un-Biased	1.97E-02	2.03E-02	1.49E-02	1.94E-02	1.72E-02	1.89E-02	2.24E-02
Ps99%/90% (+KTL) Un-Biased	5.44E-01	5.52E-01	5.20E-01	5.34E-01	5.11E-01	5.21E-01	5.48E-01
Ps99%/90% (-KTL) Un-Biased	3.61E-01	3.62E-01	3.82E-01	3.53E-01	3.50E-01	3.44E-01	3.39E-01
<b>Specification MIN</b>	<b>2.00E-01</b>	<b>1.30E-01</b>	<b>1.20E-01</b>	<b>1.20E-01</b>	<b>1.10E-01</b>	<b>1.10E-01</b>	<b>1.10E-01</b>
Status	PASS	PASS	PASS	PASS	PASS	PASS	PASS

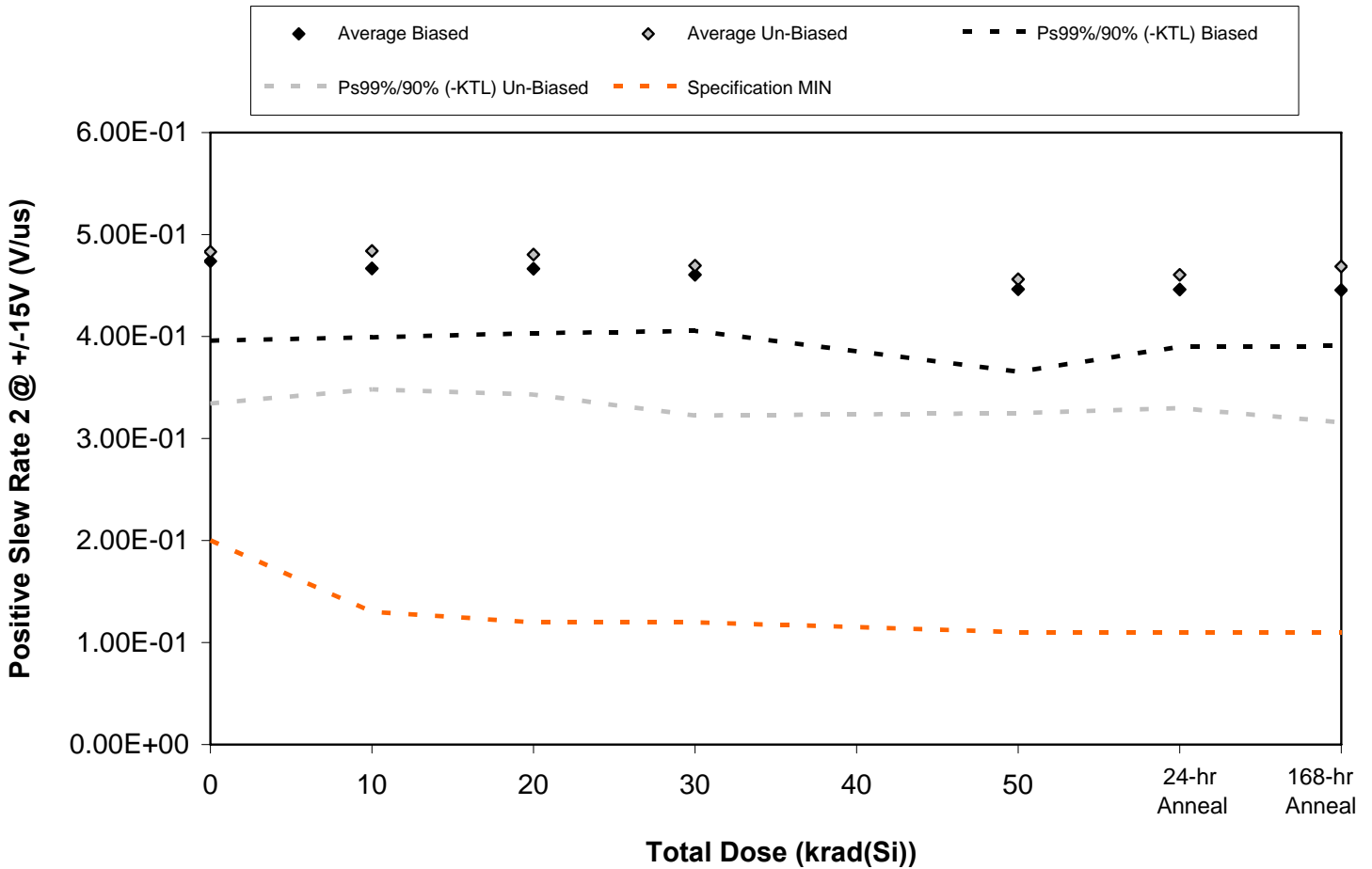

Figure 5.40. Plot of Positive Slew Rate 2 @ +/-15V (V/us) versus total dose. The data show no significant degradation with radiation. The solid diamonds are the average of measured data points from the biased sample (devices irradiated with an electrical bias) while the shaded diamonds are the average from the unbiased sample. The black lines show the effects on the data after application of the biased KTL statistics (solid and dashed lines) while the gray lines show the effects on the data after application of the unbiased KTL statistics (solid and dashed lines). The red dashed lines are the minimum and maximum specification values as defined in the datasheet and/or test plan.



Table 5.40. Raw data for Positive Slew Rate 2 @ +/-15V (V/us) versus total dose, including the statistical analysis, the specification and the status of the testing (pass/fail).

Positive Slew Rate 2 @ +/-15V (V/us)	Total Dose (krad(Si))					24-hr Anneal	168-hr Anneal
	0	10	20	30	50		
Device							
1027	4.83E-01	4.74E-01	4.67E-01	4.61E-01	4.53E-01	4.54E-01	4.50E-01
1029	4.84E-01	4.71E-01	4.77E-01	4.65E-01	4.49E-01	4.50E-01	4.44E-01
1030	4.88E-01	4.83E-01	4.79E-01	4.76E-01	4.69E-01	4.57E-01	4.63E-01
1031	4.48E-01	4.45E-01	4.45E-01	4.44E-01	4.23E-01	4.27E-01	4.32E-01
1032	4.66E-01	4.61E-01	4.64E-01	4.56E-01	4.37E-01	4.42E-01	4.39E-01
1033	4.73E-01	4.71E-01	4.72E-01	4.62E-01	4.45E-01	4.59E-01	4.56E-01
1034	5.21E-01	5.18E-01	5.19E-01	5.12E-01	4.89E-01	4.93E-01	5.11E-01
1035	5.11E-01	5.12E-01	5.03E-01	4.89E-01	4.83E-01	4.84E-01	4.95E-01
1036	4.64E-01	4.62E-01	4.55E-01	4.52E-01	4.35E-01	4.40E-01	4.46E-01
1038	4.46E-01	4.56E-01	4.53E-01	4.32E-01	4.28E-01	4.27E-01	4.35E-01
1039	5.36E-01	5.43E-01	5.38E-01	5.34E-01	5.38E-01	5.28E-01	5.28E-01
<b>Biased Statistics</b>							
Average Biased	4.74E-01	4.67E-01	4.66E-01	4.60E-01	4.46E-01	4.46E-01	4.46E-01
Std Dev Biased	1.67E-02	1.45E-02	1.36E-02	1.18E-02	1.73E-02	1.20E-02	1.18E-02
Ps99%/90% (+KTL) Biased	5.52E-01	5.34E-01	5.30E-01	5.15E-01	5.27E-01	5.02E-01	5.00E-01
Ps99%/90% (-KTL) Biased	3.96E-01	3.99E-01	4.03E-01	4.06E-01	3.65E-01	3.90E-01	3.91E-01
<b>Un-Biased Statistics</b>							
Average Un-Biased	4.83E-01	4.84E-01	4.80E-01	4.69E-01	4.56E-01	4.61E-01	4.69E-01
Std Dev Un-Biased	3.19E-02	2.91E-02	2.94E-02	3.14E-02	2.81E-02	2.81E-02	3.28E-02
Ps99%/90% (+KTL) Un-Biased	6.32E-01	6.19E-01	6.18E-01	6.16E-01	5.87E-01	5.92E-01	6.21E-01
Ps99%/90% (-KTL) Un-Biased	3.34E-01	3.48E-01	3.43E-01	3.23E-01	3.25E-01	3.30E-01	3.16E-01
<b>Specification MIN</b>	<b>2.00E-01</b>	<b>1.30E-01</b>	<b>1.20E-01</b>	<b>1.20E-01</b>	<b>1.10E-01</b>	<b>1.10E-01</b>	<b>1.10E-01</b>
Status	PASS	PASS	PASS	PASS	PASS	PASS	PASS

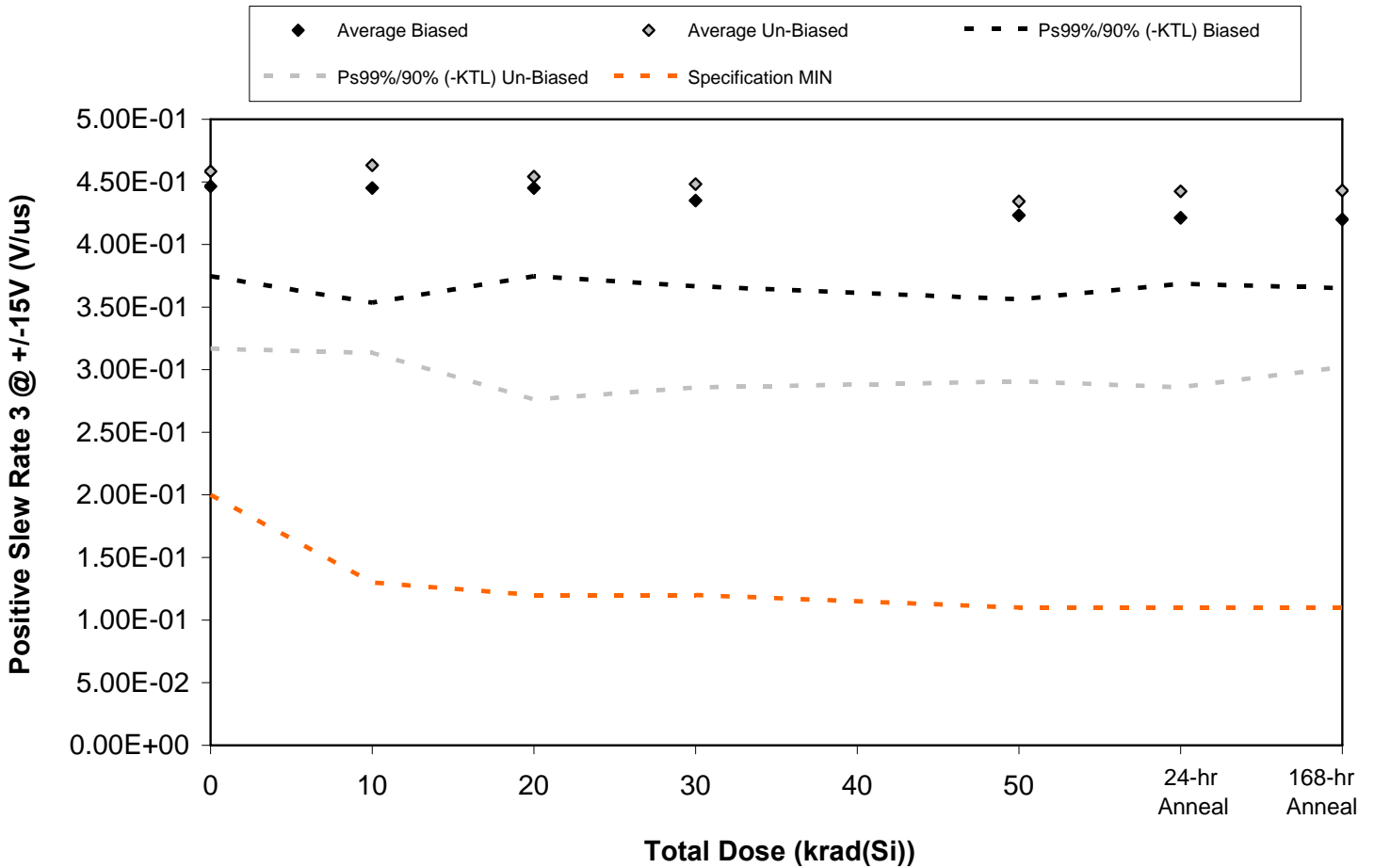

Figure 5.41. Plot of Positive Slew Rate 3 @ +/-15V (V/us) versus total dose. The data show no significant degradation with radiation. The solid diamonds are the average of measured data points from the biased sample (devices irradiated with an electrical bias) while the shaded diamonds are the average from the unbiased sample. The black lines show the effects on the data after application of the biased KTL statistics (solid and dashed lines) while the gray lines show the effects on the data after application of the unbiased KTL statistics (solid and dashed lines). The red dashed lines are the minimum and maximum specification values as defined in the datasheet and/or test plan.





Table 5.41. Raw data for Positive Slew Rate 3 @ +/-15V (V/us) versus total dose, including the statistical analysis, the specification and the status of the testing (pass/fail).

Positive Slew Rate 3 @ +/-15V (V/us)	Total Dose (krad(Si))					24-hr Anneal	168-hr Anneal
	0	10	20	30	50		
Device							
1027	4.50E-01	4.54E-01	4.50E-01	4.45E-01	4.31E-01	4.23E-01	4.26E-01
1029	4.45E-01	4.51E-01	4.55E-01	4.41E-01	4.25E-01	4.29E-01	4.26E-01
1030	4.70E-01	4.70E-01	4.59E-01	4.49E-01	4.41E-01	4.33E-01	4.32E-01
1031	4.29E-01	4.21E-01	4.21E-01	4.13E-01	4.03E-01	4.04E-01	4.03E-01
1032	4.38E-01	4.30E-01	4.41E-01	4.28E-01	4.17E-01	4.18E-01	4.13E-01
1033	4.48E-01	4.48E-01	4.44E-01	4.29E-01	4.22E-01	4.34E-01	4.35E-01
1034	5.02E-01	5.09E-01	5.12E-01	4.97E-01	4.79E-01	4.94E-01	4.88E-01
1035	4.76E-01	4.85E-01	4.71E-01	4.73E-01	4.53E-01	4.55E-01	4.57E-01
1036	4.39E-01	4.40E-01	4.25E-01	4.23E-01	4.12E-01	4.19E-01	4.23E-01
1038	4.27E-01	4.35E-01	4.19E-01	4.19E-01	4.06E-01	4.10E-01	4.12E-01
1039	4.94E-01	5.11E-01	5.00E-01	5.03E-01	5.03E-01	5.01E-01	5.11E-01
<b>Biased Statistics</b>							
Average Biased	4.46E-01	4.45E-01	4.45E-01	4.35E-01	4.23E-01	4.21E-01	4.20E-01
Std Dev Biased	1.54E-02	1.96E-02	1.51E-02	1.47E-02	1.44E-02	1.13E-02	1.18E-02
Ps99%/90% (+KTL) Biased	5.18E-01	5.37E-01	5.16E-01	5.04E-01	4.90E-01	4.74E-01	4.75E-01
Ps99%/90% (-KTL) Biased	3.75E-01	3.54E-01	3.75E-01	3.67E-01	3.56E-01	3.69E-01	3.65E-01
<b>Un-Biased Statistics</b>							
Average Un-Biased	4.58E-01	4.63E-01	4.54E-01	4.48E-01	4.34E-01	4.42E-01	4.43E-01
Std Dev Un-Biased	3.03E-02	3.22E-02	3.81E-02	3.48E-02	3.08E-02	3.35E-02	3.02E-02
Ps99%/90% (+KTL) Un-Biased	6.00E-01	6.13E-01	6.32E-01	6.11E-01	5.78E-01	5.99E-01	5.84E-01
Ps99%/90% (-KTL) Un-Biased	3.17E-01	3.13E-01	2.76E-01	2.86E-01	2.91E-01	2.86E-01	3.02E-01
<b>Specification MIN</b>	<b>2.00E-01</b>	<b>1.30E-01</b>	<b>1.20E-01</b>	<b>1.20E-01</b>	<b>1.10E-01</b>	<b>1.10E-01</b>	<b>1.10E-01</b>
Status	PASS	PASS	PASS	PASS	PASS	PASS	PASS

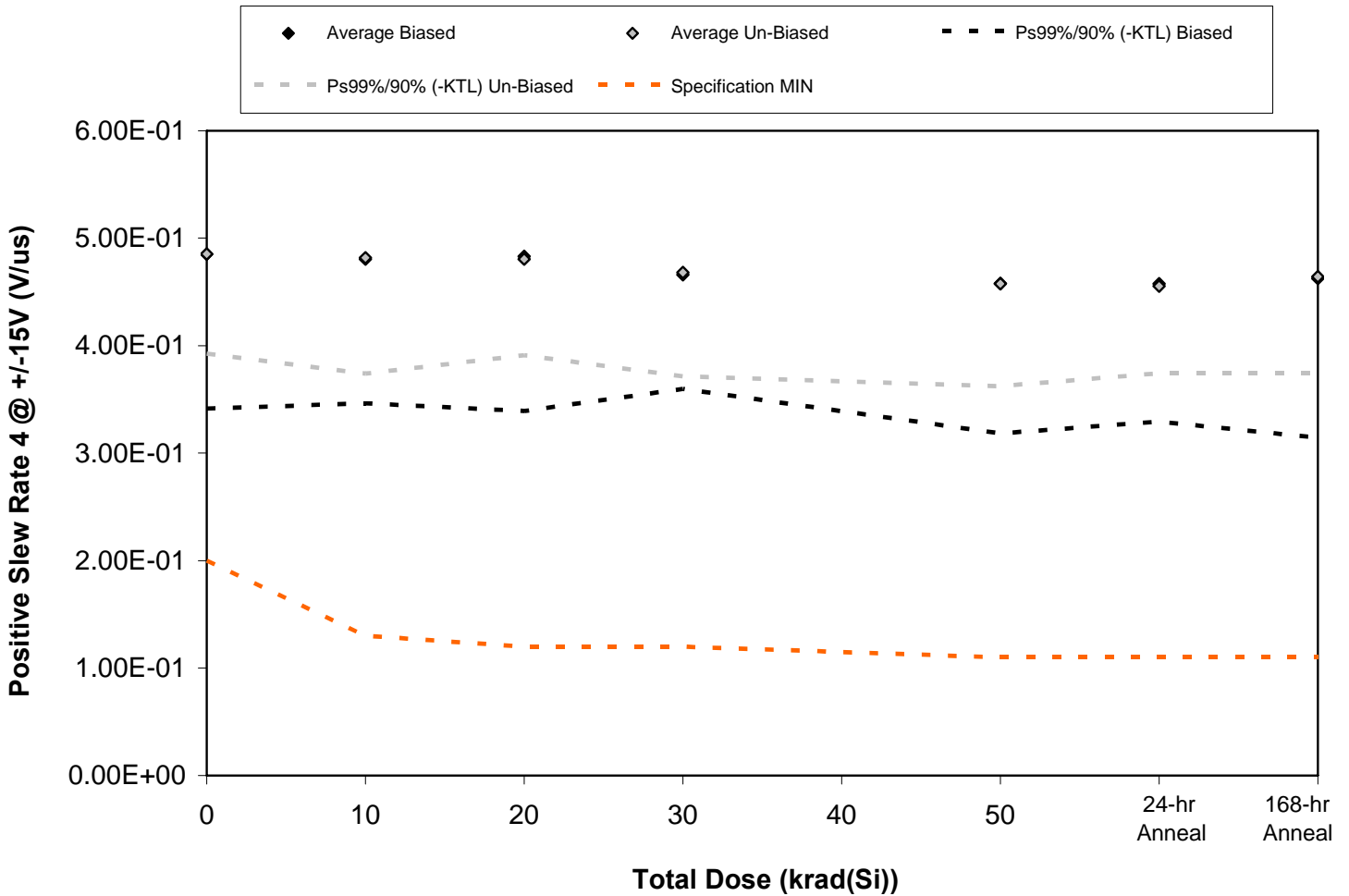

Figure 5.42. Plot of Positive Slew Rate 4 @ +/-15V (V/us) versus total dose. The data show no significant degradation with radiation. The solid diamonds are the average of measured data points from the biased sample (devices irradiated with an electrical bias) while the shaded diamonds are the average from the unbiased sample. The black lines show the effects on the data after application of the biased KTL statistics (solid and dashed lines) while the gray lines show the effects on the data after application of the unbiased KTL statistics (solid and dashed lines). The red dashed lines are the minimum and maximum specification values as defined in the datasheet and/or test plan.



Table 5.42. Raw data for Positive Slew Rate 4 @ +/-15V (V/us) versus total dose, including the statistical analysis, the specification and the status of the testing (pass/fail).

Positive Slew Rate 4 @ +/-15V (V/us)	Total Dose (krad(Si))					24-hr Anneal	168-hr Anneal
	0	10	20	30	50		
Device							
1027	5.33E-01	5.28E-01	5.32E-01	4.94E-01	5.01E-01	4.99E-01	5.08E-01
1029	4.63E-01	4.59E-01	4.64E-01	4.57E-01	4.43E-01	4.43E-01	4.40E-01
1030	4.61E-01	4.60E-01	4.62E-01	4.42E-01	4.30E-01	4.31E-01	4.35E-01
1031	4.99E-01	4.87E-01	4.96E-01	4.86E-01	4.77E-01	4.72E-01	4.83E-01
1032	4.70E-01	4.69E-01	4.62E-01	4.51E-01	4.39E-01	4.44E-01	4.46E-01
1033	4.52E-01	4.45E-01	4.49E-01	4.35E-01	4.25E-01	4.25E-01	4.34E-01
1034	4.97E-01	4.85E-01	4.90E-01	4.73E-01	4.57E-01	4.64E-01	4.67E-01
1035	4.82E-01	4.77E-01	4.77E-01	4.63E-01	4.57E-01	4.58E-01	4.59E-01
1036	4.98E-01	5.03E-01	4.98E-01	4.86E-01	4.75E-01	4.62E-01	4.79E-01
1038	4.98E-01	4.99E-01	4.89E-01	4.84E-01	4.75E-01	4.68E-01	4.82E-01
1039	4.96E-01	5.00E-01	5.11E-01	4.98E-01	4.95E-01	5.00E-01	5.00E-01
<b>Biased Statistics</b>							
Average Biased	4.85E-01	4.81E-01	4.83E-01	4.66E-01	4.58E-01	4.58E-01	4.62E-01
Std Dev Biased	3.08E-02	2.88E-02	3.09E-02	2.27E-02	2.99E-02	2.75E-02	3.17E-02
Ps99%/90% (+KTL) Biased	6.29E-01	6.15E-01	6.27E-01	5.72E-01	5.98E-01	5.86E-01	6.10E-01
Ps99%/90% (-KTL) Biased	3.42E-01	3.46E-01	3.39E-01	3.60E-01	3.18E-01	3.29E-01	3.14E-01
<b>Un-Biased Statistics</b>							
Average Un-Biased	4.85E-01	4.82E-01	4.81E-01	4.68E-01	4.58E-01	4.55E-01	4.64E-01
Std Dev Un-Biased	1.99E-02	2.31E-02	1.92E-02	2.07E-02	2.04E-02	1.74E-02	1.93E-02
Ps99%/90% (+KTL) Un-Biased	5.78E-01	5.90E-01	5.70E-01	5.65E-01	5.53E-01	5.36E-01	5.54E-01
Ps99%/90% (-KTL) Un-Biased	3.93E-01	3.74E-01	3.91E-01	3.71E-01	3.62E-01	3.74E-01	3.74E-01
<b>Specification MIN</b>	<b>2.00E-01</b>	<b>1.30E-01</b>	<b>1.20E-01</b>	<b>1.20E-01</b>	<b>1.10E-01</b>	<b>1.10E-01</b>	<b>1.10E-01</b>
Status	PASS	PASS	PASS	PASS	PASS	PASS	PASS

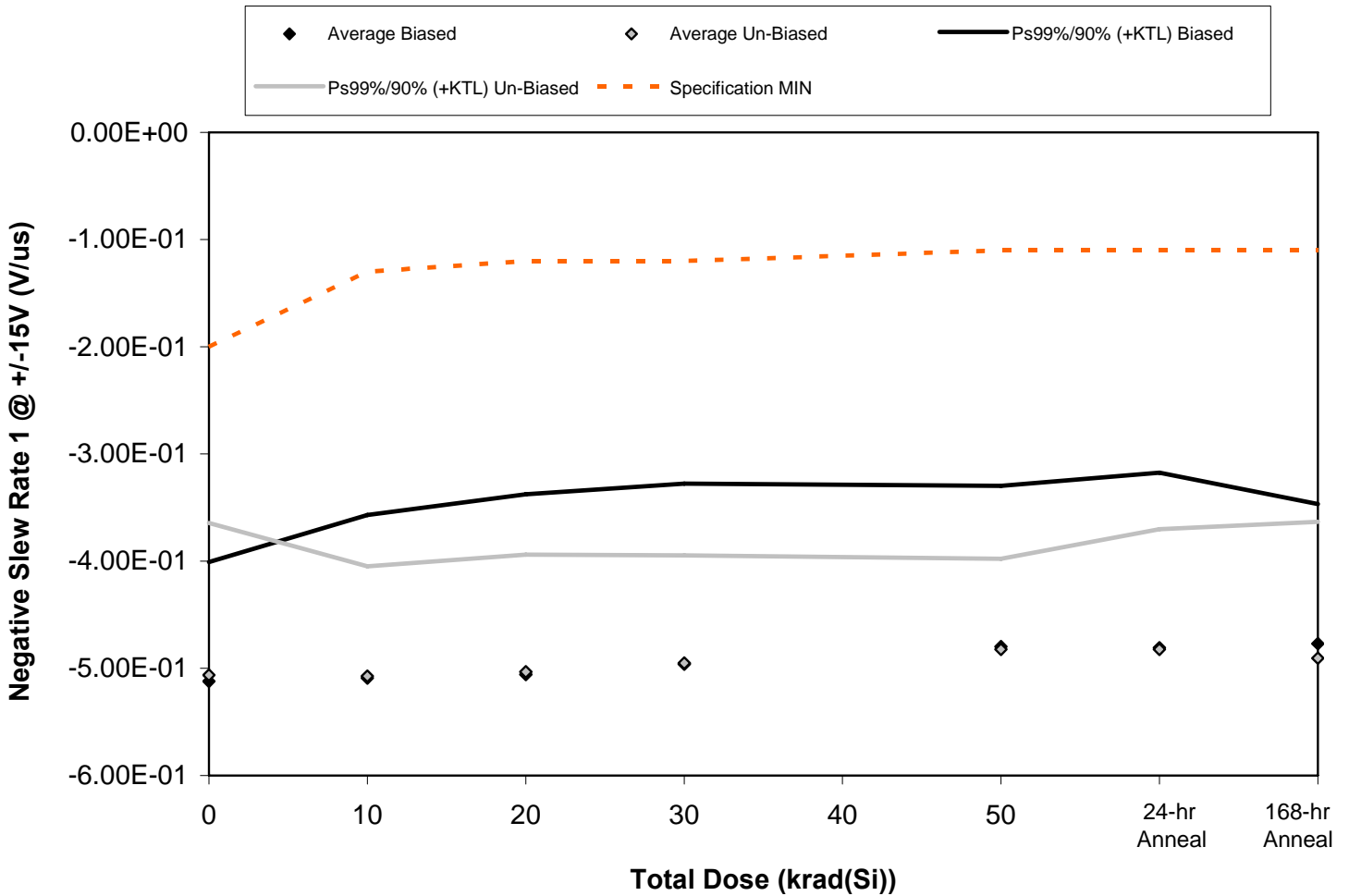

Figure 5.43. Plot of Negative Slew Rate 1 @ +/-15V (V/us) versus total dose. The data show no significant degradation with radiation. The solid diamonds are the average of measured data points from the biased sample (devices irradiated with an electrical bias) while the shaded diamonds are the average from the unbiased sample. The black lines show the effects on the data after application of the biased KTL statistics (solid and dashed lines) while the gray lines show the effects on the data after application of the unbiased KTL statistics (solid and dashed lines). The red dashed lines are the minimum and maximum specification values as defined in the datasheet and/or test plan.



Table 5.43. Raw data for Negative Slew Rate 1 @ +/-15V (V/us) versus total dose, including the statistical analysis, the specification and the status of the testing (pass/fail).

Negative Slew Rate 1 @ +/-15V (V/us)	Total Dose (krad(Si))					24-hr Anneal	168-hr Anneal
	0	10	20	30	50		
Device							
1027	-5.47E-01	-5.57E-01	-5.61E-01	-5.45E-01	-5.24E-01	-5.12E-01	-5.15E-01
1029	-5.07E-01	-4.94E-01	-4.85E-01	-4.79E-01	-4.76E-01	-4.64E-01	-4.64E-01
1030	-4.90E-01	-4.84E-01	-4.71E-01	-4.62E-01	-4.39E-01	-4.44E-01	-4.54E-01
1031	-5.24E-01	-5.28E-01	-5.22E-01	-5.23E-01	-4.96E-01	-5.24E-01	-4.98E-01
1032	-4.92E-01	-4.82E-01	-4.90E-01	-4.71E-01	-4.64E-01	-4.60E-01	-4.54E-01
1033	-4.61E-01	-4.70E-01	-4.62E-01	-4.60E-01	-4.52E-01	-4.44E-01	-4.42E-01
1034	-5.19E-01	-5.18E-01	-5.20E-01	-4.97E-01	-4.96E-01	-4.96E-01	-5.06E-01
1035	-4.91E-01	-5.05E-01	-5.08E-01	-4.93E-01	-4.80E-01	-4.74E-01	-5.00E-01
1036	-5.22E-01	-5.19E-01	-5.13E-01	-5.12E-01	-4.95E-01	-5.04E-01	-5.05E-01
1038	-5.38E-01	-5.24E-01	-5.13E-01	-5.13E-01	-4.89E-01	-4.93E-01	-4.99E-01
1039	-5.27E-01	-5.43E-01	-5.46E-01	-5.28E-01	-5.30E-01	-5.29E-01	-5.35E-01
<b>Biased Statistics</b>							
Average Biased	-5.12E-01	-5.09E-01	-5.06E-01	-4.96E-01	-4.80E-01	-4.81E-01	-4.77E-01
Std Dev Biased	2.39E-02	3.26E-02	3.61E-02	3.61E-02	3.22E-02	3.50E-02	2.79E-02
Ps99%/90% (+KTL) Biased	-4.01E-01	-3.57E-01	-3.38E-01	-3.28E-01	-3.30E-01	-3.17E-01	-3.47E-01
Ps99%/90% (-KTL) Biased	-6.23E-01	-6.61E-01	-6.74E-01	-6.64E-01	-6.30E-01	-6.44E-01	-6.07E-01
<b>Un-Biased Statistics</b>							
Average Un-Biased	-5.06E-01	-5.07E-01	-5.03E-01	-4.95E-01	-4.82E-01	-4.82E-01	-4.90E-01
Std Dev Un-Biased	3.04E-02	2.19E-02	2.34E-02	2.15E-02	1.81E-02	2.40E-02	2.72E-02
Ps99%/90% (+KTL) Un-Biased	-3.64E-01	-4.05E-01	-3.94E-01	-3.95E-01	-3.98E-01	-3.70E-01	-3.63E-01
Ps99%/90% (-KTL) Un-Biased	-6.48E-01	-6.10E-01	-6.12E-01	-5.95E-01	-5.67E-01	-5.94E-01	-6.17E-01
<b>Specification MIN</b>	<b>-2.00E-01</b>	<b>-1.30E-01</b>	<b>-1.20E-01</b>	<b>-1.20E-01</b>	<b>-1.10E-01</b>	<b>-1.10E-01</b>	<b>-1.10E-01</b>
Status	PASS	PASS	PASS	PASS	PASS	PASS	PASS

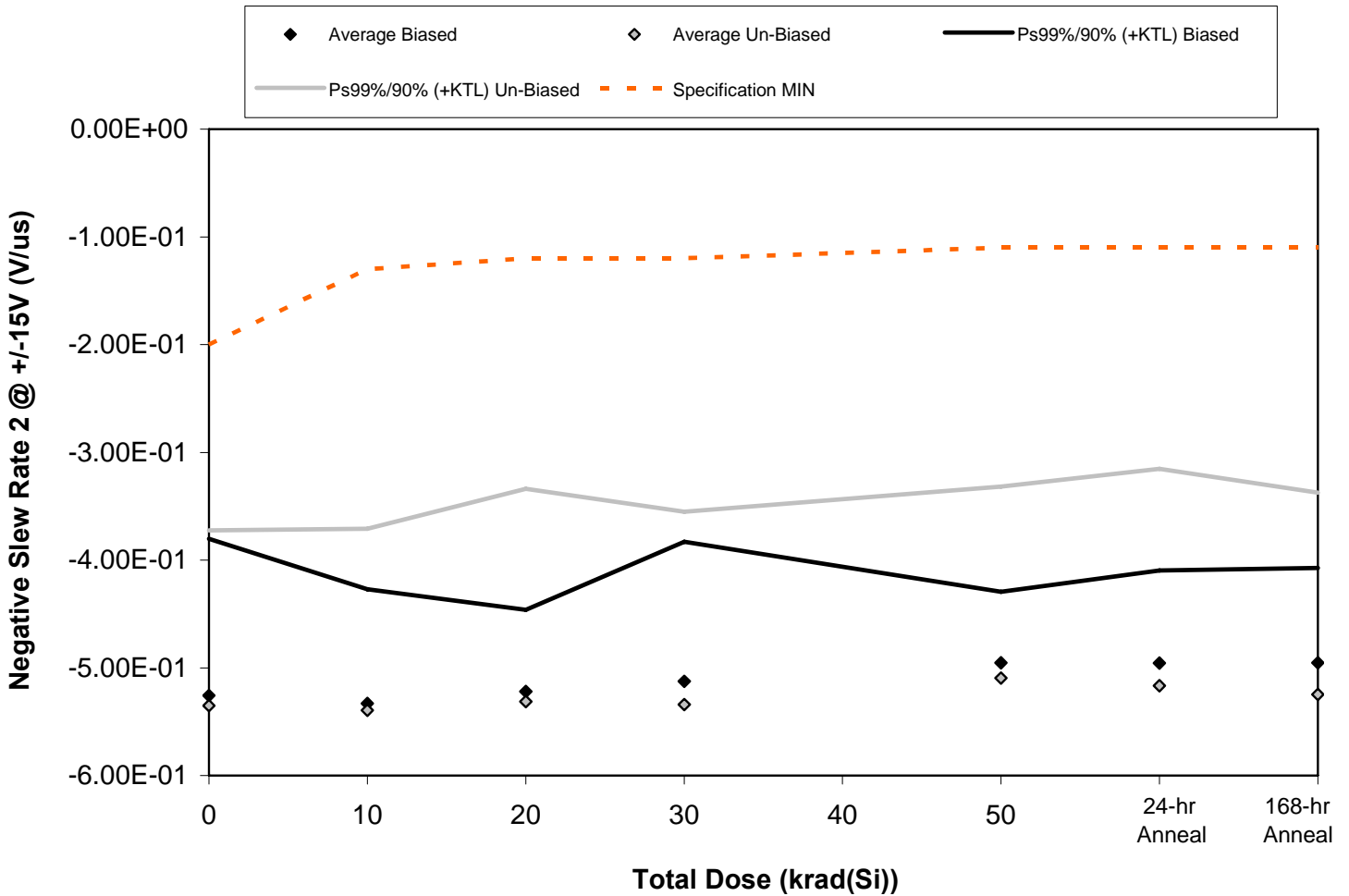

Figure 5.44. Plot of Negative Slew Rate 2 @ +/-15V (V/us) versus total dose. The data show no significant degradation with radiation. The solid diamonds are the average of measured data points from the biased sample (devices irradiated with an electrical bias) while the shaded diamonds are the average from the unbiased sample. The black lines show the effects on the data after application of the biased KTL statistics (solid and dashed lines) while the gray lines show the effects on the data after application of the unbiased KTL statistics (solid and dashed lines). The red dashed lines are the minimum and maximum specification values as defined in the datasheet and/or test plan.



Table 5.44. Raw data for Negative Slew Rate 2 @ +/-15V (V/us) versus total dose, including the statistical analysis, the specification and the status of the testing (pass/fail).

Negative Slew Rate 2 @ +/-15V (V/us)	Total Dose (krad(Si))					24-hr Anneal	168-hr Anneal
	0	10	20	30	50		
Device							
1027	-5.37E-01	-5.52E-01	-5.22E-01	-5.13E-01	-5.02E-01	-5.02E-01	-4.95E-01
1029	-5.26E-01	-5.38E-01	-5.30E-01	-5.15E-01	-4.88E-01	-5.00E-01	-5.09E-01
1030	-5.67E-01	-5.54E-01	-5.38E-01	-5.53E-01	-5.16E-01	-5.18E-01	-5.13E-01
1031	-4.81E-01	-5.00E-01	-4.95E-01	-4.75E-01	-4.79E-01	-4.68E-01	-4.65E-01
1032	-5.18E-01	-5.21E-01	-5.25E-01	-5.07E-01	-4.92E-01	-4.90E-01	-4.94E-01
1033	-5.32E-01	-5.31E-01	-5.16E-01	-5.22E-01	-5.02E-01	-5.03E-01	-5.17E-01
1034	-5.82E-01	-5.83E-01	-5.93E-01	-5.83E-01	-5.60E-01	-5.85E-01	-5.86E-01
1035	-5.56E-01	-5.70E-01	-5.55E-01	-5.64E-01	-5.36E-01	-5.29E-01	-5.40E-01
1036	-4.94E-01	-5.15E-01	-5.05E-01	-5.10E-01	-4.79E-01	-4.92E-01	-4.96E-01
1038	-5.12E-01	-4.98E-01	-4.88E-01	-4.91E-01	-4.70E-01	-4.74E-01	-4.85E-01
1039	-5.99E-01	-6.13E-01	-5.84E-01	-5.95E-01	-5.90E-01	-6.10E-01	-6.02E-01
<b>Biased Statistics</b>							
Average Biased	-5.26E-01	-5.33E-01	-5.22E-01	-5.13E-01	-4.95E-01	-4.96E-01	-4.95E-01
Std Dev Biased	3.12E-02	2.27E-02	1.63E-02	2.78E-02	1.42E-02	1.84E-02	1.88E-02
Ps99%/90% (+KTL) Biased	-3.80E-01	-4.27E-01	-4.46E-01	-3.83E-01	-4.29E-01	-4.10E-01	-4.07E-01
Ps99%/90% (-KTL) Biased	-6.71E-01	-6.39E-01	-5.98E-01	-6.42E-01	-5.62E-01	-5.81E-01	-5.83E-01
<b>Un-Biased Statistics</b>							
Average Un-Biased	-5.35E-01	-5.39E-01	-5.31E-01	-5.34E-01	-5.09E-01	-5.17E-01	-5.25E-01
Std Dev Un-Biased	3.49E-02	3.61E-02	4.23E-02	3.83E-02	3.81E-02	4.31E-02	4.02E-02
Ps99%/90% (+KTL) Un-Biased	-3.72E-01	-3.71E-01	-3.34E-01	-3.55E-01	-3.32E-01	-3.15E-01	-3.37E-01
Ps99%/90% (-KTL) Un-Biased	-6.98E-01	-7.08E-01	-7.29E-01	-7.13E-01	-6.87E-01	-7.18E-01	-7.12E-01
<b>Specification MIN</b>	<b>-2.00E-01</b>	<b>-1.30E-01</b>	<b>-1.20E-01</b>	<b>-1.20E-01</b>	<b>-1.10E-01</b>	<b>-1.10E-01</b>	<b>-1.10E-01</b>
Status	PASS	PASS	PASS	PASS	PASS	PASS	PASS

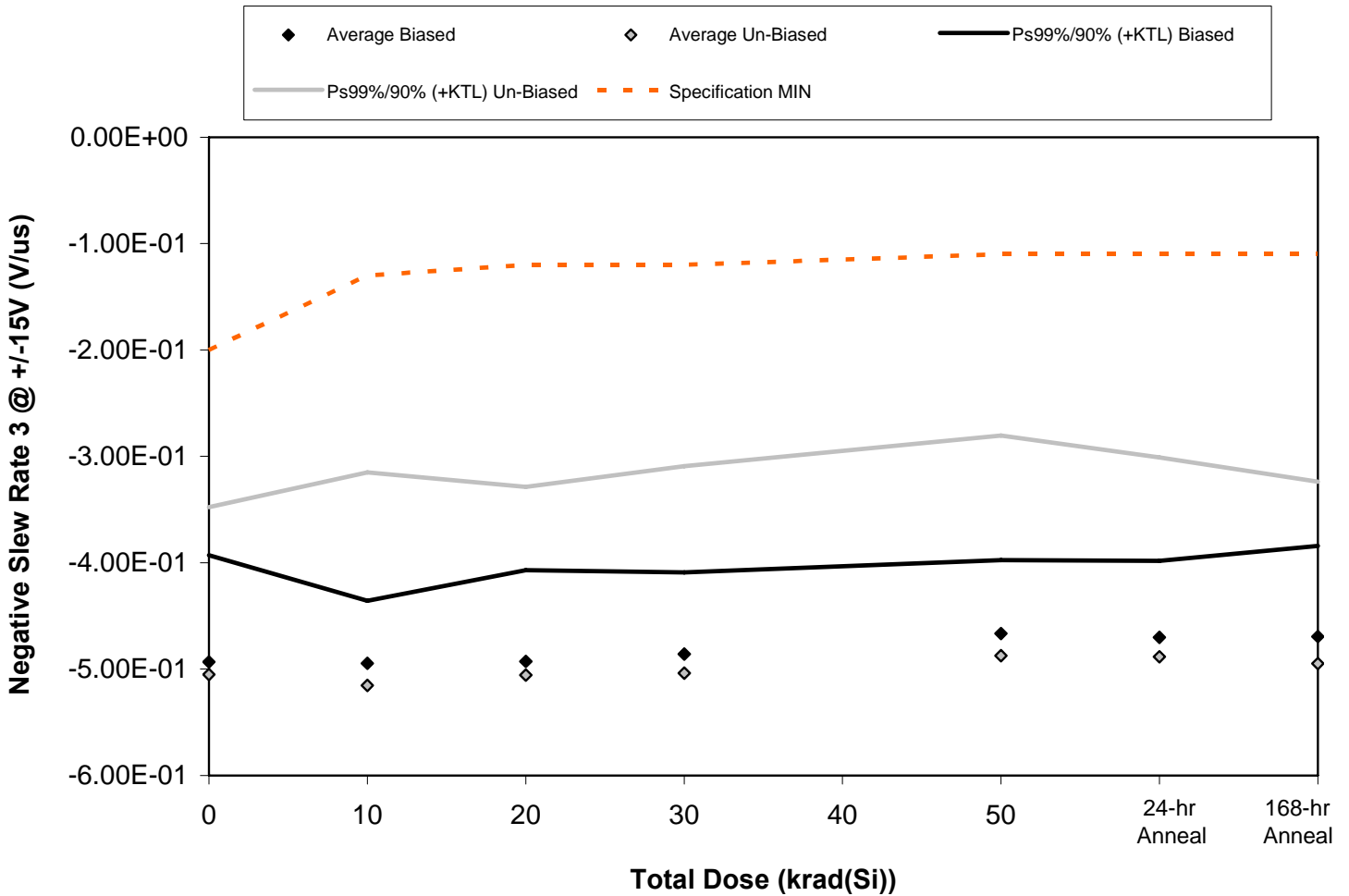

Figure 5.45. Plot of Negative Slew Rate 3 @ +/-15V (V/us) versus total dose. The data show no significant degradation with radiation. The solid diamonds are the average of measured data points from the biased sample (devices irradiated with an electrical bias) while the shaded diamonds are the average from the unbiased sample. The black lines show the effects on the data after application of the biased KTL statistics (solid and dashed lines) while the gray lines show the effects on the data after application of the unbiased KTL statistics (solid and dashed lines). The red dashed lines are the minimum and maximum specification values as defined in the datasheet and/or test plan.





Table 5.45. Raw data for Negative Slew Rate 3 @ +/-15V (V/us) versus total dose, including the statistical analysis, the specification and the status of the testing (pass/fail).

Negative Slew Rate 3 @ +/-15V (V/us)	Total Dose (krad(Si))					24-hr Anneal	168-hr Anneal
	0	10	20	30	50		
Device							
1027	-4.99E-01	-4.99E-01	-4.94E-01	-4.91E-01	-4.80E-01	-4.77E-01	-4.83E-01
1029	-4.91E-01	-5.01E-01	-4.92E-01	-4.94E-01	-4.58E-01	-4.74E-01	-4.71E-01
1030	-5.15E-01	-5.09E-01	-5.19E-01	-5.04E-01	-4.85E-01	-4.87E-01	-4.89E-01
1031	-4.58E-01	-4.78E-01	-4.67E-01	-4.61E-01	-4.52E-01	-4.46E-01	-4.43E-01
1032	-5.03E-01	-4.85E-01	-4.92E-01	-4.79E-01	-4.58E-01	-4.66E-01	-4.61E-01
1033	-4.95E-01	-4.99E-01	-4.94E-01	-4.86E-01	-4.74E-01	-4.74E-01	-4.79E-01
1034	-5.55E-01	-5.70E-01	-5.63E-01	-5.59E-01	-5.48E-01	-5.47E-01	-5.45E-01
1035	-5.22E-01	-5.50E-01	-5.22E-01	-5.36E-01	-5.17E-01	-5.11E-01	-5.21E-01
1036	-4.72E-01	-4.91E-01	-4.79E-01	-4.74E-01	-4.59E-01	-4.61E-01	-4.71E-01
1038	-4.81E-01	-4.67E-01	-4.69E-01	-4.63E-01	-4.39E-01	-4.49E-01	-4.58E-01
1039	-5.48E-01	-5.73E-01	-5.69E-01	-5.96E-01	-5.54E-01	-5.67E-01	-5.89E-01
<b>Biased Statistics</b>							
Average Biased	-4.93E-01	-4.94E-01	-4.93E-01	-4.86E-01	-4.67E-01	-4.70E-01	-4.69E-01
Std Dev Biased	2.15E-02	1.26E-02	1.84E-02	1.65E-02	1.48E-02	1.54E-02	1.83E-02
Ps99%/90% (+KTL) Biased	-3.93E-01	-4.36E-01	-4.07E-01	-4.09E-01	-3.97E-01	-3.98E-01	-3.84E-01
Ps99%/90% (-KTL) Biased	-5.94E-01	-5.53E-01	-5.79E-01	-5.63E-01	-5.36E-01	-5.42E-01	-5.55E-01
<b>Un-Biased Statistics</b>							
Average Un-Biased	-5.05E-01	-5.15E-01	-5.05E-01	-5.04E-01	-4.87E-01	-4.88E-01	-4.95E-01
Std Dev Un-Biased	3.37E-02	4.30E-02	3.79E-02	4.17E-02	4.44E-02	4.02E-02	3.67E-02
Ps99%/90% (+KTL) Un-Biased	-3.48E-01	-3.15E-01	-3.29E-01	-3.09E-01	-2.80E-01	-3.01E-01	-3.24E-01
Ps99%/90% (-KTL) Un-Biased	-6.62E-01	-7.16E-01	-6.82E-01	-6.98E-01	-6.94E-01	-6.76E-01	-6.66E-01
<b>Specification MIN</b>	<b>-2.00E-01</b>	<b>-1.30E-01</b>	<b>-1.20E-01</b>	<b>-1.20E-01</b>	<b>-1.10E-01</b>	<b>-1.10E-01</b>	<b>-1.10E-01</b>
Status	PASS	PASS	PASS	PASS	PASS	PASS	PASS

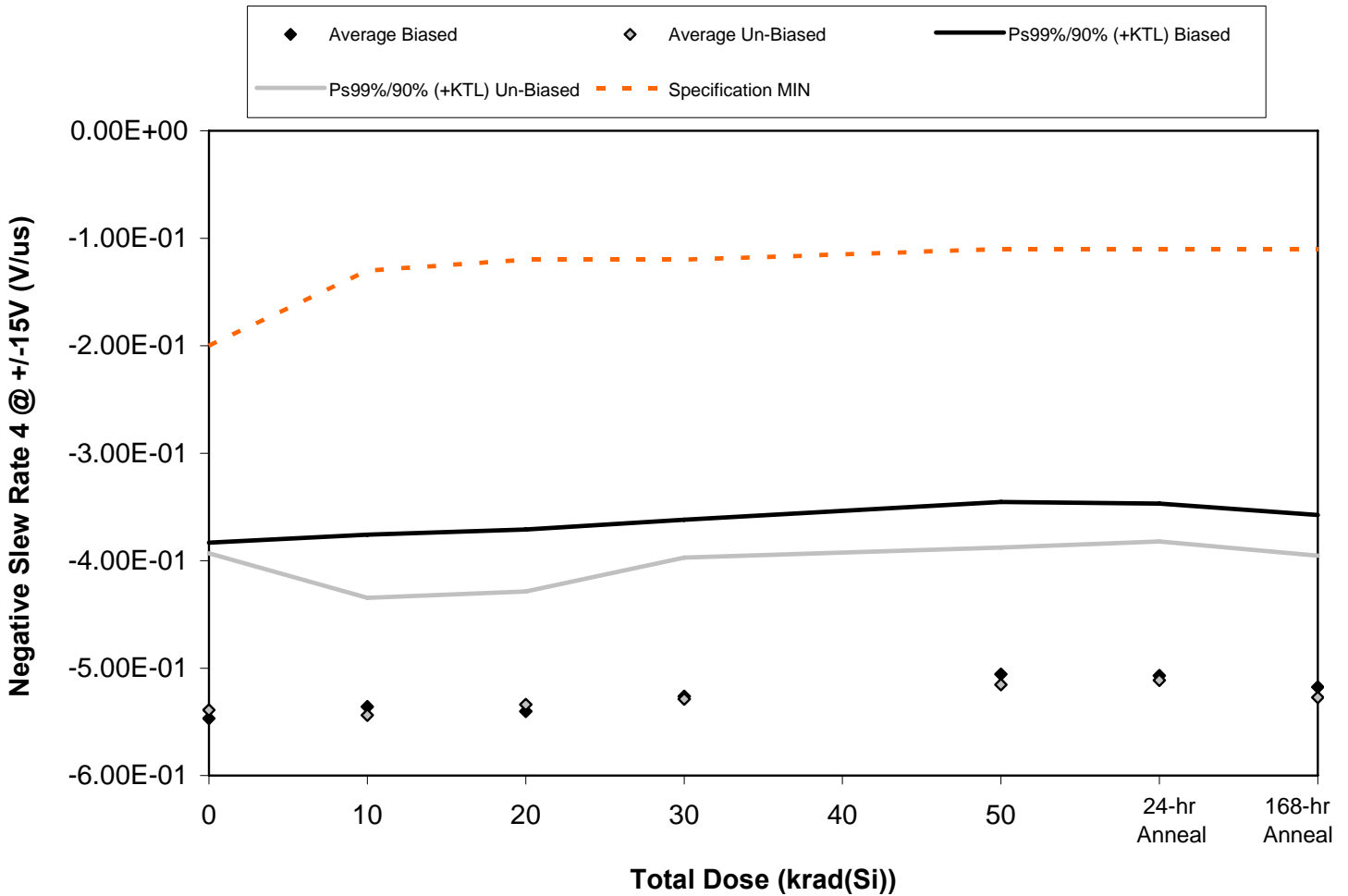

Figure 5.46. Plot of Negative Slew Rate 4 @ +/-15V (V/us) versus total dose. The data show no significant degradation with radiation. The solid diamonds are the average of measured data points from the biased sample (devices irradiated with an electrical bias) while the shaded diamonds are the average from the unbiased sample. The black lines show the effects on the data after application of the biased KTL statistics (solid and dashed lines) while the gray lines show the effects on the data after application of the unbiased KTL statistics (solid and dashed lines). The red dashed lines are the minimum and maximum specification values as defined in the datasheet and/or test plan.



Table 5.46. Raw data for Negative Slew Rate 4 @ +/-15V (V/us) versus total dose, including the statistical analysis, the specification and the status of the testing (pass/fail).

Negative Slew Rate 4 @ +/-15V (V/us)	Total Dose (krad(Si))					24-hr Anneal	168-hr Anneal
	0	10	20	30	50		
Device							
1027	-5.90E-01	-5.77E-01	-5.88E-01	-5.77E-01	-5.63E-01	-5.58E-01	-5.59E-01
1029	-5.30E-01	-5.21E-01	-5.23E-01	-5.14E-01	-4.97E-01	-4.91E-01	-4.95E-01
1030	-5.04E-01	-4.95E-01	-4.99E-01	-4.97E-01	-4.76E-01	-4.76E-01	-4.91E-01
1031	-5.75E-01	-5.66E-01	-5.67E-01	-5.48E-01	-5.08E-01	-5.26E-01	-5.51E-01
1032	-5.35E-01	-5.21E-01	-5.24E-01	-4.96E-01	-4.84E-01	-4.84E-01	-4.92E-01
1033	-4.88E-01	-5.11E-01	-4.94E-01	-4.84E-01	-4.76E-01	-4.73E-01	-4.80E-01
1034	-5.52E-01	-5.61E-01	-5.46E-01	-5.32E-01	-5.23E-01	-5.17E-01	-5.50E-01
1035	-5.31E-01	-5.35E-01	-5.46E-01	-5.23E-01	-5.00E-01	-4.94E-01	-5.23E-01
1036	-5.59E-01	-5.41E-01	-5.45E-01	-5.54E-01	-5.35E-01	-5.37E-01	-5.42E-01
1038	-5.65E-01	-5.71E-01	-5.38E-01	-5.51E-01	-5.43E-01	-5.36E-01	-5.42E-01
1039	-5.55E-01	-5.42E-01	-5.74E-01	-5.50E-01	-5.64E-01	-5.43E-01	-5.59E-01
<b>Biased Statistics</b>							
Average Biased	-5.47E-01	-5.36E-01	-5.40E-01	-5.26E-01	-5.06E-01	-5.07E-01	-5.18E-01
Std Dev Biased	3.51E-02	3.43E-02	3.63E-02	3.52E-02	3.43E-02	3.43E-02	3.43E-02
Ps99%/90% (+KTL) Biased	-3.83E-01	-3.76E-01	-3.71E-01	-3.62E-01	-3.45E-01	-3.47E-01	-3.58E-01
Ps99%/90% (-KTL) Biased	-7.10E-01	-6.96E-01	-7.09E-01	-6.91E-01	-6.66E-01	-6.67E-01	-6.78E-01
<b>Un-Biased Statistics</b>							
Average Un-Biased	-5.39E-01	-5.44E-01	-5.34E-01	-5.29E-01	-5.15E-01	-5.11E-01	-5.27E-01
Std Dev Un-Biased	3.13E-02	2.34E-02	2.25E-02	2.82E-02	2.74E-02	2.77E-02	2.83E-02
Ps99%/90% (+KTL) Un-Biased	-3.93E-01	-4.34E-01	-4.29E-01	-3.97E-01	-3.88E-01	-3.82E-01	-3.95E-01
Ps99%/90% (-KTL) Un-Biased	-6.85E-01	-6.53E-01	-6.39E-01	-6.60E-01	-6.43E-01	-6.41E-01	-6.59E-01
<b>Specification MIN</b>	<b>-2.00E-01</b>	<b>-1.30E-01</b>	<b>-1.20E-01</b>	<b>-1.20E-01</b>	<b>-1.10E-01</b>	<b>-1.10E-01</b>	<b>-1.10E-01</b>
Status	PASS	PASS	PASS	PASS	PASS	PASS	PASS

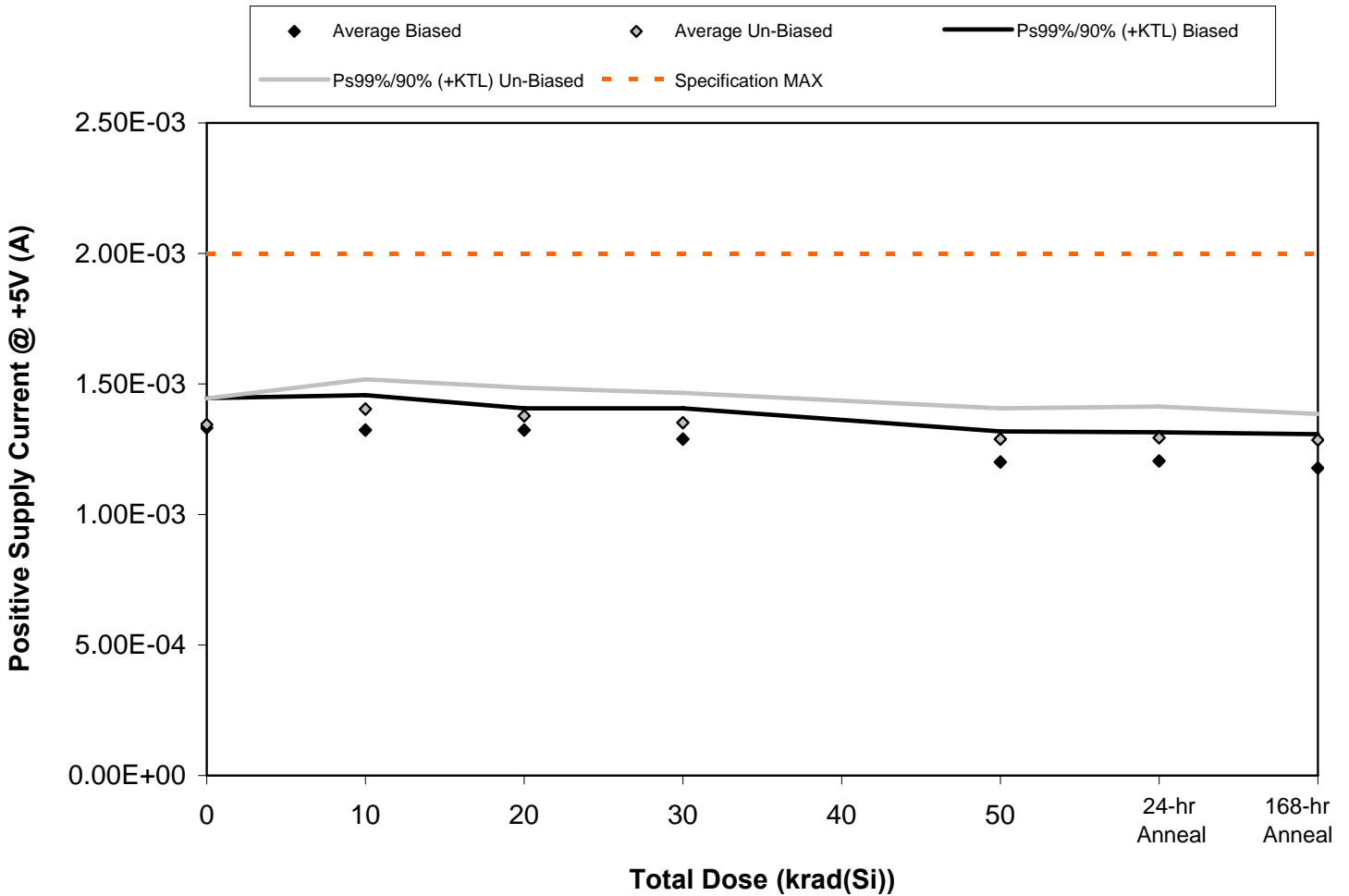

Figure 5.47. Plot of Positive Supply Current @ +5V (A) versus total dose. The data show no significant degradation with radiation. The solid diamonds are the average of measured data points from the biased sample (devices irradiated with an electrical bias) while the shaded diamonds are the average from the unbiased sample. The black lines show the effects on the data after application of the biased KTL statistics (solid and dashed lines) while the gray lines show the effects on the data after application of the unbiased KTL statistics (solid and dashed lines). The red dashed lines are the minimum and maximum specification values as defined in the datasheet and/or test plan.



Table 5.47. Raw data for Positive Supply Current @ +5V (A) versus total dose, including the statistical analysis, the specification and the status of the testing (pass/fail).

Positive Supply Current @ +5V (A)	Total Dose (krad(Si))					24-hr Anneal	168-hr Anneal
	0	10	20	30	50		
Device							
1027	1.37E-03	1.37E-03	1.35E-03	1.32E-03	1.24E-03	1.24E-03	1.22E-03
1029	1.31E-03	1.29E-03	1.30E-03	1.27E-03	1.18E-03	1.19E-03	1.16E-03
1030	1.32E-03	1.31E-03	1.31E-03	1.26E-03	1.17E-03	1.18E-03	1.15E-03
1031	1.32E-03	1.33E-03	1.33E-03	1.30E-03	1.21E-03	1.21E-03	1.18E-03
1032	1.33E-03	1.33E-03	1.33E-03	1.30E-03	1.21E-03	1.22E-03	1.18E-03
1033	1.32E-03	1.38E-03	1.36E-03	1.33E-03	1.27E-03	1.27E-03	1.27E-03
1034	1.38E-03	1.44E-03	1.42E-03	1.39E-03	1.33E-03	1.34E-03	1.32E-03
1035	1.34E-03	1.40E-03	1.38E-03	1.36E-03	1.29E-03	1.29E-03	1.28E-03
1036	1.35E-03	1.41E-03	1.38E-03	1.35E-03	1.29E-03	1.29E-03	1.29E-03
1038	1.33E-03	1.39E-03	1.36E-03	1.33E-03	1.27E-03	1.28E-03	1.27E-03
1039	1.37E-03	1.38E-03	1.38E-03	1.37E-03	1.37E-03	1.37E-03	1.37E-03
<b>Biased Statistics</b>							
Average Biased	1.33E-03	1.32E-03	1.32E-03	1.29E-03	1.20E-03	1.21E-03	1.18E-03
Std Dev Biased	2.44E-05	2.85E-05	1.79E-05	2.54E-05	2.51E-05	2.36E-05	2.77E-05
Ps99%/90% (+KTL) Biased	1.45E-03	1.46E-03	1.41E-03	1.41E-03	1.32E-03	1.32E-03	1.31E-03
Ps99%/90% (-KTL) Biased	1.22E-03	1.19E-03	1.24E-03	1.17E-03	1.08E-03	1.10E-03	1.05E-03
<b>Un-Biased Statistics</b>							
Average Un-Biased	1.34E-03	1.40E-03	1.38E-03	1.35E-03	1.29E-03	1.29E-03	1.29E-03
Std Dev Un-Biased	2.14E-05	2.43E-05	2.31E-05	2.45E-05	2.53E-05	2.56E-05	2.12E-05
Ps99%/90% (+KTL) Un-Biased	1.44E-03	1.52E-03	1.49E-03	1.47E-03	1.41E-03	1.41E-03	1.38E-03
Ps99%/90% (-KTL) Un-Biased	1.24E-03	1.29E-03	1.27E-03	1.24E-03	1.17E-03	1.17E-03	1.19E-03
<b>Specification MAX</b>	<b>2.00E-03</b>	<b>2.00E-03</b>	<b>2.00E-03</b>	<b>2.00E-03</b>	<b>2.00E-03</b>	<b>2.00E-03</b>	<b>2.00E-03</b>
Status	PASS	PASS	PASS	PASS	PASS	PASS	PASS

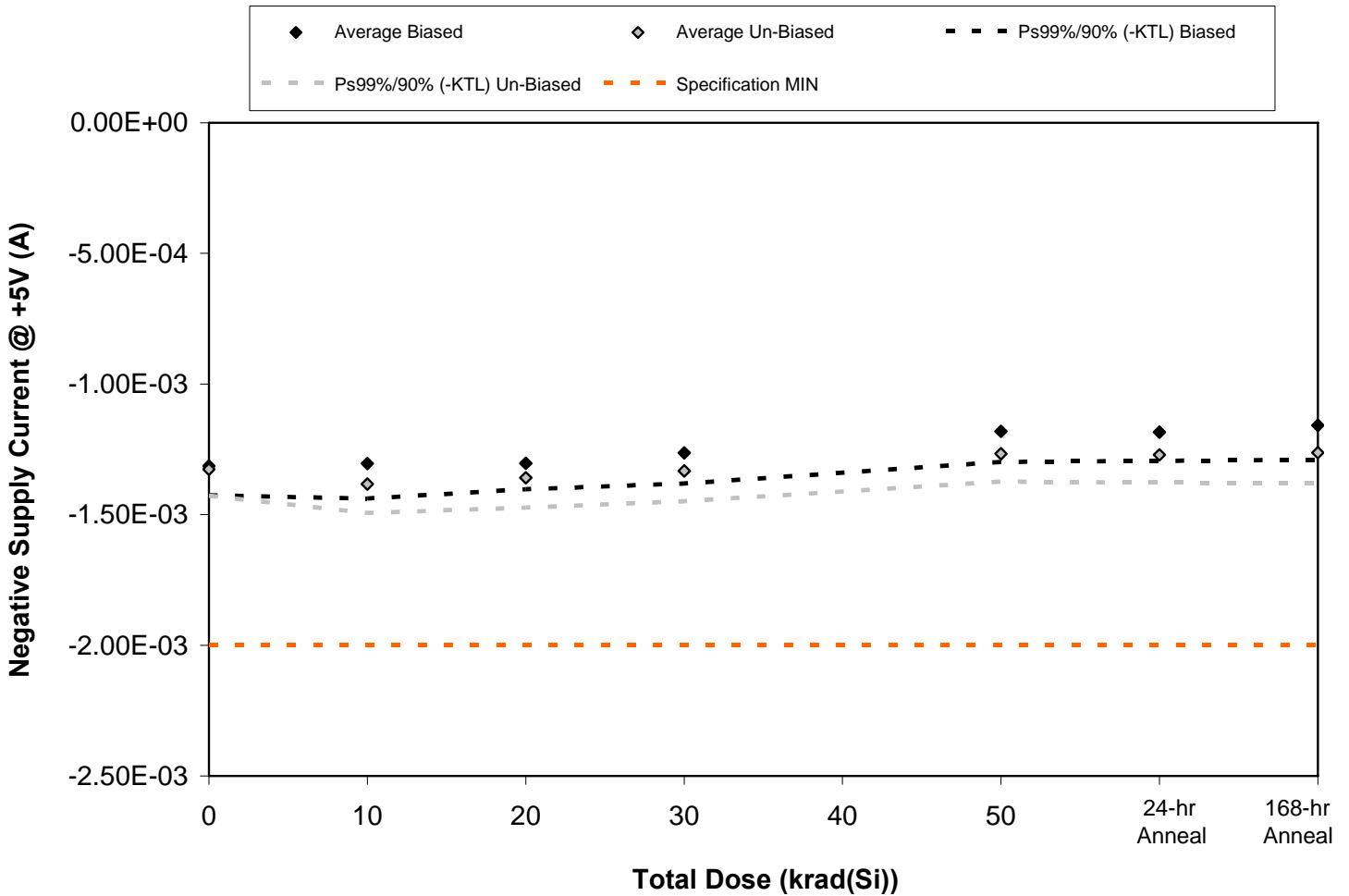

Figure 5.48. Plot of Negative Supply Current @ +5V (A) versus total dose. The data show no significant degradation with radiation. The solid diamonds are the average of measured data points from the biased sample (devices irradiated with an electrical bias) while the shaded diamonds are the average from the unbiased sample. The black lines show the effects on the data after application of the biased KTL statistics (solid and dashed lines) while the gray lines show the effects on the data after application of the unbiased KTL statistics (solid and dashed lines). The red dashed lines are the minimum and maximum specification values as defined in the datasheet and/or test plan.



Table 5.48. Raw data for Negative Supply Current @ +5V (A) versus total dose, including the statistical analysis, the specification and the status of the testing (pass/fail).

Negative Supply Current @ +5V (A)	Total Dose (krad(Si))					24-hr Anneal	168-hr Anneal
	0	10	20	30	50		
Device							
1027	-1.35E-03	-1.35E-03	-1.33E-03	-1.30E-03	-1.21E-03	-1.21E-03	-1.20E-03
1029	-1.29E-03	-1.28E-03	-1.27E-03	-1.25E-03	-1.16E-03	-1.16E-03	-1.14E-03
1030	-1.30E-03	-1.28E-03	-1.29E-03	-1.23E-03	-1.15E-03	-1.16E-03	-1.13E-03
1031	-1.31E-03	-1.31E-03	-1.31E-03	-1.27E-03	-1.19E-03	-1.19E-03	-1.16E-03
1032	-1.32E-03	-1.30E-03	-1.31E-03	-1.27E-03	-1.19E-03	-1.20E-03	-1.16E-03
1033	-1.30E-03	-1.36E-03	-1.34E-03	-1.31E-03	-1.25E-03	-1.25E-03	-1.24E-03
1034	-1.36E-03	-1.42E-03	-1.40E-03	-1.37E-03	-1.30E-03	-1.31E-03	-1.30E-03
1035	-1.32E-03	-1.38E-03	-1.36E-03	-1.33E-03	-1.27E-03	-1.27E-03	-1.26E-03
1036	-1.33E-03	-1.38E-03	-1.36E-03	-1.34E-03	-1.27E-03	-1.28E-03	-1.27E-03
1038	-1.32E-03	-1.37E-03	-1.34E-03	-1.32E-03	-1.25E-03	-1.25E-03	-1.25E-03
1039	-1.35E-03	-1.36E-03	-1.36E-03	-1.35E-03	-1.34E-03	-1.35E-03	-1.35E-03
<b>Biased Statistics</b>							
Average Biased	-1.31E-03	-1.30E-03	-1.30E-03	-1.26E-03	-1.18E-03	-1.18E-03	-1.16E-03
Std Dev Biased	2.41E-05	2.87E-05	2.13E-05	2.52E-05	2.52E-05	2.36E-05	2.81E-05
Ps99%/90% (+KTL) Biased	-1.20E-03	-1.17E-03	-1.20E-03	-1.15E-03	-1.06E-03	-1.07E-03	-1.03E-03
Ps99%/90% (-KTL) Biased	-1.43E-03	-1.44E-03	-1.40E-03	-1.38E-03	-1.30E-03	-1.29E-03	-1.29E-03
<b>Un-Biased Statistics</b>							
Average Un-Biased	-1.33E-03	-1.38E-03	-1.36E-03	-1.33E-03	-1.27E-03	-1.27E-03	-1.26E-03
Std Dev Un-Biased	2.17E-05	2.38E-05	2.44E-05	2.48E-05	2.29E-05	2.30E-05	2.49E-05
Ps99%/90% (+KTL) Un-Biased	-1.23E-03	-1.27E-03	-1.24E-03	-1.22E-03	-1.16E-03	-1.16E-03	-1.15E-03
Ps99%/90% (-KTL) Un-Biased	-1.43E-03	-1.49E-03	-1.47E-03	-1.45E-03	-1.37E-03	-1.38E-03	-1.38E-03
<b>Specification MIN</b>	<b>-2.00E-03</b>	<b>-2.00E-03</b>	<b>-2.00E-03</b>	<b>-2.00E-03</b>	<b>-2.00E-03</b>	<b>-2.00E-03</b>	<b>-2.00E-03</b>
Status	PASS	PASS	PASS	PASS	PASS	PASS	PASS

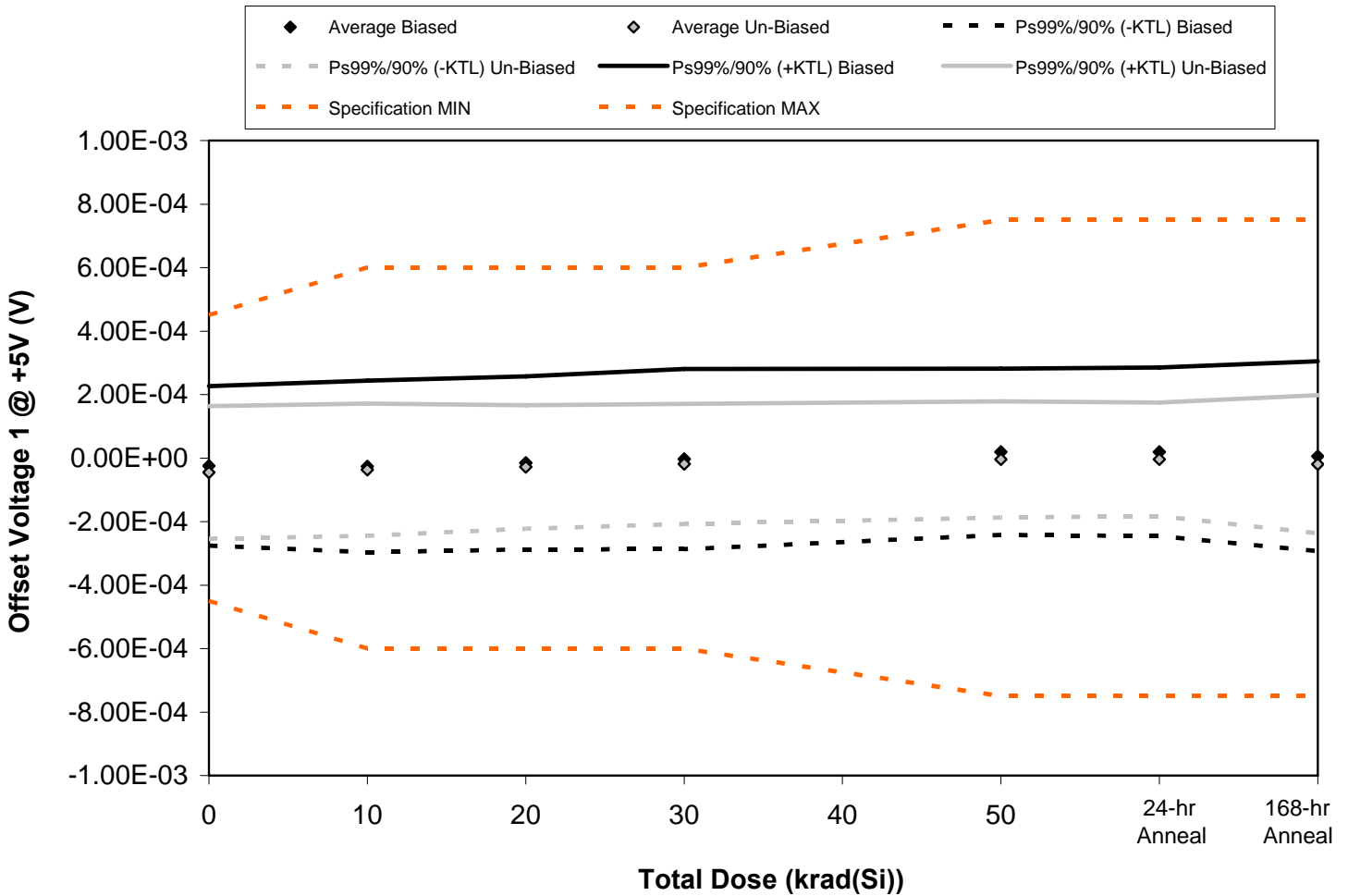

Figure 5.49. Plot of Offset Voltage 1 @ +5V (V) versus total dose. The data show no significant degradation with radiation. The solid diamonds are the average of measured data points from the biased sample (devices irradiated with an electrical bias) while the shaded diamonds are the average from the unbiased sample. The black lines show the effects on the data after application of the biased KTL statistics (solid and dashed lines) while the gray lines show the effects on the data after application of the unbiased KTL statistics (solid and dashed lines). The red dashed lines are the minimum and maximum specification values as defined in the datasheet and/or test plan.





Table 5.49. Raw data for Offset Voltage 1 @ +5V (V) versus total dose, including the statistical analysis, the specification and the status of the testing (pass/fail).

Offset Voltage 1 @ +5V (V)	Total Dose (krad(Si))					24-hr Anneal	168-hr Anneal
	0	10	20	30	50		
Device							
1027	-4.28E-05	-4.93E-05	-4.32E-05	-3.22E-05	-1.23E-05	-1.28E-05	-2.39E-05
1029	-2.98E-05	-2.59E-05	-1.18E-05	-4.23E-06	1.15E-05	9.53E-06	-1.82E-06
1030	5.64E-05	6.15E-05	7.25E-05	8.92E-05	1.02E-04	1.04E-04	1.01E-04
1031	-9.20E-05	-9.77E-05	-8.63E-05	-7.59E-05	-4.54E-05	-4.50E-05	-7.18E-05
1032	-1.40E-05	-1.79E-05	-4.84E-06	8.57E-06	4.18E-05	4.16E-05	2.63E-05
1033	-4.43E-05	-3.88E-05	-2.58E-05	-1.49E-05	7.19E-07	7.19E-07	-1.44E-05
1034	3.10E-05	4.02E-05	4.31E-05	5.01E-05	6.16E-05	6.07E-05	5.93E-05
1035	-5.80E-05	-5.06E-05	-4.13E-05	-3.39E-05	-1.82E-05	-1.90E-05	-3.51E-05
1036	-7.83E-05	-6.93E-05	-5.88E-05	-4.91E-05	-3.34E-05	-3.20E-05	-5.36E-05
1038	-7.61E-05	-6.45E-05	-5.58E-05	-4.46E-05	-3.15E-05	-2.98E-05	-5.20E-05
1039	-4.25E-05	-4.44E-05	-4.66E-05	-4.44E-05	-4.30E-05	-4.32E-05	-4.50E-05
<b>Biased Statistics</b>							
Average Biased	-2.44E-05	-2.58E-05	-1.47E-05	-2.92E-06	1.95E-05	1.95E-05	5.93E-06
Std Dev Biased	5.38E-05	5.79E-05	5.84E-05	6.09E-05	5.61E-05	5.69E-05	6.41E-05
Ps99%/90% (+KTL) Biased	2.27E-04	2.44E-04	2.58E-04	2.81E-04	2.81E-04	2.85E-04	3.05E-04
Ps99%/90% (-KTL) Biased	-2.75E-04	-2.96E-04	-2.87E-04	-2.87E-04	-2.42E-04	-2.46E-04	-2.93E-04
<b>Un-Biased Statistics</b>							
Average Un-Biased	-4.51E-05	-3.66E-05	-2.77E-05	-1.85E-05	-4.18E-06	-3.87E-06	-1.92E-05
Std Dev Un-Biased	4.48E-05	4.46E-05	4.17E-05	4.05E-05	3.92E-05	3.84E-05	4.66E-05
Ps99%/90% (+KTL) Un-Biased	1.64E-04	1.71E-04	1.67E-04	1.71E-04	1.79E-04	1.75E-04	1.98E-04
Ps99%/90% (-KTL) Un-Biased	-2.54E-04	-2.45E-04	-2.22E-04	-2.08E-04	-1.87E-04	-1.83E-04	-2.37E-04
<b>Specification MIN</b>	<b>-4.50E-04</b>	<b>-6.00E-04</b>	<b>-6.00E-04</b>	<b>-6.00E-04</b>	<b>-7.50E-04</b>	<b>-7.50E-04</b>	<b>-7.50E-04</b>
Status	PASS	PASS	PASS	PASS	PASS	PASS	PASS
<b>Specification MAX</b>	<b>4.50E-04</b>	<b>6.00E-04</b>	<b>6.00E-04</b>	<b>6.00E-04</b>	<b>7.50E-04</b>	<b>7.50E-04</b>	<b>7.50E-04</b>
Status	PASS	PASS	PASS	PASS	PASS	PASS	PASS

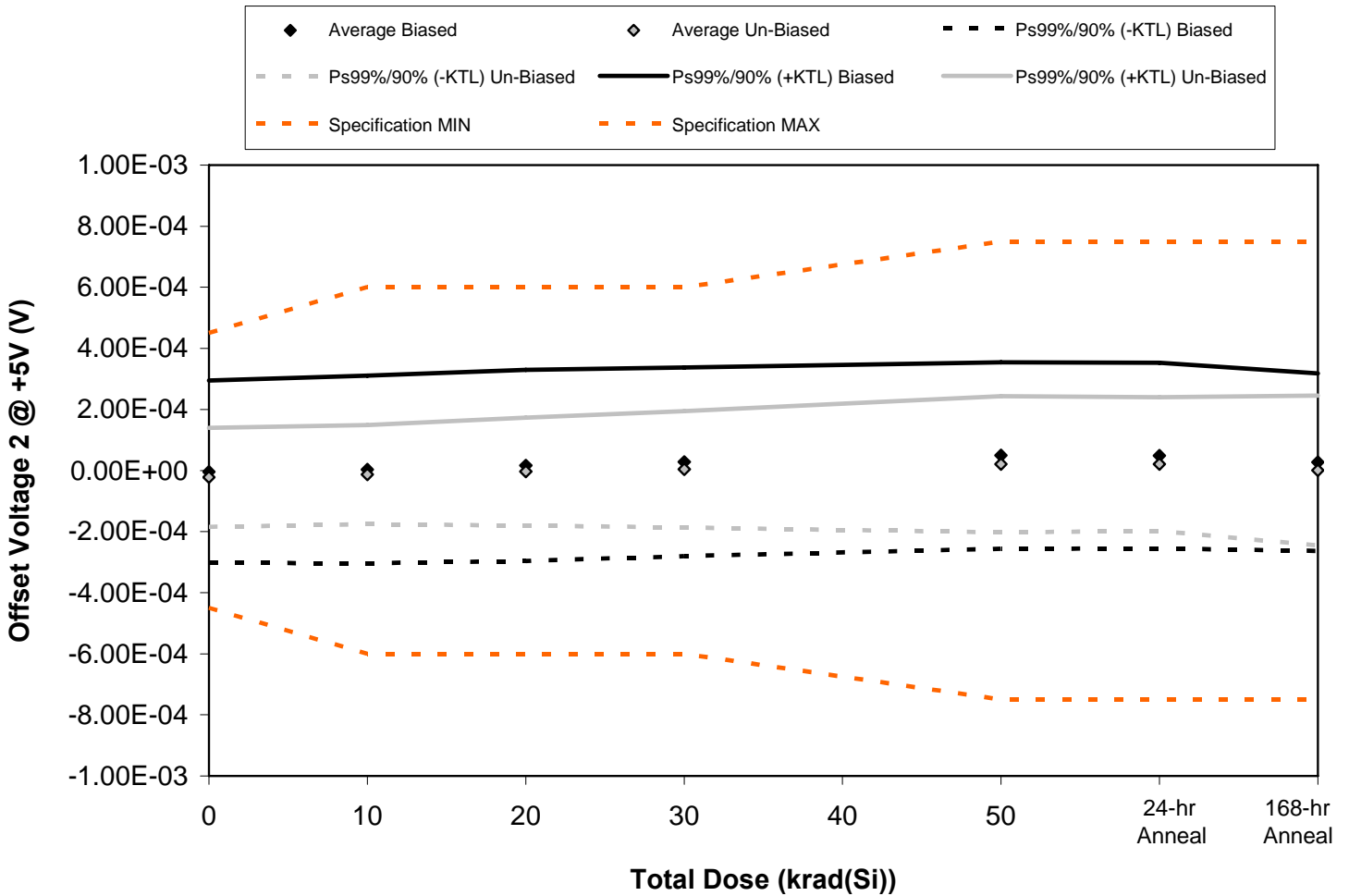

Figure 5.50. Plot of Offset Voltage 2 @ +5V (V) versus total dose. The data show no significant degradation with radiation. The solid diamonds are the average of measured data points from the biased sample (devices irradiated with an electrical bias) while the shaded diamonds are the average from the unbiased sample. The black lines show the effects on the data after application of the biased KTL statistics (solid and dashed lines) while the gray lines show the effects on the data after application of the unbiased KTL statistics (solid and dashed lines). The red dashed lines are the minimum and maximum specification values as defined in the datasheet and/or test plan.



Table 5.50. Raw data for Offset Voltage 2 @ +5V (V) versus total dose, including the statistical analysis, the specification and the status of the testing (pass/fail).

Offset Voltage 2 @ +5V (V)	Total Dose (krad(Si))					24-hr Anneal	168-hr Anneal
	0	10	20	30	50		
Device							
1027	-5.53E-05	-5.13E-05	-3.89E-05	-2.73E-05	-3.51E-06	-3.99E-06	-1.74E-05
1029	4.47E-05	5.77E-05	7.20E-05	8.28E-05	1.03E-04	1.03E-04	6.59E-05
1030	5.46E-05	6.39E-05	7.57E-05	8.87E-05	1.08E-04	1.07E-04	9.10E-05
1031	-8.86E-05	-8.10E-05	-7.10E-05	-5.63E-05	-3.65E-05	-3.63E-05	-5.72E-05
1032	2.48E-05	2.84E-05	4.27E-05	5.48E-05	7.49E-05	7.39E-05	5.59E-05
1033	-4.85E-05	-4.66E-05	-3.72E-05	-2.74E-05	-1.28E-05	-1.21E-05	-4.03E-05
1034	3.14E-05	3.65E-05	5.08E-05	6.40E-05	8.92E-05	8.84E-05	8.60E-05
1035	-4.46E-05	-3.64E-05	-3.39E-05	-3.47E-05	-3.17E-05	-3.02E-05	-4.02E-05
1036	-5.56E-06	8.57E-06	2.01E-05	2.56E-05	4.37E-05	4.41E-05	1.27E-05
1038	-4.43E-05	-2.85E-05	-1.59E-05	-6.64E-06	1.52E-05	1.54E-05	-1.63E-05
1039	2.38E-07	-4.88E-07	-1.58E-06	-1.33E-06	-1.45E-06	-6.09E-07	7.16E-07
<b>Biased Statistics</b>							
Average Biased	-3.99E-06	3.52E-06	1.61E-05	2.86E-05	4.92E-05	4.86E-05	2.76E-05
Std Dev Biased	6.41E-05	6.59E-05	6.71E-05	6.63E-05	6.55E-05	6.51E-05	6.23E-05
Ps99%/90% (+KTL) Biased	2.95E-04	3.11E-04	3.29E-04	3.38E-04	3.55E-04	3.52E-04	3.18E-04
Ps99%/90% (-KTL) Biased	-3.03E-04	-3.04E-04	-2.97E-04	-2.81E-04	-2.56E-04	-2.55E-04	-2.63E-04
<b>Un-Biased Statistics</b>							
Average Un-Biased	-2.23E-05	-1.33E-05	-3.22E-06	4.18E-06	2.07E-05	2.11E-05	3.78E-07
Std Dev Un-Biased	3.48E-05	3.47E-05	3.78E-05	4.08E-05	4.78E-05	4.69E-05	5.26E-05
Ps99%/90% (+KTL) Un-Biased	1.40E-04	1.49E-04	1.73E-04	1.95E-04	2.44E-04	2.40E-04	2.46E-04
Ps99%/90% (-KTL) Un-Biased	-1.85E-04	-1.75E-04	-1.80E-04	-1.86E-04	-2.02E-04	-1.98E-04	-2.45E-04
<b>Specification MIN</b>	<b>-4.50E-04</b>	<b>-6.00E-04</b>	<b>-6.00E-04</b>	<b>-6.00E-04</b>	<b>-7.50E-04</b>	<b>-7.50E-04</b>	<b>-7.50E-04</b>
Status	PASS	PASS	PASS	PASS	PASS	PASS	PASS
<b>Specification MAX</b>	<b>4.50E-04</b>	<b>6.00E-04</b>	<b>6.00E-04</b>	<b>6.00E-04</b>	<b>7.50E-04</b>	<b>7.50E-04</b>	<b>7.50E-04</b>
Status	PASS	PASS	PASS	PASS	PASS	PASS	PASS

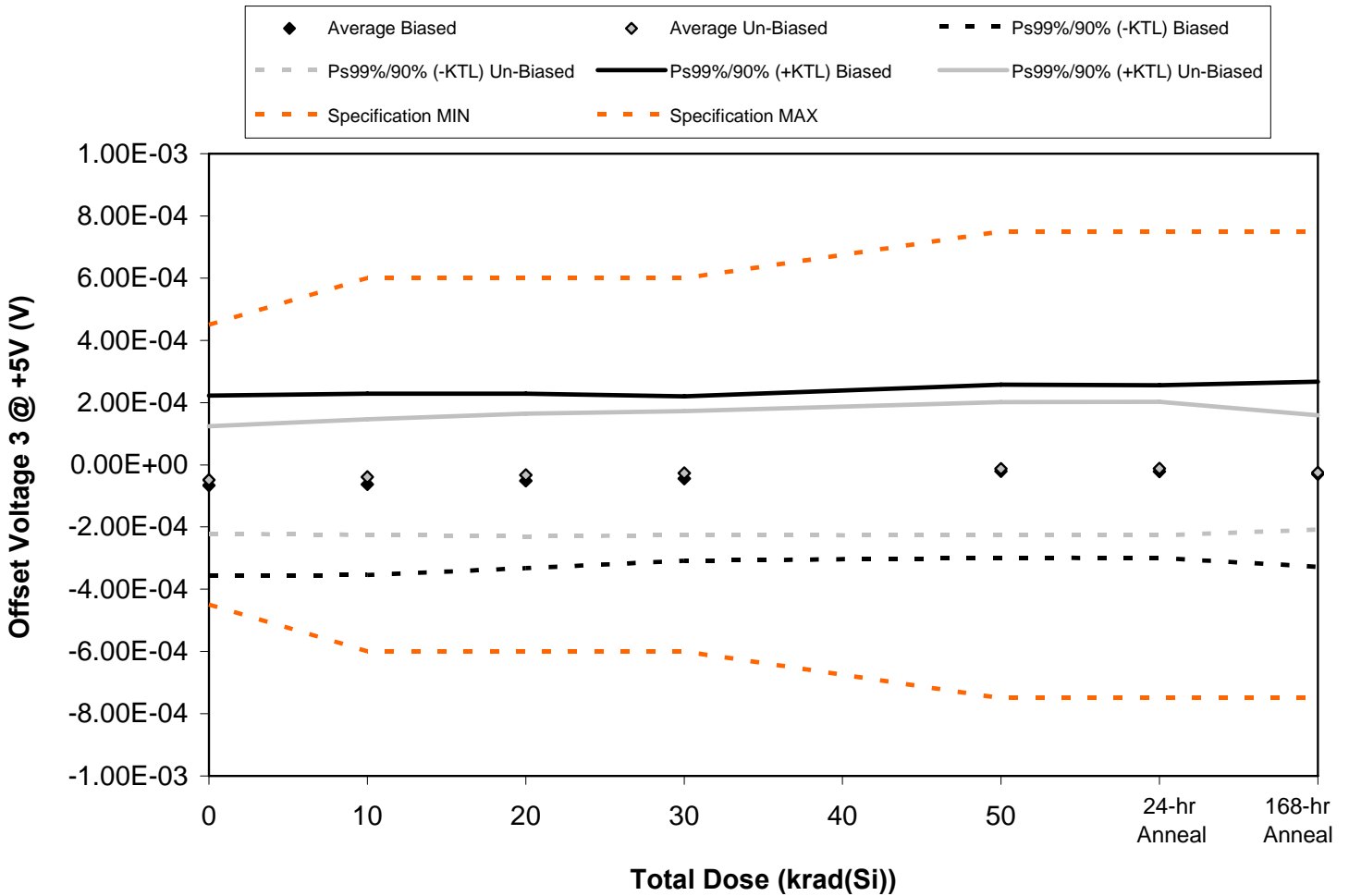

Figure 5.51. Plot of Offset Voltage 3 @ +5V (V) versus total dose. The data show no significant degradation with radiation. The solid diamonds are the average of measured data points from the biased sample (devices irradiated with an electrical bias) while the shaded diamonds are the average from the unbiased sample. The black lines show the effects on the data after application of the biased KTL statistics (solid and dashed lines) while the gray lines show the effects on the data after application of the unbiased KTL statistics (solid and dashed lines). The red dashed lines are the minimum and maximum specification values as defined in the datasheet and/or test plan.



Table 5.51. Raw data for Offset Voltage 3 @ +5V (V) versus total dose, including the statistical analysis, the specification and the status of the testing (pass/fail).

Offset Voltage 3 @ +5V (V)	Total Dose (krad(Si))					24-hr Anneal	168-hr Anneal
	0	10	20	30	50		
Device							
1027	-8.21E-05	-7.62E-05	-6.83E-05	-6.01E-05	-4.22E-05	-4.30E-05	-5.54E-05
1029	-1.18E-04	-1.12E-04	-9.56E-05	-8.31E-05	-6.43E-05	-6.83E-05	-7.91E-05
1030	1.39E-05	1.75E-05	2.50E-05	2.35E-05	5.49E-05	5.27E-05	4.67E-05
1031	-1.28E-04	-1.28E-04	-1.16E-04	-1.07E-04	-8.06E-05	-7.97E-05	-9.28E-05
1032	-1.92E-05	-1.51E-05	-3.99E-06	6.28E-06	2.97E-05	2.96E-05	2.81E-05
1033	-5.69E-05	-5.53E-05	-4.96E-05	-4.43E-05	-3.17E-05	-3.02E-05	-4.39E-05
1034	-8.98E-05	-8.19E-05	-8.24E-05	-7.70E-05	-6.96E-05	-6.99E-05	-7.44E-05
1035	-1.72E-05	-6.29E-06	3.85E-06	5.91E-06	1.87E-05	1.62E-05	9.17E-06
1036	-7.54E-05	-6.47E-05	-5.43E-05	-4.61E-05	-2.91E-05	-2.56E-05	-3.51E-05
1038	-3.51E-06	1.09E-05	1.81E-05	2.79E-05	4.71E-05	4.96E-05	2.14E-05
1039	-8.18E-05	-8.20E-05	-8.37E-05	-8.04E-05	-7.97E-05	-8.11E-05	-7.98E-05
<b>Biased Statistics</b>							
Average Biased	-6.67E-05	-6.27E-05	-5.17E-05	-4.40E-05	-2.05E-05	-2.17E-05	-3.05E-05
Std Dev Biased	6.20E-05	6.24E-05	6.01E-05	5.66E-05	5.96E-05	5.95E-05	6.38E-05
Ps99%/90% (+KTL) Biased	2.23E-04	2.28E-04	2.29E-04	2.20E-04	2.58E-04	2.56E-04	2.67E-04
Ps99%/90% (-KTL) Biased	-3.56E-04	-3.54E-04	-3.32E-04	-3.08E-04	-2.99E-04	-2.99E-04	-3.28E-04
<b>Un-Biased Statistics</b>							
Average Un-Biased	-4.85E-05	-3.95E-05	-3.29E-05	-2.67E-05	-1.29E-05	-1.20E-05	-2.46E-05
Std Dev Un-Biased	3.71E-05	3.98E-05	4.23E-05	4.26E-05	4.59E-05	4.60E-05	3.94E-05
Ps99%/90% (+KTL) Un-Biased	1.25E-04	1.46E-04	1.64E-04	1.72E-04	2.01E-04	2.03E-04	1.59E-04
Ps99%/90% (-KTL) Un-Biased	-2.22E-04	-2.25E-04	-2.30E-04	-2.26E-04	-2.27E-04	-2.27E-04	-2.08E-04
<b>Specification MIN</b>	<b>-4.50E-04</b>	<b>-6.00E-04</b>	<b>-6.00E-04</b>	<b>-6.00E-04</b>	<b>-7.50E-04</b>	<b>-7.50E-04</b>	<b>-7.50E-04</b>
Status	PASS	PASS	PASS	PASS	PASS	PASS	PASS
<b>Specification MAX</b>	<b>4.50E-04</b>	<b>6.00E-04</b>	<b>6.00E-04</b>	<b>6.00E-04</b>	<b>7.50E-04</b>	<b>7.50E-04</b>	<b>7.50E-04</b>
Status	PASS	PASS	PASS	PASS	PASS	PASS	PASS

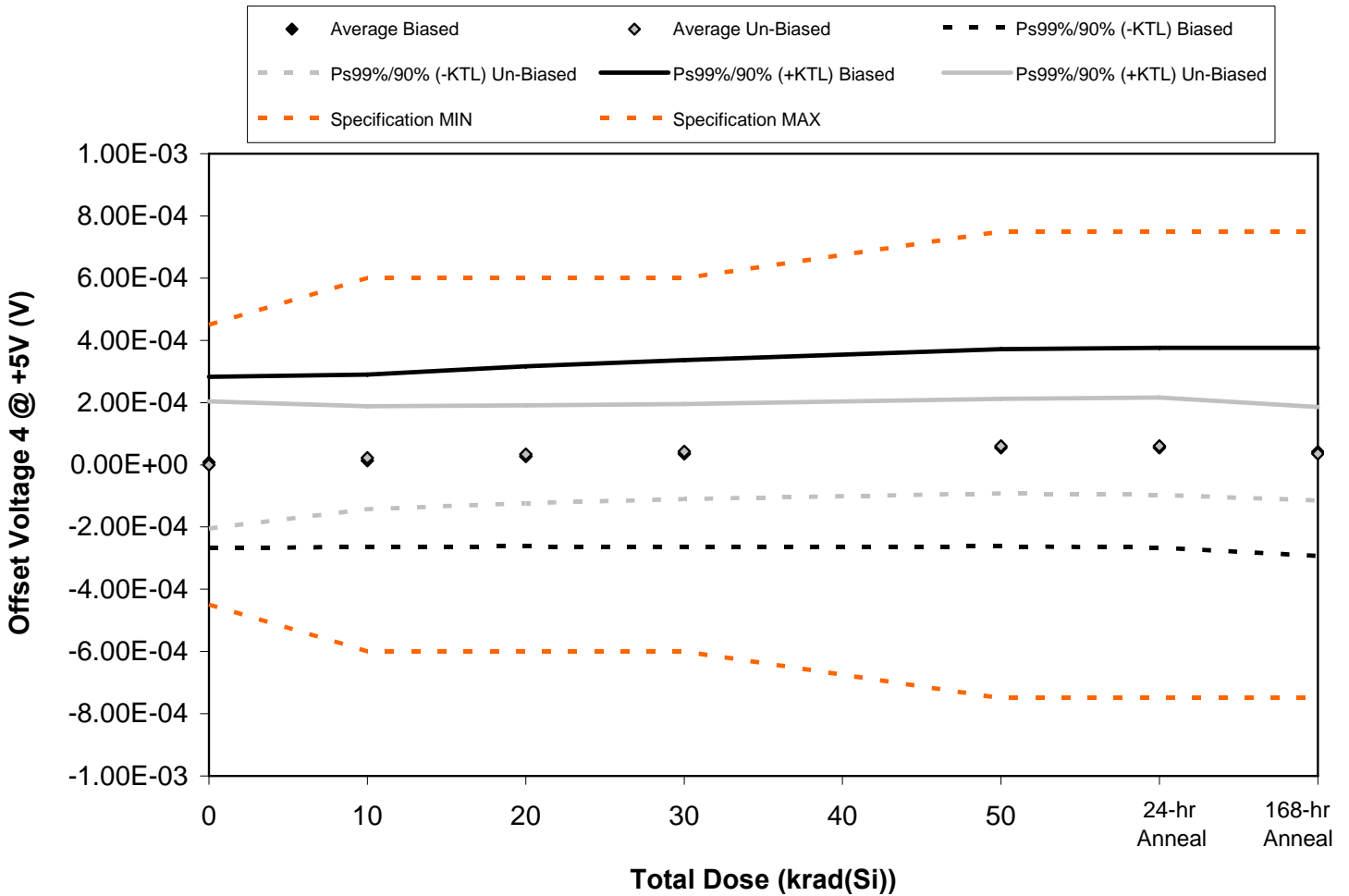

Figure 5.52. Plot of Offset Voltage 4 @ +5V (V) versus total dose. The data show no significant degradation with radiation. The solid diamonds are the average of measured data points from the biased sample (devices irradiated with an electrical bias) while the shaded diamonds are the average from the unbiased sample. The black lines show the effects on the data after application of the biased KTL statistics (solid and dashed lines) while the gray lines show the effects on the data after application of the unbiased KTL statistics (solid and dashed lines). The red dashed lines are the minimum and maximum specification values as defined in the datasheet and/or test plan.



Table 5.52. Raw data for Offset Voltage 4 @ +5V (V) versus total dose, including the statistical analysis, the specification and the status of the testing (pass/fail).

Offset Voltage 4 @ +5V (V)	Total Dose (krad(Si))					24-hr Anneal	168-hr Anneal
	0	10	20	30	50		
Device							
1027	-3.67E-05	-3.49E-05	-2.28E-05	-1.58E-05	-8.33E-06	-8.70E-06	-2.76E-05
1029	7.56E-05	9.15E-05	1.07E-04	1.16E-04	1.42E-04	1.42E-04	1.35E-04
1030	-6.36E-05	-5.28E-05	-4.23E-05	-3.94E-05	-1.49E-05	-1.71E-05	-3.24E-05
1031	7.85E-06	1.39E-05	2.56E-05	3.71E-05	5.60E-05	5.53E-05	5.25E-05
1032	5.53E-05	4.85E-05	6.81E-05	8.03E-05	1.00E-04	1.01E-04	7.98E-05
1033	-1.61E-05	-3.63E-06	5.91E-06	1.58E-05	3.62E-05	3.57E-05	-2.50E-07
1034	3.14E-05	3.83E-05	4.66E-05	5.23E-05	6.54E-05	6.52E-05	4.90E-05
1035	4.38E-05	5.58E-05	6.22E-05	6.95E-05	8.75E-05	9.02E-05	5.66E-05
1036	5.31E-06	4.87E-05	6.38E-05	7.38E-05	9.41E-05	9.19E-05	6.93E-05
1038	-6.69E-05	-2.54E-05	-9.42E-06	3.60E-07	1.85E-05	1.58E-05	2.77E-06
1039	-5.36E-05	-5.81E-05	-5.58E-05	-5.67E-05	-5.50E-05	-5.41E-05	-5.65E-05
<b>Biased Statistics</b>							
Average Biased	7.68E-06	1.33E-05	2.71E-05	3.55E-05	5.49E-05	5.45E-05	4.14E-05
Std Dev Biased	5.90E-05	5.93E-05	6.20E-05	6.45E-05	6.79E-05	6.88E-05	7.17E-05
Ps99%/90% (+KTL) Biased	2.83E-04	2.90E-04	3.17E-04	3.37E-04	3.72E-04	3.76E-04	3.76E-04
Ps99%/90% (-KTL) Biased	-2.68E-04	-2.63E-04	-2.62E-04	-2.66E-04	-2.62E-04	-2.67E-04	-2.93E-04
<b>Un-Biased Statistics</b>							
Average Un-Biased	-4.87E-07	2.27E-05	3.38E-05	4.23E-05	6.03E-05	5.97E-05	3.55E-05
Std Dev Un-Biased	4.38E-05	3.54E-05	3.36E-05	3.28E-05	3.26E-05	3.35E-05	3.21E-05
Ps99%/90% (+KTL) Un-Biased	2.04E-04	1.88E-04	1.91E-04	1.95E-04	2.12E-04	2.16E-04	1.85E-04
Ps99%/90% (-KTL) Un-Biased	-2.05E-04	-1.42E-04	-1.23E-04	-1.10E-04	-9.16E-05	-9.66E-05	-1.14E-04
<b>Specification MIN</b>	<b>-4.50E-04</b>	<b>-6.00E-04</b>	<b>-6.00E-04</b>	<b>-6.00E-04</b>	<b>-7.50E-04</b>	<b>-7.50E-04</b>	<b>-7.50E-04</b>
Status	PASS	PASS	PASS	PASS	PASS	PASS	PASS
<b>Specification MAX</b>	<b>4.50E-04</b>	<b>6.00E-04</b>	<b>6.00E-04</b>	<b>6.00E-04</b>	<b>7.50E-04</b>	<b>7.50E-04</b>	<b>7.50E-04</b>
Status	PASS	PASS	PASS	PASS	PASS	PASS	PASS

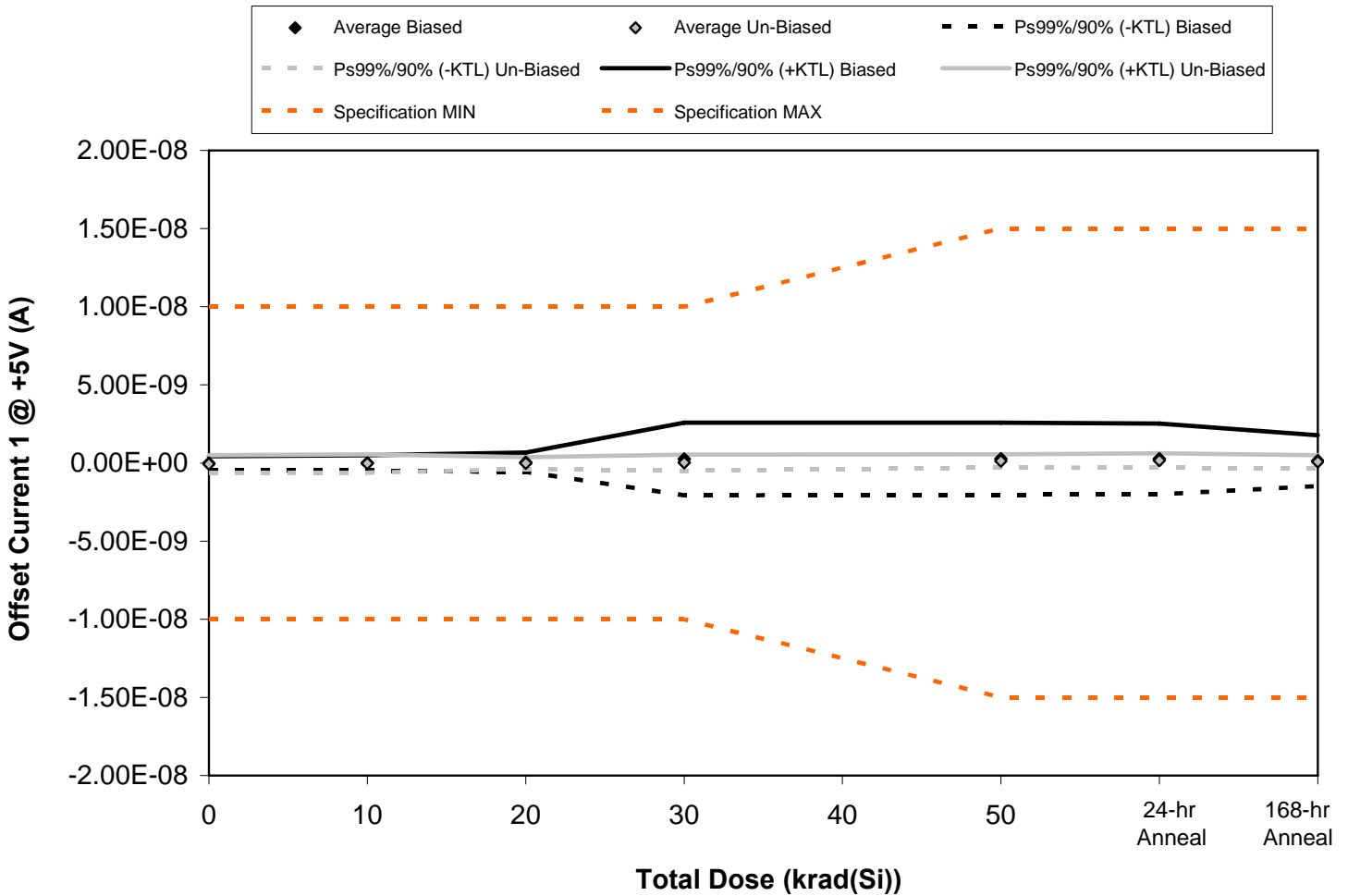

Figure 5.53. Plot of Offset Current 1 @ +5V (A) versus total dose. The data show no significant degradation with radiation. The solid diamonds are the average of measured data points from the biased sample (devices irradiated with an electrical bias) while the shaded diamonds are the average from the unbiased sample. The black lines show the effects on the data after application of the biased KTL statistics (solid and dashed lines) while the gray lines show the effects on the data after application of the unbiased KTL statistics (solid and dashed lines). The red dashed lines are the minimum and maximum specification values as defined in the datasheet and/or test plan.





Table 5.53. Raw data for Offset Current 1 @ +5V (A) versus total dose, including the statistical analysis, the specification and the status of the testing (pass/fail).

Offset Current 1 @ +5V (A)	Total Dose (krad(Si))					24-hr Anneal	168-hr Anneal
	0	10	20	30	50		
Device							
1027	1.14E-10	1.49E-10	1.81E-10	1.46E-10	1.72E-10	2.01E-10	-3.60E-11
1029	1.80E-11	7.40E-11	-3.40E-11	0.00E+00	-2.30E-11	-3.00E-11	4.70E-11
1030	-3.60E-11	-4.40E-11	1.60E-10	1.13E-09	1.14E-09	1.12E-09	7.73E-10
1031	-1.42E-10	-1.16E-10	-1.37E-10	-5.70E-11	4.00E-12	-2.00E-12	-2.60E-11
1032	0.00E+00	-2.60E-11	7.40E-11	3.10E-11	4.30E-11	5.40E-11	-6.00E-12
1033	-8.30E-11	-4.70E-11	-1.40E-11	-1.70E-11	5.90E-11	1.00E-10	9.60E-11
1034	-1.64E-10	-1.42E-10	-1.90E-11	1.50E-11	1.64E-10	1.92E-10	-5.80E-11
1035	1.38E-10	1.67E-10	1.23E-10	1.84E-10	2.46E-10	3.16E-10	1.58E-10
1036	-1.52E-10	-1.33E-10	-1.00E-10	-1.23E-10	1.60E-11	6.10E-11	4.50E-11
1038	-5.10E-11	-1.30E-11	-5.00E-11	3.10E-11	1.33E-10	1.34E-10	1.54E-10
1039	-1.80E-11	-1.50E-11	-2.10E-11	-1.70E-11	-3.30E-11	-2.80E-11	-4.00E-11
<b>Biased Statistics</b>							
Average Biased	-9.20E-12	7.40E-12	4.88E-11	2.50E-10	2.67E-10	2.69E-10	1.50E-10
Std Dev Biased	9.27E-11	1.04E-10	1.34E-10	4.98E-10	4.94E-10	4.85E-10	3.50E-10
Ps99%/90% (+KTL) Biased	4.23E-10	4.94E-10	6.74E-10	2.58E-09	2.57E-09	2.53E-09	1.78E-09
Ps99%/90% (-KTL) Biased	-4.42E-10	-4.79E-10	-5.77E-10	-2.07E-09	-2.04E-09	-1.99E-09	-1.48E-09
<b>Un-Biased Statistics</b>							
Average Un-Biased	-6.24E-11	-3.36E-11	-1.20E-11	1.80E-11	1.24E-10	1.61E-10	7.90E-11
Std Dev Un-Biased	1.22E-10	1.25E-10	8.29E-11	1.10E-10	9.01E-11	9.93E-11	8.96E-11
Ps99%/90% (+KTL) Un-Biased	5.05E-10	5.50E-10	3.75E-10	5.34E-10	5.44E-10	6.24E-10	4.97E-10
Ps99%/90% (-KTL) Un-Biased	-6.29E-10	-6.17E-10	-3.99E-10	-4.98E-10	-2.97E-10	-3.03E-10	-3.39E-10
<b>Specification MIN</b>	<b>-1.00E-08</b>	<b>-1.00E-08</b>	<b>-1.00E-08</b>	<b>-1.00E-08</b>	<b>-1.50E-08</b>	<b>-1.50E-08</b>	<b>-1.50E-08</b>
Status	PASS	PASS	PASS	PASS	PASS	PASS	PASS
<b>Specification MAX</b>	<b>1.00E-08</b>	<b>1.00E-08</b>	<b>1.00E-08</b>	<b>1.00E-08</b>	<b>1.50E-08</b>	<b>1.50E-08</b>	<b>1.50E-08</b>
Status	PASS	PASS	PASS	PASS	PASS	PASS	PASS

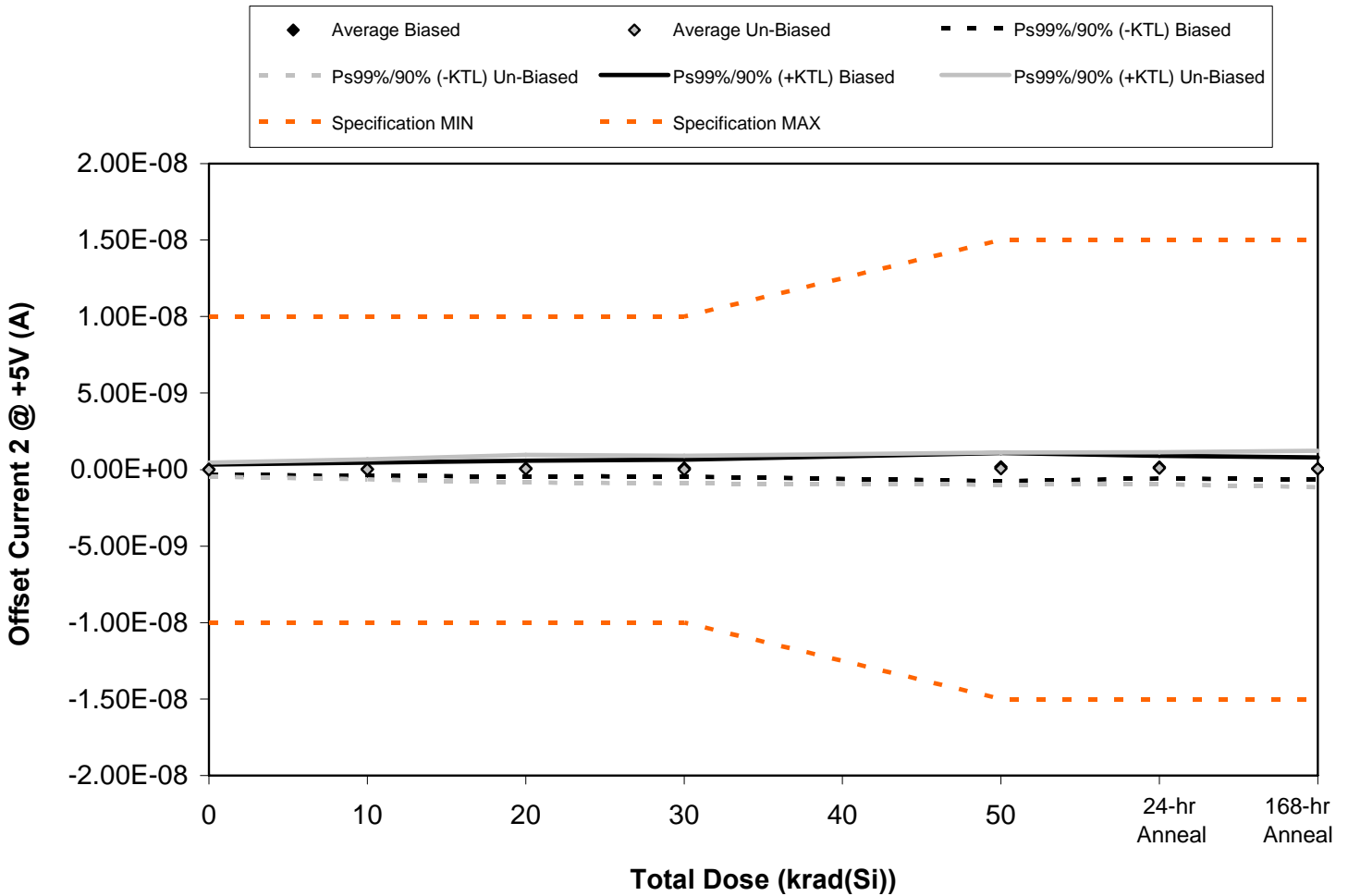

Figure 5.54. Plot of Offset Current 2 @ +5V (A) versus total dose. The data show no significant degradation with radiation. The solid diamonds are the average of measured data points from the biased sample (devices irradiated with an electrical bias) while the shaded diamonds are the average from the unbiased sample. The black lines show the effects on the data after application of the biased KTL statistics (solid and dashed lines) while the gray lines show the effects on the data after application of the unbiased KTL statistics (solid and dashed lines). The red dashed lines are the minimum and maximum specification values as defined in the datasheet and/or test plan.



Table 5.54. Raw data for Offset Current 2 @ +5V (A) versus total dose, including the statistical analysis, the specification and the status of the testing (pass/fail).

Offset Current 2 @ +5V (A)	Total Dose (krad(Si))					24-hr Anneal	168-hr Anneal
	0	10	20	30	50		
Device							
1027	-3.30E-11	-5.30E-11	3.50E-11	3.70E-11	9.00E-12	7.00E-11	-7.00E-12
1029	-8.80E-11	-1.07E-10	-6.20E-11	-3.00E-12	4.60E-11	5.60E-11	-1.06E-10
1030	2.20E-11	9.10E-11	1.90E-11	3.60E-11	4.00E-12	9.00E-12	-3.50E-11
1031	1.00E-11	1.06E-10	1.87E-10	1.75E-10	3.66E-10	2.96E-10	2.52E-10
1032	1.02E-10	6.40E-11	1.86E-10	2.79E-10	3.85E-10	3.64E-10	2.00E-10
1033	7.90E-11	1.52E-10	1.89E-10	1.63E-10	1.64E-10	1.89E-10	1.49E-10
1034	-1.48E-10	-2.17E-10	-2.86E-10	-2.89E-10	-3.05E-10	-2.63E-10	-3.88E-10
1035	9.30E-11	8.20E-11	1.32E-10	1.88E-10	3.01E-10	3.41E-10	2.70E-10
1036	-4.20E-11	4.90E-11	1.47E-10	3.10E-11	8.10E-11	9.30E-11	1.42E-10
1038	-2.20E-11	1.40E-11	5.60E-11	-5.90E-11	9.60E-11	8.80E-11	6.00E-12
1039	2.00E-11	6.00E-12	-4.00E-12	5.00E-12	-1.10E-11	7.00E-12	1.10E-11
<b>Biased Statistics</b>							
Average Biased	2.60E-12	2.02E-11	7.30E-11	1.05E-10	1.62E-10	1.59E-10	6.08E-11
Std Dev Biased	7.03E-11	9.46E-11	1.10E-10	1.19E-10	1.96E-10	1.60E-10	1.56E-10
Ps99%/90% (+KTL) Biased	3.31E-10	4.62E-10	5.86E-10	6.58E-10	1.08E-09	9.03E-10	7.89E-10
Ps99%/90% (-KTL) Biased	-3.26E-10	-4.21E-10	-4.40E-10	-4.48E-10	-7.51E-10	-5.85E-10	-6.68E-10
<b>Un-Biased Statistics</b>							
Average Un-Biased	-8.00E-12	1.60E-11	4.76E-11	6.80E-12	6.74E-11	8.96E-11	3.58E-11
Std Dev Un-Biased	9.84E-11	1.40E-10	1.93E-10	1.93E-10	2.26E-10	2.22E-10	2.55E-10
Ps99%/90% (+KTL) Un-Biased	4.51E-10	6.69E-10	9.46E-10	9.09E-10	1.12E-09	1.13E-09	1.22E-09
Ps99%/90% (-KTL) Un-Biased	-4.67E-10	-6.37E-10	-8.51E-10	-8.96E-10	-9.85E-10	-9.47E-10	-1.15E-09
<b>Specification MIN</b>	<b>-1.00E-08</b>	<b>-1.00E-08</b>	<b>-1.00E-08</b>	<b>-1.00E-08</b>	<b>-1.50E-08</b>	<b>-1.50E-08</b>	<b>-1.50E-08</b>
Status	PASS	PASS	PASS	PASS	PASS	PASS	PASS
<b>Specification MAX</b>	<b>1.00E-08</b>	<b>1.00E-08</b>	<b>1.00E-08</b>	<b>1.00E-08</b>	<b>1.50E-08</b>	<b>1.50E-08</b>	<b>1.50E-08</b>
Status	PASS	PASS	PASS	PASS	PASS	PASS	PASS

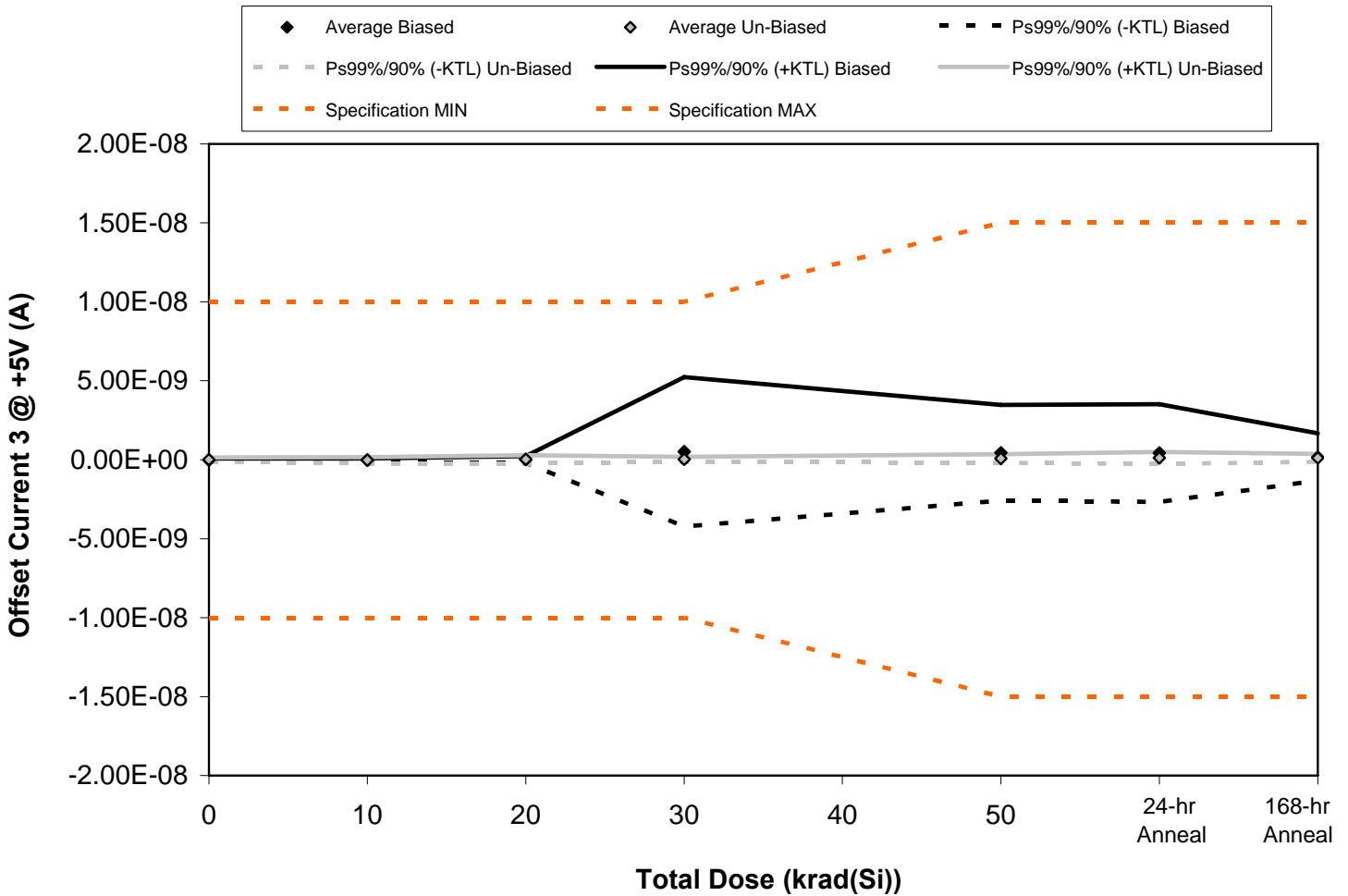

Figure 5.55. Plot of Offset Current 3 @ +5V (A) versus total dose. The data show no significant degradation with radiation. The solid diamonds are the average of measured data points from the biased sample (devices irradiated with an electrical bias) while the shaded diamonds are the average from the unbiased sample. The black lines show the effects on the data after application of the biased KTL statistics (solid and dashed lines) while the gray lines show the effects on the data after application of the unbiased KTL statistics (solid and dashed lines). The red dashed lines are the minimum and maximum specification values as defined in the datasheet and/or test plan.



Table 5.55. Raw data for Offset Current 3 @ +5V (A) versus total dose, including the statistical analysis, the specification and the status of the testing (pass/fail).

Offset Current 3 @ +5V (A)	Total Dose (krad(Si))					24-hr Anneal	168-hr Anneal
	0	10	20	30	50		
Device							
1027	-1.50E-11	-5.00E-11	-2.30E-11	-5.60E-11	3.30E-11	2.20E-11	-2.00E-12
1029	1.00E-12	7.00E-12	3.70E-11	9.00E-11	1.55E-10	1.14E-10	-8.00E-12
1030	-3.80E-11	-4.40E-11	-5.70E-11	2.32E-09	1.59E-09	1.60E-09	7.36E-10
1031	-5.80E-11	-3.10E-11	4.10E-11	1.07E-10	1.70E-10	1.38E-10	1.22E-10
1032	-3.30E-11	-4.30E-11	5.10E-11	7.10E-11	2.50E-10	2.52E-10	4.00E-12
1033	5.00E-11	1.10E-11	6.40E-11	3.90E-11	7.40E-11	1.41E-10	1.90E-10
1034	-4.00E-12	-2.90E-11	5.90E-11	5.00E-12	-1.00E-11	-2.80E-11	1.15E-10
1035	1.10E-11	-3.00E-11	-1.40E-11	-1.60E-11	7.40E-11	1.31E-10	5.20E-11
1036	9.00E-12	-3.00E-12	6.60E-11	7.20E-11	9.60E-11	1.79E-10	1.48E-10
1038	-3.50E-11	-9.80E-11	-5.90E-11	3.10E-11	1.57E-10	1.44E-10	9.30E-11
1039	3.00E-12	0.00E+00	3.00E-12	1.10E-11	1.40E-11	-2.00E-11	0.00E+00
<b>Biased Statistics</b>							
Average Biased	-2.86E-11	-3.22E-11	9.80E-12	5.06E-10	4.40E-10	4.25E-10	1.70E-10
Std Dev Biased	2.25E-11	2.30E-11	4.73E-11	1.01E-09	6.49E-10	6.62E-10	3.21E-10
Ps99%/90% (+KTL) Biased	7.66E-11	7.50E-11	2.30E-10	5.24E-09	3.47E-09	3.52E-09	1.67E-09
Ps99%/90% (-KTL) Biased	-1.34E-10	-1.39E-10	-2.11E-10	-4.23E-09	-2.59E-09	-2.66E-09	-1.33E-09
<b>Un-Biased Statistics</b>							
Average Un-Biased	6.20E-12	-2.98E-11	2.32E-11	2.62E-11	7.82E-11	1.13E-10	1.20E-10
Std Dev Un-Biased	3.06E-11	4.19E-11	5.68E-11	3.36E-11	5.99E-11	8.11E-11	5.26E-11
Ps99%/90% (+KTL) Un-Biased	1.49E-10	1.66E-10	2.88E-10	1.83E-10	3.58E-10	4.92E-10	3.65E-10
Ps99%/90% (-KTL) Un-Biased	-1.37E-10	-2.25E-10	-2.42E-10	-1.31E-10	-2.01E-10	-2.65E-10	-1.26E-10
<b>Specification MIN</b>	<b>-1.00E-08</b>	<b>-1.00E-08</b>	<b>-1.00E-08</b>	<b>-1.00E-08</b>	<b>-1.50E-08</b>	<b>-1.50E-08</b>	<b>-1.50E-08</b>
Status	PASS	PASS	PASS	PASS	PASS	PASS	PASS
<b>Specification MAX</b>	<b>1.00E-08</b>	<b>1.00E-08</b>	<b>1.00E-08</b>	<b>1.00E-08</b>	<b>1.50E-08</b>	<b>1.50E-08</b>	<b>1.50E-08</b>
Status	PASS	PASS	PASS	PASS	PASS	PASS	PASS

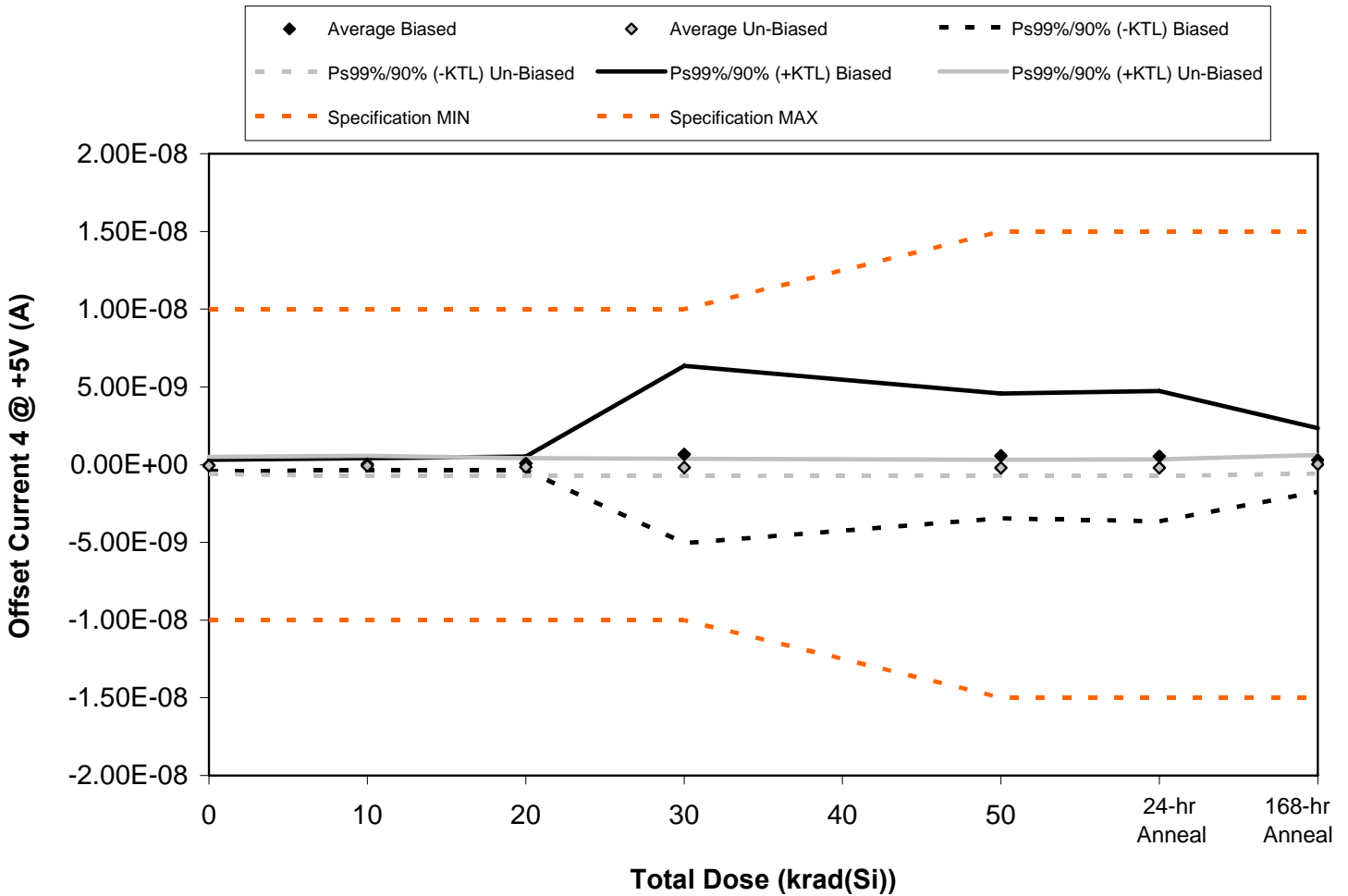

Figure 5.56. Plot of Offset Current 4 @ +5V (A) versus total dose. The data show no significant degradation with radiation. The solid diamonds are the average of measured data points from the biased sample (devices irradiated with an electrical bias) while the shaded diamonds are the average from the unbiased sample. The black lines show the effects on the data after application of the biased KTL statistics (solid and dashed lines) while the gray lines show the effects on the data after application of the unbiased KTL statistics (solid and dashed lines). The red dashed lines are the minimum and maximum specification values as defined in the datasheet and/or test plan.



Table 5.56. Raw data for Offset Current 4 @ +5V (A) versus total dose, including the statistical analysis, the specification and the status of the testing (pass/fail).

Offset Current 4 @ +5V (A)	Total Dose (krad(Si))					24-hr Anneal	168-hr Anneal
	0	10	20	30	50		
Device							
1027	6.40E-11	1.35E-10	2.11E-10	1.58E-10	2.53E-10	1.92E-10	1.14E-10
1029	-5.50E-11	-7.40E-11	-2.10E-11	1.88E-10	2.55E-10	1.80E-10	2.70E-10
1030	-3.80E-11	7.00E-12	3.90E-11	2.83E-09	2.09E-09	2.14E-09	1.01E-09
1031	-3.70E-11	8.00E-11	1.37E-10	2.10E-10	2.48E-10	2.60E-10	2.66E-10
1032	-1.44E-10	-3.60E-11	1.30E-11	-1.05E-10	-2.20E-11	-5.30E-11	-1.80E-10
1033	8.00E-12	-3.20E-11	-1.56E-10	-1.79E-10	-2.10E-10	-1.77E-10	5.10E-11
1034	-1.00E-11	5.60E-11	-9.80E-11	-1.26E-10	-1.82E-10	-9.00E-11	1.39E-10
1035	4.50E-11	1.00E-11	-1.10E-11	-1.70E-11	-5.10E-11	-1.35E-10	1.39E-10
1036	-2.56E-10	-2.84E-10	-3.47E-10	-3.37E-10	-3.50E-10	-3.90E-10	-1.52E-10
1038	-6.10E-11	-1.64E-10	-1.76E-10	-2.33E-10	-1.83E-10	-1.98E-10	-6.00E-11
1039	-8.00E-11	-7.50E-11	-6.80E-11	-7.10E-11	-6.00E-11	-7.70E-11	-6.80E-11
<b>Biased Statistics</b>							
Average Biased	-4.20E-11	2.24E-11	7.58E-11	6.56E-10	5.64E-10	5.43E-10	2.96E-10
Std Dev Biased	7.39E-11	8.51E-11	9.58E-11	1.22E-09	8.59E-10	8.98E-10	4.39E-10
Ps99%/90% (+KTL) Biased	3.03E-10	4.19E-10	5.23E-10	6.35E-09	4.57E-09	4.73E-09	2.34E-09
Ps99%/90% (-KTL) Biased	-3.87E-10	-3.74E-10	-3.71E-10	-5.04E-09	-3.44E-09	-3.65E-09	-1.75E-09
<b>Un-Biased Statistics</b>							
Average Un-Biased	-5.48E-11	-8.28E-11	-1.58E-10	-1.78E-10	-1.95E-10	-1.98E-10	2.34E-11
Std Dev Un-Biased	1.19E-10	1.39E-10	1.24E-10	1.19E-10	1.06E-10	1.15E-10	1.28E-10
Ps99%/90% (+KTL) Un-Biased	4.99E-10	5.67E-10	4.20E-10	3.78E-10	3.01E-10	3.39E-10	6.19E-10
Ps99%/90% (-KTL) Un-Biased	-6.09E-10	-7.32E-10	-7.35E-10	-7.35E-10	-6.92E-10	-7.35E-10	-5.72E-10
<b>Specification MIN</b>	<b>-1.00E-08</b>	<b>-1.00E-08</b>	<b>-1.00E-08</b>	<b>-1.00E-08</b>	<b>-1.50E-08</b>	<b>-1.50E-08</b>	<b>-1.50E-08</b>
Status	PASS	PASS	PASS	PASS	PASS	PASS	PASS
<b>Specification MAX</b>	<b>1.00E-08</b>	<b>1.00E-08</b>	<b>1.00E-08</b>	<b>1.00E-08</b>	<b>1.50E-08</b>	<b>1.50E-08</b>	<b>1.50E-08</b>
Status	PASS	PASS	PASS	PASS	PASS	PASS	PASS

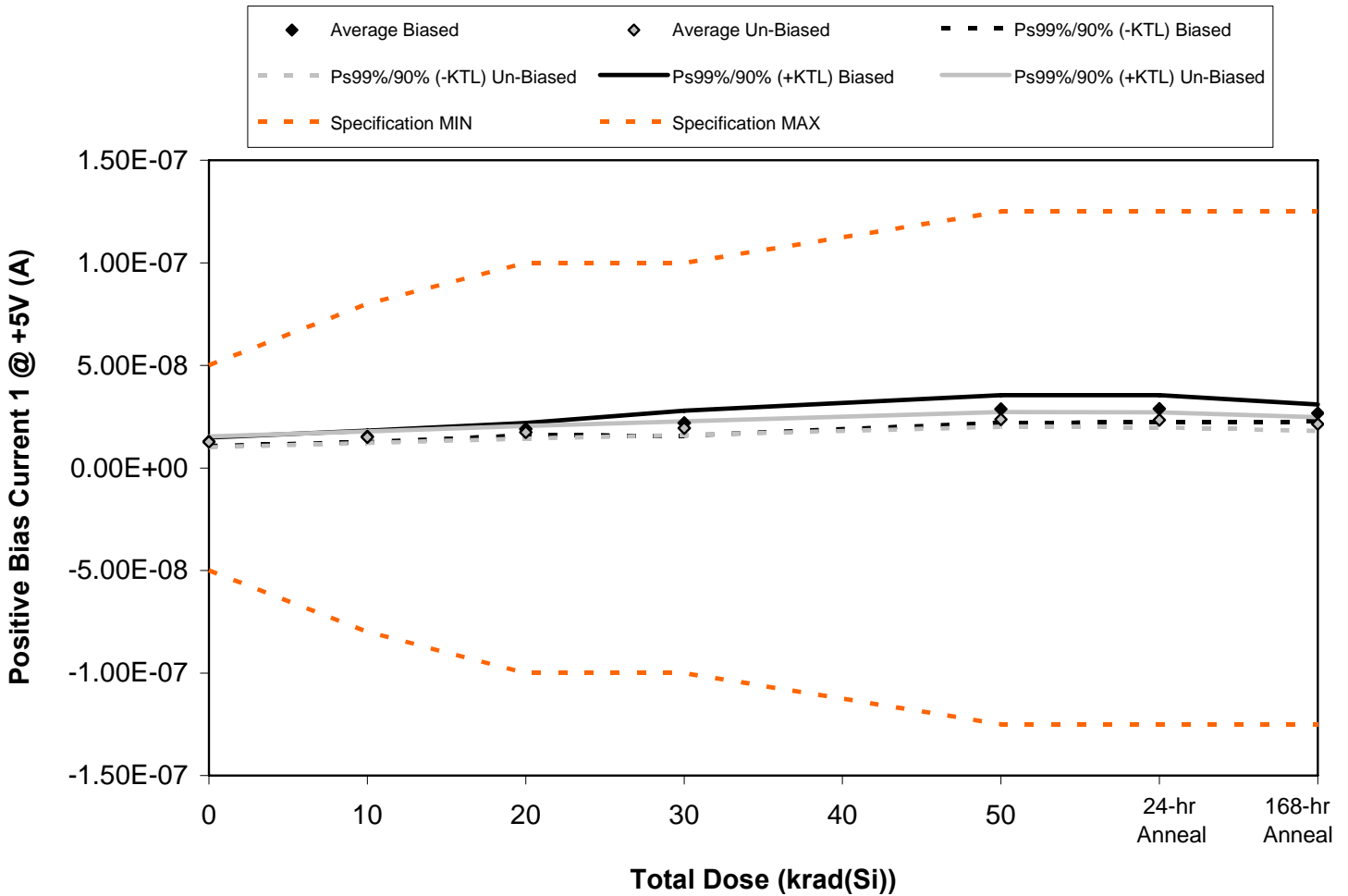

Figure 5.57. Plot of Positive Bias Current 1 @ +/-5V (A) versus total dose. The data show no significant degradation with radiation. The solid diamonds are the average of measured data points from the biased sample (devices irradiated with an electrical bias) while the shaded diamonds are the average from the unbiased sample. The black lines show the effects on the data after application of the biased KTL statistics (solid and dashed lines) while the gray lines show the effects on the data after application of the unbiased KTL statistics (solid and dashed lines). The red dashed lines are the minimum and maximum specification values as defined in the datasheet and/or test plan.





Table 5.57. Raw data for Positive Bias Current 1 @ +/-5V (A) versus total dose, including the statistical analysis, the specification and the status of the testing (pass/fail).

Positive Bias Current 1 @ +5V (A)	Total Dose (krad(Si))					24-hr Anneal	168-hr Anneal
	0	10	20	30	50		
Device							
1027	1.32E-08	1.61E-08	1.98E-08	2.32E-08	3.05E-08	3.05E-08	2.78E-08
1029	1.21E-08	1.44E-08	1.80E-08	2.11E-08	2.78E-08	2.79E-08	2.56E-08
1030	1.28E-08	1.52E-08	1.87E-08	1.99E-08	2.68E-08	2.69E-08	2.61E-08
1031	1.29E-08	1.55E-08	1.91E-08	2.24E-08	2.92E-08	2.93E-08	2.70E-08
1032	1.30E-08	1.56E-08	1.92E-08	2.25E-08	2.93E-08	2.94E-08	2.74E-08
1033	1.28E-08	1.50E-08	1.75E-08	1.95E-08	2.37E-08	2.35E-08	2.14E-08
1034	1.23E-08	1.46E-08	1.68E-08	1.88E-08	2.30E-08	2.28E-08	2.07E-08
1035	1.21E-08	1.43E-08	1.67E-08	1.86E-08	2.28E-08	2.27E-08	2.07E-08
1036	1.36E-08	1.59E-08	1.83E-08	2.04E-08	2.48E-08	2.46E-08	2.25E-08
1038	1.28E-08	1.50E-08	1.75E-08	1.95E-08	2.38E-08	2.36E-08	2.15E-08
1039	1.19E-08	1.20E-08	1.20E-08	1.19E-08	1.19E-08	1.19E-08	1.19E-08
<b>Biased Statistics</b>							
Average Biased	1.28E-08	1.54E-08	1.90E-08	2.18E-08	2.87E-08	2.88E-08	2.68E-08
Std Dev Biased	4.34E-10	6.03E-10	6.41E-10	1.30E-09	1.44E-09	1.44E-09	8.91E-10
Ps99%/90% (+KTL) Biased	1.48E-08	1.82E-08	2.19E-08	2.79E-08	3.54E-08	3.55E-08	3.09E-08
Ps99%/90% (-KTL) Biased	1.08E-08	1.25E-08	1.60E-08	1.58E-08	2.20E-08	2.21E-08	2.26E-08
<b>Un-Biased Statistics</b>							
Average Un-Biased	1.27E-08	1.50E-08	1.74E-08	1.94E-08	2.36E-08	2.34E-08	2.14E-08
Std Dev Un-Biased	5.67E-10	6.09E-10	6.57E-10	7.05E-10	7.80E-10	7.78E-10	7.24E-10
Ps99%/90% (+KTL) Un-Biased	1.54E-08	1.78E-08	2.04E-08	2.27E-08	2.72E-08	2.71E-08	2.48E-08
Ps99%/90% (-KTL) Un-Biased	1.01E-08	1.21E-08	1.43E-08	1.61E-08	2.00E-08	1.98E-08	1.80E-08
<b>Specification MIN</b>	<b>-5.00E-08</b>	<b>-8.00E-08</b>	<b>-1.00E-07</b>	<b>-1.00E-07</b>	<b>-1.25E-07</b>	<b>-1.25E-07</b>	<b>-1.25E-07</b>
Status	PASS	PASS	PASS	PASS	PASS	PASS	PASS
<b>Specification MAX</b>	<b>5.00E-08</b>	<b>8.00E-08</b>	<b>1.00E-07</b>	<b>1.00E-07</b>	<b>1.25E-07</b>	<b>1.25E-07</b>	<b>1.25E-07</b>
Status	PASS	PASS	PASS	PASS	PASS	PASS	PASS

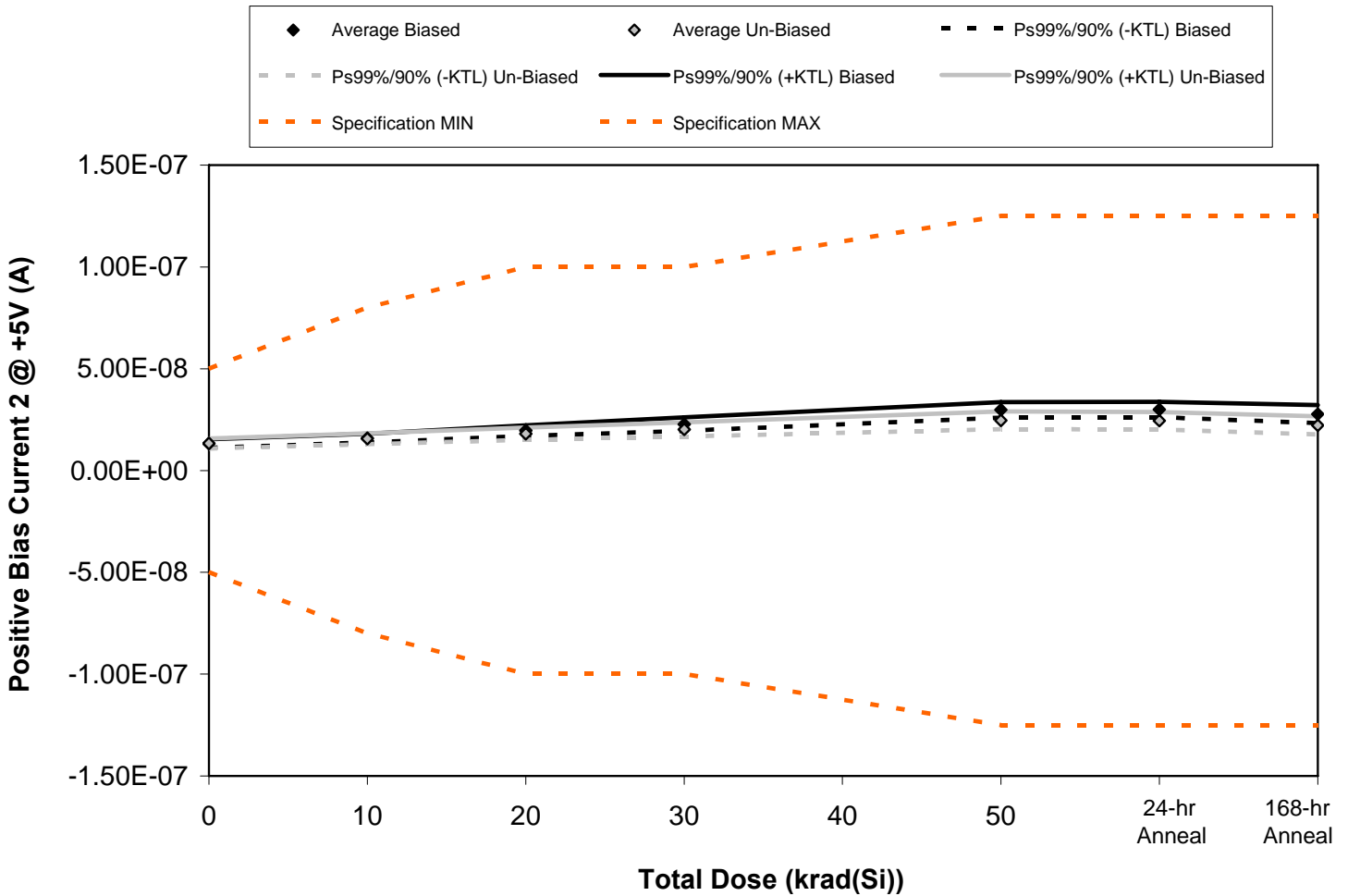

Figure 5.58. Plot of Positive Bias Current 2 @ +/-5V (A) versus total dose. The data show no significant degradation with radiation. The solid diamonds are the average of measured data points from the biased sample (devices irradiated with an electrical bias) while the shaded diamonds are the average from the unbiased sample. The black lines show the effects on the data after application of the biased KTL statistics (solid and dashed lines) while the gray lines show the effects on the data after application of the unbiased KTL statistics (solid and dashed lines). The red dashed lines are the minimum and maximum specification values as defined in the datasheet and/or test plan.



Table 5.58. Raw data for Positive Bias Current 2 @ +/-5V (A) versus total dose, including the statistical analysis, the specification and the status of the testing (pass/fail).

Positive Bias Current 2 @ +5V (A)	Total Dose (krad(Si))					24-hr Anneal	168-hr Anneal
	0	10	20	30	50		
Device							
1027	1.26E-08	1.53E-08	1.89E-08	2.21E-08	2.90E-08	2.91E-08	2.63E-08
1029	1.37E-08	1.63E-08	2.01E-08	2.34E-08	3.05E-08	3.06E-08	2.86E-08
1030	1.32E-08	1.58E-08	1.93E-08	2.21E-08	2.90E-08	2.91E-08	2.74E-08
1031	1.31E-08	1.58E-08	1.94E-08	2.28E-08	2.98E-08	3.00E-08	2.75E-08
1032	1.36E-08	1.64E-08	2.03E-08	2.36E-08	3.07E-08	3.09E-08	2.86E-08
1033	1.35E-08	1.58E-08	1.82E-08	2.02E-08	2.47E-08	2.45E-08	2.23E-08
1034	1.33E-08	1.57E-08	1.83E-08	2.03E-08	2.48E-08	2.46E-08	2.24E-08
1035	1.24E-08	1.47E-08	1.70E-08	1.90E-08	2.32E-08	2.30E-08	2.07E-08
1036	1.34E-08	1.56E-08	1.81E-08	2.03E-08	2.47E-08	2.46E-08	2.23E-08
1038	1.38E-08	1.62E-08	1.88E-08	2.11E-08	2.58E-08	2.56E-08	2.33E-08
1039	1.20E-08	1.21E-08	1.21E-08	1.20E-08	1.20E-08	1.20E-08	1.20E-08
<b>Biased Statistics</b>							
Average Biased	1.32E-08	1.59E-08	1.96E-08	2.28E-08	2.98E-08	2.99E-08	2.77E-08
Std Dev Biased	4.40E-10	4.55E-10	5.65E-10	7.15E-10	8.15E-10	8.06E-10	9.48E-10
Ps99%/90% (+KTL) Biased	1.53E-08	1.80E-08	2.22E-08	2.61E-08	3.36E-08	3.37E-08	3.21E-08
Ps99%/90% (-KTL) Biased	1.12E-08	1.38E-08	1.69E-08	1.95E-08	2.60E-08	2.62E-08	2.33E-08
<b>Un-Biased Statistics</b>							
Average Un-Biased	1.33E-08	1.56E-08	1.81E-08	2.02E-08	2.46E-08	2.45E-08	2.22E-08
Std Dev Un-Biased	5.29E-10	5.69E-10	6.53E-10	7.57E-10	9.32E-10	9.14E-10	9.42E-10
Ps99%/90% (+KTL) Un-Biased	1.58E-08	1.83E-08	2.11E-08	2.37E-08	2.90E-08	2.87E-08	2.66E-08
Ps99%/90% (-KTL) Un-Biased	1.08E-08	1.30E-08	1.50E-08	1.67E-08	2.03E-08	2.02E-08	1.78E-08
<b>Specification MIN</b>	<b>-5.00E-08</b>	<b>-8.00E-08</b>	<b>-1.00E-07</b>	<b>-1.00E-07</b>	<b>-1.25E-07</b>	<b>-1.25E-07</b>	<b>-1.25E-07</b>
Status	PASS	PASS	PASS	PASS	PASS	PASS	PASS
<b>Specification MAX</b>	<b>5.00E-08</b>	<b>8.00E-08</b>	<b>1.00E-07</b>	<b>1.00E-07</b>	<b>1.25E-07</b>	<b>1.25E-07</b>	<b>1.25E-07</b>
Status	PASS	PASS	PASS	PASS	PASS	PASS	PASS

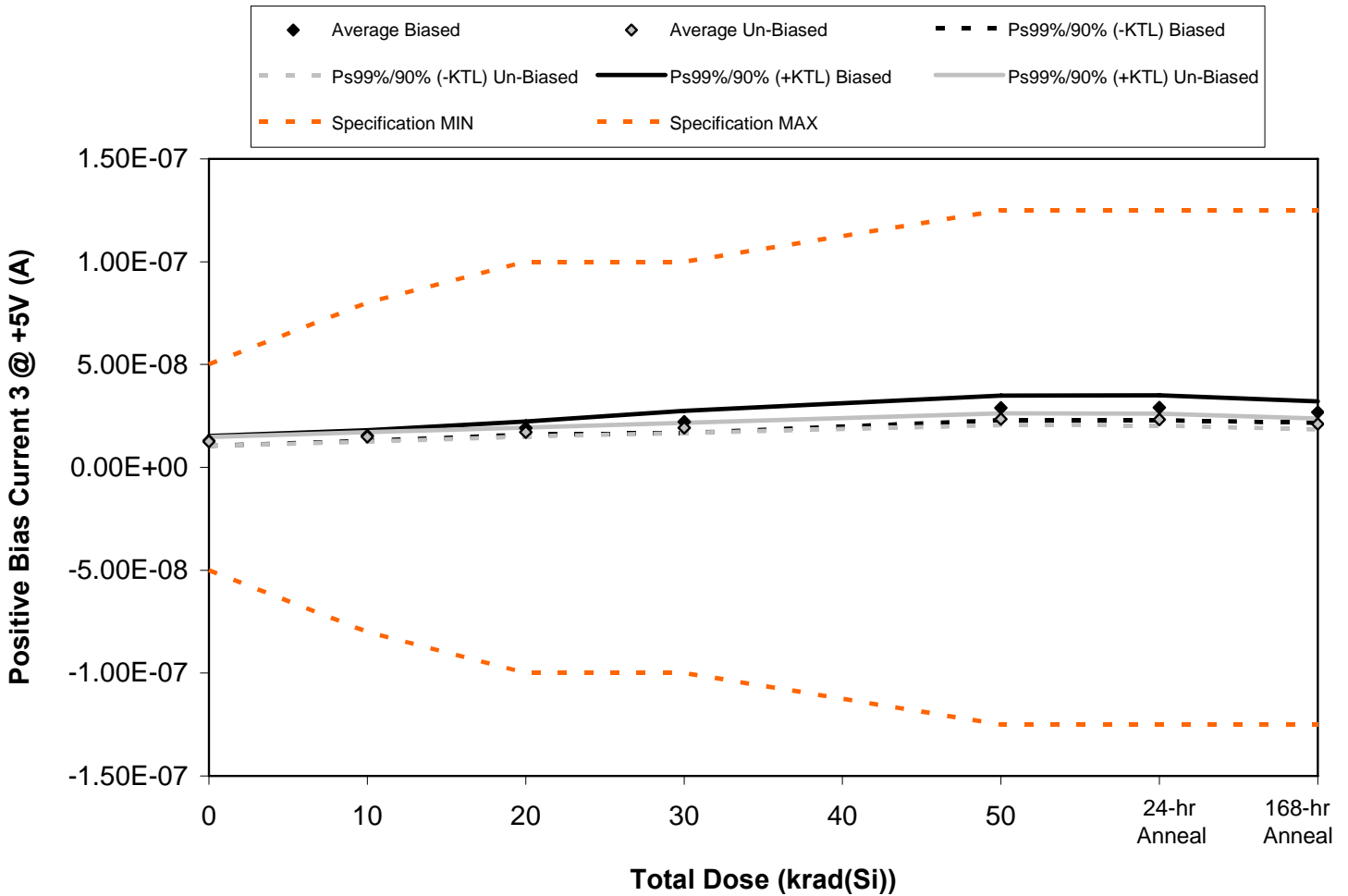

Figure 5.59. Plot of Positive Bias Current 3 @ +/-5V (A) versus total dose. The data show no significant degradation with radiation. The solid diamonds are the average of measured data points from the biased sample (devices irradiated with an electrical bias) while the shaded diamonds are the average from the unbiased sample. The black lines show the effects on the data after application of the biased KTL statistics (solid and dashed lines) while the gray lines show the effects on the data after application of the unbiased KTL statistics (solid and dashed lines). The red dashed lines are the minimum and maximum specification values as defined in the datasheet and/or test plan.



Table 5.59. Raw data for Positive Bias Current 3 @ +/-5V (A) versus total dose, including the statistical analysis, the specification and the status of the testing (pass/fail).

Positive Bias Current 3 @ +5V (A)	Total Dose (krad(Si))					24-hr Anneal	168-hr Anneal
	0	10	20	30	50		
Device							
1027	1.21E-08	1.47E-08	1.83E-08	2.14E-08	2.80E-08	2.81E-08	2.54E-08
1029	1.31E-08	1.55E-08	1.92E-08	2.24E-08	2.92E-08	2.93E-08	2.73E-08
1030	1.26E-08	1.51E-08	1.85E-08	2.05E-08	2.72E-08	2.74E-08	2.59E-08
1031	1.34E-08	1.60E-08	1.98E-08	2.31E-08	3.01E-08	3.02E-08	2.77E-08
1032	1.32E-08	1.59E-08	1.97E-08	2.32E-08	3.02E-08	3.03E-08	2.80E-08
1033	1.31E-08	1.52E-08	1.75E-08	1.95E-08	2.38E-08	2.35E-08	2.14E-08
1034	1.25E-08	1.46E-08	1.70E-08	1.90E-08	2.33E-08	2.31E-08	2.09E-08
1035	1.20E-08	1.41E-08	1.64E-08	1.84E-08	2.24E-08	2.22E-08	2.01E-08
1036	1.30E-08	1.53E-08	1.76E-08	1.97E-08	2.40E-08	2.38E-08	2.15E-08
1038	1.26E-08	1.50E-08	1.73E-08	1.94E-08	2.37E-08	2.35E-08	2.14E-08
1039	1.16E-08	1.16E-08	1.16E-08	1.16E-08	1.15E-08	1.15E-08	1.15E-08
<b>Biased Statistics</b>							
Average Biased	1.29E-08	1.55E-08	1.91E-08	2.21E-08	2.89E-08	2.90E-08	2.69E-08
Std Dev Biased	5.13E-10	5.65E-10	6.80E-10	1.15E-09	1.28E-09	1.30E-09	1.13E-09
Ps99%/90% (+KTL) Biased	1.53E-08	1.81E-08	2.23E-08	2.75E-08	3.49E-08	3.51E-08	3.22E-08
Ps99%/90% (-KTL) Biased	1.05E-08	1.28E-08	1.59E-08	1.68E-08	2.29E-08	2.30E-08	2.16E-08
<b>Un-Biased Statistics</b>							
Average Un-Biased	1.26E-08	1.48E-08	1.72E-08	1.92E-08	2.34E-08	2.32E-08	2.11E-08
Std Dev Un-Biased	4.58E-10	5.01E-10	4.78E-10	5.26E-10	6.08E-10	6.15E-10	5.65E-10
Ps99%/90% (+KTL) Un-Biased	1.48E-08	1.72E-08	1.94E-08	2.17E-08	2.63E-08	2.61E-08	2.37E-08
Ps99%/90% (-KTL) Un-Biased	1.05E-08	1.25E-08	1.49E-08	1.68E-08	2.06E-08	2.04E-08	1.84E-08
<b>Specification MIN</b>	<b>-5.00E-08</b>	<b>-8.00E-08</b>	<b>-1.00E-07</b>	<b>-1.00E-07</b>	<b>-1.25E-07</b>	<b>-1.25E-07</b>	<b>-1.25E-07</b>
Status	PASS	PASS	PASS	PASS	PASS	PASS	PASS
<b>Specification MAX</b>	<b>5.00E-08</b>	<b>8.00E-08</b>	<b>1.00E-07</b>	<b>1.00E-07</b>	<b>1.25E-07</b>	<b>1.25E-07</b>	<b>1.25E-07</b>
Status	PASS	PASS	PASS	PASS	PASS	PASS	PASS

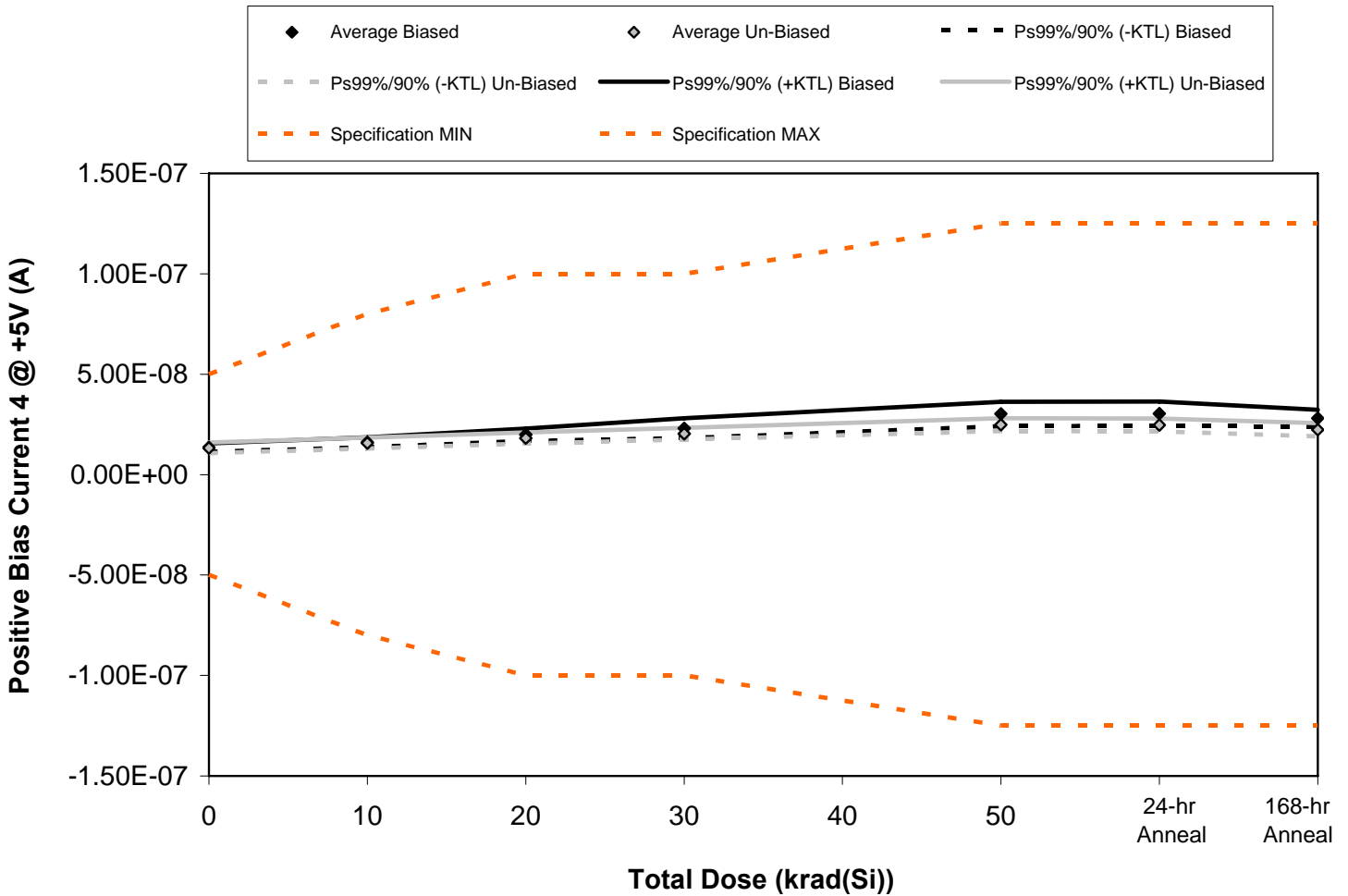

Figure 5.60. Plot of Positive Bias Current 4 @ +/-5V (A) versus total dose. The data show no significant degradation with radiation. The solid diamonds are the average of measured data points from the biased sample (devices irradiated with an electrical bias) while the shaded diamonds are the average from the unbiased sample. The black lines show the effects on the data after application of the biased KTL statistics (solid and dashed lines) while the gray lines show the effects on the data after application of the unbiased KTL statistics (solid and dashed lines). The red dashed lines are the minimum and maximum specification values as defined in the datasheet and/or test plan.



Table 5.60. Raw data for Positive Bias Current 4 @ +/-5V (A) versus total dose, including the statistical analysis, the specification and the status of the testing (pass/fail).

Positive Bias Current 4 @ +5V (A)	Total Dose (krad(Si))					24-hr Anneal	168-hr Anneal
	0	10	20	30	50		
Device							
1027	1.36E-08	1.66E-08	2.04E-08	2.40E-08	3.15E-08	3.17E-08	2.84E-08
1029	1.31E-08	1.57E-08	1.94E-08	2.26E-08	2.95E-08	2.96E-08	2.74E-08
1030	1.33E-08	1.57E-08	1.93E-08	2.17E-08	2.86E-08	2.87E-08	2.74E-08
1031	1.32E-08	1.59E-08	1.96E-08	2.29E-08	3.00E-08	3.01E-08	2.76E-08
1032	1.42E-08	1.68E-08	2.07E-08	2.42E-08	3.15E-08	3.17E-08	2.95E-08
1033	1.32E-08	1.55E-08	1.80E-08	2.02E-08	2.47E-08	2.45E-08	2.22E-08
1034	1.27E-08	1.50E-08	1.76E-08	1.97E-08	2.42E-08	2.40E-08	2.15E-08
1035	1.33E-08	1.57E-08	1.82E-08	2.02E-08	2.48E-08	2.46E-08	2.23E-08
1036	1.43E-08	1.66E-08	1.92E-08	2.14E-08	2.60E-08	2.58E-08	2.34E-08
1038	1.32E-08	1.55E-08	1.80E-08	2.02E-08	2.46E-08	2.45E-08	2.22E-08
1039	1.23E-08	1.24E-08	1.24E-08	1.24E-08	1.23E-08	1.24E-08	1.23E-08
<b>Biased Statistics</b>							
Average Biased	1.35E-08	1.61E-08	1.99E-08	2.31E-08	3.02E-08	3.04E-08	2.81E-08
Std Dev Biased	4.52E-10	5.20E-10	6.57E-10	1.05E-09	1.29E-09	1.30E-09	9.13E-10
Ps99%/90% (+KTL) Biased	1.56E-08	1.86E-08	2.30E-08	2.80E-08	3.62E-08	3.64E-08	3.23E-08
Ps99%/90% (-KTL) Biased	1.14E-08	1.37E-08	1.68E-08	1.82E-08	2.42E-08	2.43E-08	2.38E-08
<b>Un-Biased Statistics</b>							
Average Un-Biased	1.33E-08	1.57E-08	1.82E-08	2.03E-08	2.49E-08	2.47E-08	2.23E-08
Std Dev Un-Biased	5.75E-10	5.77E-10	6.01E-10	6.25E-10	6.91E-10	6.84E-10	7.02E-10
Ps99%/90% (+KTL) Un-Biased	1.60E-08	1.84E-08	2.10E-08	2.33E-08	2.81E-08	2.79E-08	2.56E-08
Ps99%/90% (-KTL) Un-Biased	1.06E-08	1.30E-08	1.54E-08	1.74E-08	2.17E-08	2.15E-08	1.90E-08
<b>Specification MIN</b>	<b>-5.00E-08</b>	<b>-8.00E-08</b>	<b>-1.00E-07</b>	<b>-1.00E-07</b>	<b>-1.25E-07</b>	<b>-1.25E-07</b>	<b>-1.25E-07</b>
Status	PASS	PASS	PASS	PASS	PASS	PASS	PASS
<b>Specification MAX</b>	<b>5.00E-08</b>	<b>8.00E-08</b>	<b>1.00E-07</b>	<b>1.00E-07</b>	<b>1.25E-07</b>	<b>1.25E-07</b>	<b>1.25E-07</b>
Status	PASS	PASS	PASS	PASS	PASS	PASS	PASS

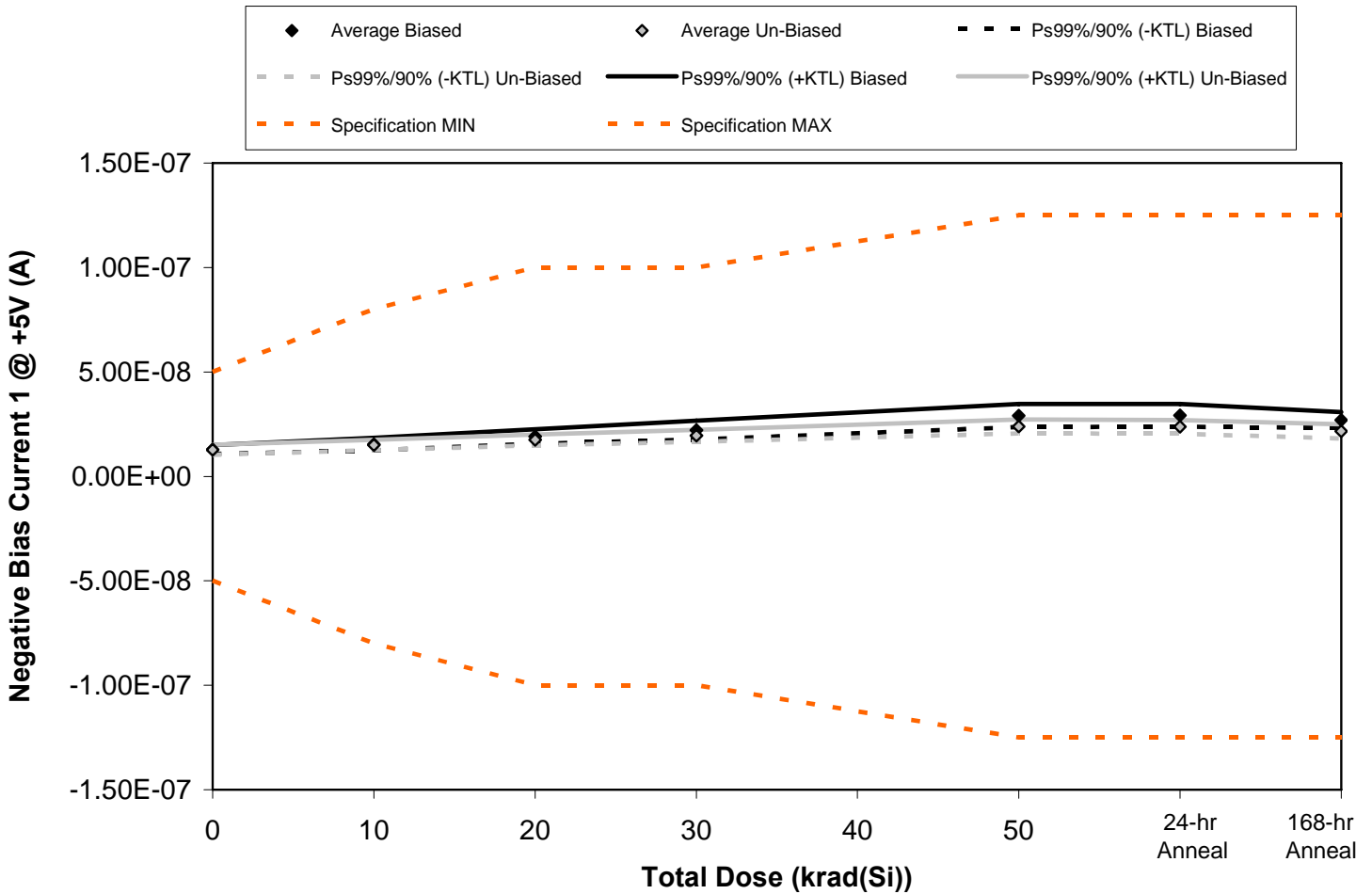

Figure 5.61. Plot of Negative Bias Current 1 @ +/-5V (A) versus total dose. The data show no significant degradation with radiation. The solid diamonds are the average of measured data points from the biased sample (devices irradiated with an electrical bias) while the shaded diamonds are the average from the unbiased sample. The black lines show the effects on the data after application of the biased KTL statistics (solid and dashed lines) while the gray lines show the effects on the data after application of the unbiased KTL statistics (solid and dashed lines). The red dashed lines are the minimum and maximum specification values as defined in the datasheet and/or test plan.





Table 5.61. Raw data for Negative Bias Current 1 @ +/-5V (A) versus total dose, including the statistical analysis, the specification and the status of the testing (pass/fail).

Negative Bias Current 1 @ +5V (A)	Total Dose (krad(Si))					24-hr Anneal	168-hr Anneal
	0	10	20	30	50		
Device							
1027	1.34E-08	1.63E-08	2.01E-08	2.34E-08	3.08E-08	3.09E-08	2.79E-08
1029	1.21E-08	1.45E-08	1.81E-08	2.12E-08	2.80E-08	2.80E-08	2.57E-08
1030	1.28E-08	1.53E-08	1.89E-08	2.12E-08	2.80E-08	2.81E-08	2.70E-08
1031	1.28E-08	1.54E-08	1.90E-08	2.24E-08	2.93E-08	2.94E-08	2.70E-08
1032	1.31E-08	1.56E-08	1.94E-08	2.26E-08	2.95E-08	2.96E-08	2.75E-08
1033	1.28E-08	1.50E-08	1.74E-08	1.95E-08	2.40E-08	2.37E-08	2.17E-08
1034	1.22E-08	1.45E-08	1.70E-08	1.89E-08	2.32E-08	2.31E-08	2.07E-08
1035	1.23E-08	1.45E-08	1.69E-08	1.90E-08	2.32E-08	2.31E-08	2.10E-08
1036	1.35E-08	1.58E-08	1.83E-08	2.04E-08	2.49E-08	2.48E-08	2.26E-08
1038	1.28E-08	1.51E-08	1.75E-08	1.96E-08	2.40E-08	2.38E-08	2.18E-08
1039	1.19E-08	1.20E-08	1.20E-08	1.19E-08	1.19E-08	1.19E-08	1.19E-08
<b>Biased Statistics</b>							
Average Biased	1.28E-08	1.54E-08	1.91E-08	2.22E-08	2.91E-08	2.92E-08	2.70E-08
Std Dev Biased	4.57E-10	6.36E-10	7.41E-10	9.75E-10	1.18E-09	1.18E-09	8.01E-10
Ps99%/90% (+KTL) Biased	1.50E-08	1.84E-08	2.25E-08	2.67E-08	3.46E-08	3.47E-08	3.07E-08
Ps99%/90% (-KTL) Biased	1.07E-08	1.25E-08	1.56E-08	1.76E-08	2.36E-08	2.37E-08	2.33E-08
<b>Un-Biased Statistics</b>							
Average Un-Biased	1.27E-08	1.50E-08	1.74E-08	1.95E-08	2.38E-08	2.37E-08	2.16E-08
Std Dev Un-Biased	5.02E-10	5.24E-10	5.67E-10	6.11E-10	7.07E-10	6.92E-10	7.24E-10
Ps99%/90% (+KTL) Un-Biased	1.51E-08	1.74E-08	2.01E-08	2.23E-08	2.71E-08	2.69E-08	2.49E-08
Ps99%/90% (-KTL) Un-Biased	1.04E-08	1.26E-08	1.48E-08	1.66E-08	2.05E-08	2.05E-08	1.82E-08
<b>Specification MIN</b>	<b>-5.00E-08</b>	<b>-8.00E-08</b>	<b>-1.00E-07</b>	<b>-1.00E-07</b>	<b>-1.25E-07</b>	<b>-1.25E-07</b>	<b>-1.25E-07</b>
Status	PASS	PASS	PASS	PASS	PASS	PASS	PASS
<b>Specification MAX</b>	<b>5.00E-08</b>	<b>8.00E-08</b>	<b>1.00E-07</b>	<b>1.00E-07</b>	<b>1.25E-07</b>	<b>1.25E-07</b>	<b>1.25E-07</b>
Status	PASS	PASS	PASS	PASS	PASS	PASS	PASS

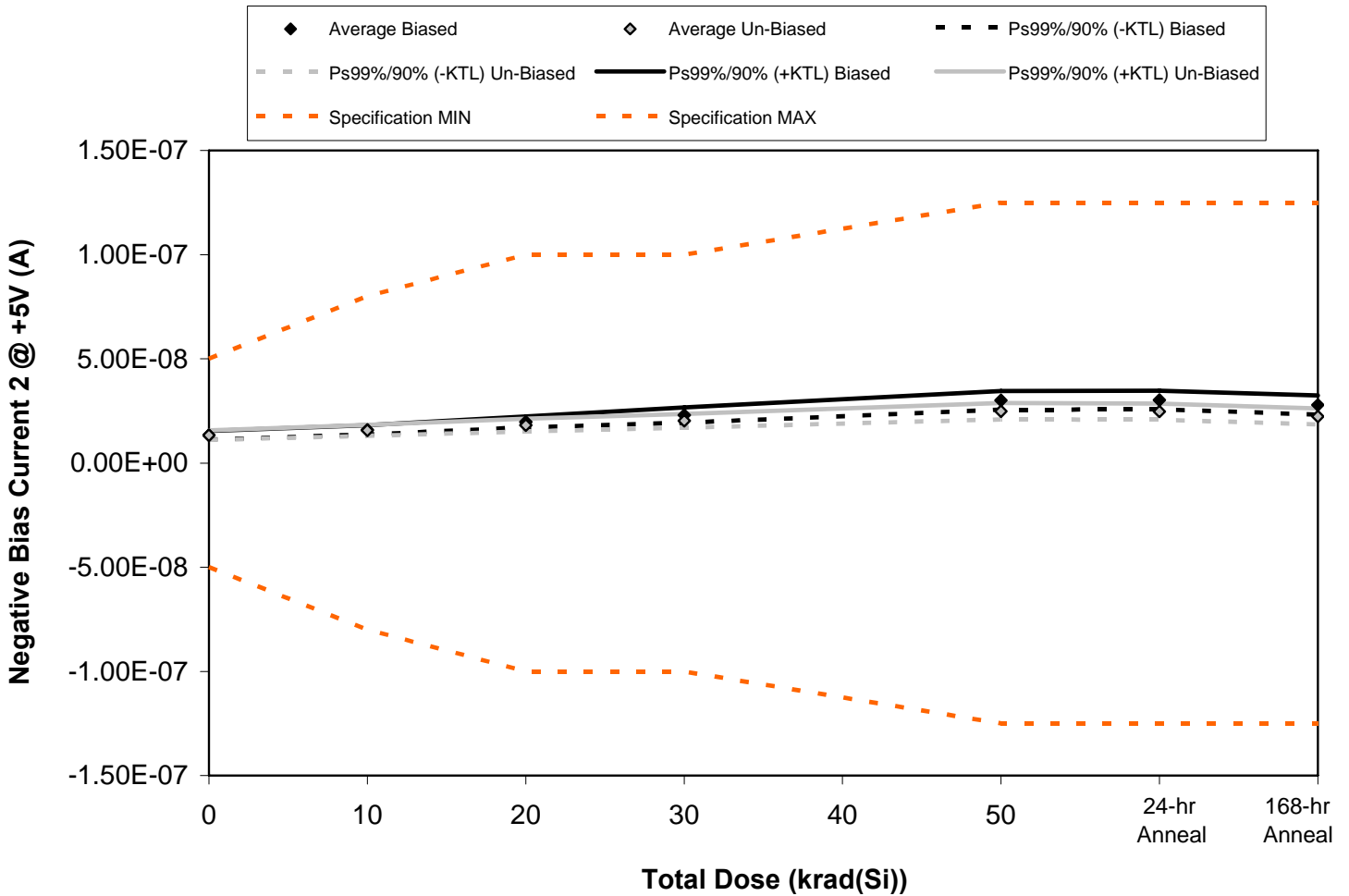

Figure 5.62. Plot of Negative Bias Current 2 @ +/-5V (A) versus total dose. The data show no significant degradation with radiation. The solid diamonds are the average of measured data points from the biased sample (devices irradiated with an electrical bias) while the shaded diamonds are the average from the unbiased sample. The black lines show the effects on the data after application of the biased KTL statistics (solid and dashed lines) while the gray lines show the effects on the data after application of the unbiased KTL statistics (solid and dashed lines). The red dashed lines are the minimum and maximum specification values as defined in the datasheet and/or test plan.



Table 5.62. Raw data for Negative Bias Current 2 @ +/-5V (A) versus total dose, including the statistical analysis, the specification and the status of the testing (pass/fail).

Negative Bias Current 2 @ +5V (A)	Total Dose (krad(Si))					24-hr Anneal	168-hr Anneal
	0	10	20	30	50		
Device							
1027	1.26E-08	1.52E-08	1.90E-08	2.22E-08	2.91E-08	2.92E-08	2.64E-08
1029	1.36E-08	1.62E-08	2.01E-08	2.35E-08	3.06E-08	3.08E-08	2.86E-08
1030	1.33E-08	1.59E-08	1.95E-08	2.22E-08	2.91E-08	2.93E-08	2.75E-08
1031	1.32E-08	1.60E-08	1.97E-08	2.31E-08	3.03E-08	3.03E-08	2.78E-08
1032	1.37E-08	1.65E-08	2.05E-08	2.40E-08	3.13E-08	3.14E-08	2.89E-08
1033	1.37E-08	1.60E-08	1.84E-08	2.05E-08	2.49E-08	2.48E-08	2.25E-08
1034	1.33E-08	1.56E-08	1.81E-08	2.01E-08	2.46E-08	2.45E-08	2.21E-08
1035	1.26E-08	1.48E-08	1.72E-08	1.92E-08	2.36E-08	2.35E-08	2.12E-08
1036	1.34E-08	1.58E-08	1.83E-08	2.04E-08	2.49E-08	2.48E-08	2.25E-08
1038	1.39E-08	1.63E-08	1.90E-08	2.12E-08	2.59E-08	2.58E-08	2.34E-08
1039	1.21E-08	1.21E-08	1.21E-08	1.21E-08	1.20E-08	1.20E-08	1.20E-08
<b>Biased Statistics</b>							
Average Biased	1.33E-08	1.60E-08	1.97E-08	2.30E-08	3.01E-08	3.02E-08	2.78E-08
Std Dev Biased	4.39E-10	4.79E-10	5.72E-10	7.96E-10	9.43E-10	9.48E-10	9.84E-10
Ps99%/90% (+KTL) Biased	1.53E-08	1.82E-08	2.24E-08	2.67E-08	3.45E-08	3.46E-08	3.24E-08
Ps99%/90% (-KTL) Biased	1.12E-08	1.37E-08	1.71E-08	1.93E-08	2.57E-08	2.58E-08	2.32E-08
<b>Un-Biased Statistics</b>							
Average Un-Biased	1.34E-08	1.57E-08	1.82E-08	2.03E-08	2.48E-08	2.47E-08	2.24E-08
Std Dev Un-Biased	4.96E-10	5.56E-10	6.59E-10	7.04E-10	8.42E-10	8.36E-10	8.19E-10
Ps99%/90% (+KTL) Un-Biased	1.57E-08	1.83E-08	2.13E-08	2.36E-08	2.87E-08	2.86E-08	2.62E-08
Ps99%/90% (-KTL) Un-Biased	1.10E-08	1.31E-08	1.51E-08	1.70E-08	2.09E-08	2.08E-08	1.85E-08
<b>Specification MIN</b>	<b>-5.00E-08</b>	<b>-8.00E-08</b>	<b>-1.00E-07</b>	<b>-1.00E-07</b>	<b>-1.25E-07</b>	<b>-1.25E-07</b>	<b>-1.25E-07</b>
Status	PASS	PASS	PASS	PASS	PASS	PASS	PASS
<b>Specification MAX</b>	<b>5.00E-08</b>	<b>8.00E-08</b>	<b>1.00E-07</b>	<b>1.00E-07</b>	<b>1.25E-07</b>	<b>1.25E-07</b>	<b>1.25E-07</b>
Status	PASS	PASS	PASS	PASS	PASS	PASS	PASS

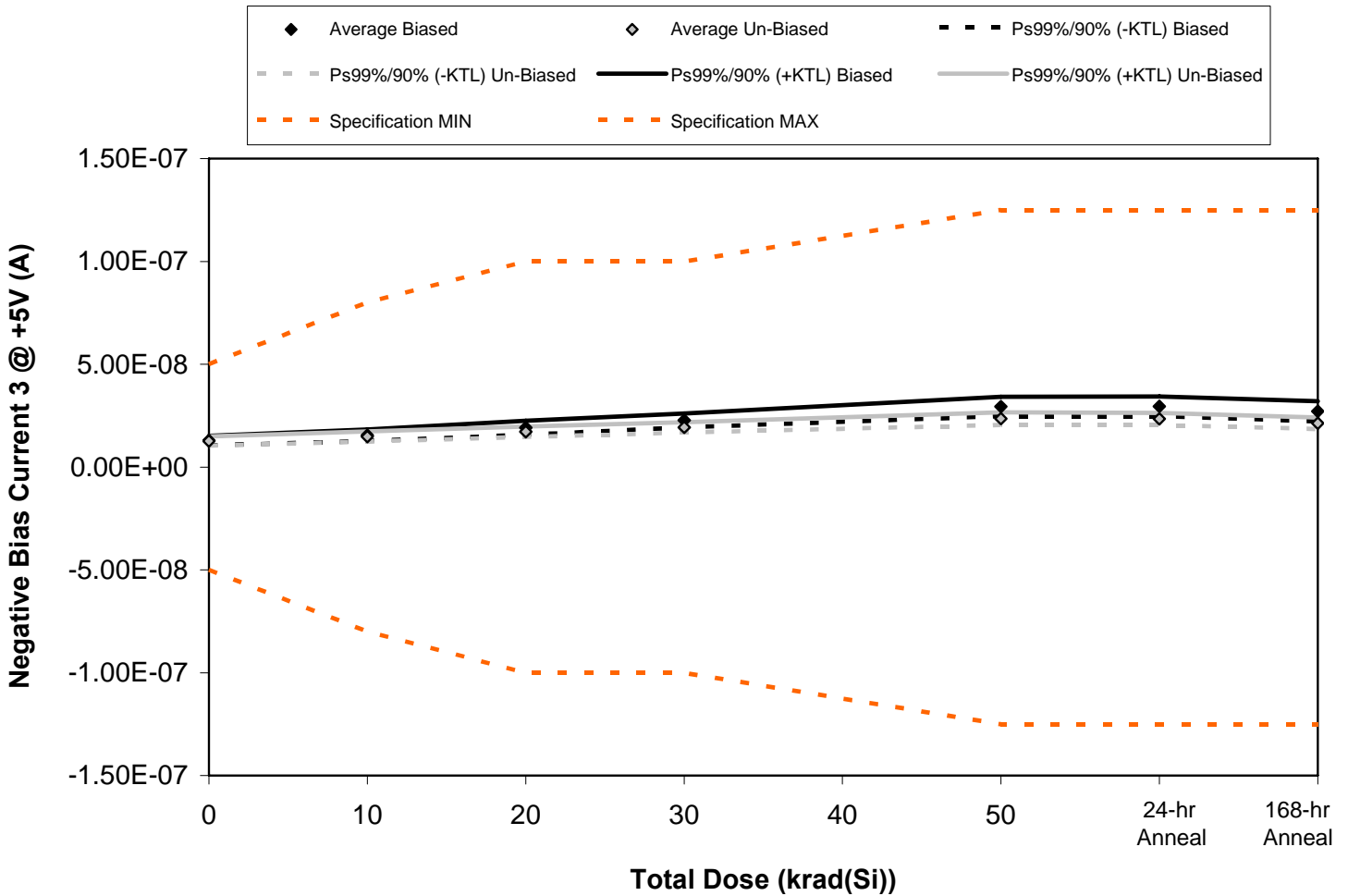

Figure 5.63. Plot of Negative Bias Current 3 @ +/-5V (A) versus total dose. The data show no significant degradation with radiation. The solid diamonds are the average of measured data points from the biased sample (devices irradiated with an electrical bias) while the shaded diamonds are the average from the unbiased sample. The black lines show the effects on the data after application of the biased KTL statistics (solid and dashed lines) while the gray lines show the effects on the data after application of the unbiased KTL statistics (solid and dashed lines). The red dashed lines are the minimum and maximum specification values as defined in the datasheet and/or test plan.



Table 5.63. Raw data for Negative Bias Current 3 @ +/-5V (A) versus total dose, including the statistical analysis, the specification and the status of the testing (pass/fail).

Negative Bias Current 3 @ +5V (A)	Total Dose (krad(Si))					24-hr Anneal	168-hr Anneal
	0	10	20	30	50		
Device							
1027	1.22E-08	1.46E-08	1.83E-08	2.15E-08	2.81E-08	2.82E-08	2.55E-08
1029	1.31E-08	1.56E-08	1.92E-08	2.26E-08	2.94E-08	2.95E-08	2.74E-08
1030	1.26E-08	1.52E-08	1.85E-08	2.29E-08	2.89E-08	2.91E-08	2.69E-08
1031	1.34E-08	1.61E-08	1.98E-08	2.33E-08	3.04E-08	3.05E-08	2.80E-08
1032	1.32E-08	1.59E-08	1.98E-08	2.33E-08	3.05E-08	3.06E-08	2.81E-08
1033	1.32E-08	1.53E-08	1.76E-08	1.97E-08	2.39E-08	2.37E-08	2.17E-08
1034	1.25E-08	1.46E-08	1.71E-08	1.91E-08	2.34E-08	2.32E-08	2.12E-08
1035	1.20E-08	1.41E-08	1.64E-08	1.85E-08	2.26E-08	2.24E-08	2.03E-08
1036	1.30E-08	1.54E-08	1.78E-08	1.98E-08	2.43E-08	2.41E-08	2.17E-08
1038	1.27E-08	1.49E-08	1.73E-08	1.95E-08	2.39E-08	2.37E-08	2.16E-08
1039	1.16E-08	1.16E-08	1.16E-08	1.16E-08	1.15E-08	1.16E-08	1.16E-08
<b>Biased Statistics</b>							
Average Biased	1.29E-08	1.55E-08	1.91E-08	2.27E-08	2.95E-08	2.96E-08	2.72E-08
Std Dev Biased	4.89E-10	5.88E-10	7.15E-10	7.39E-10	1.01E-09	1.02E-09	1.04E-09
Ps99%/90% (+KTL) Biased	1.52E-08	1.82E-08	2.25E-08	2.62E-08	3.42E-08	3.43E-08	3.20E-08
Ps99%/90% (-KTL) Biased	1.06E-08	1.27E-08	1.58E-08	1.93E-08	2.47E-08	2.48E-08	2.23E-08
<b>Un-Biased Statistics</b>							
Average Un-Biased	1.27E-08	1.49E-08	1.73E-08	1.93E-08	2.36E-08	2.34E-08	2.13E-08
Std Dev Un-Biased	4.82E-10	5.18E-10	5.43E-10	5.52E-10	6.52E-10	6.38E-10	5.92E-10
Ps99%/90% (+KTL) Un-Biased	1.49E-08	1.73E-08	1.98E-08	2.19E-08	2.67E-08	2.64E-08	2.41E-08
Ps99%/90% (-KTL) Un-Biased	1.04E-08	1.24E-08	1.47E-08	1.67E-08	2.06E-08	2.05E-08	1.86E-08
<b>Specification MIN</b>	<b>-5.00E-08</b>	<b>-8.00E-08</b>	<b>-1.00E-07</b>	<b>-1.00E-07</b>	<b>-1.25E-07</b>	<b>-1.25E-07</b>	<b>-1.25E-07</b>
Status	PASS	PASS	PASS	PASS	PASS	PASS	PASS
<b>Specification MAX</b>	<b>5.00E-08</b>	<b>8.00E-08</b>	<b>1.00E-07</b>	<b>1.00E-07</b>	<b>1.25E-07</b>	<b>1.25E-07</b>	<b>1.25E-07</b>
Status	PASS	PASS	PASS	PASS	PASS	PASS	PASS

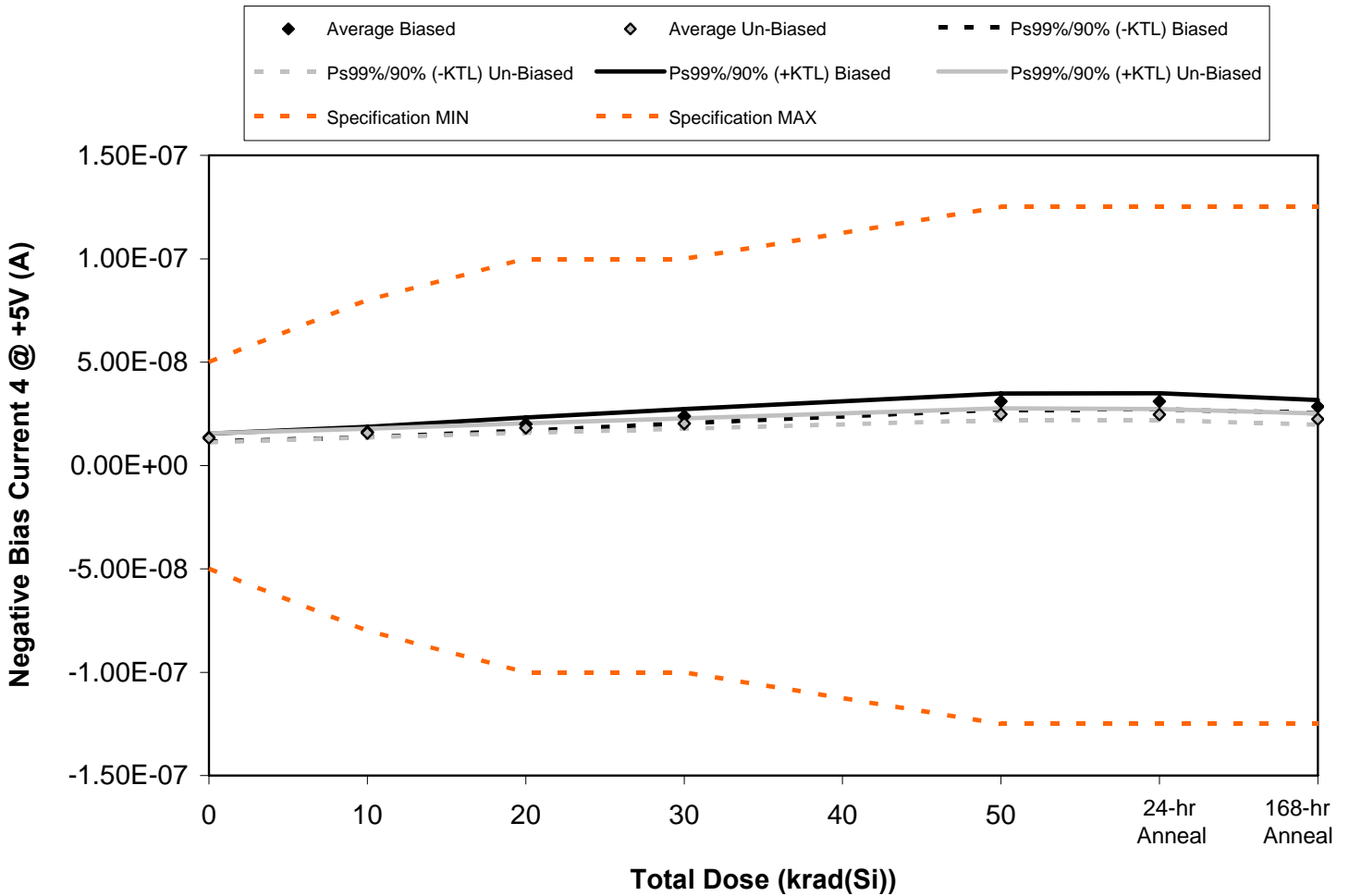

Figure 5.64. Plot of Negative Bias Current 4 @ +/-5V (A) versus total dose. The data show no significant degradation with radiation. The solid diamonds are the average of measured data points from the biased sample (devices irradiated with an electrical bias) while the shaded diamonds are the average from the unbiased sample. The black lines show the effects on the data after application of the biased KTL statistics (solid and dashed lines) while the gray lines show the effects on the data after application of the unbiased KTL statistics (solid and dashed lines). The red dashed lines are the minimum and maximum specification values as defined in the datasheet and/or test plan.



Table 5.64. Raw data for Negative Bias Current 4 @ +/-5V (A) versus total dose, including the statistical analysis, the specification and the status of the testing (pass/fail).

Negative Bias Current 4 @ +5V (A)	Total Dose (krad(Si))					24-hr Anneal	168-hr Anneal
	0	10	20	30	50		
Device							
1027	1.36E-08	1.68E-08	2.07E-08	2.42E-08	3.19E-08	3.19E-08	2.86E-08
1029	1.31E-08	1.57E-08	1.94E-08	2.29E-08	2.98E-08	2.99E-08	2.77E-08
1030	1.33E-08	1.58E-08	1.95E-08	2.46E-08	3.08E-08	3.10E-08	2.86E-08
1031	1.33E-08	1.61E-08	1.98E-08	2.33E-08	3.04E-08	3.05E-08	2.79E-08
1032	1.41E-08	1.68E-08	2.08E-08	2.42E-08	3.16E-08	3.17E-08	2.95E-08
1033	1.32E-08	1.55E-08	1.79E-08	2.01E-08	2.47E-08	2.44E-08	2.23E-08
1034	1.28E-08	1.51E-08	1.75E-08	1.97E-08	2.42E-08	2.39E-08	2.17E-08
1035	1.34E-08	1.57E-08	1.82E-08	2.04E-08	2.48E-08	2.46E-08	2.26E-08
1036	1.40E-08	1.63E-08	1.89E-08	2.11E-08	2.58E-08	2.55E-08	2.33E-08
1038	1.32E-08	1.54E-08	1.80E-08	2.01E-08	2.45E-08	2.44E-08	2.23E-08
1039	1.23E-08	1.24E-08	1.24E-08	1.24E-08	1.23E-08	1.24E-08	1.24E-08
<b>Biased Statistics</b>							
Average Biased	1.35E-08	1.62E-08	2.00E-08	2.39E-08	3.09E-08	3.10E-08	2.85E-08
Std Dev Biased	4.10E-10	5.40E-10	6.74E-10	7.26E-10	8.37E-10	8.35E-10	6.75E-10
Ps99%/90% (+KTL) Biased	1.54E-08	1.88E-08	2.32E-08	2.72E-08	3.48E-08	3.49E-08	3.16E-08
Ps99%/90% (-KTL) Biased	1.16E-08	1.37E-08	1.69E-08	2.05E-08	2.70E-08	2.71E-08	2.53E-08
<b>Un-Biased Statistics</b>							
Average Un-Biased	1.33E-08	1.56E-08	1.81E-08	2.03E-08	2.48E-08	2.46E-08	2.24E-08
Std Dev Un-Biased	4.65E-10	4.54E-10	5.00E-10	5.30E-10	6.10E-10	5.89E-10	5.82E-10
Ps99%/90% (+KTL) Un-Biased	1.55E-08	1.77E-08	2.04E-08	2.28E-08	2.76E-08	2.73E-08	2.52E-08
Ps99%/90% (-KTL) Un-Biased	1.11E-08	1.35E-08	1.58E-08	1.78E-08	2.19E-08	2.18E-08	1.97E-08
<b>Specification MIN</b>	<b>-5.00E-08</b>	<b>-8.00E-08</b>	<b>-1.00E-07</b>	<b>-1.00E-07</b>	<b>-1.25E-07</b>	<b>-1.25E-07</b>	<b>-1.25E-07</b>
Status	PASS	PASS	PASS	PASS	PASS	PASS	PASS
<b>Specification MAX</b>	<b>5.00E-08</b>	<b>8.00E-08</b>	<b>1.00E-07</b>	<b>1.00E-07</b>	<b>1.25E-07</b>	<b>1.25E-07</b>	<b>1.25E-07</b>
Status	PASS	PASS	PASS	PASS	PASS	PASS	PASS

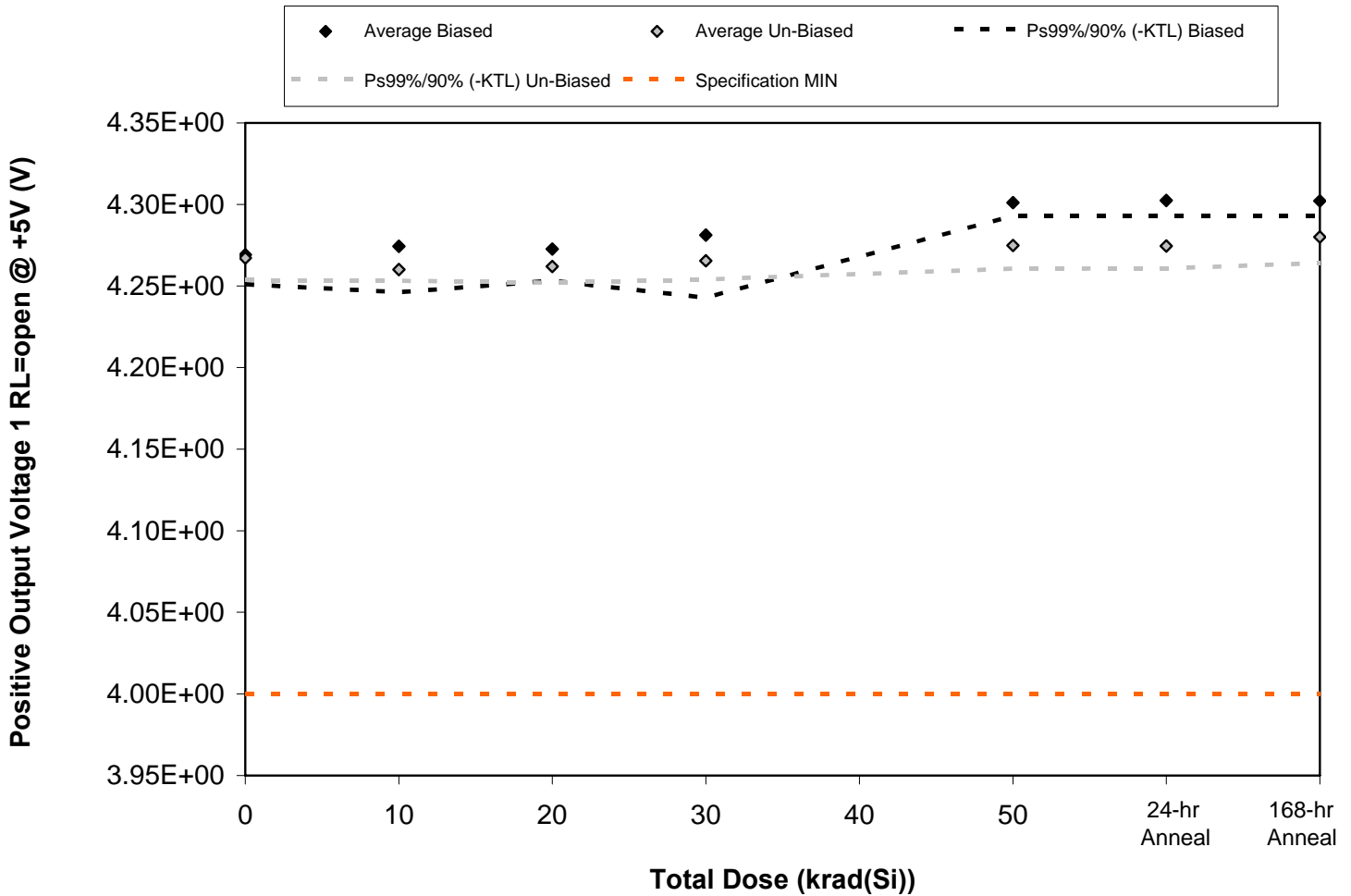

Figure 5.65. Plot of Positive Output Voltage 1 RL=open @ +5V (V) versus total dose. The data show no significant degradation with radiation. The solid diamonds are the average of measured data points from the biased sample (devices irradiated with an electrical bias) while the shaded diamonds are the average from the unbiased sample. The black lines show the effects on the data after application of the biased KTL statistics (solid and dashed lines) while the gray lines show the effects on the data after application of the unbiased KTL statistics (solid and dashed lines). The red dashed lines are the minimum and maximum specification values as defined in the datasheet and/or test plan.





Table 5.65. Raw data for Positive Output Voltage 1 RL=open @ +5V (V) versus total dose, including the statistical analysis, the specification and the status of the testing (pass/fail).

Positive Output Voltage 1 RL=open @ +5V (V)	Total Dose (krad(Si))					24-hr Anneal	168-hr Anneal
	0	10	20	30	50		
Device							
1027	4.27E+00	4.27E+00	4.27E+00	4.28E+00	4.30E+00	4.31E+00	4.31E+00
1029	4.27E+00	4.28E+00	4.28E+00	4.28E+00	4.30E+00	4.30E+00	4.30E+00
1030	4.27E+00	4.28E+00	4.28E+00	4.29E+00	4.30E+00	4.30E+00	4.30E+00
1031	4.27E+00	4.28E+00	4.27E+00	4.28E+00	4.30E+00	4.30E+00	4.30E+00
1032	4.27E+00	4.27E+00	4.27E+00	4.27E+00	4.30E+00	4.30E+00	4.30E+00
1033	4.27E+00	4.26E+00	4.26E+00	4.27E+00	4.28E+00	4.28E+00	4.29E+00
1034	4.27E+00	4.26E+00	4.26E+00	4.27E+00	4.28E+00	4.28E+00	4.28E+00
1035	4.26E+00	4.26E+00	4.26E+00	4.26E+00	4.27E+00	4.27E+00	4.28E+00
1036	4.27E+00	4.26E+00	4.26E+00	4.27E+00	4.28E+00	4.28E+00	4.28E+00
1038	4.27E+00	4.26E+00	4.26E+00	4.26E+00	4.27E+00	4.27E+00	4.28E+00
1039	4.27E+00	4.28E+00	4.27E+00	4.27E+00	4.27E+00	4.27E+00	4.27E+00
<b>Biased Statistics</b>							
Average Biased	4.27E+00	4.27E+00	4.27E+00	4.28E+00	4.30E+00	4.30E+00	4.30E+00
Std Dev Biased	3.90E-03	6.02E-03	4.16E-03	8.23E-03	1.79E-03	2.07E-03	1.92E-03
Ps99%/90% (+KTL) Biased	4.29E+00	4.30E+00	4.29E+00	4.32E+00	4.31E+00	4.31E+00	4.31E+00
Ps99%/90% (-KTL) Biased	4.25E+00	4.25E+00	4.25E+00	4.24E+00	4.29E+00	4.29E+00	4.29E+00
<b>Un-Biased Statistics</b>							
Average Un-Biased	4.27E+00	4.26E+00	4.26E+00	4.27E+00	4.27E+00	4.27E+00	4.28E+00
Std Dev Un-Biased	2.86E-03	1.48E-03	2.12E-03	2.41E-03	3.03E-03	2.97E-03	3.39E-03
Ps99%/90% (+KTL) Un-Biased	4.28E+00	4.27E+00	4.27E+00	4.28E+00	4.29E+00	4.29E+00	4.30E+00
Ps99%/90% (-KTL) Un-Biased	4.25E+00	4.25E+00	4.25E+00	4.25E+00	4.26E+00	4.26E+00	4.26E+00
<b>Specification MIN</b>	<b>4.00E+00</b>	<b>4.00E+00</b>	<b>4.00E+00</b>	<b>4.00E+00</b>	<b>4.00E+00</b>	<b>4.00E+00</b>	<b>4.00E+00</b>
Status	PASS	PASS	PASS	PASS	PASS	PASS	PASS

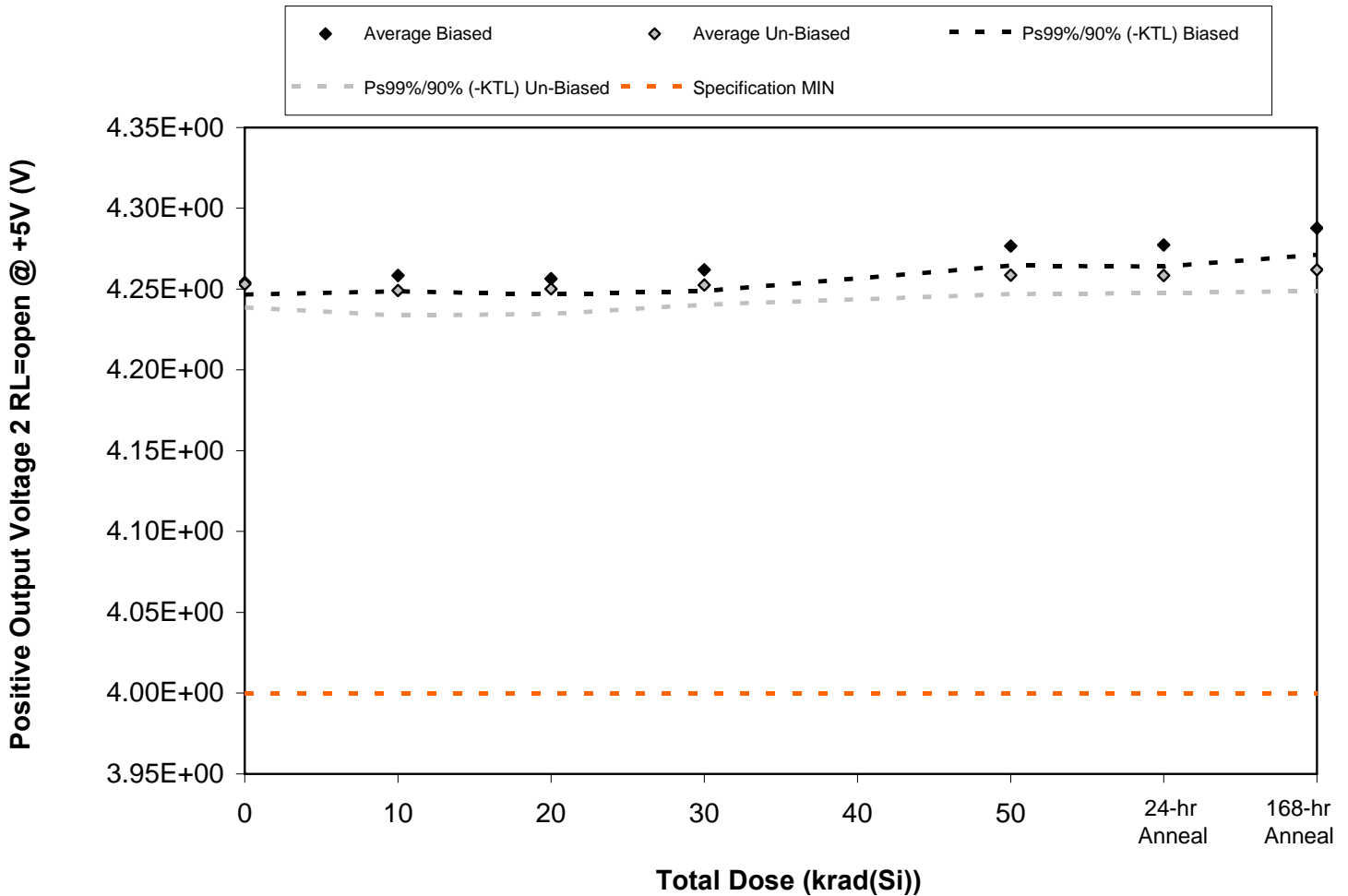

Figure 5.66. Plot of Positive Output Voltage 2 RL=open @ +5V (V) versus total dose. The data show no significant degradation with radiation. The solid diamonds are the average of measured data points from the biased sample (devices irradiated with an electrical bias) while the shaded diamonds are the average from the unbiased sample. The black lines show the effects on the data after application of the biased KTL statistics (solid and dashed lines) while the gray lines show the effects on the data after application of the unbiased KTL statistics (solid and dashed lines). The red dashed lines are the minimum and maximum specification values as defined in the datasheet and/or test plan.



Table 5.66. Raw data for Positive Output Voltage 2 RL=open @ +5V (V) versus total dose, including the statistical analysis, the specification and the status of the testing (pass/fail).

Positive Output Voltage 2 RL=open @ +5V (V)	Total Dose (krad(Si))					24-hr Anneal	168-hr Anneal
	0	10	20	30	50		
Device							
1027	4.26E+00	4.26E+00	4.26E+00	4.26E+00	4.28E+00	4.28E+00	4.29E+00
1029	4.26E+00	4.26E+00	4.26E+00	4.26E+00	4.28E+00	4.28E+00	4.29E+00
1030	4.25E+00	4.26E+00	4.26E+00	4.27E+00	4.28E+00	4.28E+00	4.29E+00
1031	4.25E+00	4.26E+00	4.25E+00	4.26E+00	4.27E+00	4.28E+00	4.29E+00
1032	4.25E+00	4.26E+00	4.26E+00	4.26E+00	4.27E+00	4.27E+00	4.28E+00
1033	4.25E+00	4.25E+00	4.25E+00	4.25E+00	4.26E+00	4.26E+00	4.26E+00
1034	4.26E+00	4.25E+00	4.25E+00	4.26E+00	4.26E+00	4.26E+00	4.26E+00
1035	4.26E+00	4.25E+00	4.25E+00	4.26E+00	4.26E+00	4.26E+00	4.26E+00
1036	4.25E+00	4.25E+00	4.25E+00	4.25E+00	4.26E+00	4.26E+00	4.26E+00
1038	4.25E+00	4.25E+00	4.25E+00	4.25E+00	4.26E+00	4.26E+00	4.26E+00
1039	4.26E+00	4.26E+00	4.26E+00	4.26E+00	4.26E+00	4.26E+00	4.26E+00
<b>Biased Statistics</b>							
Average Biased	4.25E+00	4.26E+00	4.26E+00	4.26E+00	4.28E+00	4.28E+00	4.29E+00
Std Dev Biased	1.58E-03	2.07E-03	2.07E-03	2.83E-03	2.61E-03	2.88E-03	3.56E-03
Ps99%/90% (+KTL) Biased	4.26E+00	4.27E+00	4.27E+00	4.28E+00	4.29E+00	4.29E+00	4.30E+00
Ps99%/90% (-KTL) Biased	4.25E+00	4.25E+00	4.25E+00	4.25E+00	4.26E+00	4.26E+00	4.27E+00
<b>Un-Biased Statistics</b>							
Average Un-Biased	4.25E+00	4.25E+00	4.25E+00	4.25E+00	4.26E+00	4.26E+00	4.26E+00
Std Dev Un-Biased	3.08E-03	3.35E-03	3.35E-03	2.61E-03	2.51E-03	2.30E-03	2.83E-03
Ps99%/90% (+KTL) Un-Biased	4.27E+00	4.26E+00	4.27E+00	4.26E+00	4.27E+00	4.27E+00	4.28E+00
Ps99%/90% (-KTL) Un-Biased	4.24E+00	4.23E+00	4.23E+00	4.24E+00	4.25E+00	4.25E+00	4.25E+00
<b>Specification MIN</b>	<b>4.00E+00</b>	<b>4.00E+00</b>	<b>4.00E+00</b>	<b>4.00E+00</b>	<b>4.00E+00</b>	<b>4.00E+00</b>	<b>4.00E+00</b>
Status	PASS	PASS	PASS	PASS	PASS	PASS	PASS

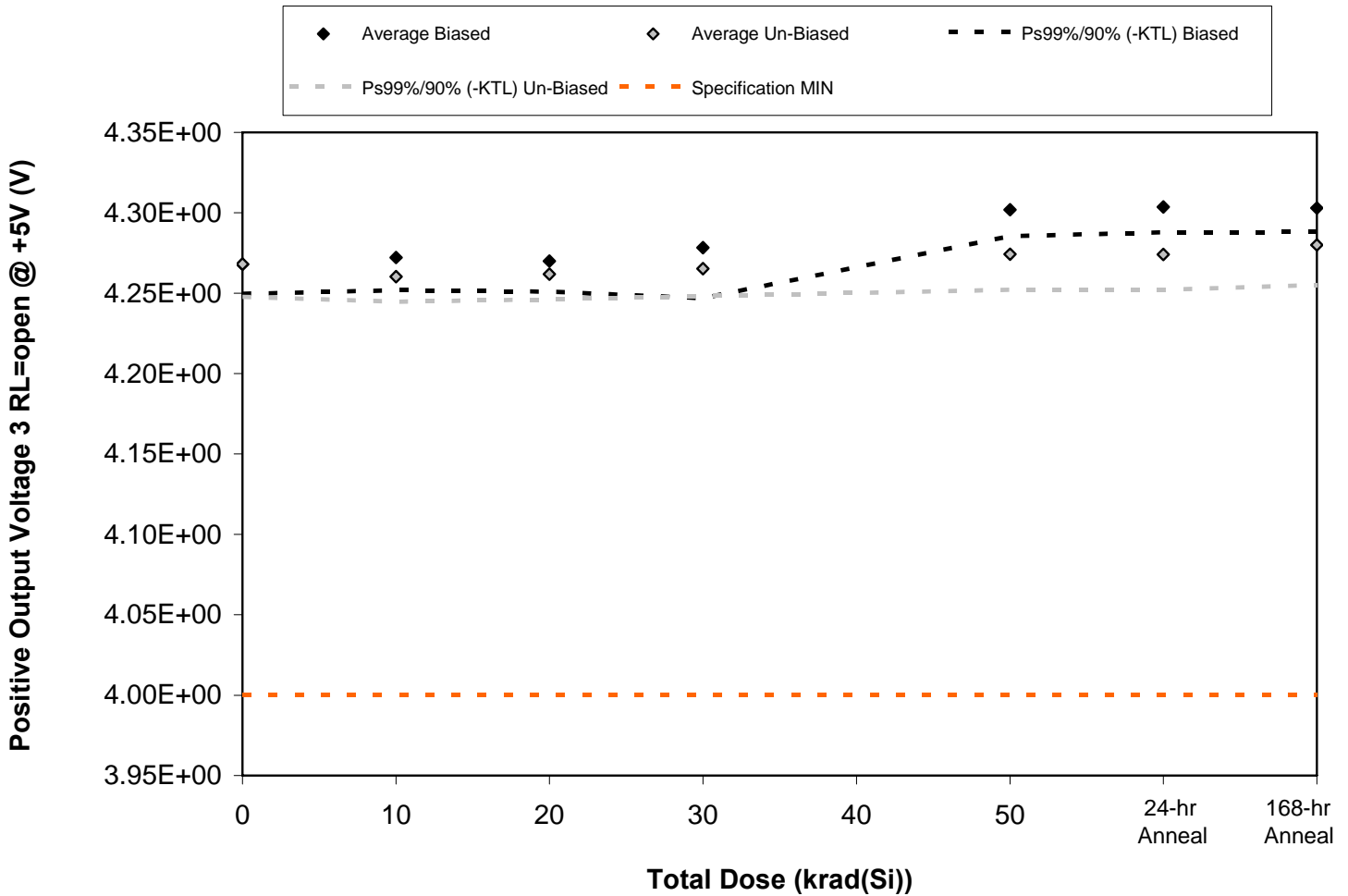

Figure 5.67. Plot of Positive Output Voltage 3 RL=open @ +5V (V) versus total dose. The data show no significant degradation with radiation. The solid diamonds are the average of measured data points from the biased sample (devices irradiated with an electrical bias) while the shaded diamonds are the average from the unbiased sample. The black lines show the effects on the data after application of the biased KTL statistics (solid and dashed lines) while the gray lines show the effects on the data after application of the unbiased KTL statistics (solid and dashed lines). The red dashed lines are the minimum and maximum specification values as defined in the datasheet and/or test plan.



Table 5.67. Raw data for Positive Output Voltage 3 RL=open @ +5V (V) versus total dose, including the statistical analysis, the specification and the status of the testing (pass/fail).

Positive Output Voltage 3 RL=open @ +5V (V)	Total Dose (krad(Si))					24-hr Anneal	168-hr Anneal
	0	10	20	30	50		
Device							
1027	4.27E+00	4.28E+00	4.27E+00	4.28E+00	4.30E+00	4.30E+00	4.30E+00
1029	4.27E+00	4.27E+00	4.27E+00	4.28E+00	4.30E+00	4.30E+00	4.30E+00
1030	4.27E+00	4.28E+00	4.28E+00	4.29E+00	4.31E+00	4.31E+00	4.31E+00
1031	4.27E+00	4.27E+00	4.27E+00	4.27E+00	4.30E+00	4.30E+00	4.30E+00
1032	4.26E+00	4.27E+00	4.27E+00	4.27E+00	4.30E+00	4.30E+00	4.30E+00
1033	4.27E+00	4.26E+00	4.26E+00	4.26E+00	4.28E+00	4.27E+00	4.28E+00
1034	4.26E+00	4.26E+00	4.26E+00	4.26E+00	4.27E+00	4.27E+00	4.27E+00
1035	4.28E+00	4.27E+00	4.27E+00	4.27E+00	4.28E+00	4.28E+00	4.29E+00
1036	4.27E+00	4.26E+00	4.26E+00	4.27E+00	4.28E+00	4.28E+00	4.28E+00
1038	4.27E+00	4.26E+00	4.26E+00	4.27E+00	4.28E+00	4.28E+00	4.28E+00
1039	4.27E+00	4.27E+00	4.27E+00	4.27E+00	4.27E+00	4.27E+00	4.27E+00
<b>Biased Statistics</b>							
Average Biased	4.27E+00	4.27E+00	4.27E+00	4.28E+00	4.30E+00	4.30E+00	4.30E+00
Std Dev Biased	3.94E-03	4.38E-03	4.06E-03	6.77E-03	3.54E-03	3.36E-03	3.16E-03
Ps99%/90% (+KTL) Biased	4.29E+00	4.29E+00	4.29E+00	4.31E+00	4.32E+00	4.32E+00	4.32E+00
Ps99%/90% (-KTL) Biased	4.25E+00	4.25E+00	4.25E+00	4.25E+00	4.29E+00	4.29E+00	4.29E+00
<b>Un-Biased Statistics</b>							
Average Un-Biased	4.27E+00	4.26E+00	4.26E+00	4.27E+00	4.27E+00	4.27E+00	4.28E+00
Std Dev Un-Biased	4.38E-03	3.36E-03	3.35E-03	3.63E-03	4.71E-03	4.69E-03	5.34E-03
Ps99%/90% (+KTL) Un-Biased	4.29E+00	4.28E+00	4.28E+00	4.28E+00	4.30E+00	4.30E+00	4.30E+00
Ps99%/90% (-KTL) Un-Biased	4.25E+00	4.24E+00	4.25E+00	4.25E+00	4.25E+00	4.25E+00	4.26E+00
<b>Specification MIN</b>	<b>4.00E+00</b>	<b>4.00E+00</b>	<b>4.00E+00</b>	<b>4.00E+00</b>	<b>4.00E+00</b>	<b>4.00E+00</b>	<b>4.00E+00</b>
Status	PASS	PASS	PASS	PASS	PASS	PASS	PASS

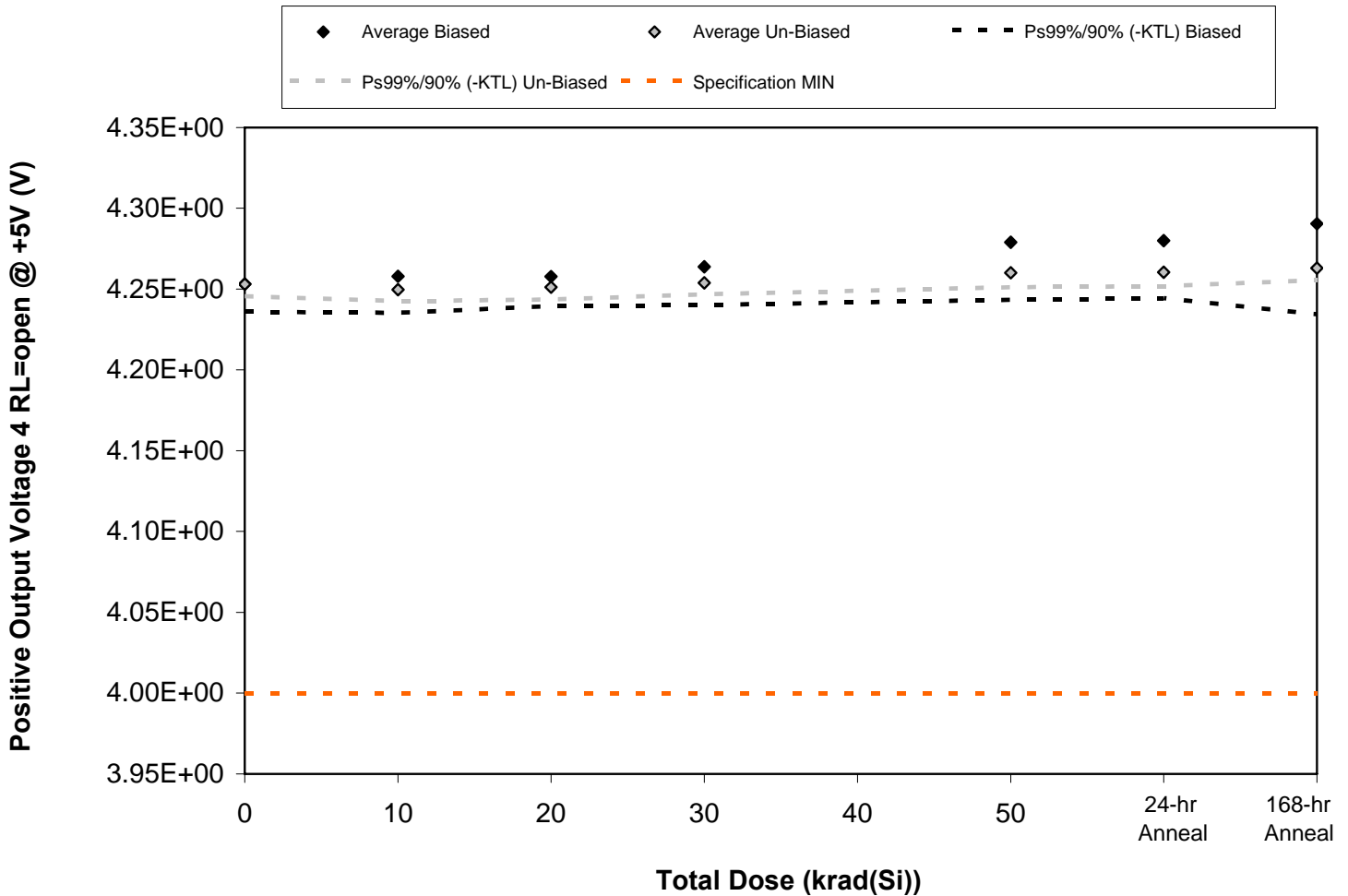

Figure 5.68. Plot of Positive Output Voltage 4 RL=open @ +5V (V) versus total dose. The data show no significant degradation with radiation. The solid diamonds are the average of measured data points from the biased sample (devices irradiated with an electrical bias) while the shaded diamonds are the average from the unbiased sample. The black lines show the effects on the data after application of the biased KTL statistics (solid and dashed lines) while the gray lines show the effects on the data after application of the unbiased KTL statistics (solid and dashed lines). The red dashed lines are the minimum and maximum specification values as defined in the datasheet and/or test plan.



Table 5.68. Raw data for Positive Output Voltage 4 RL=open @ +5V (V) versus total dose, including the statistical analysis, the specification and the status of the testing (pass/fail).

Positive Output Voltage 4 RL=open @ +5V (V)	Total Dose (krad(Si))					24-hr Anneal	168-hr Anneal
	0	10	20	30	50		
Device							
1027	4.25E+00	4.25E+00	4.26E+00	4.26E+00	4.27E+00	4.27E+00	4.28E+00
1029	4.26E+00	4.26E+00	4.26E+00	4.27E+00	4.29E+00	4.29E+00	4.30E+00
1030	4.25E+00	4.26E+00	4.26E+00	4.27E+00	4.29E+00	4.29E+00	4.30E+00
1031	4.26E+00	4.26E+00	4.26E+00	4.26E+00	4.28E+00	4.28E+00	4.29E+00
1032	4.25E+00	4.26E+00	4.25E+00	4.26E+00	4.27E+00	4.27E+00	4.28E+00
1033	4.25E+00	4.25E+00	4.25E+00	4.25E+00	4.26E+00	4.26E+00	4.26E+00
1034	4.26E+00	4.25E+00	4.25E+00	4.26E+00	4.26E+00	4.26E+00	4.27E+00
1035	4.25E+00	4.25E+00	4.25E+00	4.25E+00	4.26E+00	4.26E+00	4.26E+00
1036	4.25E+00	4.25E+00	4.25E+00	4.25E+00	4.26E+00	4.26E+00	4.26E+00
1038	4.25E+00	4.25E+00	4.25E+00	4.25E+00	4.26E+00	4.26E+00	4.26E+00
1039	4.26E+00	4.26E+00	4.26E+00	4.26E+00	4.26E+00	4.26E+00	4.26E+00
<b>Biased Statistics</b>							
Average Biased	4.25E+00	4.26E+00	4.26E+00	4.26E+00	4.28E+00	4.28E+00	4.29E+00
Std Dev Biased	3.70E-03	4.85E-03	3.90E-03	5.07E-03	7.62E-03	7.62E-03	1.20E-02
Ps99%/90% (+KTL) Biased	4.27E+00	4.28E+00	4.28E+00	4.29E+00	4.31E+00	4.32E+00	4.35E+00
Ps99%/90% (-KTL) Biased	4.24E+00	4.24E+00	4.24E+00	4.24E+00	4.24E+00	4.24E+00	4.23E+00
<b>Un-Biased Statistics</b>							
Average Un-Biased	4.25E+00	4.25E+00	4.25E+00	4.25E+00	4.26E+00	4.26E+00	4.26E+00
Std Dev Un-Biased	1.58E-03	1.52E-03	1.64E-03	1.48E-03	1.92E-03	1.82E-03	1.58E-03
Ps99%/90% (+KTL) Un-Biased	4.26E+00	4.26E+00	4.26E+00	4.26E+00	4.27E+00	4.27E+00	4.27E+00
Ps99%/90% (-KTL) Un-Biased	4.25E+00	4.24E+00	4.24E+00	4.25E+00	4.25E+00	4.25E+00	4.26E+00
<b>Specification MIN</b>	<b>4.00E+00</b>	<b>4.00E+00</b>	<b>4.00E+00</b>	<b>4.00E+00</b>	<b>4.00E+00</b>	<b>4.00E+00</b>	<b>4.00E+00</b>
Status	PASS	PASS	PASS	PASS	PASS	PASS	PASS

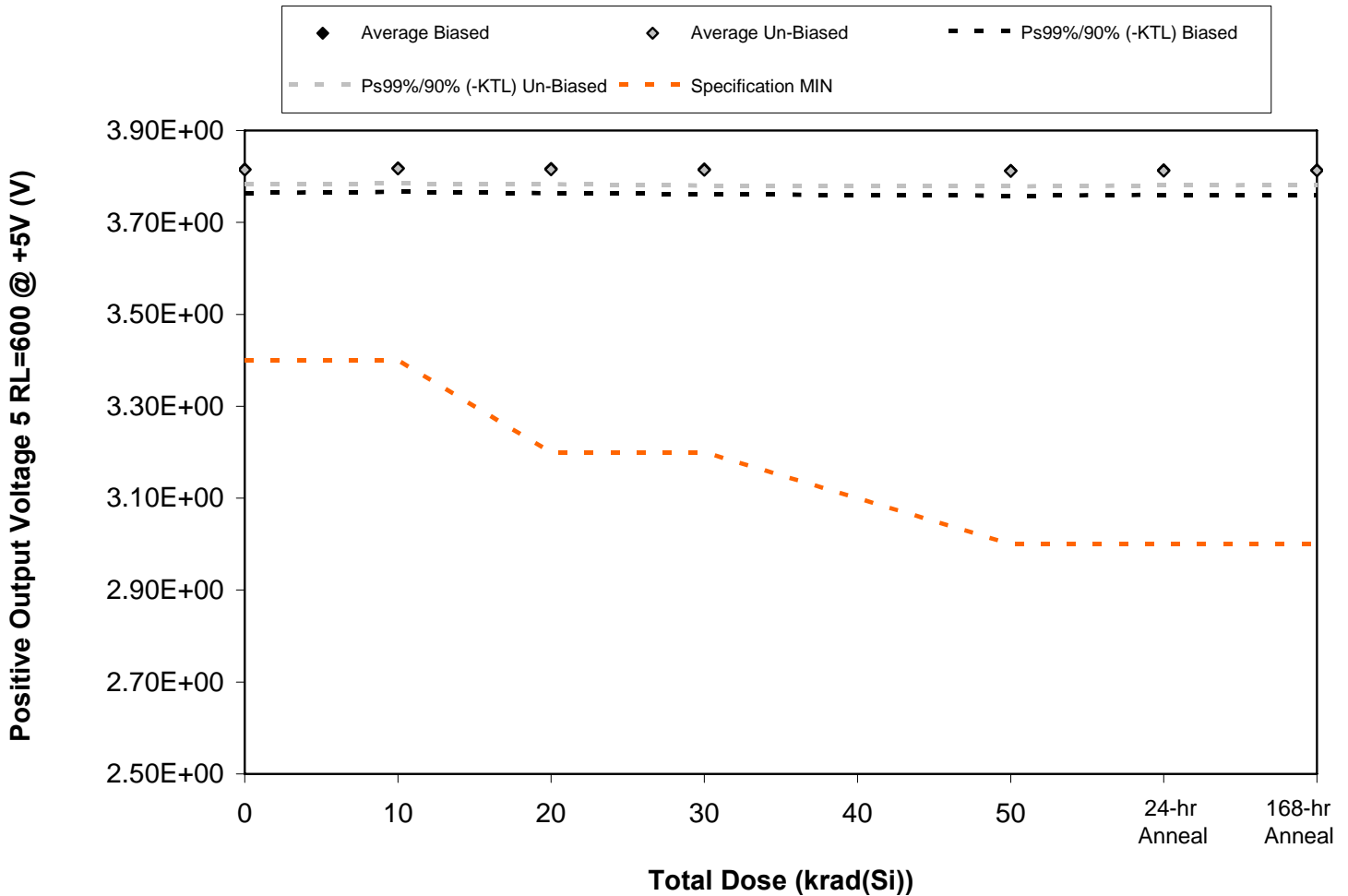

Figure 5.69. Plot of Positive Output Voltage 5 RL=600 @ +5V (V) versus total dose. The data show no significant degradation with radiation. The solid diamonds are the average of measured data points from the biased sample (devices irradiated with an electrical bias) while the shaded diamonds are the average from the unbiased sample. The black lines show the effects on the data after application of the biased KTL statistics (solid and dashed lines) while the gray lines show the effects on the data after application of the unbiased KTL statistics (solid and dashed lines). The red dashed lines are the minimum and maximum specification values as defined in the datasheet and/or test plan.





Table 5.69. Raw data for Positive Output Voltage 5 RL=600 @ +5V (V) versus total dose, including the statistical analysis, the specification and the status of the testing (pass/fail).

Positive Output Voltage 5 RL=600 @ +5V (V)	Total Dose (krad(Si))					24-hr Anneal	168-hr Anneal
	0	10	20	30	50		
Device							
1027	3.83E+00	3.83E+00	3.83E+00	3.83E+00	3.83E+00	3.83E+00	3.83E+00
1029	3.81E+00	3.81E+00	3.81E+00	3.81E+00	3.81E+00	3.81E+00	3.81E+00
1030	3.81E+00	3.81E+00	3.81E+00	3.81E+00	3.80E+00	3.81E+00	3.81E+00
1031	3.82E+00	3.83E+00	3.82E+00	3.82E+00	3.82E+00	3.82E+00	3.82E+00
1032	3.81E+00	3.81E+00	3.81E+00	3.81E+00	3.80E+00	3.80E+00	3.80E+00
1033	3.80E+00	3.81E+00	3.80E+00	3.80E+00	3.80E+00	3.80E+00	3.80E+00
1034	3.82E+00	3.82E+00	3.82E+00	3.82E+00	3.82E+00	3.82E+00	3.82E+00
1035	3.81E+00	3.82E+00	3.81E+00	3.81E+00	3.81E+00	3.81E+00	3.81E+00
1036	3.82E+00	3.82E+00	3.82E+00	3.82E+00	3.82E+00	3.82E+00	3.82E+00
1038	3.82E+00	3.82E+00	3.82E+00	3.82E+00	3.82E+00	3.82E+00	3.82E+00
1039	3.82E+00	3.82E+00	3.82E+00	3.82E+00	3.82E+00	3.82E+00	3.82E+00
<b>Biased Statistics</b>							
Average Biased	3.82E+00	3.82E+00	3.82E+00	3.82E+00	3.81E+00	3.81E+00	3.81E+00
Std Dev Biased	1.11E-02	1.10E-02	1.13E-02	1.16E-02	1.18E-02	1.16E-02	1.18E-02
Ps99%/90% (+KTL) Biased	3.87E+00	3.87E+00	3.87E+00	3.87E+00	3.87E+00	3.87E+00	3.87E+00
Ps99%/90% (-KTL) Biased	3.76E+00	3.77E+00	3.76E+00	3.76E+00	3.76E+00	3.76E+00	3.76E+00
<b>Un-Biased Statistics</b>							
Average Un-Biased	3.81E+00	3.82E+00	3.82E+00	3.81E+00	3.81E+00	3.81E+00	3.81E+00
Std Dev Un-Biased	6.58E-03	6.82E-03	6.88E-03	7.18E-03	7.09E-03	6.76E-03	6.82E-03
Ps99%/90% (+KTL) Un-Biased	3.85E+00	3.85E+00	3.85E+00	3.85E+00	3.84E+00	3.84E+00	3.84E+00
Ps99%/90% (-KTL) Un-Biased	3.78E+00	3.79E+00	3.78E+00	3.78E+00	3.78E+00	3.78E+00	3.78E+00
<b>Specification MIN</b>	<b>3.40E+00</b>	<b>3.40E+00</b>	<b>3.20E+00</b>	<b>3.20E+00</b>	<b>3.00E+00</b>	<b>3.00E+00</b>	<b>3.00E+00</b>
Status	PASS	PASS	PASS	PASS	PASS	PASS	PASS

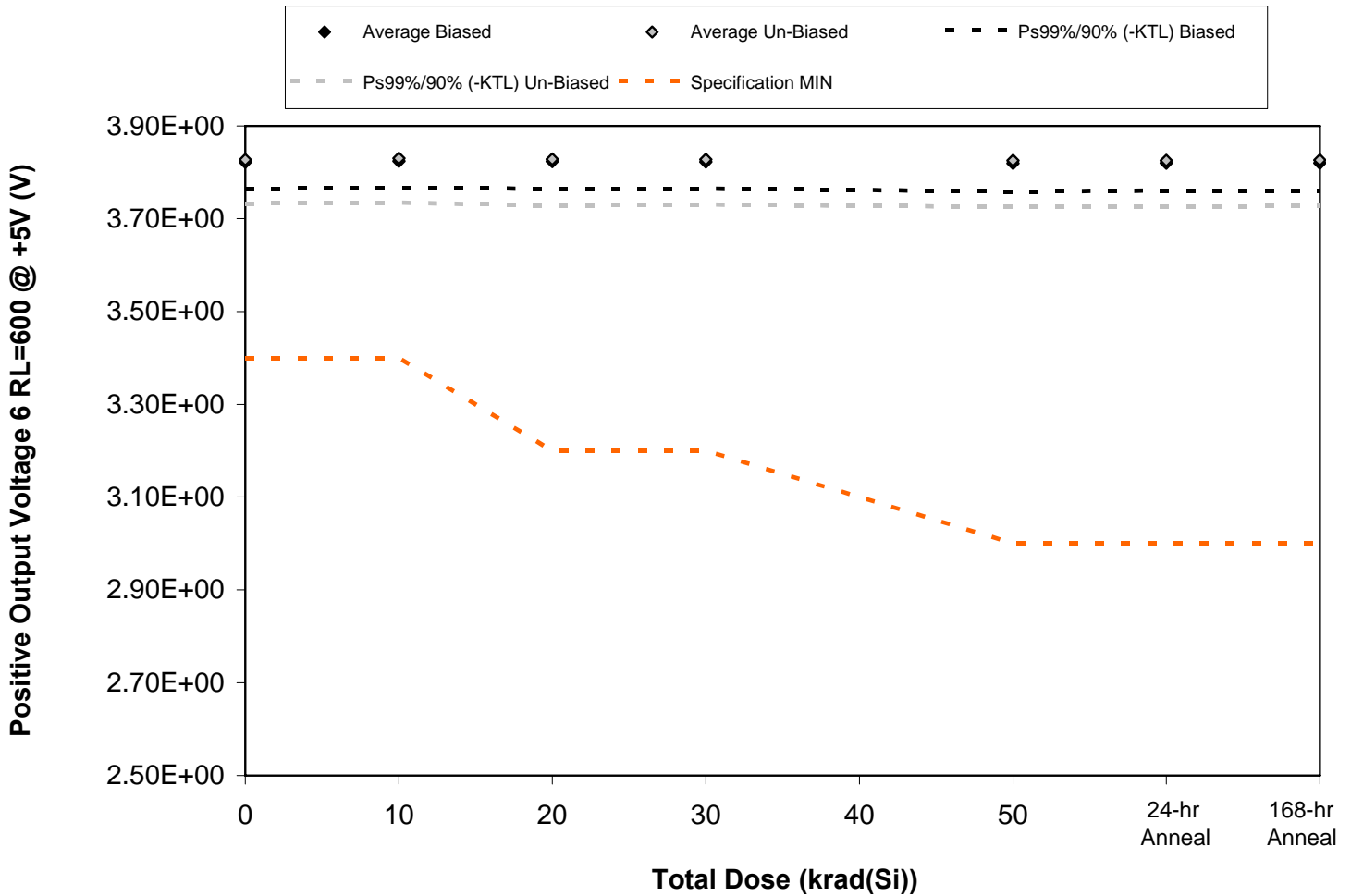

Figure 5.70. Plot of Positive Output Voltage 6 RL=600 @ +5V (V) versus total dose. The data show no significant degradation with radiation. The solid diamonds are the average of measured data points from the biased sample (devices irradiated with an electrical bias) while the shaded diamonds are the average from the unbiased sample. The black lines show the effects on the data after application of the biased KTL statistics (solid and dashed lines) while the gray lines show the effects on the data after application of the unbiased KTL statistics (solid and dashed lines). The red dashed lines are the minimum and maximum specification values as defined in the datasheet and/or test plan.



Table 5.70. Raw data for Positive Output Voltage 6 RL=600 @ +5V (V) versus total dose, including the statistical analysis, the specification and the status of the testing (pass/fail).

Positive Output Voltage 6 RL=600 @ +5V (V)	Total Dose (krad(Si))					24-hr Anneal	168-hr Anneal
	0	10	20	30	50		
Device							
1027	3.82E+00	3.82E+00	3.82E+00	3.82E+00	3.82E+00	3.82E+00	3.82E+00
1029	3.82E+00	3.83E+00	3.82E+00	3.82E+00	3.82E+00	3.82E+00	3.82E+00
1030	3.84E+00	3.84E+00	3.84E+00	3.84E+00	3.84E+00	3.84E+00	3.84E+00
1031	3.81E+00	3.81E+00	3.81E+00	3.81E+00	3.81E+00	3.81E+00	3.81E+00
1032	3.81E+00	3.82E+00	3.82E+00	3.82E+00	3.81E+00	3.81E+00	3.81E+00
1033	3.82E+00	3.82E+00	3.82E+00	3.82E+00	3.81E+00	3.81E+00	3.81E+00
1034	3.85E+00	3.86E+00	3.86E+00	3.86E+00	3.85E+00	3.85E+00	3.85E+00
1035	3.84E+00	3.85E+00	3.85E+00	3.85E+00	3.84E+00	3.84E+00	3.84E+00
1036	3.81E+00	3.81E+00	3.81E+00	3.81E+00	3.81E+00	3.81E+00	3.81E+00
1038	3.81E+00	3.81E+00	3.81E+00	3.81E+00	3.81E+00	3.81E+00	3.81E+00
1039	3.84E+00	3.84E+00	3.84E+00	3.84E+00	3.84E+00	3.84E+00	3.84E+00
<b>Biased Statistics</b>							
Average Biased	3.82E+00	3.82E+00	3.82E+00	3.82E+00	3.82E+00	3.82E+00	3.82E+00
Std Dev Biased	1.23E-02	1.24E-02	1.26E-02	1.24E-02	1.30E-02	1.28E-02	1.28E-02
Ps99%/90% (+KTL) Biased	3.88E+00	3.88E+00	3.88E+00	3.88E+00	3.88E+00	3.88E+00	3.88E+00
Ps99%/90% (-KTL) Biased	3.76E+00	3.77E+00	3.76E+00	3.76E+00	3.76E+00	3.76E+00	3.76E+00
<b>Un-Biased Statistics</b>							
Average Un-Biased	3.83E+00	3.83E+00	3.83E+00	3.83E+00	3.83E+00	3.83E+00	3.83E+00
Std Dev Un-Biased	2.03E-02	2.05E-02	2.15E-02	2.08E-02	2.14E-02	2.15E-02	2.12E-02
Ps99%/90% (+KTL) Un-Biased	3.92E+00	3.93E+00	3.93E+00	3.92E+00	3.92E+00	3.93E+00	3.93E+00
Ps99%/90% (-KTL) Un-Biased	3.73E+00	3.73E+00	3.73E+00	3.73E+00	3.73E+00	3.72E+00	3.73E+00
<b>Specification MIN</b>	<b>3.40E+00</b>	<b>3.40E+00</b>	<b>3.20E+00</b>	<b>3.20E+00</b>	<b>3.00E+00</b>	<b>3.00E+00</b>	<b>3.00E+00</b>
Status	PASS	PASS	PASS	PASS	PASS	PASS	PASS

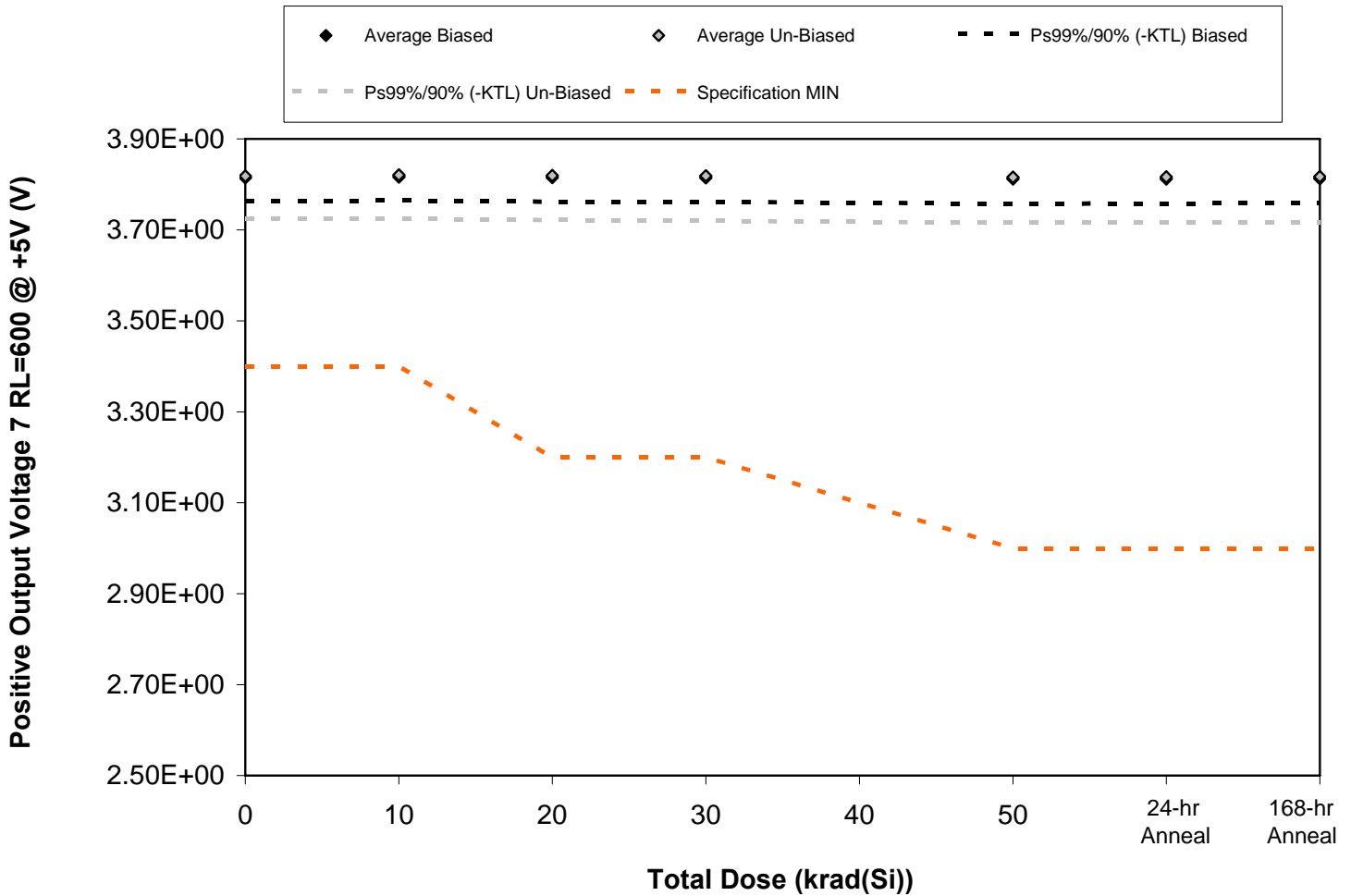

Figure 5.71. Plot of Positive Output Voltage 7 RL=600 @ +5V (V) versus total dose. The data show no significant degradation with radiation. The solid diamonds are the average of measured data points from the biased sample (devices irradiated with an electrical bias) while the shaded diamonds are the average from the unbiased sample. The black lines show the effects on the data after application of the biased KTL statistics (solid and dashed lines) while the gray lines show the effects on the data after application of the unbiased KTL statistics (solid and dashed lines). The red dashed lines are the minimum and maximum specification values as defined in the datasheet and/or test plan.



Table 5.71. Raw data for Positive Output Voltage 7 RL=600 @ +5V (V) versus total dose, including the statistical analysis, the specification and the status of the testing (pass/fail).

Positive Output Voltage 7 RL=600 @ +5V (V)	Total Dose (krad(Si))					24-hr Anneal	168-hr Anneal
	0	10	20	30	50		
Device							
1027	3.81E+00	3.81E+00	3.81E+00	3.81E+00	3.81E+00	3.81E+00	3.81E+00
1029	3.81E+00	3.82E+00	3.82E+00	3.82E+00	3.81E+00	3.81E+00	3.81E+00
1030	3.83E+00	3.84E+00	3.84E+00	3.83E+00	3.83E+00	3.83E+00	3.83E+00
1031	3.80E+00	3.81E+00	3.81E+00	3.80E+00	3.80E+00	3.80E+00	3.80E+00
1032	3.81E+00	3.81E+00	3.81E+00	3.81E+00	3.81E+00	3.81E+00	3.81E+00
1033	3.81E+00	3.81E+00	3.81E+00	3.81E+00	3.80E+00	3.80E+00	3.80E+00
1034	3.85E+00	3.85E+00	3.85E+00	3.85E+00	3.85E+00	3.85E+00	3.85E+00
1035	3.83E+00	3.84E+00	3.84E+00	3.84E+00	3.83E+00	3.83E+00	3.83E+00
1036	3.80E+00	3.81E+00	3.81E+00	3.80E+00	3.80E+00	3.80E+00	3.80E+00
1038	3.80E+00	3.80E+00	3.80E+00	3.80E+00	3.80E+00	3.80E+00	3.80E+00
1039	3.83E+00	3.83E+00	3.83E+00	3.83E+00	3.83E+00	3.83E+00	3.83E+00
<b>Biased Statistics</b>							
Average Biased	3.81E+00	3.82E+00	3.82E+00	3.82E+00	3.81E+00	3.81E+00	3.81E+00
Std Dev Biased	1.10E-02	1.11E-02	1.15E-02	1.14E-02	1.17E-02	1.17E-02	1.14E-02
Ps99%/90% (+KTL) Biased	3.87E+00	3.87E+00	3.87E+00	3.87E+00	3.87E+00	3.87E+00	3.87E+00
Ps99%/90% (-KTL) Biased	3.76E+00	3.76E+00	3.76E+00	3.76E+00	3.76E+00	3.76E+00	3.76E+00
<b>Un-Biased Statistics</b>							
Average Un-Biased	3.82E+00	3.82E+00	3.82E+00	3.82E+00	3.82E+00	3.82E+00	3.82E+00
Std Dev Un-Biased	2.02E-02	2.06E-02	2.10E-02	2.13E-02	2.15E-02	2.16E-02	2.15E-02
Ps99%/90% (+KTL) Un-Biased	3.91E+00	3.92E+00	3.92E+00	3.92E+00	3.92E+00	3.92E+00	3.92E+00
Ps99%/90% (-KTL) Un-Biased	3.72E+00	3.72E+00	3.72E+00	3.72E+00	3.72E+00	3.72E+00	3.72E+00
<b>Specification MIN</b>	<b>3.40E+00</b>	<b>3.40E+00</b>	<b>3.20E+00</b>	<b>3.20E+00</b>	<b>3.00E+00</b>	<b>3.00E+00</b>	<b>3.00E+00</b>
Status	PASS	PASS	PASS	PASS	PASS	PASS	PASS

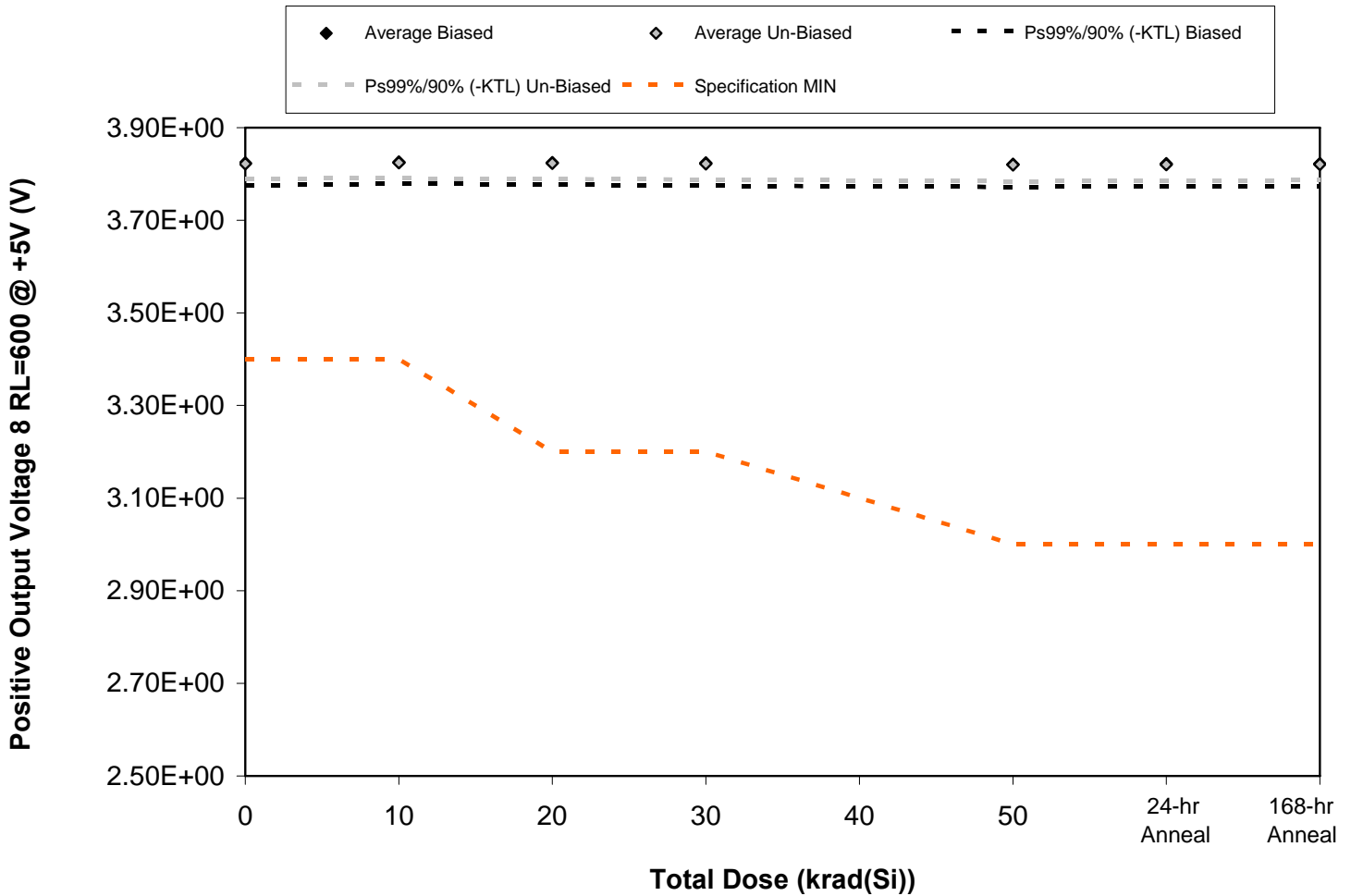

Figure 5.72. Plot of Positive Output Voltage 8 RL=600 @ +5V (V) versus total dose. The data show no significant degradation with radiation. The solid diamonds are the average of measured data points from the biased sample (devices irradiated with an electrical bias) while the shaded diamonds are the average from the unbiased sample. The black lines show the effects on the data after application of the biased KTL statistics (solid and dashed lines) while the gray lines show the effects on the data after application of the unbiased KTL statistics (solid and dashed lines). The red dashed lines are the minimum and maximum specification values as defined in the datasheet and/or test plan.



Table 5.72. Raw data for Positive Output Voltage 8 RL=600 @ +5V (V) versus total dose, including the statistical analysis, the specification and the status of the testing (pass/fail).

Positive Output Voltage 8 RL=600 @ +5V (V)	Total Dose (krad(Si))					24-hr Anneal	168-hr Anneal
	0	10	20	30	50		
Device							
1027	3.84E+00	3.84E+00	3.84E+00	3.84E+00	3.84E+00	3.84E+00	3.84E+00
1029	3.82E+00	3.82E+00	3.82E+00	3.82E+00	3.82E+00	3.82E+00	3.82E+00
1030	3.82E+00	3.82E+00	3.82E+00	3.82E+00	3.81E+00	3.81E+00	3.81E+00
1031	3.83E+00	3.83E+00	3.83E+00	3.83E+00	3.83E+00	3.83E+00	3.83E+00
1032	3.81E+00	3.82E+00	3.82E+00	3.81E+00	3.81E+00	3.81E+00	3.81E+00
1033	3.81E+00	3.81E+00	3.81E+00	3.81E+00	3.81E+00	3.81E+00	3.81E+00
1034	3.83E+00	3.83E+00	3.83E+00	3.83E+00	3.82E+00	3.83E+00	3.83E+00
1035	3.82E+00	3.82E+00	3.82E+00	3.82E+00	3.82E+00	3.82E+00	3.82E+00
1036	3.83E+00	3.83E+00	3.83E+00	3.83E+00	3.82E+00	3.82E+00	3.83E+00
1038	3.83E+00	3.83E+00	3.83E+00	3.83E+00	3.83E+00	3.83E+00	3.83E+00
1039	3.83E+00	3.83E+00	3.83E+00	3.83E+00	3.83E+00	3.83E+00	3.83E+00
<b>Biased Statistics</b>							
Average Biased	3.82E+00	3.83E+00	3.82E+00	3.82E+00	3.82E+00	3.82E+00	3.82E+00
Std Dev Biased	1.04E-02	1.01E-02	1.01E-02	1.06E-02	1.06E-02	1.04E-02	1.04E-02
Ps99%/90% (+KTL) Biased	3.87E+00	3.87E+00	3.87E+00	3.87E+00	3.87E+00	3.87E+00	3.87E+00
Ps99%/90% (-KTL) Biased	3.78E+00	3.78E+00	3.78E+00	3.77E+00	3.77E+00	3.77E+00	3.77E+00
<b>Un-Biased Statistics</b>							
Average Un-Biased	3.82E+00	3.82E+00	3.82E+00	3.82E+00	3.82E+00	3.82E+00	3.82E+00
Std Dev Un-Biased	6.88E-03	7.22E-03	7.29E-03	7.29E-03	7.57E-03	7.44E-03	7.31E-03
Ps99%/90% (+KTL) Un-Biased	3.85E+00	3.86E+00	3.86E+00	3.86E+00	3.85E+00	3.86E+00	3.86E+00
Ps99%/90% (-KTL) Un-Biased	3.79E+00	3.79E+00	3.79E+00	3.79E+00	3.78E+00	3.79E+00	3.79E+00
<b>Specification MIN</b>	<b>3.40E+00</b>	<b>3.40E+00</b>	<b>3.20E+00</b>	<b>3.20E+00</b>	<b>3.00E+00</b>	<b>3.00E+00</b>	<b>3.00E+00</b>
Status	PASS	PASS	PASS	PASS	PASS	PASS	PASS

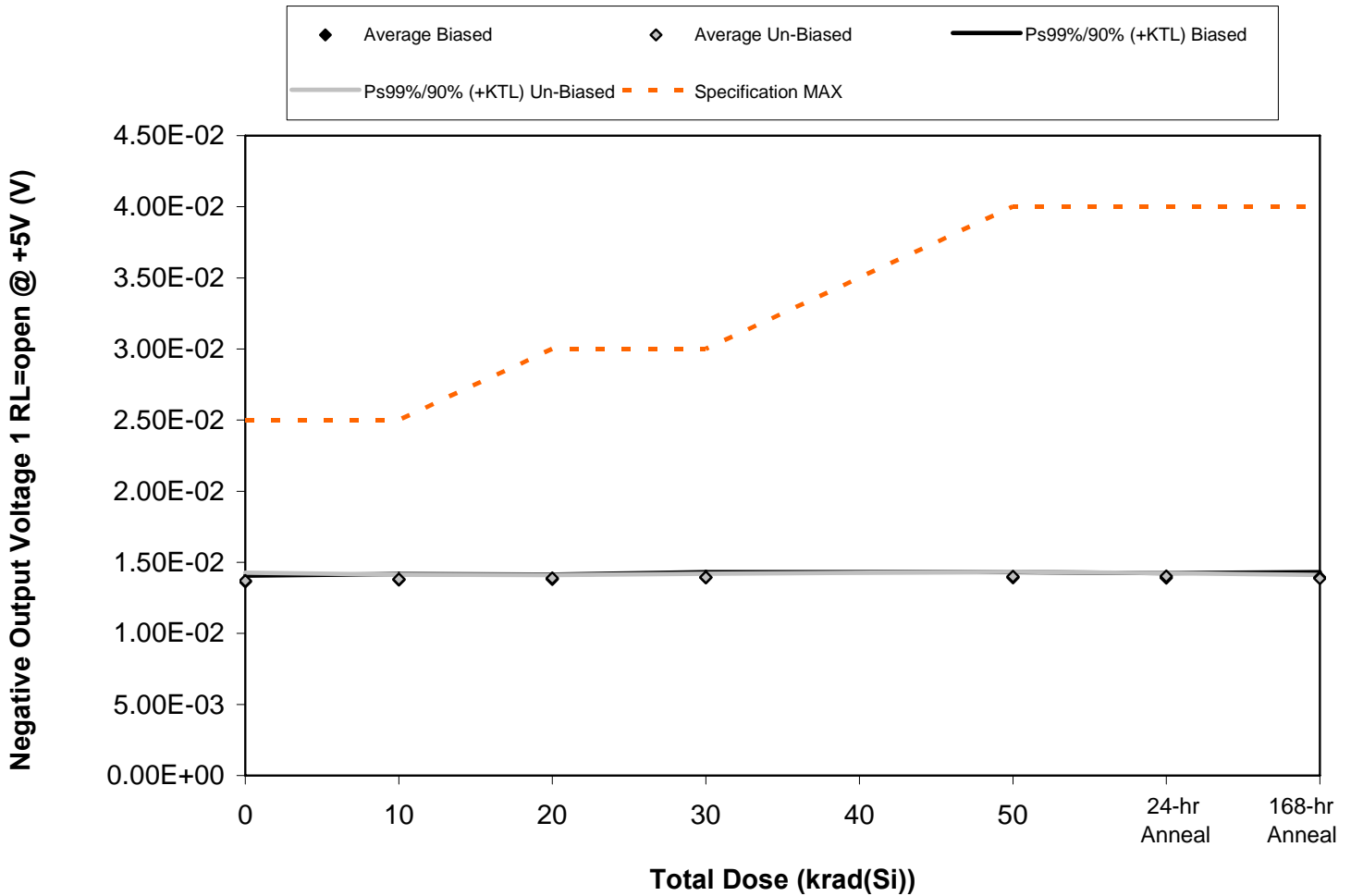

Figure 5.73. Plot of Negative Output Voltage 1 RL=open @ +5V (V) versus total dose. The data show no significant degradation with radiation. The solid diamonds are the average of measured data points from the biased sample (devices irradiated with an electrical bias) while the shaded diamonds are the average from the unbiased sample. The black lines show the effects on the data after application of the biased KTL statistics (solid and dashed lines) while the gray lines show the effects on the data after application of the unbiased KTL statistics (solid and dashed lines). The red dashed lines are the minimum and maximum specification values as defined in the datasheet and/or test plan.





Table 5.73. Raw data for Negative Output Voltage 1 RL=open @ +5V (V) versus total dose, including the statistical analysis, the specification and the status of the testing (pass/fail).

Negative Output Voltage 1 RL=open @ +5V (V)	Total Dose (krad(Si))					24-hr Anneal	168-hr Anneal
	0	10	20	30	50		
Device							
1027	1.37E-02	1.37E-02	1.38E-02	1.39E-02	1.40E-02	1.39E-02	1.40E-02
1029	1.37E-02	1.38E-02	1.38E-02	1.39E-02	1.38E-02	1.39E-02	1.39E-02
1030	1.35E-02	1.38E-02	1.38E-02	1.40E-02	1.39E-02	1.40E-02	1.38E-02
1031	1.37E-02	1.39E-02	1.39E-02	1.40E-02	1.40E-02	1.39E-02	1.40E-02
1032	1.36E-02	1.37E-02	1.37E-02	1.38E-02	1.39E-02	1.38E-02	1.39E-02
1033	1.36E-02	1.37E-02	1.39E-02	1.40E-02	1.39E-02	1.40E-02	1.38E-02
1034	1.39E-02	1.39E-02	1.39E-02	1.39E-02	1.40E-02	1.41E-02	1.39E-02
1035	1.37E-02	1.38E-02	1.38E-02	1.39E-02	1.40E-02	1.40E-02	1.38E-02
1036	1.37E-02	1.38E-02	1.39E-02	1.39E-02	1.41E-02	1.40E-02	1.39E-02
1038	1.36E-02	1.38E-02	1.39E-02	1.40E-02	1.40E-02	1.40E-02	1.39E-02
1039	1.37E-02	1.38E-02	1.38E-02	1.38E-02	1.37E-02	1.37E-02	1.38E-02
<b>Biased Statistics</b>							
Average Biased	1.36E-02	1.38E-02	1.38E-02	1.39E-02	1.39E-02	1.39E-02	1.39E-02
Std Dev Biased	8.94E-05	8.37E-05	7.07E-05	8.37E-05	8.37E-05	7.07E-05	8.37E-05
Ps99%/90% (+KTL) Biased	1.41E-02	1.42E-02	1.41E-02	1.43E-02	1.43E-02	1.42E-02	1.43E-02
Ps99%/90% (-KTL) Biased	1.32E-02	1.34E-02	1.35E-02	1.35E-02	1.35E-02	1.36E-02	1.35E-02
<b>Un-Biased Statistics</b>							
Average Un-Biased	1.37E-02	1.38E-02	1.39E-02	1.39E-02	1.40E-02	1.40E-02	1.39E-02
Std Dev Un-Biased	1.22E-04	7.07E-05	4.47E-05	5.48E-05	7.07E-05	4.47E-05	5.48E-05
Ps99%/90% (+KTL) Un-Biased	1.43E-02	1.41E-02	1.41E-02	1.42E-02	1.43E-02	1.42E-02	1.41E-02
Ps99%/90% (-KTL) Un-Biased	1.31E-02	1.35E-02	1.37E-02	1.37E-02	1.37E-02	1.38E-02	1.36E-02
<b>Specification MAX</b>	<b>2.50E-02</b>	<b>2.50E-02</b>	<b>3.00E-02</b>	<b>3.00E-02</b>	<b>4.00E-02</b>	<b>4.00E-02</b>	<b>4.00E-02</b>
Status	PASS	PASS	PASS	PASS	PASS	PASS	PASS

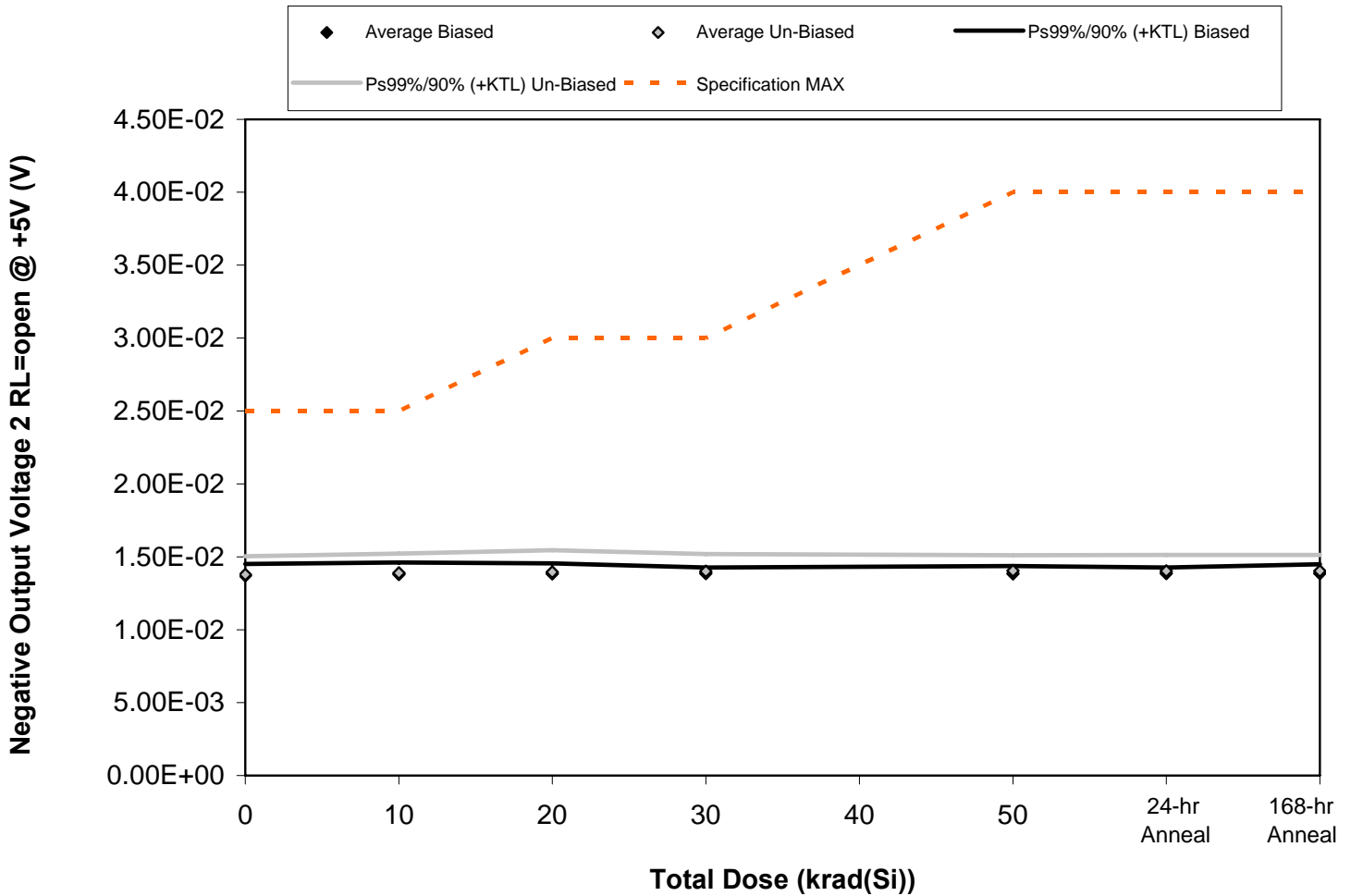

Figure 5.74. Plot of Negative Output Voltage 2 RL=open @ +5V (V) versus total dose. The data show no significant degradation with radiation. The solid diamonds are the average of measured data points from the biased sample (devices irradiated with an electrical bias) while the shaded diamonds are the average from the unbiased sample. The black lines show the effects on the data after application of the biased KTL statistics (solid and dashed lines) while the gray lines show the effects on the data after application of the unbiased KTL statistics (solid and dashed lines). The red dashed lines are the minimum and maximum specification values as defined in the datasheet and/or test plan.



Table 5.74. Raw data for Negative Output Voltage 2 RL=open @ +5V (V) versus total dose, including the statistical analysis, the specification and the status of the testing (pass/fail).

Negative Output Voltage 2 RL=open @ +5V (V)	Total Dose (krad(Si))					24-hr Anneal	168-hr Anneal
	0	10	20	30	50		
Device							
1027	1.37E-02	1.37E-02	1.38E-02	1.38E-02	1.38E-02	1.38E-02	1.38E-02
1029	1.36E-02	1.38E-02	1.38E-02	1.38E-02	1.39E-02	1.38E-02	1.38E-02
1030	1.40E-02	1.41E-02	1.41E-02	1.40E-02	1.40E-02	1.40E-02	1.41E-02
1031	1.36E-02	1.37E-02	1.37E-02	1.38E-02	1.38E-02	1.38E-02	1.38E-02
1032	1.36E-02	1.37E-02	1.38E-02	1.39E-02	1.37E-02	1.39E-02	1.38E-02
1033	1.36E-02	1.37E-02	1.37E-02	1.38E-02	1.38E-02	1.39E-02	1.39E-02
1034	1.42E-02	1.43E-02	1.44E-02	1.44E-02	1.44E-02	1.44E-02	1.44E-02
1035	1.39E-02	1.41E-02	1.42E-02	1.41E-02	1.41E-02	1.41E-02	1.41E-02
1036	1.36E-02	1.37E-02	1.38E-02	1.38E-02	1.39E-02	1.38E-02	1.38E-02
1038	1.36E-02	1.37E-02	1.37E-02	1.39E-02	1.40E-02	1.39E-02	1.39E-02
1039	1.36E-02	1.37E-02	1.39E-02	1.38E-02	1.37E-02	1.37E-02	1.38E-02
<b>Biased Statistics</b>							
Average Biased	1.37E-02	1.38E-02	1.38E-02	1.39E-02	1.38E-02	1.39E-02	1.39E-02
Std Dev Biased	1.73E-04	1.73E-04	1.52E-04	8.94E-05	1.14E-04	8.94E-05	1.34E-04
Ps99%/90% (+KTL) Biased	1.45E-02	1.46E-02	1.45E-02	1.43E-02	1.44E-02	1.43E-02	1.45E-02
Ps99%/90% (-KTL) Biased	1.29E-02	1.30E-02	1.31E-02	1.34E-02	1.33E-02	1.34E-02	1.32E-02
<b>Un-Biased Statistics</b>							
Average Un-Biased	1.38E-02	1.39E-02	1.40E-02	1.40E-02	1.40E-02	1.40E-02	1.40E-02
Std Dev Un-Biased	2.68E-04	2.83E-04	3.21E-04	2.55E-04	2.30E-04	2.39E-04	2.39E-04
Ps99%/90% (+KTL) Un-Biased	1.50E-02	1.52E-02	1.55E-02	1.52E-02	1.51E-02	1.51E-02	1.51E-02
Ps99%/90% (-KTL) Un-Biased	1.25E-02	1.26E-02	1.25E-02	1.28E-02	1.30E-02	1.29E-02	1.29E-02
<b>Specification MAX</b>	<b>2.50E-02</b>	<b>2.50E-02</b>	<b>3.00E-02</b>	<b>3.00E-02</b>	<b>4.00E-02</b>	<b>4.00E-02</b>	<b>4.00E-02</b>
Status	PASS	PASS	PASS	PASS	PASS	PASS	PASS

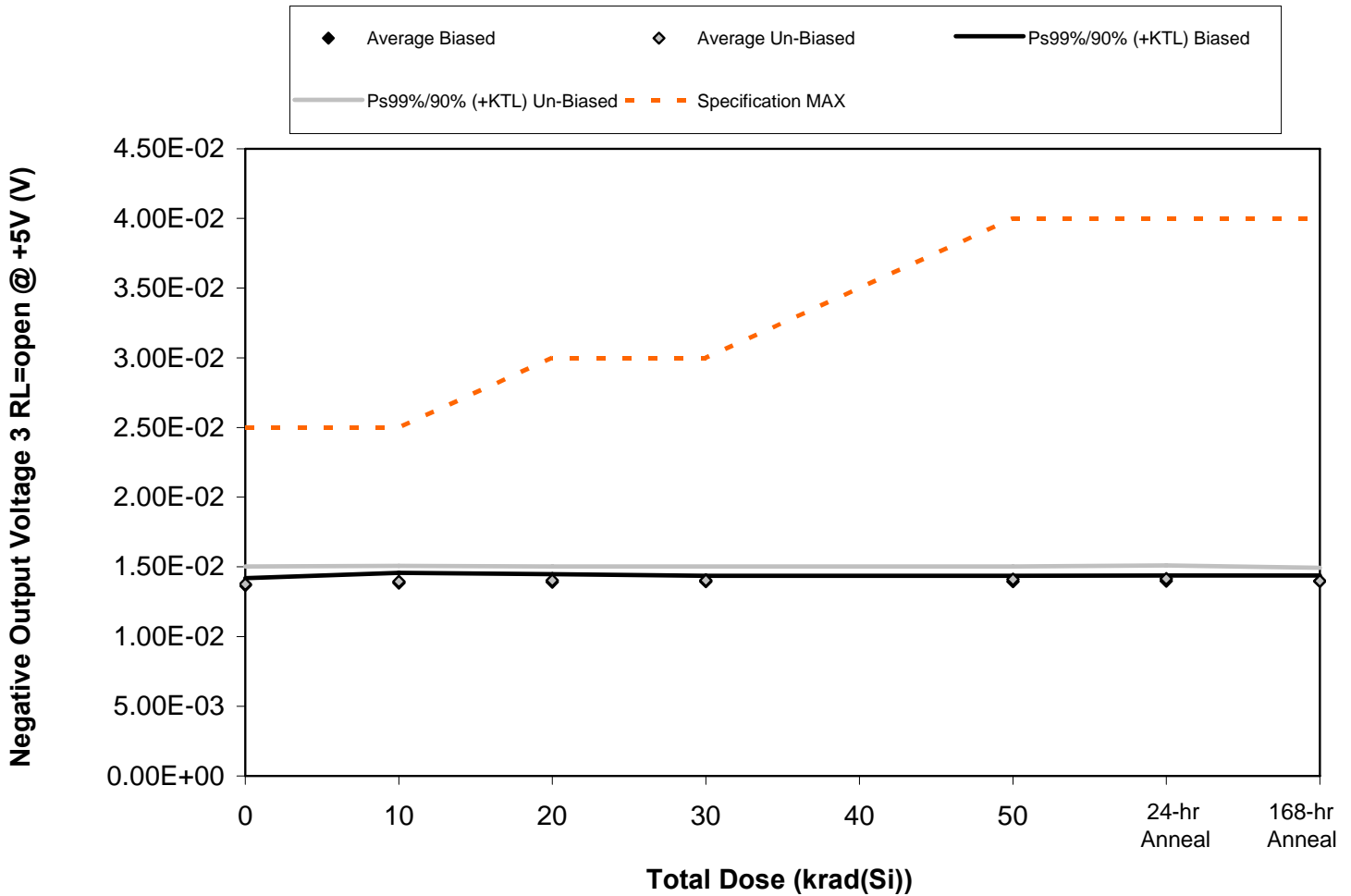

Figure 5.75. Plot of Negative Output Voltage 3 RL=open @ +5V (V) versus total dose. The data show no significant degradation with radiation. The solid diamonds are the average of measured data points from the biased sample (devices irradiated with an electrical bias) while the shaded diamonds are the average from the unbiased sample. The black lines show the effects on the data after application of the biased KTL statistics (solid and dashed lines) while the gray lines show the effects on the data after application of the unbiased KTL statistics (solid and dashed lines). The red dashed lines are the minimum and maximum specification values as defined in the datasheet and/or test plan.



Table 5.75. Raw data for Negative Output Voltage 3 RL=open @ +5V (V) versus total dose, including the statistical analysis, the specification and the status of the testing (pass/fail).

Negative Output Voltage 3 RL=open @ +5V (V)	Total Dose (krad(Si))					24-hr Anneal	168-hr Anneal
	0	10	20	30	50		
Device							
1027	1.38E-02	1.38E-02	1.39E-02	1.39E-02	1.40E-02	1.40E-02	1.40E-02
1029	1.36E-02	1.38E-02	1.39E-02	1.39E-02	1.38E-02	1.40E-02	1.39E-02
1030	1.38E-02	1.41E-02	1.41E-02	1.41E-02	1.40E-02	1.41E-02	1.41E-02
1031	1.36E-02	1.39E-02	1.38E-02	1.39E-02	1.40E-02	1.39E-02	1.39E-02
1032	1.36E-02	1.37E-02	1.38E-02	1.39E-02	1.39E-02	1.39E-02	1.39E-02
1033	1.35E-02	1.37E-02	1.39E-02	1.38E-02	1.40E-02	1.39E-02	1.39E-02
1034	1.40E-02	1.42E-02	1.42E-02	1.42E-02	1.42E-02	1.43E-02	1.42E-02
1035	1.41E-02	1.42E-02	1.43E-02	1.43E-02	1.44E-02	1.44E-02	1.42E-02
1036	1.36E-02	1.38E-02	1.38E-02	1.39E-02	1.39E-02	1.40E-02	1.38E-02
1038	1.36E-02	1.38E-02	1.39E-02	1.39E-02	1.40E-02	1.41E-02	1.38E-02
1039	1.38E-02	1.38E-02	1.39E-02	1.38E-02	1.38E-02	1.37E-02	1.39E-02
<b>Biased Statistics</b>							
Average Biased	1.37E-02	1.39E-02	1.39E-02	1.39E-02	1.39E-02	1.40E-02	1.40E-02
Std Dev Biased	1.10E-04	1.52E-04	1.22E-04	8.94E-05	8.94E-05	8.37E-05	8.94E-05
Ps99%/90% (+KTL) Biased	1.42E-02	1.46E-02	1.45E-02	1.44E-02	1.44E-02	1.44E-02	1.44E-02
Ps99%/90% (-KTL) Biased	1.32E-02	1.32E-02	1.33E-02	1.35E-02	1.35E-02	1.36E-02	1.35E-02
<b>Un-Biased Statistics</b>							
Average Un-Biased	1.38E-02	1.39E-02	1.40E-02	1.40E-02	1.41E-02	1.41E-02	1.40E-02
Std Dev Un-Biased	2.70E-04	2.41E-04	2.17E-04	2.17E-04	2.00E-04	2.07E-04	2.05E-04
Ps99%/90% (+KTL) Un-Biased	1.50E-02	1.51E-02	1.50E-02	1.50E-02	1.50E-02	1.51E-02	1.49E-02
Ps99%/90% (-KTL) Un-Biased	1.25E-02	1.28E-02	1.30E-02	1.30E-02	1.32E-02	1.32E-02	1.30E-02
<b>Specification MAX</b>	<b>2.50E-02</b>	<b>2.50E-02</b>	<b>3.00E-02</b>	<b>3.00E-02</b>	<b>4.00E-02</b>	<b>4.00E-02</b>	<b>4.00E-02</b>
Status	PASS	PASS	PASS	PASS	PASS	PASS	PASS

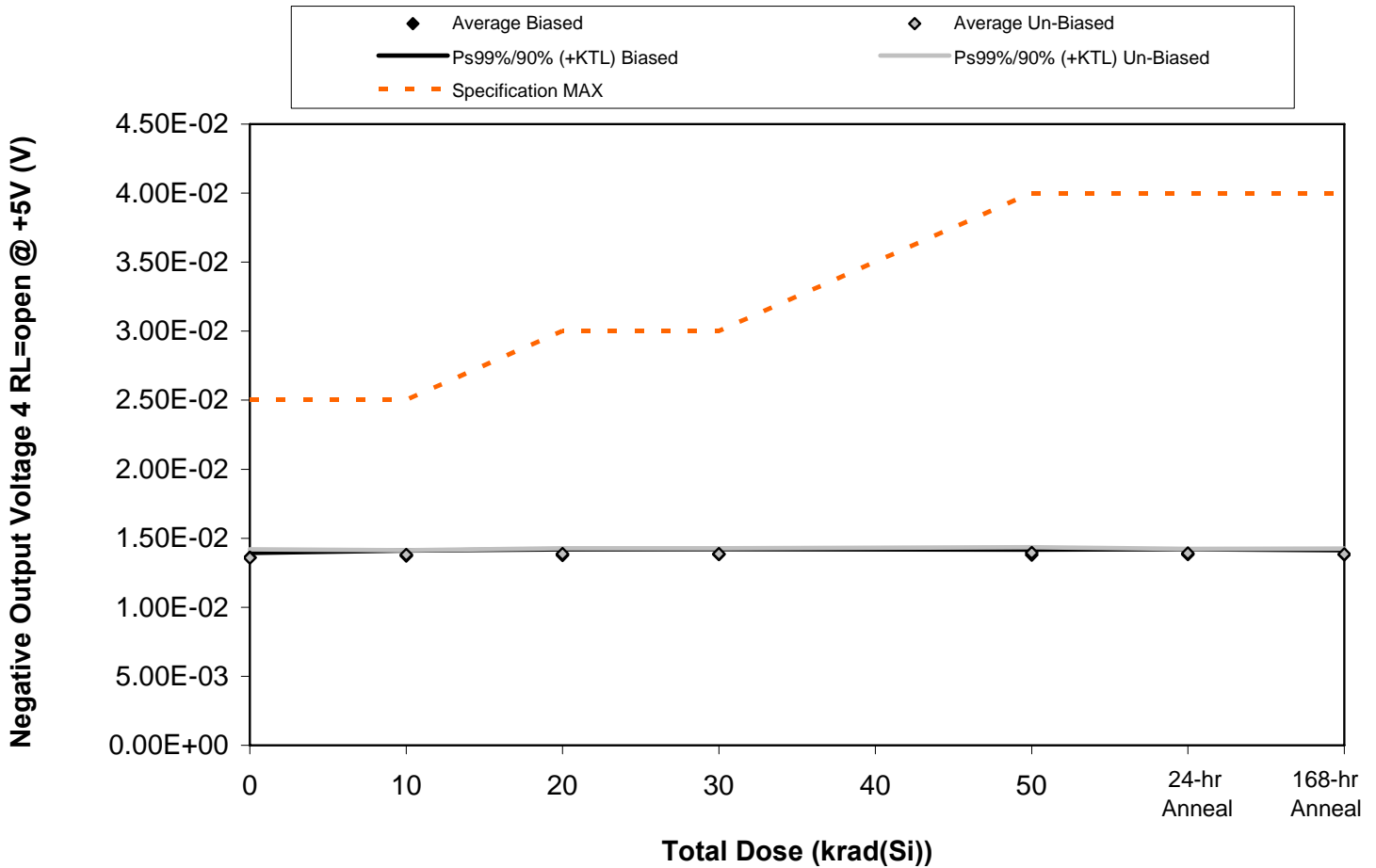

Figure 5.76. Plot of Negative Output Voltage 4 RL=open @ +5V (V) versus total dose. The data show no significant degradation with radiation. The solid diamonds are the average of measured data points from the biased sample (devices irradiated with an electrical bias) while the shaded diamonds are the average from the unbiased sample. The black lines show the effects on the data after application of the biased KTL statistics (solid and dashed lines) while the gray lines show the effects on the data after application of the unbiased KTL statistics (solid and dashed lines). The red dashed lines are the minimum and maximum specification values as defined in the datasheet and/or test plan.



Table 5.76. Raw data for Negative Output Voltage 4 RL=open @ +5V (V) versus total dose, including the statistical analysis, the specification and the status of the testing (pass/fail).

Negative Output Voltage 4 RL=open @ +5V (V)	Total Dose (krad(Si))					24-hr Anneal	168-hr Anneal
	0	10	20	30	50		
Device							
1027	1.36E-02	1.38E-02	1.38E-02	1.39E-02	1.39E-02	1.39E-02	1.39E-02
1029	1.36E-02	1.36E-02	1.38E-02	1.38E-02	1.38E-02	1.39E-02	1.38E-02
1030	1.37E-02	1.37E-02	1.38E-02	1.37E-02	1.37E-02	1.38E-02	1.38E-02
1031	1.36E-02	1.38E-02	1.38E-02	1.39E-02	1.38E-02	1.38E-02	1.38E-02
1032	1.35E-02	1.37E-02	1.36E-02	1.38E-02	1.37E-02	1.37E-02	1.37E-02
1033	1.35E-02	1.38E-02	1.38E-02	1.38E-02	1.39E-02	1.39E-02	1.38E-02
1034	1.38E-02	1.39E-02	1.40E-02	1.40E-02	1.41E-02	1.40E-02	1.40E-02
1035	1.35E-02	1.38E-02	1.39E-02	1.38E-02	1.39E-02	1.39E-02	1.38E-02
1036	1.36E-02	1.37E-02	1.38E-02	1.38E-02	1.39E-02	1.39E-02	1.38E-02
1038	1.35E-02	1.38E-02	1.38E-02	1.39E-02	1.39E-02	1.38E-02	1.38E-02
1039	1.38E-02	1.38E-02	1.36E-02	1.38E-02	1.36E-02	1.37E-02	1.37E-02
<b>Biased Statistics</b>							
Average Biased	1.36E-02	1.37E-02	1.38E-02	1.38E-02	1.38E-02	1.38E-02	1.38E-02
Std Dev Biased	7.07E-05	8.37E-05	8.94E-05	8.37E-05	8.37E-05	8.37E-05	7.07E-05
Ps99%/90% (+KTL) Biased	1.39E-02	1.41E-02	1.42E-02	1.42E-02	1.42E-02	1.42E-02	1.41E-02
Ps99%/90% (-KTL) Biased	1.33E-02	1.33E-02	1.33E-02	1.34E-02	1.34E-02	1.34E-02	1.35E-02
<b>Un-Biased Statistics</b>							
Average Un-Biased	1.36E-02	1.38E-02	1.39E-02	1.39E-02	1.39E-02	1.39E-02	1.38E-02
Std Dev Un-Biased	1.30E-04	7.07E-05	8.94E-05	8.94E-05	8.94E-05	7.07E-05	8.94E-05
Ps99%/90% (+KTL) Un-Biased	1.42E-02	1.41E-02	1.43E-02	1.43E-02	1.44E-02	1.42E-02	1.43E-02
Ps99%/90% (-KTL) Un-Biased	1.30E-02	1.35E-02	1.34E-02	1.34E-02	1.35E-02	1.36E-02	1.34E-02
<b>Specification MAX</b>	<b>2.50E-02</b>	<b>2.50E-02</b>	<b>3.00E-02</b>	<b>3.00E-02</b>	<b>4.00E-02</b>	<b>4.00E-02</b>	<b>4.00E-02</b>
Status	PASS	PASS	PASS	PASS	PASS	PASS	PASS

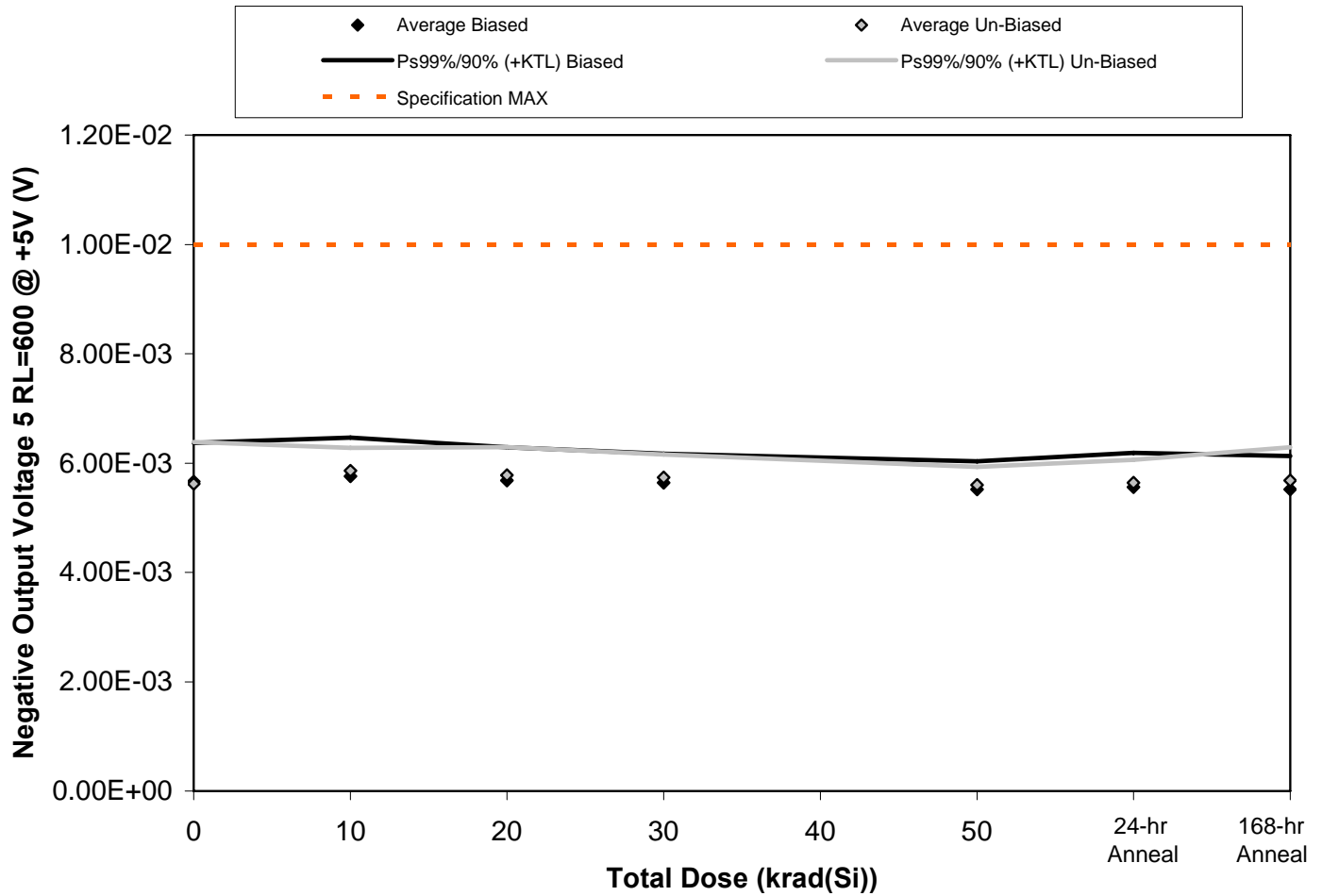

Figure 5.77. Plot of Negative Output Voltage 5 RL=600 @ +5V (V) versus total dose. The data show no significant degradation with radiation. The solid diamonds are the average of measured data points from the biased sample (devices irradiated with an electrical bias) while the shaded diamonds are the average from the unbiased sample. The black lines show the effects on the data after application of the biased KTL statistics (solid and dashed lines) while the gray lines show the effects on the data after application of the unbiased KTL statistics (solid and dashed lines). The red dashed lines are the minimum and maximum specification values as defined in the datasheet and/or test plan.





Table 5.77. Raw data for Negative Output Voltage 5 RL=600 @ +5V (V) versus total dose, including the statistical analysis, the specification and the status of the testing (pass/fail).

Negative Output Voltage 5 RL=600 @ +5V (V)	Total Dose (krad(Si))					24-hr Anneal	168-hr Anneal
	0	10	20	30	50		
Device							
1027	5.70E-03	6.00E-03	5.90E-03	5.80E-03	5.70E-03	5.80E-03	5.70E-03
1029	5.60E-03	5.70E-03	5.60E-03	5.60E-03	5.50E-03	5.50E-03	5.40E-03
1030	5.50E-03	5.70E-03	5.60E-03	5.50E-03	5.40E-03	5.50E-03	5.40E-03
1031	5.90E-03	5.80E-03	5.70E-03	5.70E-03	5.50E-03	5.50E-03	5.60E-03
1032	5.60E-03	5.60E-03	5.60E-03	5.60E-03	5.50E-03	5.50E-03	5.50E-03
1033	5.40E-03	5.70E-03	5.60E-03	5.60E-03	5.50E-03	5.50E-03	5.50E-03
1034	5.70E-03	5.90E-03	5.90E-03	5.80E-03	5.60E-03	5.70E-03	5.60E-03
1035	5.50E-03	5.90E-03	5.80E-03	5.70E-03	5.60E-03	5.60E-03	5.70E-03
1036	5.70E-03	5.90E-03	5.80E-03	5.80E-03	5.60E-03	5.70E-03	5.80E-03
1038	5.80E-03	5.90E-03	5.80E-03	5.80E-03	5.70E-03	5.70E-03	5.80E-03
1039	5.70E-03	5.80E-03	5.90E-03	5.80E-03	5.80E-03	5.80E-03	5.80E-03
<b>Biased Statistics</b>							
Average Biased	5.66E-03	5.76E-03	5.68E-03	5.64E-03	5.52E-03	5.56E-03	5.52E-03
Std Dev Biased	1.52E-04	1.52E-04	1.30E-04	1.14E-04	1.10E-04	1.34E-04	1.30E-04
Ps99%/90% (+KTL) Biased	6.37E-03	6.47E-03	6.29E-03	6.17E-03	6.03E-03	6.19E-03	6.13E-03
Ps99%/90% (-KTL) Biased	4.95E-03	5.05E-03	5.07E-03	5.11E-03	5.01E-03	4.93E-03	4.91E-03
<b>Un-Biased Statistics</b>							
Average Un-Biased	5.62E-03	5.86E-03	5.78E-03	5.74E-03	5.60E-03	5.64E-03	5.68E-03
Std Dev Un-Biased	1.64E-04	8.94E-05	1.10E-04	8.94E-05	7.07E-05	8.94E-05	1.30E-04
Ps99%/90% (+KTL) Un-Biased	6.39E-03	6.28E-03	6.29E-03	6.16E-03	5.93E-03	6.06E-03	6.29E-03
Ps99%/90% (-KTL) Un-Biased	4.85E-03	5.44E-03	5.27E-03	5.32E-03	5.27E-03	5.22E-03	5.07E-03
<b>Specification MAX</b>	<b>1.00E-02</b>	<b>1.00E-02</b>	<b>1.00E-02</b>	<b>1.00E-02</b>	<b>1.00E-02</b>	<b>1.00E-02</b>	<b>1.00E-02</b>
Status	PASS	PASS	PASS	PASS	PASS	PASS	PASS

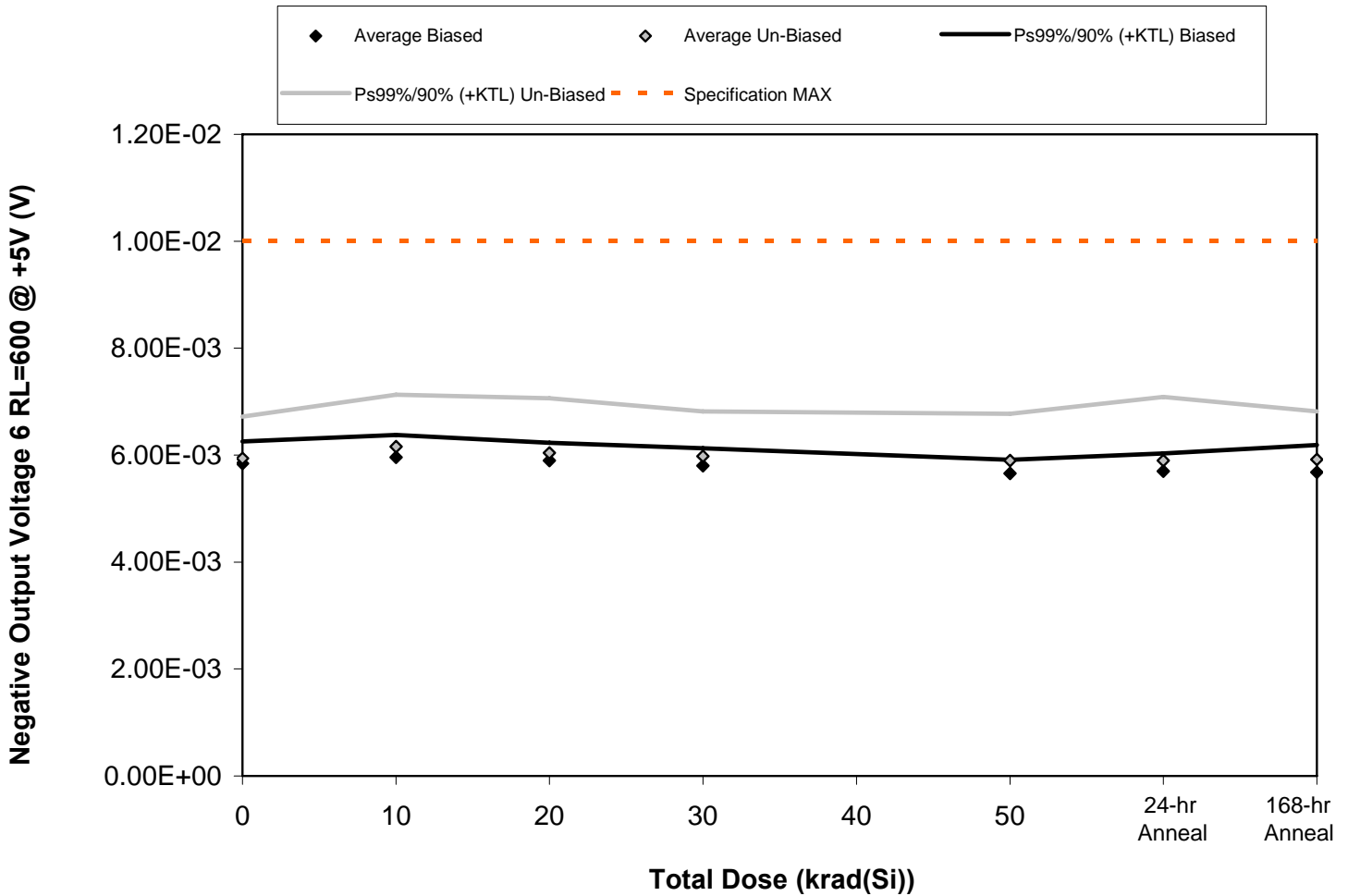

Figure 5.78. Plot of Negative Output Voltage 6 RL=600 @ +5V (V) versus total dose. The data show no significant degradation with radiation. The solid diamonds are the average of measured data points from the biased sample (devices irradiated with an electrical bias) while the shaded diamonds are the average from the unbiased sample. The black lines show the effects on the data after application of the biased KTL statistics (solid and dashed lines) while the gray lines show the effects on the data after application of the unbiased KTL statistics (solid and dashed lines). The red dashed lines are the minimum and maximum specification values as defined in the datasheet and/or test plan.



Table 5.78. Raw data for Negative Output Voltage 6 RL=600 @ +5V (V) versus total dose, including the statistical analysis, the specification and the status of the testing (pass/fail).

Negative Output Voltage 6 RL=600 @ +5V (V)	Total Dose (krad(Si))					24-hr Anneal	168-hr Anneal
	0	10	20	30	50		
Device							
1027	5.80E-03	6.00E-03	5.90E-03	5.80E-03	5.60E-03	5.70E-03	5.70E-03
1029	5.80E-03	5.90E-03	5.90E-03	5.80E-03	5.70E-03	5.70E-03	5.70E-03
1030	6.00E-03	6.10E-03	6.00E-03	5.90E-03	5.70E-03	5.80E-03	5.80E-03
1031	5.80E-03	5.90E-03	5.80E-03	5.70E-03	5.70E-03	5.70E-03	5.50E-03
1032	5.80E-03	5.90E-03	5.90E-03	5.80E-03	5.60E-03	5.60E-03	5.70E-03
1033	5.90E-03	6.10E-03	5.90E-03	6.00E-03	5.90E-03	5.80E-03	5.90E-03
1034	6.20E-03	6.50E-03	6.40E-03	6.20E-03	6.20E-03	6.30E-03	6.20E-03
1035	6.00E-03	6.20E-03	6.10E-03	6.10E-03	5.90E-03	6.00E-03	6.00E-03
1036	5.80E-03	6.00E-03	5.90E-03	5.80E-03	5.80E-03	5.70E-03	5.80E-03
1038	5.80E-03	6.00E-03	5.90E-03	5.80E-03	5.70E-03	5.70E-03	5.70E-03
1039	6.10E-03	6.20E-03	6.20E-03	6.10E-03	6.10E-03	6.10E-03	6.20E-03
<b>Biased Statistics</b>							
Average Biased	5.84E-03	5.96E-03	5.90E-03	5.80E-03	5.66E-03	5.70E-03	5.68E-03
Std Dev Biased	8.94E-05	8.94E-05	7.07E-05	7.07E-05	5.48E-05	7.07E-05	1.10E-04
Ps99%/90% (+KTL) Biased	6.26E-03	6.38E-03	6.23E-03	6.13E-03	5.92E-03	6.03E-03	6.19E-03
Ps99%/90% (-KTL) Biased	5.42E-03	5.54E-03	5.57E-03	5.47E-03	5.40E-03	5.37E-03	5.17E-03
<b>Un-Biased Statistics</b>							
Average Un-Biased	5.94E-03	6.16E-03	6.04E-03	5.98E-03	5.90E-03	5.90E-03	5.92E-03
Std Dev Un-Biased	1.67E-04	2.07E-04	2.19E-04	1.79E-04	1.87E-04	2.55E-04	1.92E-04
Ps99%/90% (+KTL) Un-Biased	6.72E-03	7.13E-03	7.06E-03	6.81E-03	6.77E-03	7.09E-03	6.82E-03
Ps99%/90% (-KTL) Un-Biased	5.16E-03	5.19E-03	5.02E-03	5.15E-03	5.03E-03	4.71E-03	5.02E-03
<b>Specification MAX</b>	<b>1.00E-02</b>	<b>1.00E-02</b>	<b>1.00E-02</b>	<b>1.00E-02</b>	<b>1.00E-02</b>	<b>1.00E-02</b>	<b>1.00E-02</b>
Status	PASS	PASS	PASS	PASS	PASS	PASS	PASS

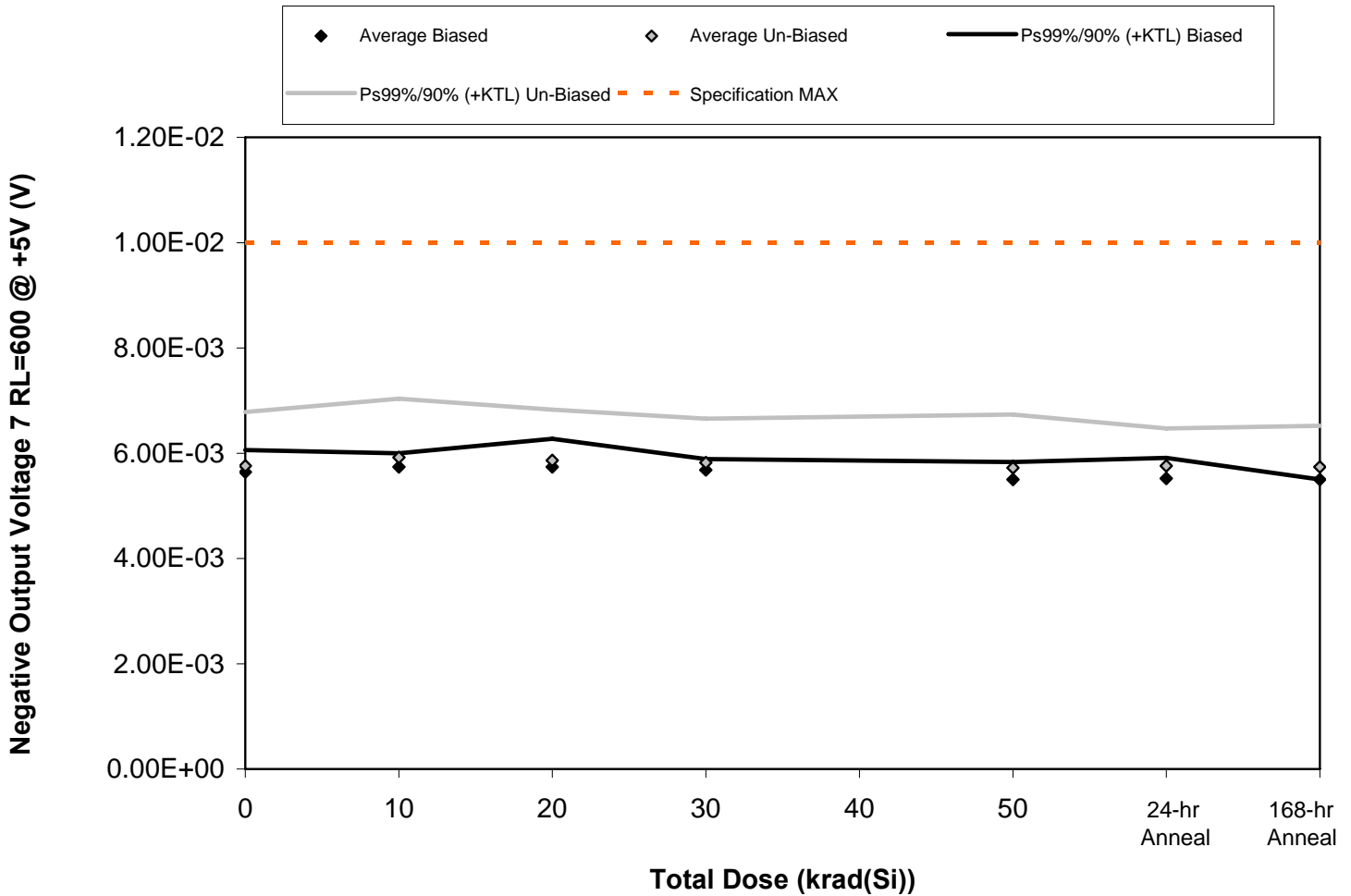

Figure 5.79. Plot of Negative Output Voltage 7 RL=600 @ +5V (V) versus total dose. The data show no significant degradation with radiation. The solid diamonds are the average of measured data points from the biased sample (devices irradiated with an electrical bias) while the shaded diamonds are the average from the unbiased sample. The black lines show the effects on the data after application of the biased KTL statistics (solid and dashed lines) while the gray lines show the effects on the data after application of the unbiased KTL statistics (solid and dashed lines). The red dashed lines are the minimum and maximum specification values as defined in the datasheet and/or test plan.



Table 5.79. Raw data for Negative Output Voltage 7 RL=600 @ +5V (V) versus total dose, including the statistical analysis, the specification and the status of the testing (pass/fail).

Negative Output Voltage 7 RL=600 @ +5V (V)	Total Dose (krad(Si))					24-hr Anneal	168-hr Anneal
	0	10	20	30	50		
Device							
1027	5.60E-03	5.80E-03	5.60E-03	5.70E-03	5.50E-03	5.50E-03	5.50E-03
1029	5.70E-03	5.70E-03	5.70E-03	5.70E-03	5.60E-03	5.60E-03	5.50E-03
1030	5.70E-03	5.80E-03	5.90E-03	5.70E-03	5.50E-03	5.60E-03	5.50E-03
1031	5.50E-03	5.70E-03	5.70E-03	5.60E-03	5.40E-03	5.40E-03	5.50E-03
1032	5.70E-03	5.70E-03	5.80E-03	5.70E-03	5.50E-03	5.50E-03	5.50E-03
1033	5.60E-03	5.80E-03	5.80E-03	5.70E-03	5.60E-03	5.70E-03	5.70E-03
1034	6.00E-03	6.30E-03	6.20E-03	6.10E-03	6.00E-03	6.00E-03	6.00E-03
1035	6.00E-03	6.00E-03	5.90E-03	5.90E-03	5.90E-03	5.80E-03	5.80E-03
1036	5.60E-03	5.80E-03	5.70E-03	5.70E-03	5.50E-03	5.70E-03	5.60E-03
1038	5.60E-03	5.70E-03	5.70E-03	5.70E-03	5.60E-03	5.60E-03	5.60E-03
1039	5.90E-03	6.10E-03	6.00E-03	6.00E-03	5.90E-03	5.90E-03	6.00E-03
<b>Biased Statistics</b>							
Average Biased	5.64E-03	5.74E-03	5.74E-03	5.68E-03	5.50E-03	5.52E-03	5.50E-03
Std Dev Biased	8.94E-05	5.48E-05	1.14E-04	4.47E-05	7.07E-05	8.37E-05	#####
Ps99%/90% (+KTL) Biased	6.06E-03	6.00E-03	6.27E-03	5.89E-03	5.83E-03	5.91E-03	5.50E-03
Ps99%/90% (-KTL) Biased	5.22E-03	5.48E-03	5.21E-03	5.47E-03	5.17E-03	5.13E-03	5.50E-03
<b>Un-Biased Statistics</b>							
Average Un-Biased	5.76E-03	5.92E-03	5.86E-03	5.82E-03	5.72E-03	5.76E-03	5.74E-03
Std Dev Un-Biased	2.19E-04	2.39E-04	2.07E-04	1.79E-04	2.17E-04	1.52E-04	1.67E-04
Ps99%/90% (+KTL) Un-Biased	6.78E-03	7.03E-03	6.83E-03	6.65E-03	6.73E-03	6.47E-03	6.52E-03
Ps99%/90% (-KTL) Un-Biased	4.74E-03	4.81E-03	4.89E-03	4.99E-03	4.71E-03	5.05E-03	4.96E-03
<b>Specification MAX</b>	<b>1.00E-02</b>	<b>1.00E-02</b>	<b>1.00E-02</b>	<b>1.00E-02</b>	<b>1.00E-02</b>	<b>1.00E-02</b>	<b>1.00E-02</b>
Status	PASS	PASS	PASS	PASS	PASS	PASS	PASS

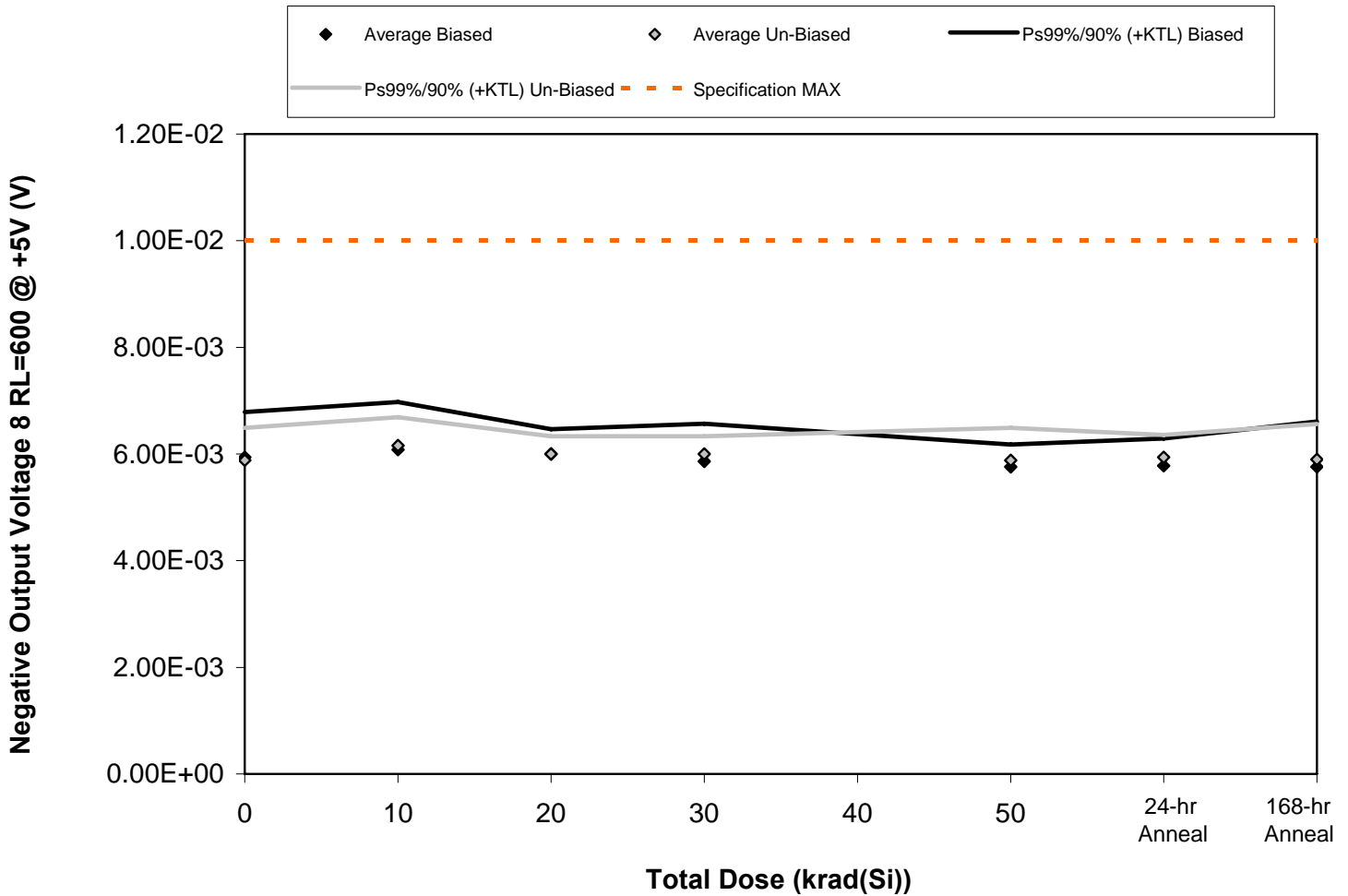

Figure 5.80. Plot of Negative Output Voltage 8 RL=600 @ +5V (V) versus total dose. The data show no significant degradation with radiation. The solid diamonds are the average of measured data points from the biased sample (devices irradiated with an electrical bias) while the shaded diamonds are the average from the unbiased sample. The black lines show the effects on the data after application of the biased KTL statistics (solid and dashed lines) while the gray lines show the effects on the data after application of the unbiased KTL statistics (solid and dashed lines). The red dashed lines are the minimum and maximum specification values as defined in the datasheet and/or test plan.



Table 5.80. Raw data for Negative Output Voltage 8 RL=600 @ +5V (V) versus total dose, including the statistical analysis, the specification and the status of the testing (pass/fail).

Negative Output Voltage 8 RL=600 @ +5V (V)	Total Dose (krad(Si))					24-hr Anneal	168-hr Anneal
	0	10	20	30	50		
Device							
1027	6.20E-03	6.40E-03	6.10E-03	6.10E-03	5.90E-03	5.90E-03	6.00E-03
1029	5.90E-03	5.90E-03	6.00E-03	5.80E-03	5.70E-03	5.70E-03	5.60E-03
1030	5.70E-03	6.00E-03	5.90E-03	5.70E-03	5.70E-03	5.70E-03	5.60E-03
1031	6.00E-03	6.10E-03	6.10E-03	5.90E-03	5.80E-03	5.90E-03	5.90E-03
1032	5.90E-03	6.00E-03	5.90E-03	5.80E-03	5.70E-03	5.70E-03	5.70E-03
1033	5.70E-03	6.00E-03	5.90E-03	5.90E-03	5.70E-03	5.80E-03	5.70E-03
1034	5.90E-03	6.20E-03	6.00E-03	6.00E-03	5.90E-03	5.90E-03	5.90E-03
1035	5.80E-03	6.10E-03	6.00E-03	6.00E-03	5.80E-03	6.00E-03	5.90E-03
1036	6.00E-03	6.30E-03	6.10E-03	6.10E-03	6.00E-03	6.00E-03	6.10E-03
1038	6.00E-03	6.20E-03	6.00E-03	6.00E-03	6.00E-03	6.00E-03	5.90E-03
1039	5.90E-03	6.20E-03	6.00E-03	6.00E-03	5.90E-03	6.00E-03	6.00E-03
<b>Biased Statistics</b>							
Average Biased	5.94E-03	6.08E-03	6.00E-03	5.86E-03	5.76E-03	5.78E-03	5.76E-03
Std Dev Biased	1.82E-04	1.92E-04	1.00E-04	1.52E-04	8.94E-05	1.10E-04	1.82E-04
Ps99%/90% (+KTL) Biased	6.79E-03	6.98E-03	6.47E-03	6.57E-03	6.18E-03	6.29E-03	6.61E-03
Ps99%/90% (-KTL) Biased	5.09E-03	5.18E-03	5.53E-03	5.15E-03	5.34E-03	5.27E-03	4.91E-03
<b>Un-Biased Statistics</b>							
Average Un-Biased	5.88E-03	6.16E-03	6.00E-03	6.00E-03	5.88E-03	5.94E-03	5.90E-03
Std Dev Un-Biased	1.30E-04	1.14E-04	7.07E-05	7.07E-05	1.30E-04	8.94E-05	1.41E-04
Ps99%/90% (+KTL) Un-Biased	6.49E-03	6.69E-03	6.33E-03	6.33E-03	6.49E-03	6.36E-03	6.56E-03
Ps99%/90% (-KTL) Un-Biased	5.27E-03	5.63E-03	5.67E-03	5.67E-03	5.27E-03	5.52E-03	5.24E-03
<b>Specification MAX</b>	<b>1.00E-02</b>	<b>1.00E-02</b>	<b>1.00E-02</b>	<b>1.00E-02</b>	<b>1.00E-02</b>	<b>1.00E-02</b>	<b>1.00E-02</b>
Status	PASS	PASS	PASS	PASS	PASS	PASS	PASS

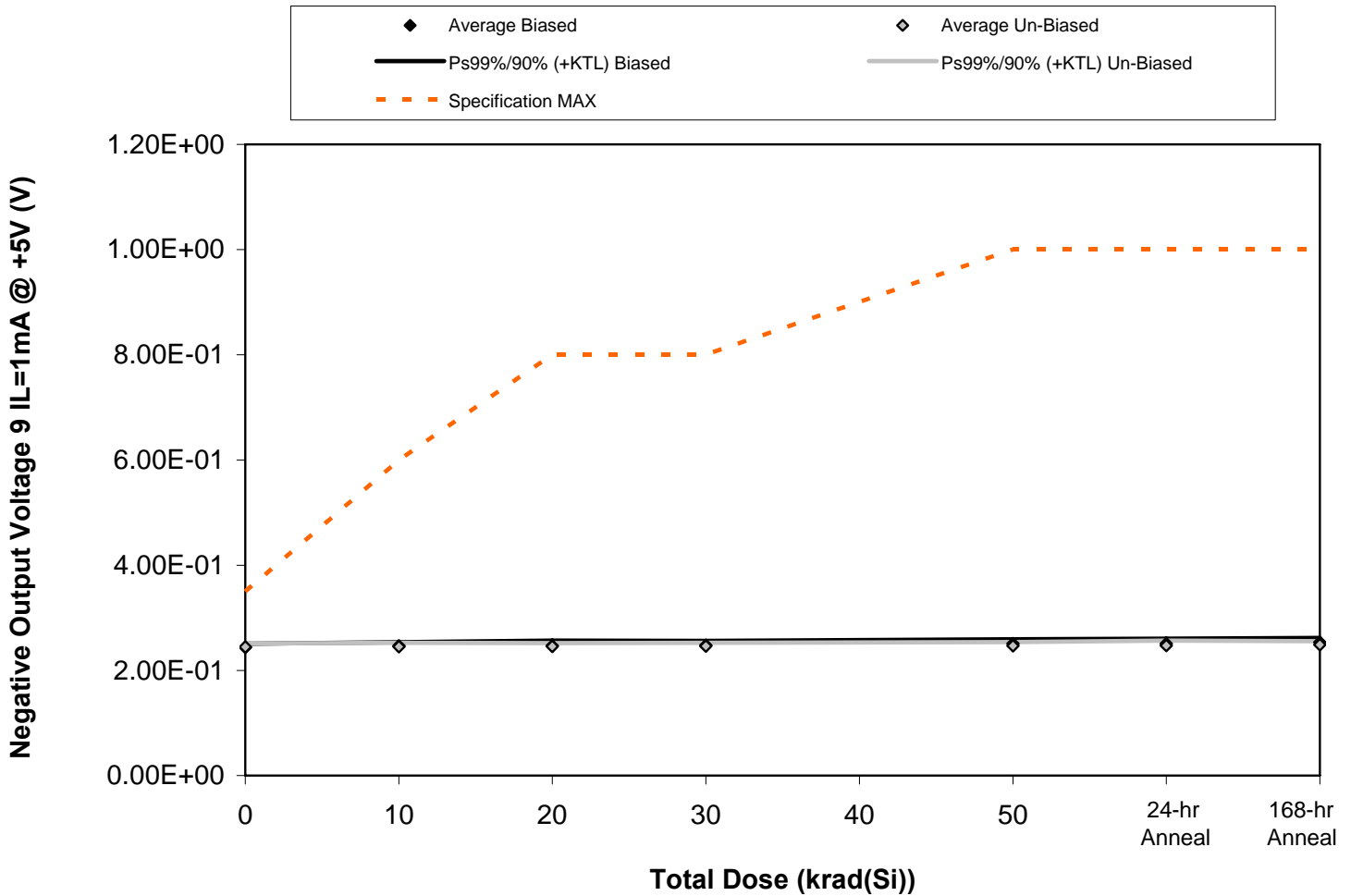

Figure 5.81. Plot of Negative Output Voltage 9 IL=1mA @ +5V (V) versus total dose. The data show no significant degradation with radiation. The solid diamonds are the average of measured data points from the biased sample (devices irradiated with an electrical bias) while the shaded diamonds are the average from the unbiased sample. The black lines show the effects on the data after application of the biased KTL statistics (solid and dashed lines) while the gray lines show the effects on the data after application of the unbiased KTL statistics (solid and dashed lines). The red dashed lines are the minimum and maximum specification values as defined in the datasheet and/or test plan.





Table 5.81. Raw data for Negative Output Voltage 9 IL=1mA @ +5V (V) versus total dose, including the statistical analysis, the specification and the status of the testing (pass/fail).

Negative Output Voltage 9 IL=1mA @ +5V (V)	Total Dose (krad(Si))					24-hr Anneal	168-hr Anneal
	0	10	20	30	50		
Device							
1027	2.44E-01	2.46E-01	2.48E-01	2.48E-01	2.51E-01	2.52E-01	2.53E-01
1029	2.41E-01	2.44E-01	2.43E-01	2.45E-01	2.48E-01	2.48E-01	2.51E-01
1030	2.44E-01	2.47E-01	2.47E-01	2.50E-01	2.53E-01	2.53E-01	2.56E-01
1031	2.44E-01	2.47E-01	2.47E-01	2.48E-01	2.50E-01	2.50E-01	2.53E-01
1032	2.45E-01	2.48E-01	2.48E-01	2.48E-01	2.51E-01	2.52E-01	2.54E-01
1033	2.46E-01	2.47E-01	2.47E-01	2.47E-01	2.49E-01	2.50E-01	2.51E-01
1034	2.45E-01	2.45E-01	2.46E-01	2.47E-01	2.47E-01	2.48E-01	2.49E-01
1035	2.45E-01	2.46E-01	2.46E-01	2.47E-01	2.47E-01	2.48E-01	2.49E-01
1036	2.42E-01	2.43E-01	2.44E-01	2.44E-01	2.45E-01	2.45E-01	2.47E-01
1038	2.44E-01	2.44E-01	2.44E-01	2.45E-01	2.46E-01	2.46E-01	2.48E-01
1039	2.40E-01	2.42E-01	2.42E-01	2.42E-01	2.40E-01	2.40E-01	2.41E-01
<b>Biased Statistics</b>							
Average Biased	2.44E-01	2.46E-01	2.47E-01	2.48E-01	2.51E-01	2.51E-01	2.53E-01
Std Dev Biased	1.52E-03	1.52E-03	2.07E-03	1.79E-03	1.82E-03	2.00E-03	1.82E-03
Ps99%/90% (+KTL) Biased	2.51E-01	2.53E-01	2.56E-01	2.56E-01	2.59E-01	2.60E-01	2.62E-01
Ps99%/90% (-KTL) Biased	2.37E-01	2.39E-01	2.37E-01	2.39E-01	2.42E-01	2.42E-01	2.45E-01
<b>Un-Biased Statistics</b>							
Average Un-Biased	2.44E-01	2.45E-01	2.45E-01	2.46E-01	2.47E-01	2.47E-01	2.49E-01
Std Dev Un-Biased	1.52E-03	1.58E-03	1.34E-03	1.41E-03	1.48E-03	1.95E-03	1.48E-03
Ps99%/90% (+KTL) Un-Biased	2.51E-01	2.52E-01	2.52E-01	2.53E-01	2.54E-01	2.56E-01	2.56E-01
Ps99%/90% (-KTL) Un-Biased	2.37E-01	2.38E-01	2.39E-01	2.39E-01	2.40E-01	2.38E-01	2.42E-01
<b>Specification MAX</b>	<b>3.50E-01</b>	<b>6.00E-01</b>	<b>8.00E-01</b>	<b>8.00E-01</b>	<b>1.00E+00</b>	<b>1.00E+00</b>	<b>1.00E+00</b>
Status	PASS	PASS	PASS	PASS	PASS	PASS	PASS

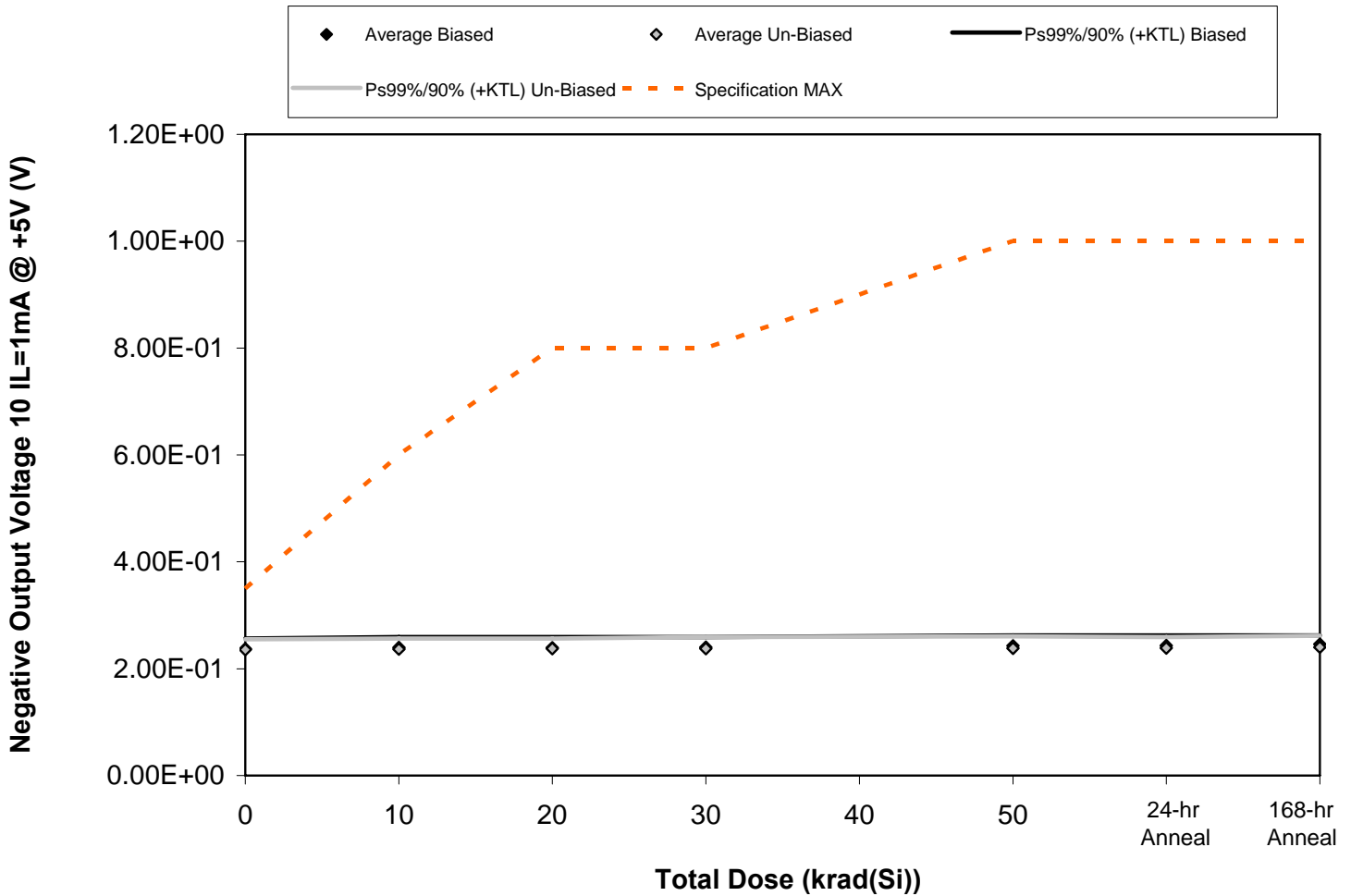

Figure 5.82. Plot of Negative Output Voltage 10 IL=1mA @ +5V (V) versus total dose. The data show no significant degradation with radiation. The solid diamonds are the average of measured data points from the biased sample (devices irradiated with an electrical bias) while the shaded diamonds are the average from the unbiased sample. The black lines show the effects on the data after application of the biased KTL statistics (solid and dashed lines) while the gray lines show the effects on the data after application of the unbiased KTL statistics (solid and dashed lines). The red dashed lines are the minimum and maximum specification values as defined in the datasheet and/or test plan.



Table 5.82. Raw data for Negative Output Voltage 10 IL=1mA @ +5V (V) versus total dose, including the statistical analysis, the specification and the status of the testing (pass/fail).

Negative Output Voltage 10 IL=1mA @ +5V (V)	Total Dose (krad(Si))					24-hr Anneal	168-hr Anneal
	0	10	20	30	50		
Device							
1027	2.40E-01	2.42E-01	2.42E-01	2.43E-01	2.45E-01	2.46E-01	2.48E-01
1029	2.36E-01	2.38E-01	2.37E-01	2.38E-01	2.41E-01	2.41E-01	2.44E-01
1030	2.30E-01	2.33E-01	2.33E-01	2.34E-01	2.36E-01	2.37E-01	2.40E-01
1031	2.39E-01	2.42E-01	2.42E-01	2.43E-01	2.45E-01	2.46E-01	2.48E-01
1032	2.40E-01	2.43E-01	2.43E-01	2.43E-01	2.46E-01	2.46E-01	2.48E-01
1033	2.37E-01	2.38E-01	2.39E-01	2.39E-01	2.40E-01	2.40E-01	2.42E-01
1034	2.32E-01	2.34E-01	2.34E-01	2.34E-01	2.35E-01	2.35E-01	2.36E-01
1035	2.31E-01	2.31E-01	2.32E-01	2.32E-01	2.32E-01	2.33E-01	2.34E-01
1036	2.40E-01	2.40E-01	2.41E-01	2.42E-01	2.42E-01	2.42E-01	2.44E-01
1038	2.39E-01	2.41E-01	2.41E-01	2.42E-01	2.43E-01	2.43E-01	2.44E-01
1039	2.34E-01	2.37E-01	2.36E-01	2.36E-01	2.34E-01	2.35E-01	2.36E-01
<b>Biased Statistics</b>							
Average Biased	2.37E-01	2.40E-01	2.39E-01	2.40E-01	2.43E-01	2.43E-01	2.46E-01
Std Dev Biased	4.24E-03	4.16E-03	4.28E-03	4.09E-03	4.16E-03	4.09E-03	3.58E-03
Ps99%/90% (+KTL) Biased	2.57E-01	2.59E-01	2.59E-01	2.59E-01	2.62E-01	2.62E-01	2.62E-01
Ps99%/90% (-KTL) Biased	2.17E-01	2.20E-01	2.19E-01	2.21E-01	2.23E-01	2.24E-01	2.29E-01
<b>Un-Biased Statistics</b>							
Average Un-Biased	2.36E-01	2.37E-01	2.37E-01	2.38E-01	2.38E-01	2.39E-01	2.40E-01
Std Dev Un-Biased	4.09E-03	4.21E-03	4.16E-03	4.60E-03	4.72E-03	4.39E-03	4.69E-03
Ps99%/90% (+KTL) Un-Biased	2.55E-01	2.56E-01	2.57E-01	2.59E-01	2.60E-01	2.59E-01	2.62E-01
Ps99%/90% (-KTL) Un-Biased	2.17E-01	2.17E-01	2.18E-01	2.16E-01	2.16E-01	2.18E-01	2.18E-01
<b>Specification MAX</b>	<b>3.50E-01</b>	<b>6.00E-01</b>	<b>8.00E-01</b>	<b>8.00E-01</b>	<b>1.00E+00</b>	<b>1.00E+00</b>	<b>1.00E+00</b>
Status	PASS	PASS	PASS	PASS	PASS	PASS	PASS

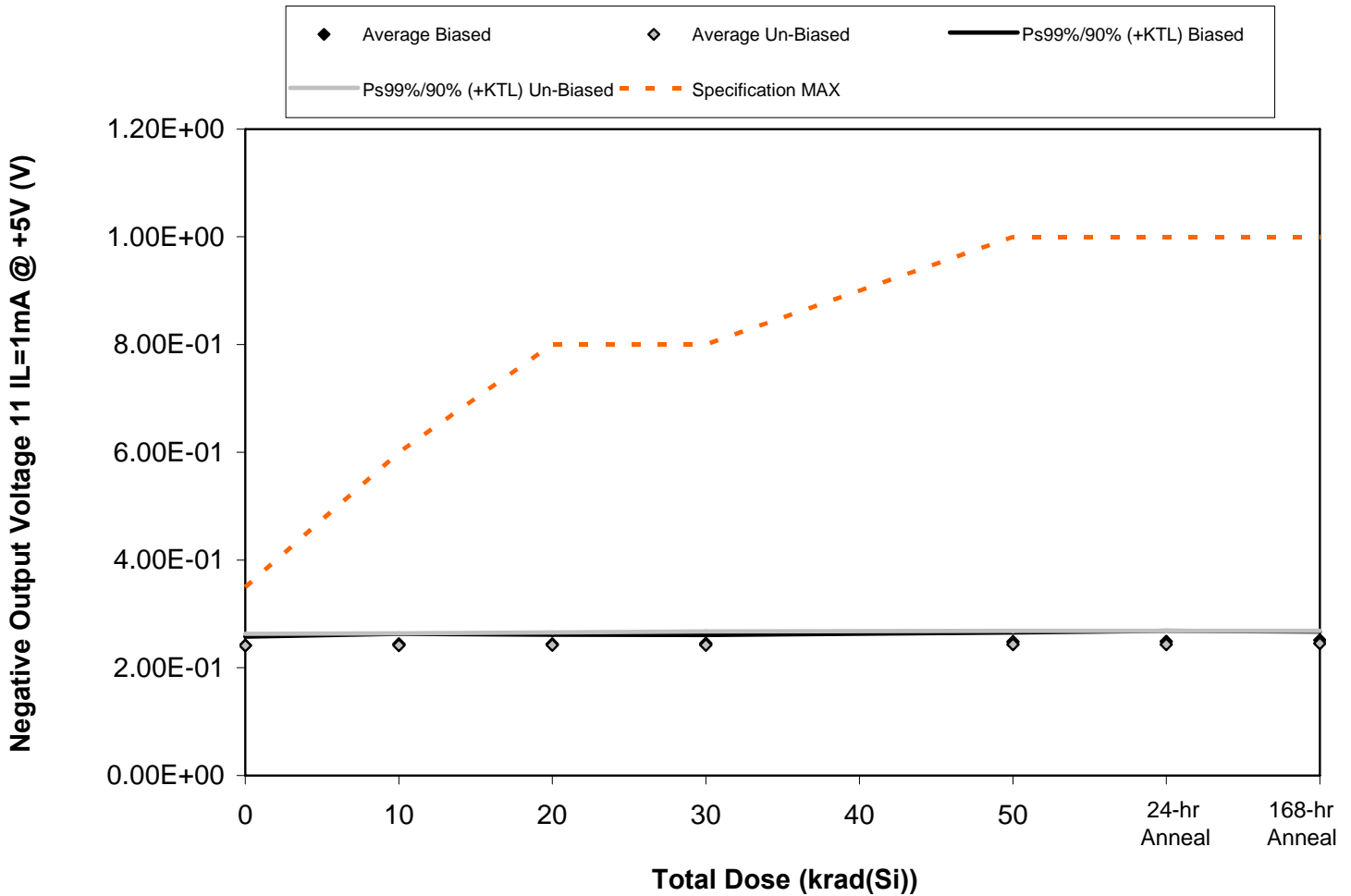

Figure 5.83. Plot of Negative Output Voltage 11 IL=1mA @ +5V (V) versus total dose. The data show no significant degradation with radiation. The solid diamonds are the average of measured data points from the biased sample (devices irradiated with an electrical bias) while the shaded diamonds are the average from the unbiased sample. The black lines show the effects on the data after application of the biased KTL statistics (solid and dashed lines) while the gray lines show the effects on the data after application of the unbiased KTL statistics (solid and dashed lines). The red dashed lines are the minimum and maximum specification values as defined in the datasheet and/or test plan.



Table 5.83. Raw data for Negative Output Voltage 11 IL=1mA @ +5V (V) versus total dose, including the statistical analysis, the specification and the status of the testing (pass/fail).

Negative Output Voltage 11 IL=1mA @ +5V (V)	Total Dose (krad(Si))					24-hr Anneal	168-hr Anneal
	0	10	20	30	50		
Device							
1027	2.44E-01	2.47E-01	2.47E-01	2.48E-01	2.51E-01	2.52E-01	2.54E-01
1029	2.40E-01	2.42E-01	2.42E-01	2.43E-01	2.46E-01	2.46E-01	2.49E-01
1030	2.36E-01	2.38E-01	2.39E-01	2.41E-01	2.43E-01	2.43E-01	2.47E-01
1031	2.44E-01	2.47E-01	2.47E-01	2.48E-01	2.51E-01	2.52E-01	2.54E-01
1032	2.44E-01	2.47E-01	2.47E-01	2.48E-01	2.51E-01	2.52E-01	2.54E-01
1033	2.43E-01	2.43E-01	2.45E-01	2.45E-01	2.46E-01	2.46E-01	2.48E-01
1034	2.36E-01	2.36E-01	2.37E-01	2.36E-01	2.37E-01	2.37E-01	2.39E-01
1035	2.37E-01	2.37E-01	2.37E-01	2.37E-01	2.38E-01	2.38E-01	2.41E-01
1036	2.46E-01	2.46E-01	2.47E-01	2.47E-01	2.48E-01	2.48E-01	2.50E-01
1038	2.45E-01	2.46E-01	2.46E-01	2.47E-01	2.48E-01	2.48E-01	2.49E-01
1039	2.39E-01	2.41E-01	2.41E-01	2.41E-01	2.38E-01	2.38E-01	2.40E-01
<b>Biased Statistics</b>							
Average Biased	2.42E-01	2.44E-01	2.44E-01	2.46E-01	2.48E-01	2.49E-01	2.52E-01
Std Dev Biased	3.58E-03	4.09E-03	3.71E-03	3.36E-03	3.71E-03	4.24E-03	3.36E-03
Ps99%/90% (+KTL) Biased	2.58E-01	2.63E-01	2.62E-01	2.61E-01	2.66E-01	2.69E-01	2.67E-01
Ps99%/90% (-KTL) Biased	2.25E-01	2.25E-01	2.27E-01	2.30E-01	2.31E-01	2.29E-01	2.36E-01
<b>Un-Biased Statistics</b>							
Average Un-Biased	2.41E-01	2.42E-01	2.42E-01	2.42E-01	2.43E-01	2.43E-01	2.45E-01
Std Dev Un-Biased	4.62E-03	4.83E-03	4.98E-03	5.46E-03	5.46E-03	5.46E-03	5.03E-03
Ps99%/90% (+KTL) Un-Biased	2.63E-01	2.64E-01	2.66E-01	2.68E-01	2.69E-01	2.69E-01	2.69E-01
Ps99%/90% (-KTL) Un-Biased	2.20E-01	2.19E-01	2.19E-01	2.17E-01	2.18E-01	2.18E-01	2.22E-01
<b>Specification MAX</b>	<b>3.50E-01</b>	<b>6.00E-01</b>	<b>8.00E-01</b>	<b>8.00E-01</b>	<b>1.00E+00</b>	<b>1.00E+00</b>	<b>1.00E+00</b>
Status	PASS	PASS	PASS	PASS	PASS	PASS	PASS

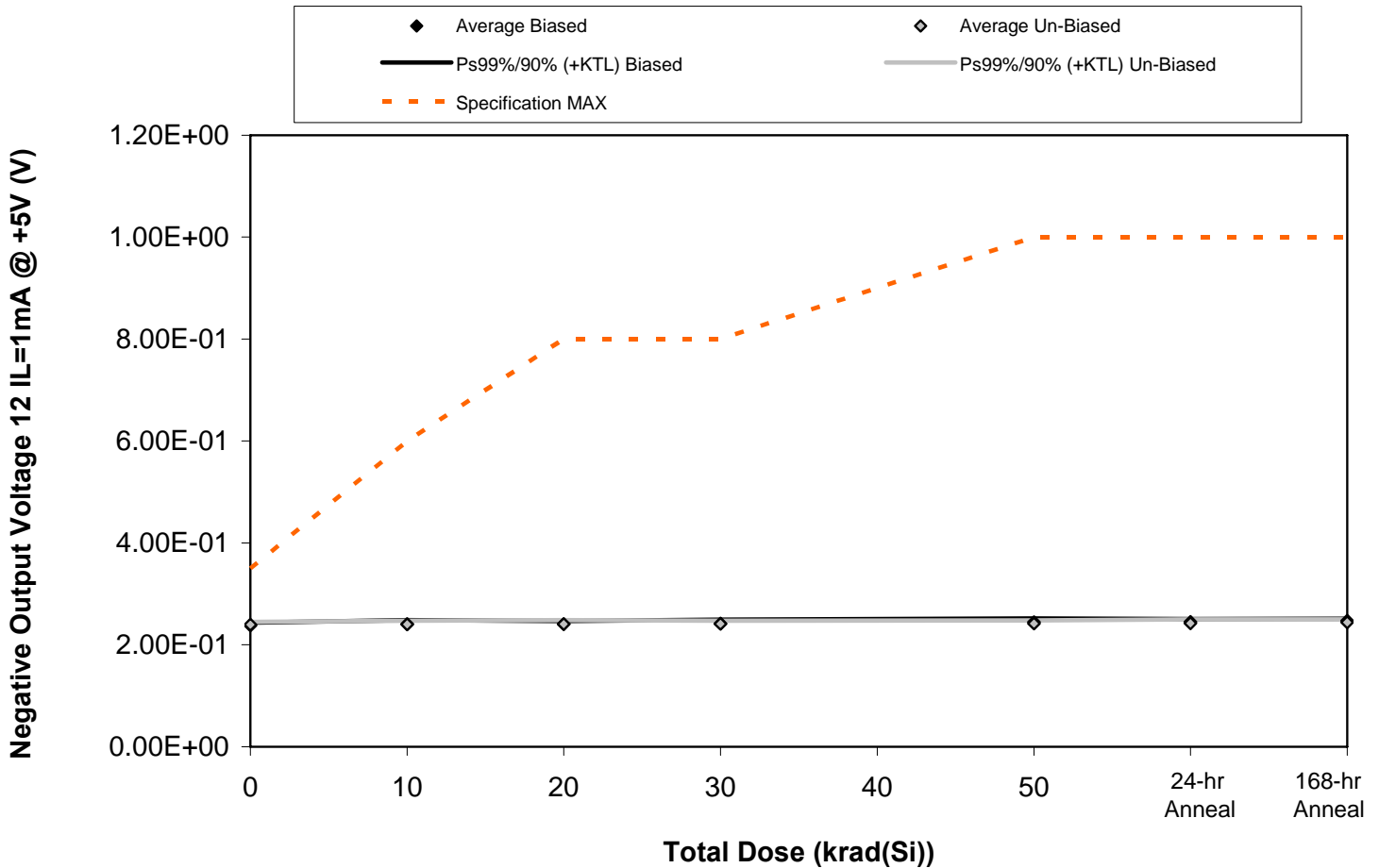

Figure 5.84. Plot of Negative Output Voltage 12 IL=1mA @ +5V (V) versus total dose. The data show no significant degradation with radiation. The solid diamonds are the average of measured data points from the biased sample (devices irradiated with an electrical bias) while the shaded diamonds are the average from the unbiased sample. The black lines show the effects on the data after application of the biased KTL statistics (solid and dashed lines) while the gray lines show the effects on the data after application of the unbiased KTL statistics (solid and dashed lines). The red dashed lines are the minimum and maximum specification values as defined in the datasheet and/or test plan.



Table 5.84. Raw data for Negative Output Voltage 12 IL=1mA @ +5V (V) versus total dose, including the statistical analysis, the specification and the status of the testing (pass/fail).

Negative Output Voltage 12 IL=1mA @ +5V (V)	Total Dose (krad(Si))					24-hr Anneal	168-hr Anneal
	0	10	20	30	50		
Device							
1027	2.39E-01	2.41E-01	2.42E-01	2.43E-01	2.45E-01	2.46E-01	2.47E-01
1029	2.36E-01	2.38E-01	2.39E-01	2.39E-01	2.42E-01	2.43E-01	2.46E-01
1030	2.39E-01	2.42E-01	2.41E-01	2.43E-01	2.46E-01	2.46E-01	2.48E-01
1031	2.38E-01	2.41E-01	2.41E-01	2.42E-01	2.44E-01	2.45E-01	2.47E-01
1032	2.38E-01	2.42E-01	2.42E-01	2.42E-01	2.45E-01	2.45E-01	2.48E-01
1033	2.41E-01	2.42E-01	2.42E-01	2.42E-01	2.43E-01	2.44E-01	2.45E-01
1034	2.40E-01	2.41E-01	2.42E-01	2.42E-01	2.43E-01	2.43E-01	2.45E-01
1035	2.40E-01	2.41E-01	2.41E-01	2.42E-01	2.42E-01	2.43E-01	2.44E-01
1036	2.38E-01	2.38E-01	2.38E-01	2.39E-01	2.40E-01	2.40E-01	2.42E-01
1038	2.39E-01	2.40E-01	2.40E-01	2.41E-01	2.41E-01	2.41E-01	2.43E-01
1039	2.35E-01	2.38E-01	2.38E-01	2.37E-01	2.35E-01	2.36E-01	2.37E-01
<b>Biased Statistics</b>							
Average Biased	2.38E-01	2.41E-01	2.41E-01	2.42E-01	2.44E-01	2.45E-01	2.47E-01
Std Dev Biased	1.22E-03	1.64E-03	1.22E-03	1.64E-03	1.52E-03	1.22E-03	8.37E-04
Ps99%/90% (+KTL) Biased	2.44E-01	2.48E-01	2.47E-01	2.49E-01	2.51E-01	2.51E-01	2.51E-01
Ps99%/90% (-KTL) Biased	2.32E-01	2.33E-01	2.35E-01	2.34E-01	2.37E-01	2.39E-01	2.43E-01
<b>Un-Biased Statistics</b>							
Average Un-Biased	2.40E-01	2.40E-01	2.41E-01	2.41E-01	2.42E-01	2.42E-01	2.44E-01
Std Dev Un-Biased	1.14E-03	1.52E-03	1.67E-03	1.30E-03	1.30E-03	1.64E-03	1.30E-03
Ps99%/90% (+KTL) Un-Biased	2.45E-01	2.47E-01	2.48E-01	2.47E-01	2.48E-01	2.50E-01	2.50E-01
Ps99%/90% (-KTL) Un-Biased	2.34E-01	2.33E-01	2.33E-01	2.35E-01	2.36E-01	2.35E-01	2.38E-01
<b>Specification MAX</b>	<b>3.50E-01</b>	<b>6.00E-01</b>	<b>8.00E-01</b>	<b>8.00E-01</b>	<b>1.00E+00</b>	<b>1.00E+00</b>	<b>1.00E+00</b>
Status	PASS	PASS	PASS	PASS	PASS	PASS	PASS



## **6.0. Summary / Conclusions**

The low dose rate total ionizing dose testing described in this final report was performed using the facilities at Radiation Assured Devices' Longmire Laboratories in Colorado Springs, CO. For the low dose rate ELDRS testing described in this report, the devices were placed approximately 2-meters from the Co-60 rods to achieve the required 10mrad(Si)/s dose rate. Samples of the RH1014MW quad operational amplifier described in this report were irradiated biased with a split 15V supply and unbiased (all leads tied to ground). The devices were irradiated to a maximum total ionizing dose level of 50krad(Si) with a pre-rad baseline reading as well as incremental readings at 10, 20, and 30krad(Si). Electrical testing occurred within one hour following the end of each irradiation segment. For intermediate irradiations, the units were tested and returned to total dose exposure within two hours from the end of the previous radiation increment. In addition, all units-under-test received a 24hr room temperature and 168hr 100°C anneal, using the same bias conditions as the radiation exposure.

The parametric data was obtained as "read and record" and all the raw data plus an attributes summary were presented in this report. The attributes data contains the average, standard deviation and the average with the KTL values applied. The KTL value used was 2.742 per MIL HDBK 814 using one-sided tolerance limits of 99/90 and a 5-piece sample size. Note that the following criteria was used to determine the outcome of the testing: following the radiation exposure each parameter had to pass the specification value and the average value for the ten-piece sample must pass the specification value when the KTL limits are applied. If these conditions were not both satisfied following the radiation exposure, then the lot would be logged as an RLAT failure.

Based on these criteria, the RH1014MW quad operational amplifier discussed in this report passed the ELDRS test to the highest level tested of 50krad(Si) without any appreciable degradation to most of the measured parameters. Where radiation induced degradation was observed the degradation was not sufficient to cause the parameter to exceed the specification value.





## Appendix A: TID Bias Connections

*(Extracted from LINEAR TECHNOLOGY CORPORATION RH1014M Quad Precision Operational Amplifier Datasheet)*

### Biased Samples:

Pin	Function	Bias
1	OUT A	To Pin 2 Via 10k $\Omega$ Resistor
2	-IN A	To Pin 1 Via 10k $\Omega$ Resistor
3	+IN A	8V Via 10k $\Omega$ Resistor
4	V+	+15V Decoupled to GND W/ 0.1 $\mu$ F
5	+IN B	8V Via 10k $\Omega$ Resistor
6	-IN B	To Pin 7 Via 10k $\Omega$ Resistor
7	OUT B	To Pin 6 Via 10k $\Omega$ Resistor
8	OUT C	To Pin 9 Via 10k $\Omega$ Resistor
9	-IN C	To Pin 8 Via 10k $\Omega$ Resistor
10	+IN C	8V Via 10k $\Omega$ Resistor
11	V-	-15V Decoupled to GND W/ 0.1 $\mu$ F
12	+IN D	8V Via 10k $\Omega$ Resistor
13	-IN D	To Pin 14 Via 10k $\Omega$ Resistor
14	OUT D	To Pin 13 Via 10k $\Omega$ Resistor



**Unbiased Samples (All Pins Tied to Ground):**

Pin	Function	Bias
1	OUT A	GND
2	-IN A	GND
3	+IN A	GND
4	V+	GND
5	+IN B	GND
6	-IN B	GND
7	OUT B	GND
8	OUT C	GND
9	-IN C	GND
10	+IN C	GND
11	V-	GND
12	+IN D	GND
13	-IN D	GND
14	OUT D	GND

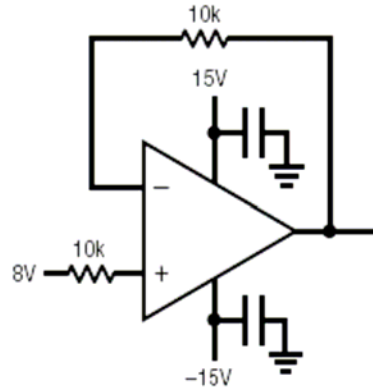

Figure A.1. Irradiation bias drawing for the units to be irradiated under electrical bias. This figure was extracted from the LINEAR TECHNOLOGY CORPORATION RH1014M Quad Precision Operational Amplifier Datasheet.

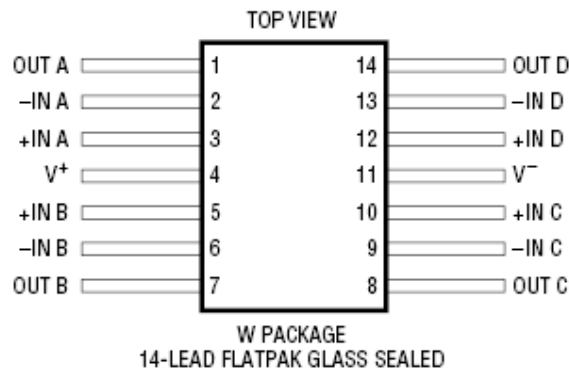

Figure A.2. Package drawing (for reference only). This figure was extracted from the LINEAR TECHNOLOGY CORPORATION RH1014M Quad Precision Operational Amplifier Datasheet.



**Appendix B: Photograph of device-under-test to show part markings**





## **Appendix C: Electrical Test Parameters and Conditions**

All electrical tests for this device are performed on Radiation Assured Device's LTS2020 Test System. The LTS2020 Test System is a programmable parametric tester that provides parameter measurements for a variety of digital, analog and mixed signal products including voltage regulators, voltage comparators, D to A and A to D converters. The LTS2020 Test System achieves accuracy and sensitivity through the use of software self-calibration and an internal relay matrix with separate family boards and custom personality adapter boards. The tester uses this relay matrix to connect the required test circuits, select the appropriate voltage / current sources and establish the needed measurement loops for all the tests performed. The measured parameters and test conditions are shown in Table C.1.

A listing of the measurement precision/resolution for each parameter is shown in Table C.2. The precision/resolution values were obtained either from test data or from the DAC resolution of the LTS-2020. To generate the precision/resolution shown in Table C.2, one of the units-under-test was tested repetitively (a total of 10-times with re-insertion between tests) to obtain the average test value and standard deviation. Using this test data MIL-HDBK-814 90/90 KTL statistics were applied to the measured standard deviation to generate the final measurement range. This value encompasses the precision/resolution of all aspects of the test system, including the LTS2020 mainframe, family board, socket assembly and DUT board as well as insertion error. In some cases, the measurement resolution is limited by the internal DACs, which results in a measured standard deviation of zero. In these instances the precision/resolution will be reported back as the LSB of the DAC.

Note that the testing and statistics used in this document are based on an "analysis of variables" technique, which relies on small sample sizes to qualify much larger lot sizes (see MIL-HDBK-814, p. 91 for a discussion of statistical treatments). Unfortunately, not all measured parameters are well suited to this approach due to inherent large variations. One such parameter is pre-irradiation Open Loop Gain, where the device exhibits extreme sensitivity to input conditions, resulting in a very large standard deviation and a statistical error often greater than the measured value. If necessary, larger samples sizes could be used to qualify these parameters using an "attributes" approach.



Table C.1. Measured parameters and test conditions for the RH1014MW. Unless otherwise noted the conditions were selected to match the post-irradiation specifications. See LINEAR TECHNOLOGY CORPORATION RH1014M Quad Precision Operational Amplifier Datasheet for the post irradiation test conditions and specifications.

TEST NUMBER	TEST DESCRIPTION	TEST CONDITIONS
1	Positive Supply Current (ICC+)	$V_S = \pm 15V$
2	Negative Supply Current (IEE-)	$V_S = \pm 15V$
3	Input Offset Voltage ( $V_{OS1} - V_{OS4}$ )	$V_S = \pm 15V$
4	Input Offset Current ( $I_{OS1} - I_{OS4}$ )	$V_S = \pm 15V$
5	+ Input Bias Current ( $I_{B+1} - I_{B+4}$ )	$V_S = \pm 15V$
6	- Input Bias Current ( $I_{B-1} - I_{B-4}$ )	$V_S = \pm 15V$
7	Common Mode Rejection Ratio (CMRR1-CMRR4)	$V_{CM} = 13.5V, -15V$
8	Power Supply Rejection Ratio (PSRR1-PSRR4)	$V_S = \pm 2V$ to $\pm 18V$
9	Large Signal Voltage Gain ( $A_{VOL9} - A_{VOL12}$ )	$V_S = \pm 15V, V_O = \pm 10V, R_L = 10k\Omega$
10	Positive Output Voltage Swing ( $V_{OUT+1} - V_{OUT+4}$ )	$V_S = \pm 15V, R_L = 2k\Omega$
11	Negative Output Voltage Swing ( $V_{OUT-1} - V_{OUT-4}$ )	$V_S = \pm 15V, R_L = 2k\Omega$
12	Positive Slew Rate (SlewRate+1-SlewRate+4)	$V_S = \pm 15V, R_L = 10k\Omega$
13	Negative Slew Rate (SlewRate-1-SlewRate-4)	$V_S = \pm 15V, R_L = 10k\Omega$



14	Positive Supply Current ( $I_{CC+2}$ )	$V_S=+5V$ , $V_{OUT}=1.4V$ Using Servo Loop
15	Negative Supply Current ( $I_{EE-2}$ )	$V_S=+5V$ , $V_{OUT}=1.4V$ Using Servo Loop
16	Input Offset Voltage ( $V_{OS5}-V_{OS8}$ )	$V_S=+5V$
17	Input Offset Current ( $I_{OS5}-I_{OS8}$ )	$V_S=+5V$
18	+ Input Bias Current ( $I_{B+5}-I_{B+8}$ )	$V_S=+5V$
19	- Input Bias Current ( $I_{B-5}-I_{B-8}$ )	$V_S=+5V$
20	Positive Output Voltage Swing ( $V_{OUT+5}-V_{OUT+8}$ )	$V_S=+5V$ , No Load
21	Positive Output Voltage Swing ( $V_{OUT+9}-V_{OUT+12}$ )	$V_S=+5V$ , $R_L=600\Omega$
22	Negative Output Voltage Swing ( $V_{OUT-5}-V_{OUT-8}$ )	$V_S=+5V$ , No Load
23	Negative Output Voltage Swing ( $V_{OUT-9}-V_{OUT-12}$ )	$V_S=+5V$ , $R_L=600\Omega$
24	Negative Output Voltage Swing ( $V_{OUT-13}-V_{OUT-16}$ )	$V_S=+5V$ , $I_{SINK}=1mA$



Table C.2. Measured parameters, pre-irradiation specifications and measurement resolution for the RH1014MW.

<b>Measured Parameter</b>	<b>Pre-Irradiation Specification</b>	<b>Measurement Resolution/Precision</b>
Positive Supply Current (ICC+)	2.2mA	±4.8E-06A
Negative Supply Current (IEE-)	-2.2mA	±3.6E-06A
Input Offset Voltage (V <sub>OS1</sub> -V <sub>OS4</sub> )	±0.3mV	± 1.27E-06V
Input Offset Current (I <sub>OS1</sub> -I <sub>OS4</sub> )	±10nA	± 2.64E-11A
+ Input Bias Current (I <sub>B+1</sub> -I <sub>B+4</sub> )	±30nA	±5.02E-11A
- Input Bias Current (I <sub>B-1</sub> -I <sub>B-4</sub> )	±30nA	± 3.95E-11A
Common Mode Rejection Ratio (CMRR1-CMRR4)	97dB	±1.89dB
Power Supply Rejection Ratio (PSRR1-PSRR4)	100dB	±3.35dB
Large Signal Voltage Gain (A <sub>VOL9</sub> -A <sub>VOL12</sub> )	1200V/mV	±1.70E+04V/mV
Positive Output Voltage Swing (V <sub>OUT+1</sub> -V <sub>OUT+4</sub> )	12.5V	±1.46E-03V
Negative Output Voltage Swing (V <sub>OUT-1</sub> -V <sub>OUT-4</sub> )	-12.5V	±1.63E-03V
Positive Slew Rate (SlewRate+1-SlewRate+4)	0.2V/μs	±1.9E-02V/μs
Negative Slew Rate (SlewRate-1-SlewRate-4)	-0.2V/μs	±2.49E-02V/μs





Positive Supply Current (ICC+2)	2.0mA	$\pm 4.8E-06A$
Negative Supply Current (IEE-2)	-2.0mA	$\pm 3.6E-06A$
Input Offset Voltage (VOS5-VOS8)	$\pm 0.45mV$	$\pm 1.4E-06V$
Input Offset Current (IOS5-IOS8)	$\pm 10nA$	$\pm 3.2E-11A$
+ Input Bias Current (IB+5-IB+8)	$\pm 50nA$	$\pm 9.7E-11A$
- Input Bias Current (IB-5-IB-8)	$\pm 50nA$	$\pm 5.6E-11A$
Positive Output Voltage Swing (VOUT+5-VOUT+8)	4.0V	$\pm 1.5E-03V$
Positive Output Voltage Swing (VOUT+9-VOUT+12)	3.4V	$\pm 1.2E-03V$
Negative Output Voltage Swing (VOUT-5-VOUT-8)	25mV	$\pm 1.2E-03V$
Negative Output Voltage Swing (VOUT-9-VOUT-12)	10mV	$\pm 1.6E-03V$
Negative Output Voltage Swing (VOUT-13-VOUT-16)	350mV	$\pm 1.5E-03V$



## Appendix D: List of Figures

- 5.1 Positive Supply Current @ +/-15V (A)
- 5.2 Negative Supply Current @ +/-15V (A)
- 5.3 Offset Voltage 1 @ +/-15V (V)
- 5.4 Offset Voltage 2 @ +/-15V (V)
- 5.5 Offset Voltage 3 @ +/-15V (V)
- 5.6 Offset Voltage 4 @ +/-15V (V)
- 5.7 Offset Current 1 @ +/-15V (A)
- 5.8 Offset Current 2 @ +/-15V (A)
- 5.9 Offset Current 3 @ +/-15V (A)
- 5.10 Offset Current 4 @ +/-15V (A)
- 5.11 Positive Bias Current 1 @ +/-15V (A)
- 5.12 Positive Bias Current 2 @ +/-15V (A)
- 5.13 Positive Bias Current 3 @ +/-15V (A)
- 5.14 Positive Bias Current 4 @ +/-15V (A)
- 5.15 Negative Bias Current 1 @ +/-15V (A)
- 5.16 Negative Bias Current 2 @ +/-15V (A)
- 5.17 Negative Bias Current 3 @ +/-15V (A)
- 5.18 Negative Bias Current 4 @ +/-15V (A)
- 5.19 Common Mode Rejection Ratio 1 (dB)
- 5.20 Common Mode Rejection Ratio 2 (dB)
- 5.21 Common Mode Rejection Ratio 3 (dB)
- 5.22 Common Mode Rejection Ratio 4 (dB)
- 5.23 Power Supply Rejection Ratio 1 (dB)
- 5.24 Power Supply Rejection Ratio 2 (dB)
- 5.25 Power Supply Rejection Ratio 3 (dB)
- 5.26 Power Supply Rejection Ratio 4 (dB)
- 5.27 Open Loop Gain 9 RL=10k VO=+/-10V (V/mV)
- 5.28 Open Loop Gain 10 RL=10k VO=+/-10V (V/mV)
- 5.29 Open Loop Gain 11 RL=10k VO=+/-10V (V/mV)
- 5.30 Open Loop Gain 12 RL=10k VO=+/-10V (V/mV)
- 5.31 Positive Output Voltage 1 @ +/-15V (V)
- 5.32 Positive Output Voltage 2 @ +/-15V (V)
- 5.33 Positive Output Voltage 3 @ +/-15V (V)
- 5.34 Positive Output Voltage 4 @ +/-15V (V)
- 5.35 Negative Output Voltage 1 @ +/-15V (V)
- 5.36 Negative Output Voltage 2 @ +/-15V (V)
- 5.37 Negative Output Voltage 3 @ +/-15V (V)
- 5.38 Negative Output Voltage 4 @ +/-15V (V)
- 5.39 Positive Slew Rate 1 @ +/-15V (V/us)



- 5.40 Positive Slew Rate 2 @ +/-15V (V/us)
- 5.41 Positive Slew Rate 3 @ +/-15V (V/us)
- 5.42 Positive Slew Rate 4 @ +/-15V (V/us)
- 5.43 Negative Slew Rate 1 @ +/-15V (V/us)
- 5.44 Negative Slew Rate 2 @ +/-15V (V/us)
- 5.45 Negative Slew Rate 3 @ +/-15V (V/us)
- 5.46 Negative Slew Rate 4 @ +/-15V (V/us)
- 5.47 Positive Supply Current @ +5V (A)
- 5.48 Negative Supply Current @ +5V (A)
- 5.49 Offset Voltage 1 @ +5V (V)
- 5.50 Offset Voltage 2 @ +5V (V)
- 5.51 Offset Voltage 3 @ +5V (V)
- 5.52 Offset Voltage 4 @ +5V (V)
- 5.53 Offset Current 1 @ +5V (A)
- 5.54 Offset Current 2 @ +5V (A)
- 5.55 Offset Current 3 @ +5V (A)
- 5.56 Offset Current 4 @ +5V (A)
- 5.57 Positive Bias Current 1 @ +5V (A)
- 5.58 Positive Bias Current 2 @ +5V (A)
- 5.59 Positive Bias Current 3 @ +5V (A)
- 5.60 Positive Bias Current 4 @ +5V (A)
- 5.61 Negative Bias Current 1 @ +5V (A)
- 5.62 Negative Bias Current 2 @ +5V (A)
- 5.63 Negative Bias Current 3 @ +5V (A)
- 5.64 Negative Bias Current 4 @ +5V (A)
- 5.65 Positive Output Voltage 1 RL=open @ +5V (V)
- 5.66 Positive Output Voltage 2 RL=open @ +5V (V)
- 5.67 Positive Output Voltage 3 RL=open @ +5V (V)
- 5.68 Positive Output Voltage 4 RL=open @ +5V (V)
- 5.69 Positive Output Voltage 5 RL=600 @ +5V (V)
- 5.70 Positive Output Voltage 6 RL=600 @ +5V (V)
- 5.71 Positive Output Voltage 7 RL=600 @ +5V (V)
- 5.72 Positive Output Voltage 8 RL=600 @ +5V (V)
- 5.73 Negative Output Voltage 1 RL=open @ +5V (V)
- 5.74 Negative Output Voltage 2 RL=open @ +5V (V)
- 5.75 Negative Output Voltage 3 RL=open @ +5V (V)
- 5.76 Negative Output Voltage 4 RL=open @ +5V (V)
- 5.77 Negative Output Voltage 5 RL=600 @ +5V (V)
- 5.78 Negative Output Voltage 6 RL=600 @ +5V (V)
- 5.79 Negative Output Voltage 7 RL=600 @ +5V (V)
- 5.80 Negative Output Voltage 8 RL=600 @ +5V (V)



**ELDRS Report  
08-199 090408 R1.2**

**Radiation Assured Devices  
5017 N. 30th Street  
Colorado Springs, CO 80919  
(719) 531-0800**

- 5.81 Negative Output Voltage 9 IL=1mA @ +5V (V)
- 5.82 Negative Output Voltage 10 IL=1mA @ +5V (V)
- 5.83 Negative Output Voltage 11 IL=1mA @ +5V (V)
- 5.84 Negative Output Voltage 12 IL=1mA @ +5V (V)

**An ISO 9001:2000 Certified Company**