

RADIATION TEST REPORT

PRODUCT:	AD8041SQMLR
DATE CODE:	0919
GAMMA:	0, 100k
GAMMA SOURCE:	Co60
DOSE RATE:	166 Rad(si)/s
FACILITIES:	University of Massachusetts @ Lowell
TESTED:	8/6/09

The RADTESTSM DATA SERVICE is a compilation of radiation test results on Analog Devices' Space grade products. It is designed to assist customers in selecting the right product for applications where radiation is a consideration. Many products manufactured by Analog Devices, Inc. have been shown to be radiation tolerant to most tactical radiation environments. Analog Devices, Inc. does not make any claim to maintain or guarantee these levels of radiation tolerance without lot qualification test.

It is the responsibility of the Procuring Activity to screen products from Analog Devices, Inc. for compliance to Nuclear Hardness Critical Items (HCI) specifications.

WARNING:

Analog Devices, Inc. does not recommend use of this data to qualify other product grades or process levels. Analog Devices, Inc. is not responsible and has no liability for any consequences, and all applicable Warranties are null and void if any Analog product is modified in any way or used outside of normal environmental and operating conditions, including the parameters specified in the corresponding data sheet. Analog Devices, Inc. does not guarantee that wafer manufacturing is the same for all process levels.



T# 1.0	ISY VS=±2.5V		mA
SN	Initial	100K	
2	-5.28336	-5.28758	
3	-5.26097	-5.30997	
4	-5.2098	-5.28439	
5	-5.26417	-5.42832	
6	-5.30575	-5.34836	
min	-5.30575	-5.42832	
max	-5.20980	-5.28439	
stdev	0.03929	0.06281	
average	-5.26017	-5.34276	
+3S	-5.14230	-5.15434	
-3S	-5.37805	-5.53118	

T# 3.0	Vos VS=-2.5V		mV
SN	Initial	100K	
2	-3.64057	-3.65939	
3	-3.75983	-3.77237	
4	-0.37661	-0.45821	
5	-4.06112	-4.05483	
6	-3.56525	-3.61545	
min	-4.06112	-4.05483	
max	-0.37661	-0.45821	
stdev	1.72152	1.68782	
average	-2.94070	-2.97522	
+3S	2.22387	2.08825	
-3S	-8.10527	-8.03868	

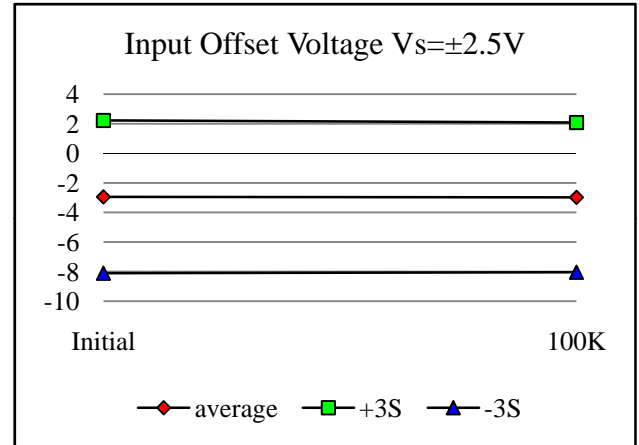
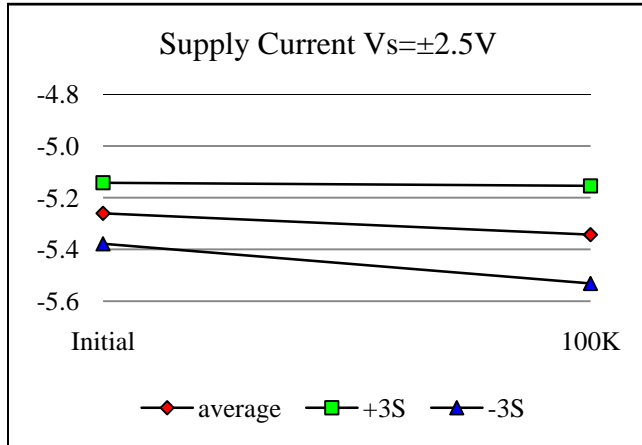

T# 5	+Vout RI=1k Ohm		V
SN	Initial	100K	
2	2.30833	2.30751	
3	2.30193	2.30111	
4	2.43571	2.43361	
5	2.2872	2.28703	
6	2.31217	2.30815	
min	2.28720	2.28703	
max	2.43571	2.43361	
stdev	0.06841	0.06799	
average	2.33425	2.33248	
+3S	2.53948	2.53645	
-3S	2.12902	2.12850	

T# 6	-Vout RI=1k Ohm		V
SN	Initial	100K	
2	-2.44667	-2.4462	
3	-2.44731	-2.44364	
4	-2.44283	-2.43916	
5	-2.44795	-2.44044	
6	-2.44667	-2.44364	
min	-2.44795	-2.44364	
max	-2.44283	-2.43916	
stdev	0.00230	0.00228	
average	-2.44619	-2.44172	
+3S	-2.43929	-2.43489	
-3S	-2.45309	-2.44855	

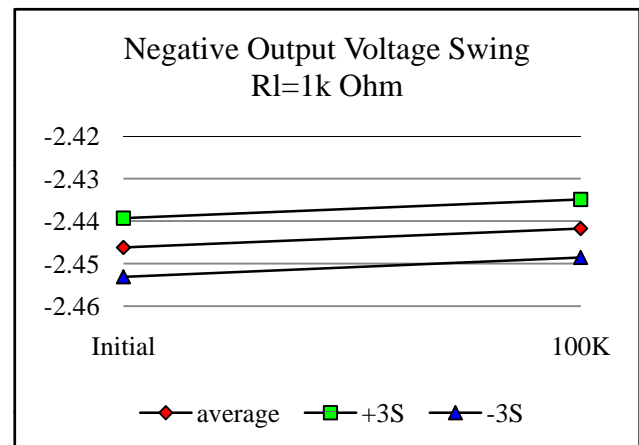
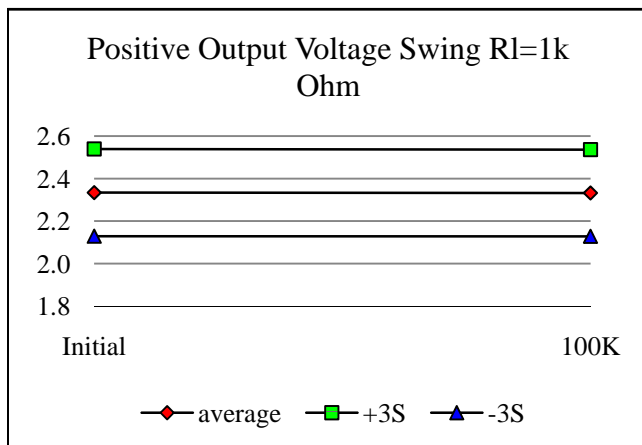

T# 7	+Vout RI=50 Ohm		V
SN	Initial	100K	
2	2.15502	2.14589	
3	2.15246	2.14909	
4	2.1627	2.16765	
5	2.1627	2.15101	
6	2.13838	2.14333	
min	2.13838	2.14333	
max	2.16270	2.16765	
stdev	0.01151	0.01044	
average	2.15406	2.15277	
+3S	2.18860	2.18410	
-3S	2.11952	2.12144	

T# 8	-Vout RI=50 Ohm		V
SN	Initial	100K	
2	-2.28953	-2.27561	
3	-2.28633	-2.28522	
4	-2.28505	-2.28522	
5	-2.28889	-2.28329	
6	-2.28121	-2.28522	
min	-2.28889	-2.28522	
max	-2.28121	-2.28329	
stdev	0.00320	0.00096	
average	-2.28537	-2.28474	
+3S	-2.27577	-2.28184	
-3S	-2.29497	-2.28763	

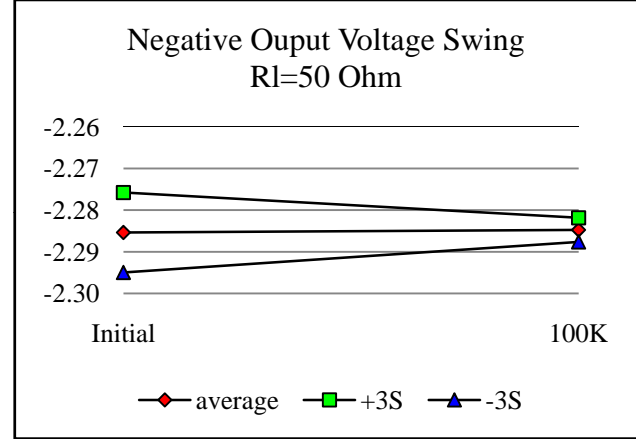
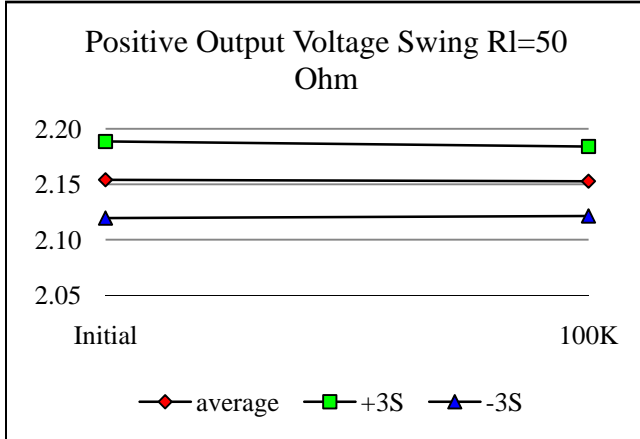

T# 11	Aol Vs=±2.5V RI=1k Ohm		dB
SN	Initial	100K	
2	92.02574	98.04079	
3	94.51897	92.00352	
4	94.53006	94.5356	
5	92.0202	92.03128	
6	92.03129	92.00909	
min	92.02020	92.00352	
max	94.53006	94.53560	
stdev	1.44268	1.26054	
average	93.27513	92.64487	
+3S	97.60317	96.42650	
-3S	88.94709	88.86325	

T# 13	+ Ibias Vs=±2.5V		uA
SN	Initial	100K	
2	-1.47506	-1.50016	
3	-1.56607	-1.66336	
4	-1.48134	-1.57548	
5	-1.47506	-1.63825	
6	-1.63198	-1.71357	
min	-1.63198	-1.71357	
max	-1.47506	-1.57548	
stdev	0.07481	0.05741	
average	-1.53861	-1.64767	
+3S	-1.31418	-1.47542	
-3S	-1.76305	-1.81991	

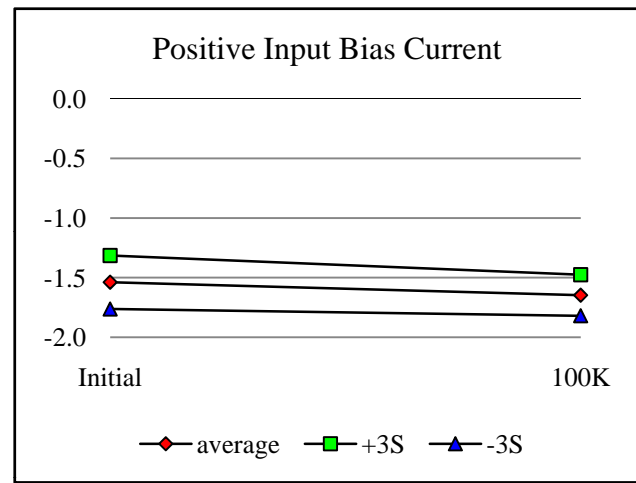
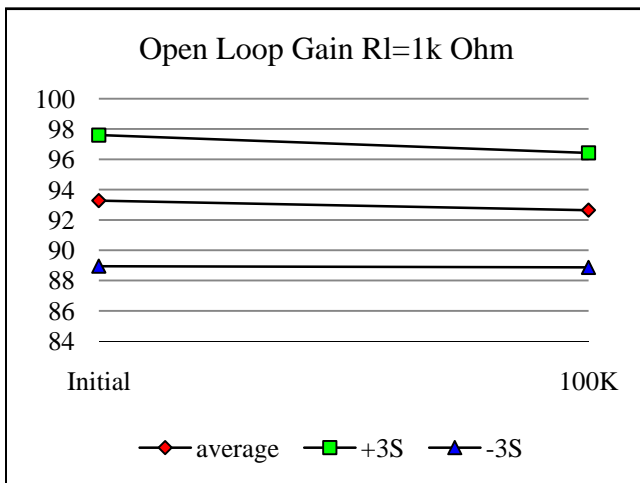

T# 14	- I _{bias} V _s =±2.5V		uA
SN	Initial	100K	
2	-1.53469	-1.52213	
3	-1.6257	-1.71044	
4	-1.51586	-1.58176	
5	-1.53469	-1.67905	
6	-1.69475	-1.7732	
min	-1.69475	-1.77320	
max	-1.51586	-1.58176	
stdev	0.08321	0.07982	
average	-1.59275	-1.68611	
+3S	-1.34311	-1.44664	
-3S	-1.84239	-1.92558	

T# 15	I _{OS} V _s =±2.5V		uA
SN	Initial	100K	
2	0.05963	0.02197	
3	0.05963	0.04708	
4	0.03452	0.00628	
5	0.05963	0.0408	
6	0.06277	0.05963	
min	0.03452	0.00628	
max	0.06277	0.05963	
stdev	0.01316	0.02283	
average	0.05414	0.03845	
+3S	0.09362	0.10693	
-3S	0.01465	-0.03004	

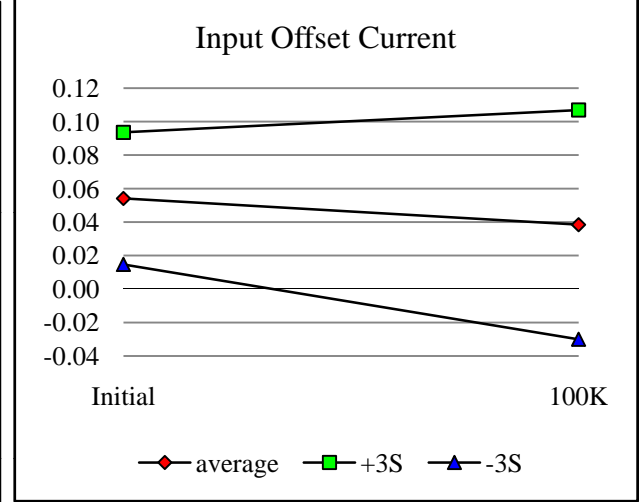
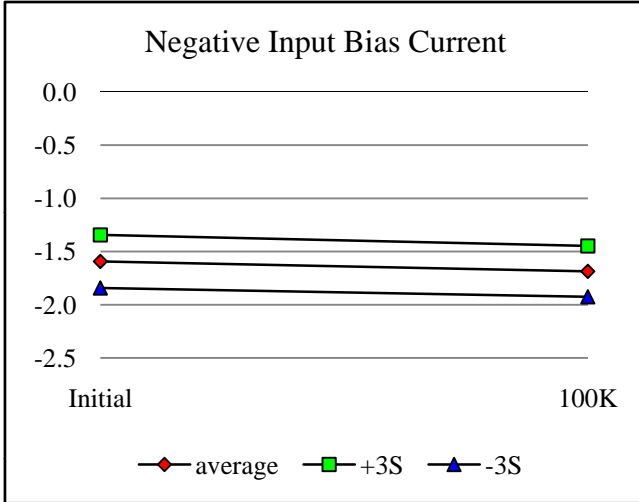

T# 21	PSRR V _s =±2.5V		dB
SN	Initial	100K	
2	126.462	126.704	
3	127.750	127.466	
4	142.248	138.716	
5	125.956	125.716	
6	128.053	128.955	
min	125.956	125.716	
max	142.248	138.716	
stdev	7.554	5.821	
average	131.002	130.213	
+3S	153.665	147.676	
-3S	108.339	112.751	

T# 22	CMRR		dB
SN	Initial	100K	
2	85.679	85.384	
3	86.299	85.983	
4	87.692	88.078	
5	82.885	83.105	
6	84.045	84.297	
min	82.885	83.105	
max	87.692	88.078	
stdev	2.168	2.160	
average	85.230	85.366	
+3S	91.736	91.844	
-3S	78.725	78.887	

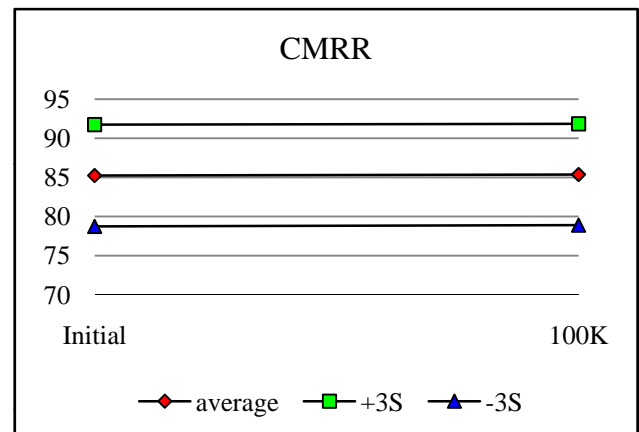
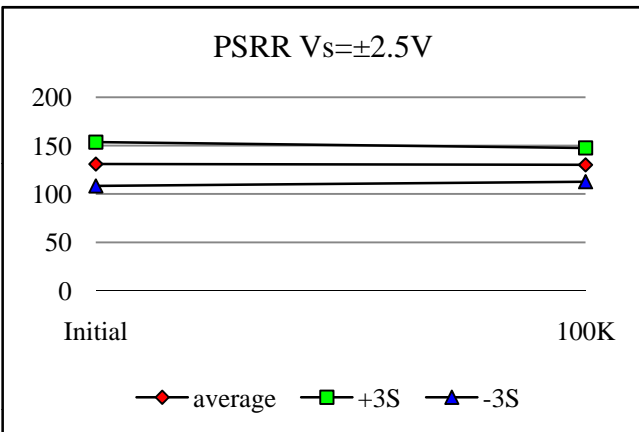

T# 23	Disable Current		mA
SN	Initial	100K	
2	1.29092	1.28954	
3	1.26853	1.27355	
4	1.27813	1.28315	
5	1.27813	1.28635	
6	1.27493	1.26715	
min	1.26853	1.26715	
max	1.27813	1.28635	
stdev	0.00453	0.00881	
average	1.27493	1.27755	
+3S	1.28851	1.30399	
-3S	1.26135	1.25111	

