

SINGLE EVENT LATCH-UP TEST REPORT

PRODUCT:	AD574S
DIE TYPE:	B574 (6")
DATE CODE:	0946
CASE TEMPERATURE:	125°C
EFFECTIVE LET:	83MeV-cm ² /mg
MINIMUM FLUENCE:	1E7 ion/cm ²
FLUX:	~2E5 ion/cm ² -s
FACILITIES:	Lawrence Berkeley National Laboratories
TESTED:	April 2010

The RADTESTSM DATA SERVICE is a compilation of radiation test results on Analog Devices' Space grade products. It is designed to assist customers in selecting the right product for applications where radiation is a consideration. Many products manufactured by Analog Devices, Inc. have been shown to be radiation tolerant to most tactical radiation environments. Analog Devices, Inc. does not make any claim to maintain or guarantee these levels of radiation tolerance without lot qualification test.

It is the responsibility of the Procuring Activity to screen products from Analog Devices, Inc. for compliance to Nuclear Hardness Critical Items (HCI) specifications.

WARNING:

Analog Devices, Inc. does not recommend use of this data to qualify other product grades or process levels. Analog Devices, Inc. is not responsible and has no liability for any consequences, and all applicable Warranties are null and void if any Analog product is modified in any way or used outside of normal environmental and operating conditions, including the parameters specified in the corresponding data sheet. Analog Devices, Inc. does not guarantee that wafer manufacturing is the same for all process levels.





Single Event Latchup Testing of the AD574 Successive-Approximation A/D Converter for Analog Devices

Customer: Analog Devices (PO# 45290784)

RAD Job Number: 10-084

Part Types Tested: Analog Devices AD574 Successive-Approximation A/D Converter

Traceability Information: Lot Date Code: 0946A; see a photograph of sample unit-under-test for traceability information in Appendix A.

Quantity of Parts for Testing: Three units were exposed to $1E7\text{ion}/\text{cm}^2$ at an LET of approximately $80\text{MeV}\cdot\text{cm}^2/\text{mg}$ using worst-case bias and temperature test conditions

Pre-Irradiation Burn-In: Units-under-test were not burned-in prior to the SEL testing.

Referenced Test Standard(s): ASTM F1192, EIA/JESD57

Electrical Test Conditions: Supply current monitored during exposure.

Test Software / Hardware: ICC.XLS, See Appendix C, Table C.1 for a list of test equipment and calibration dates.

Bias Conditions: All units-under-test were biased during heavy ion irradiation using supply potentials in-line with Analog Devices burn-in conditions. These conditions were in general accordance with ASTM F1192 and EIA/JESD57. See Appendix B for the details of the bias conditions.

Ion Energy and LET Ranges: Minimum of $10\text{MeV}/\text{n}$ Xe beams with effective LETs of approximately $80\text{MeV}\cdot\text{cm}^2/\text{mg}$. The $10\text{MeV}/\text{n}$ Xe beam had a minimum range of approximately $60\mu\text{m}$ in silicon to the Bragg Peak.

Heavy Ion Flux and Maximum Fluence Levels: Flux of approximately 1 to $2E5\text{ions}/\text{cm}^2$. Minimum $1E7\text{ions}/\text{cm}^2$ per unit tested

Facility and/or Radiation Source: Lawrence Berkeley National Laboratories (LBNL) Berkeley, CA ($10\text{MeV}/\text{n}$ beam) or Texas A&M ($15\text{MeV}/\text{n}$ beam).

Irradiation Temperature: 125°C case temperature as specified as the worst-case use condition by the customer.

Units PASSED latch-up at an effective LET of approximately $80\text{MeV}\cdot\text{cm}^2/\text{mg}$ with no significant change in supply current. The units were exposed to a minimum total fluence of $1E7\text{ion}/\text{cm}^2$



1.0. Overview and Background

It is well known that heavy ion exposure can cause temporary and/or permanent damage in electronic devices. The damage can occur through various mechanisms including single event latch-up (SEL), single event burnout (SEB) and single event gate rupture (SEGR). An SEL event occurs when a parasitic npnp feedback latch structure becomes biased into the on state due to a dense track of electron-hole pairs created along the heavy ion path in silicon. This latch-up is self-sustaining since there is a positive feedback path created and requires a power cycle to reset. A single event latch-up can lead to single event burnout if the current draw from the SEL event is sufficient to damage the junction and/or bond wire. The damage is worse and/or becomes evident with increasing linear energy transfer (LET) and fluence. The two test standards usually used to govern this testing are ASTM F1192 and EIA/JESD57. This destructive testing is usually performed at the maximum datasheet voltage and temperature to a total fluence of not less than $1E7\text{ion/cm}^2$.

2.0. Single Event Latch-Up Test Apparatus

The single event latch-up testing described in this final report was performed at the Lawrence Berkeley National Laboratories (LBNL) using the 88-Inch Cyclotron. The 88-Inch Cyclotron is operated by the University of California for the US Department of Energy (DOE) and is a K=140 sector-focused cyclotron with both light- and heavy-ion capabilities. Protons and other light-ions are available at high intensities (10-20 μA) up to maximum energies of 55 MeV (protons), 65 MeV (deuterons), 135 MeV (3He) and 140 MeV (4He). Most heavy ions through uranium can be accelerated to maximum energies, which vary with the mass and charge state.

For the SEL testing described in this final report the units-under-test were placed in the Cave 4B vacuum chamber aligned with the heavy ion beam line. The test platter in the vacuum chamber has full x and y alignment capabilities along with 2-dimensional rotation, allowing for a variety of effective LETs for each ion. For SEE testing Lawrence Berkeley Laboratories provides the dosimetry via a local control computer running a Lab View based program. Each ion is calibrated just prior to use using five photomultiplier tubes (PMTs). Four of the five PMTS are used during the test to provide the beam statistics, while the center PMT is removed following calibration. Figure 2.1 shows an illustration of the LBL facility; including the location of Cave 4B, where the heavy ion SEE testing takes place.

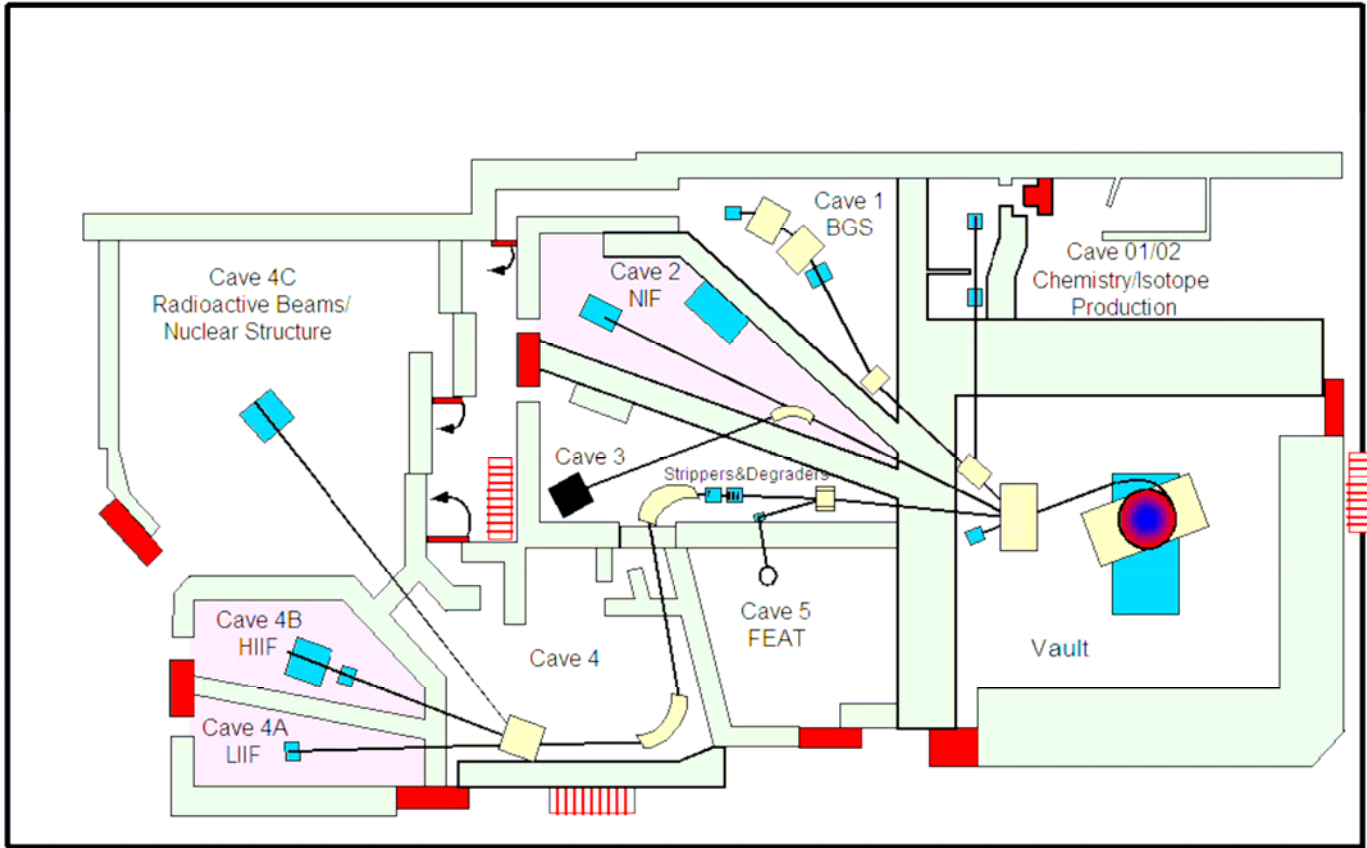

Figure 2.1. Map of 88-Inch Cyclotron Facility showing the location of Cave 4B, where the SEE testing was performed.



3.0. Radiation Test Conditions

The AD574 Successive-Approximation A/D Converter described in this final report was irradiated using Xe with three independent supply potentials of +5V and $\pm 15V$ and at a case temperature of $125^{\circ}C$ ($\pm 5^{\circ}C$). See the test circuit schematic in Appendix B for the specific details of the bias conditions. The 10MeV/n beam was used to provide sufficient range in silicon while meeting the maximum LET requirements of the program. The other beams available at Berkeley are the 4.5MeV/n beam and the 16MeV/n beam. The 4.5MeV/n beam does not provide sufficient range for destructive SEE testing while the 16MeV/n beam provides a much smaller selection of ions. Figure 3.1 shows the 10MeV/n beam characteristics for Xe. As seen in the figure, the range to the Bragg Peak is approximately $60\mu m$ while the surface LET is approximately $58MeV\text{-}cm^2/mg$ for the Xe beam. Figure 3.2 shows the characteristics for all the beams available at Berkeley. Note that the units were de-encapsulated prior to testing and all exposures took place from the top surface providing a distance to the active layer in Silicon of approximately 5 to $10\mu m$.

As noted above, the devices were irradiated to a minimum fluence of $1E7\text{ion}/cm^2$. The flux varied during the testing, but was consistently targeted to approximately $2E5\text{ion}/cm^2\text{-s}$. The irradiation of the units-under-test continued until either the minimum fluence was reached or a latchup event was observed.

For the elevated temperature required for single event latch-up testing an aluminum plate heater fixed to the back of the board and was used to heat the device-under-test (DUT) with an RTD used to monitor the temperature. The case temperature of the DUT was calibrated prior to the testing to the RTD with a thermocouple, allowing the RTD to provide feedback and maintain a calibrated $125^{\circ}C$ case temperature throughout the testing. The data monitored during the test (case temperature, supply voltage and supply current) was routed to the control room (approximately 20-feet away) using shielded coaxial cable.

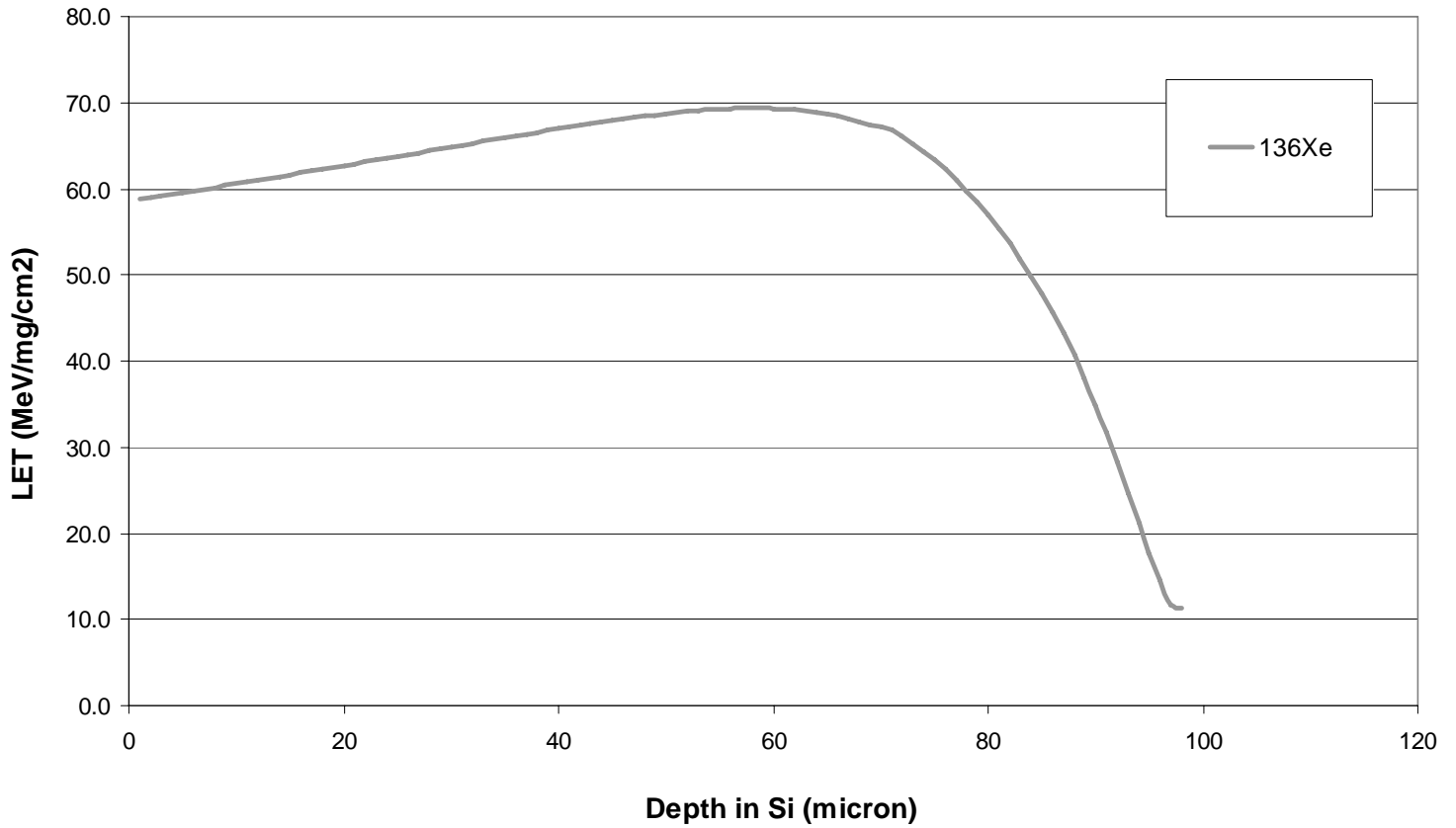

Figure 3.1. Range of the 10MeV/n Xe beam into silicon. The range to the Bragg Peak is approximately 60 μ m while the surface LET is approximately 58MeV-cm²/mg.



Ion	Cocktail (MeV/nuc)	Energy (MeV)	Z	A	Chg. State	% Nat. Abund.	LET 0*	LET 60*	Range (μm)	Method
B	4.5	44.90	5	10	+2	19.9	1.65	3.30	78.5	MIVOC
N	4.5	67.44	7	15	+3	0.37	3.08	6.16	67.8	Gas
Ne	4.5	89.95	10	20	+4	90.48	5.77	11.54	53.1	Gas
Si ¹	4.5	139.61	14	29	+6	4.67	9.28	18.56	52.4	Gas
Ar	4.5	180.00	18	40	+8	99.6	14.32	28.64	48.3	Gas
V	4.5	221.00	23	51	+10	99.75	21.68	43.36	42.5	Probe
Cu	4.5	301.79	29	63	+13	69.17	29.33	58.66	45.6	Probe
Kr	4.5	387.08	36	84	+17	17.3	38.96	77.92	48.0	Gas
Y	4.5	409.58	39	89	+18	100	45.58	91.16	45.8	Probe
Ag	4.5	499.50	47	109	+22	48.161	58.18	116.36	46.3	Probe
Xe	4.5	602.90	54	136	+27	8.9	68.84	137.68	48.3	Gas
Tb	4.5	724.17	65	159	+32	100	77.52	155.04	52.4	Probe
Ta	4.5	805.02	73	181	+36	99.988	87.15	174.30	53.0	Probe
Bi	4.5	904.16	83	209	+41	100	99.74	199.48	52.9	Oven
B	10	108.01	5	11	+3	80.1	0.89	1.78	305.7	MIVOC
O	10	183.47	8	18	+5	0.2	2.19	4.38	226.4	Gas
Ne	10	216.28	10	22	+6	9.25	3.49	6.98	174.6	Gas
Si ¹	10	291.77	14	29	+8	4.67	6.09	12.18	141.7	Gas
Ar	10	400.00	18	40	+11	99.6	9.74	19.48	130.1	Gas
V	10	508.27	23	51	+14	99.75	14.59	29.18	113.4	Probe
Cu	10	659.19	29	65	+18	30.83	21.17	42.34	108.0	Probe
Kr	10	906.45	36	84	+24	57	30.23	60.46	113.1	Gas
Y	10	928.49	39	89	+25	100	34.73	69.46	102.2	Probe
Ag	10	1039.42	47	107	+29	51.839	48.15	96.30	90.0	Probe
Xe	10	1232.55	54	124	+34	0.1	58.78	117.56	90.0	Gas
N	16	233.75	7	14	+5	99.63	1.16	2.32	505.9	Gas
O	16	277.33	8	17	+6	0.04	1.54	3.08	462.4	Gas
Ne	16	321.00	10	20	+7	90.48	2.39	4.78	347.9	Gas
Si ¹	16	452.10	14	29	+10	4.67	4.56	9.12	274.3	Gas
Cl	16	539.51	17	35	+12	75.77	6.61	13.22	233.6	Natural
Ar	16	642.36	18	40	+14	99.600	7.27	14.54	255.6	Gas
V	16	832.84	23	51	+18	99.750	10.90	21.80	225.8	Probe
Cu	16	1007.34	29	63	+22	69.17	16.53	33.06	190.3	Probe
Kr	16	1225.54	36	78	+27	0.35	24.98	49.96	165.4	Gas
Xe	16	1954.71	54	124	+43	0.1	49.29	98.58	147.9	Gas
N	30	425.45	7	15	+7	0.37	0.76	1.52	1370.0	Gas
O	30	490.22	8	17	+8	0.04	0.98	1.96	1220.0	Gas
Ne	30	620.00	10	21	+10	0.27	1.48	2.96	1040.0	Gas
Ar	30	1046.11	18	36	+17	0.337	4.87	9.74	578.1	Gas

¹By Special request

Figure 3.2. Characteristics of all the beams available at Berkeley. For the testing discussed in this report the 10MeV/n beam was used exclusively.



4.0. Tested Parameters

During the heavy ion exposure, the supply currents to the unit-under-test was measured and recorded in approximately 1-second increments. A plot of supply current versus time/fluence for each of the heavy ion exposures is included in this final report. Figure 4.1 shows the test board used for the SEL testing described in this final report. The test board was mounted on the test stage at Berkeley and provided 3-axis of motion plus rotation. The board had multiple units-under-test that allowed for sequential testing of the units without vacuum breaks during testing.

In general the following minimum criteria must be met for a device to pass SEL testing: During the heavy ion exposure the DUT's supply current must remain within the unit's specification limit without cycling power. If this condition is not satisfied following the heavy ion testing, then the SEL testing could be logged as a failure. Note that during heavy ion testing a substantial amount of total dose can be absorbed by the units-under-test. If a functional failure occurs during or following the testing, it is important to separate TID failures from destructive single event effects. Also, a single event latch-up may not be a "destructive" event since it is still functional, however a unit which experiences an SEL (i.e., a high sustained supply current requiring a power cycle to recover) is considered to have failed this test even if the units are functional and meet parametric limits following the testing.

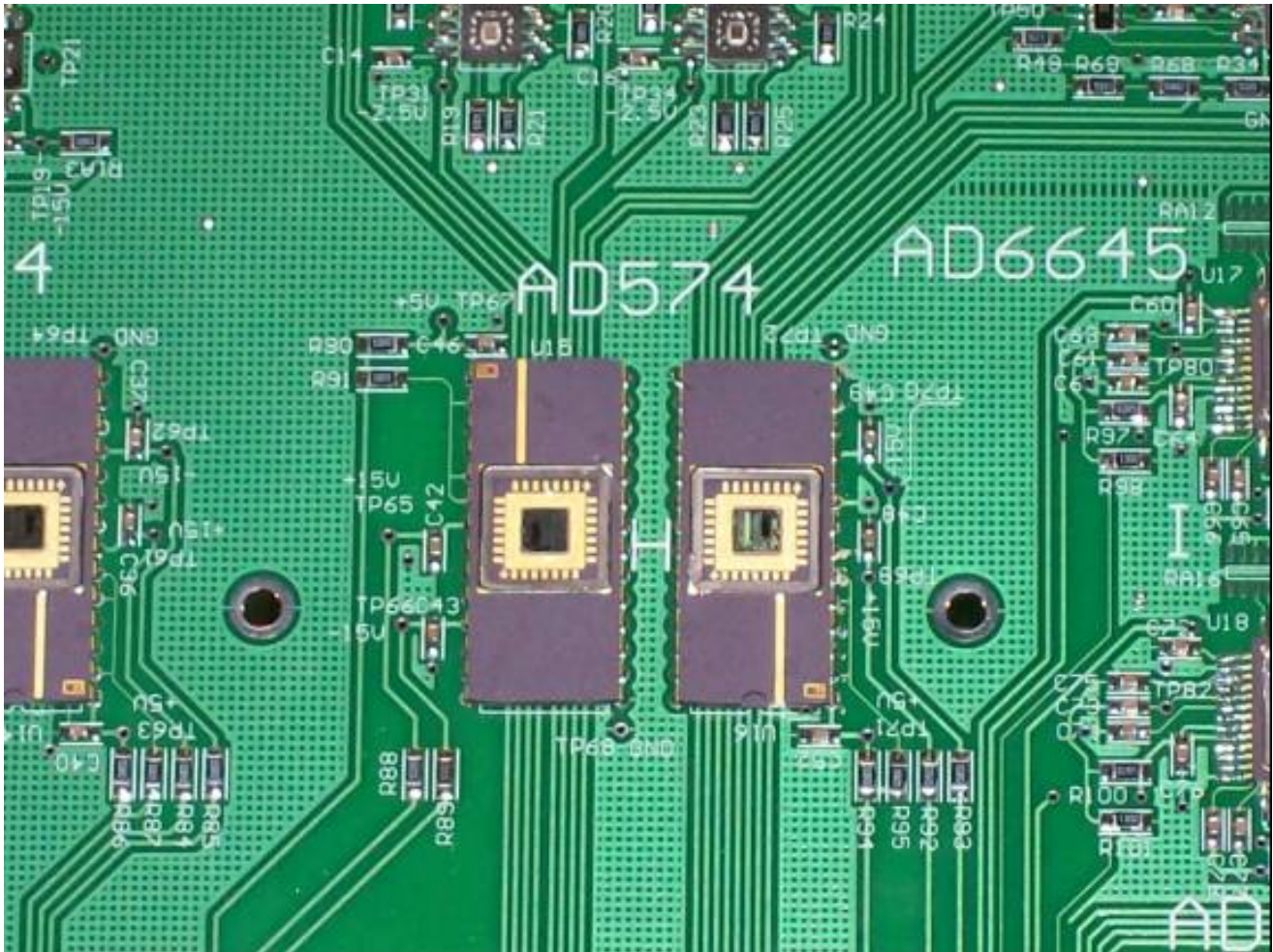

Figure 4.1. Single event test board mounted on the test stage at Berkeley. The board has four units-under-test mounted simultaneously to minimize vacuum breaks during testing. There is also a heater plate mounted to the backside of the board to provide the elevated temperature required for this testing.



5.0. Single Event Latch-Up Test Results

Using the criteria established for pass/fail of this single event latchup test, the AD574 Successive-Approximation A/D Converter (of the lot date code identified on the first page of this report) passed the SEL test at the minimum tested LET of 80MeV-cm²/mg and using worst-case bias and temperature test conditions for this device type (See Appendix B for details on the bias conditions during the SEE testing). None of the four units-under-test exhibited any significant increase in supply current during the beam run.

Table 5.1 show a summary of the single event latch-up data acquired. The table shows the part type (AD574), the serial number of the part irradiated, the test configuration (all units irradiated in a static configuration), the case temperature during testing, the ion species, the effective fluence, the effective LET, the number of SEL events recorded and the SEL cross-section.

Figures 5.1 through 5.3 show the supply current data during the SEL runs for all three units-under-test. In these figures the supply current is plotted as a function of time. The plots show the response of the units-under-test from the start to the end of the exposure (total of 1E7ion/cm²). As seen in these figures, the units-under-test do not show any significant change in supply current during the course of the exposure.

Table 5.1. Summary of the SEL test runs for the AD574 Successive-Approximation A/D Converter.

Part Type	SN	Configuration	Temp Deg C	Ion Species/ Energy	Eff. Fluence (ion/cm2)	Effective LET (MeV-cm ² /mg)	SEL Events	SEL Cross-Section
AD574	U13	Static Bias	125	Xe 10MeV/n	1.01E+07	83.0	0	0.00E+00
AD574	U14	Static Bias	125	Xe 10MeV/n	1.01E+07	83.0	0	0.00E+00
AD574	U16	Static Bias	125	Xe 10MeV/n	1.01E+07	83.0	0	0.00E+00

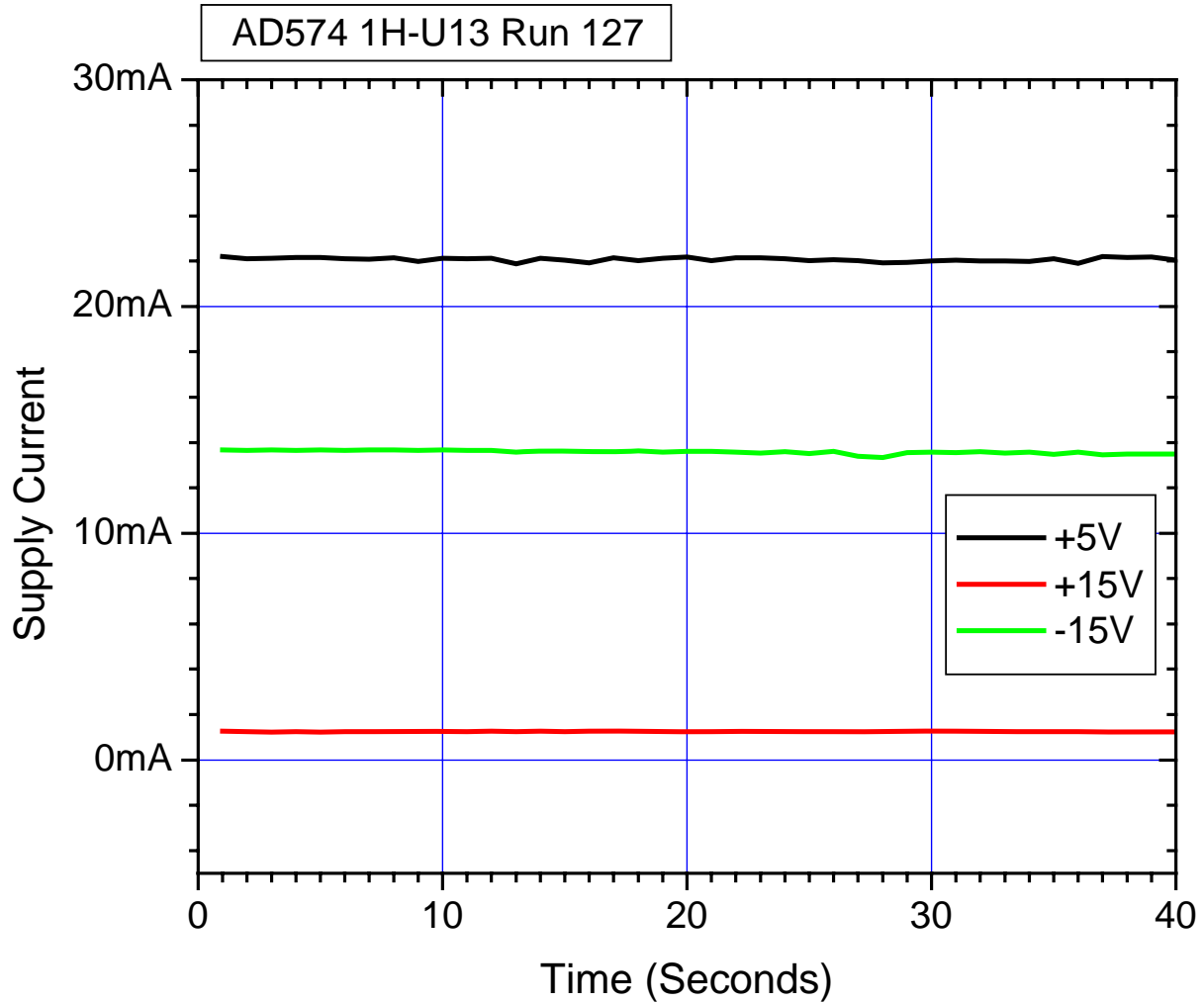

Figure 5.1. Supply current on versus time for AD574 unit numbers U13. The testing was performed at an effective LET of $83\text{MeV}\cdot\text{cm}^2/\text{mg}$ using Xe at an energy of $10\text{MeV}/\text{n}$. As seen in the figure, the supply current shows no significant increase during the run, indicating that the units-under-test have not experienced a latch-up event.

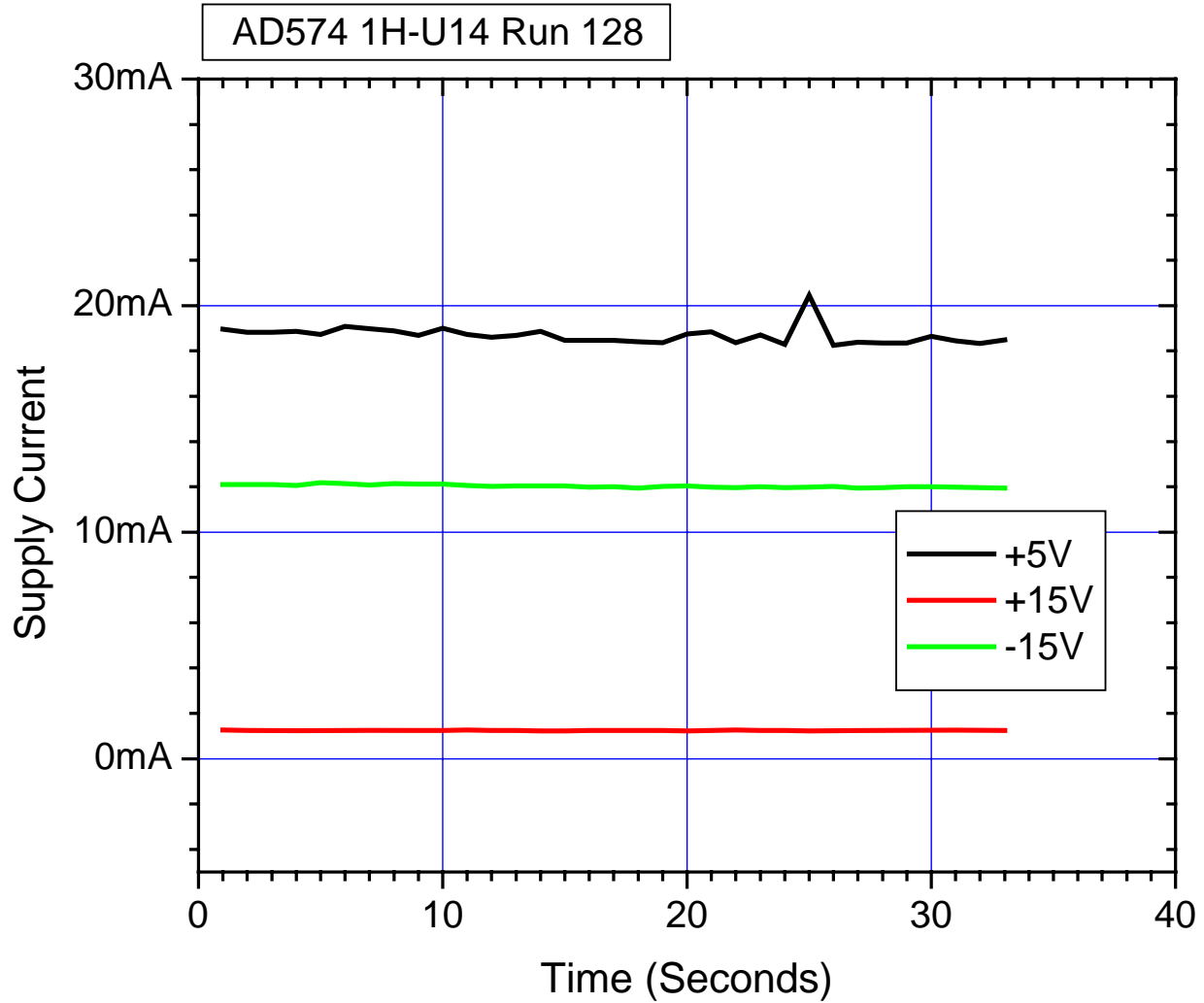

Figure 5.2. Supply current on versus time for AD574 unit numbers U14. The testing was performed at an effective LET of $83\text{MeV}\cdot\text{cm}^2/\text{mg}$ using Xe at an energy of $10\text{MeV}/\text{n}$. As seen in the figure, the supply current shows no significant increase during the run, indicating that the units-under-test have not experienced a latch-up event.

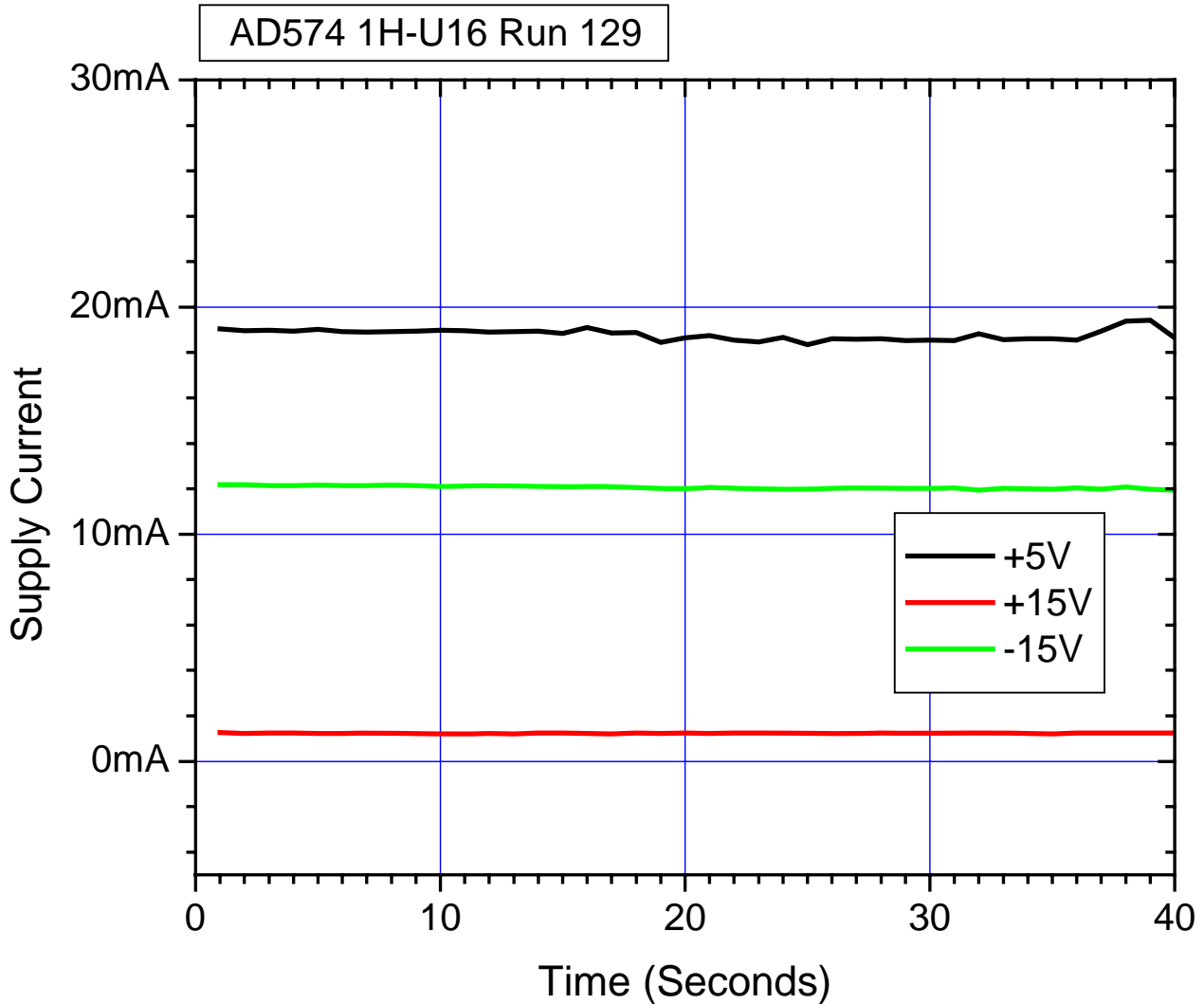

Figure 5.3. Supply current on versus time for AD574 unit numbers U16. The testing was performed at an effective LET of $83\text{MeV}\cdot\text{cm}^2/\text{mg}$ using Xe at an energy of $10\text{MeV}/\text{n}$. As seen in the figure, the supply current shows no significant increase during the run, indicating that the units-under-test have not experienced a latch-up event.



6.0. Summary/Conclusions

The single event latch-up testing described in this final report was performed at the Lawrence Berkeley National Laboratories (LBNL) using the 88-Inch Cyclotron. The 88-Inch Cyclotron is operated by the University of California for the US Department of Energy (DOE) and is a K=140 sector-focused cyclotron with both light- and heavy-ion capabilities.

The AD574 Successive-Approximation A/D Converter described in this final report was irradiated using Xe with three independent supply potentials of +5V and $\pm 15V$ and at a case temperature of $125^{\circ}C$ ($\pm 5^{\circ}C$). Note that additional voltages were generated on the test board using voltage dividers. See the test circuit schematic in Appendix B for the specific details of the bias conditions. Single event latchup on any of these generated potentials would have been observed on the primary power supply. The 10MeV/n beam was used to provide sufficient range in silicon while meeting the minimum LET requirements of the program of $80MeV\text{-}cm^2/mg$. The range to the Bragg Peak for Xe at this energy is approximately $60\mu m$.

The devices were irradiated to a minimum fluence of $1E7ion/cm^2$. The flux varied somewhat during the testing, but was approximately $1E5ion/cm^2\text{-}s$ to $2E5ion/cm^2\text{-}s$. During the testing the irradiations continued until either the minimum fluence was reached or a latchup event was observed. In general the following minimum criteria must be met for a device to pass SEL testing: During the heavy ion exposure the DUT's supply current must remain within the unit's specification limit without cycling power. If this condition is not satisfied following the heavy ion testing, then the SEL testing could be logged as a failure.

Using the criteria established for pass/fail of this single event latchup test, the AD574 Successive-Approximation A/D Converter (of the lot date code identified on the first page of this report) passed the SEL test at the minimum tested LET of $80MeV\text{-}cm^2/mg$ and using worst-case bias and temperature test conditions for this device type (See Appendix B for details on the bias conditions during the SEE testing). None of the four units-under-test exhibited any significant increase in supply current during the beam run.



Appendix A: Photograph of a Sample Unit-Under-Test for Device Traceability and a Decapsulated Unit Ready for SEL Testing

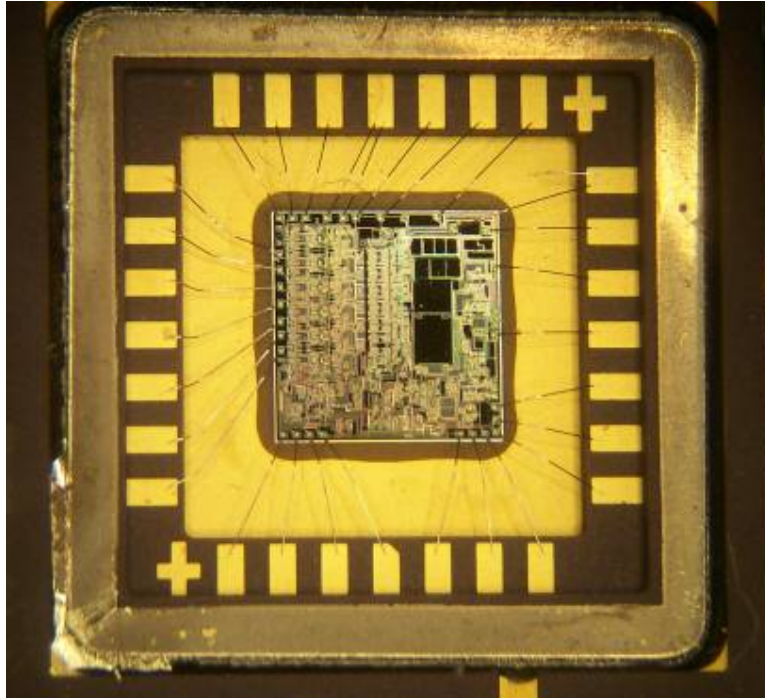



Appendix B: Electrical Bias Conditions Used During Heavy Ion Exposure

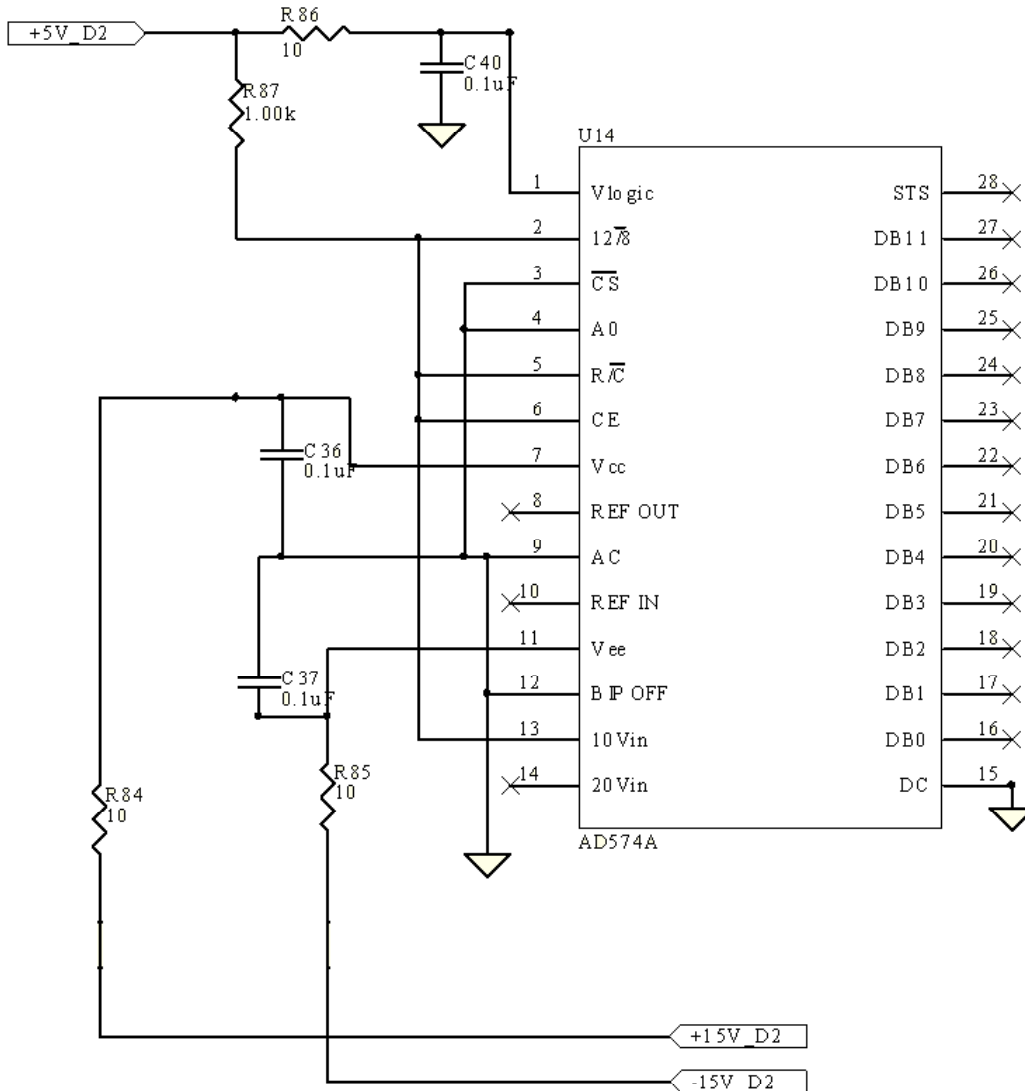

Figure B.1. Schematic drawing of the configurations used for the SEL test described in this final report.



Appendix C: Electrical Test Parameters and Equipment List:

The Analog Devices AD574 Successive-Approximation A/D Converter described in this final report was irradiated using the 10MeV/n Xe beam at the Lawrence Berkeley National Laboratories with three supply potentials of +5 V and $\pm 15V$ and at a case temperature of 125°C ($\pm 5^\circ C$). During the heavy ion exposure, the supply current to the unit-under-test was measured and recorded in approximately 1-second increments.

Table C.1 lists the equipment used during the testing as well as the calibration dates and the date the calibration is due.

Table C.1. Test equipment and calibration dates for testing the Analog Devices AD574 Successive-Approximation A/D Converter.

Equipment	Serial Number	Calibration Date	Calibration Due	Purpose
Instek SFG-2110	EF201999	N/A	N/A	Square Wave Input
HP 34401A Multimeter	3146A65284	5/15/09	5/15/10	Icc measurement
Agilent E3642A DC Power Supply	MY40004345	N/A	N/A	Test power supply-Positive Supply
Agilent E3631A DC Power Supply	K920920312	N/A	N/A	Test power supply-Negative Supply
Fluke Model 77 Multimeter	38301747	2/19/10	2/19/11	Vcc measurement at the DUT
Omega HH12 Handheld Thermometer	233126	2/19/10	2/19/11	Temperature Calibration
Tektronics TDS5104 Oscilloscope	B011044	10/22/09	10/22/10	Output Waveform Measurements, if applicable