

**196-Ball Ball Grid Array, Thermally Enhanced [BGA_ED]
(BP-196-4)**

Dimensions shown in millimeters

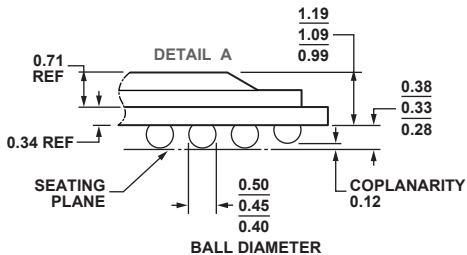
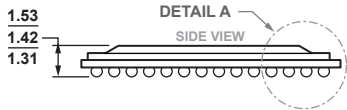
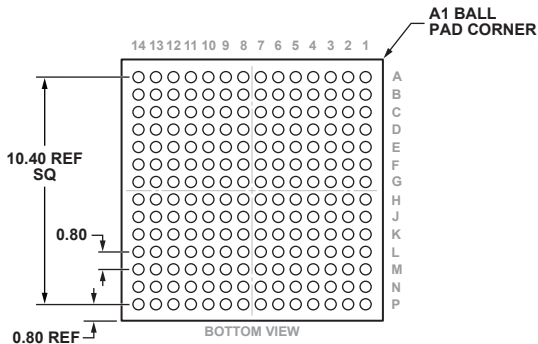
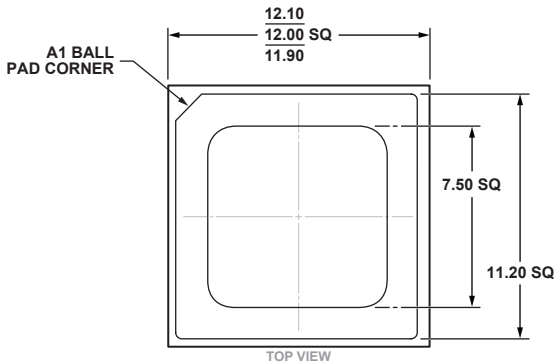

COMPLIANT TO JEDEC STANDARDS MO-275-GGAB-1.