

**192-Ball Ball Grid Array, Thermally Enhanced [BGA_ED]
(BP-192-1)**

Dimensions shown in millimeters

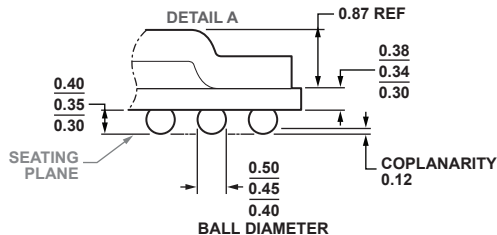
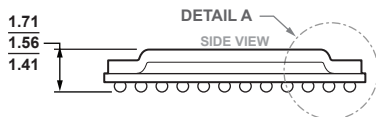
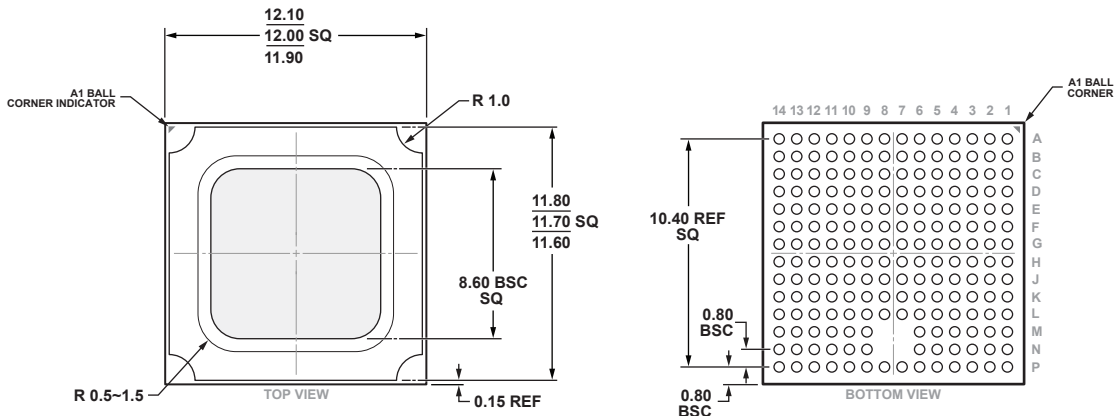

COMPLIANT TO JEDEC STANDARDS MO-275-GGAB-1.