

REV	DESCRIPTION	DATE	APPROVED
0	Initial composite dwg.	02/24/16	
1	Chg tray temp. rated 150°C to 180 °C	06/05/16	

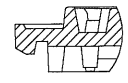

"MADE IN XXX..."  
(Country Of Origin)

- NOTES:
- 1 CLOSED CELLS FOR VACUUM OPERATION
  - 2 NON-BAKEABLE TRAYS SHOULD NOT BE EXPOSED TO TEMPERATURES GREATER THAN 100°C AT ANY TIME.
  - 3 INTERPRET DIMENSIONS AND TOLERANCES IN ACCORDANCE WITH ASME Y14.5M-1994.
  - 4 UNLESS OTHERWISE NOTED 1/2" DRAFT ON ALL VERTICAL SURFACE.
  - 5 REVISION LEVEL AND DATE CODES WILL BE ON BOTTOM SIDE OF THE TRAY. WHEN POSSIBLE REVISION LEVEL WILL BE LOCATED NEAR 45° CHAMFER.
  - 6 UNLESS SPECIFIED OTHERWISE, ELECTRONICALLY TRANSMITTED FILES ARE UNCONTROLLED DOCUMENTS.
  - 7 TRAY COMPLIANT WITH JEDEC CO-03A, VAR AA.
  - 8 MEASUREMENT FOR REDISTAL HEIGHT ONLY TAKEN FOR SOCKET ROWS ADJACENT TO SIDE RAILS.

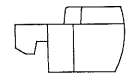
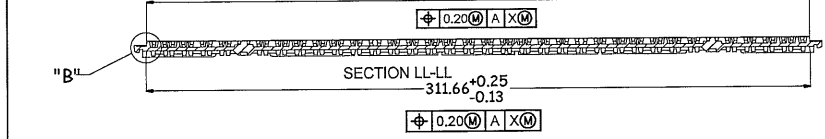
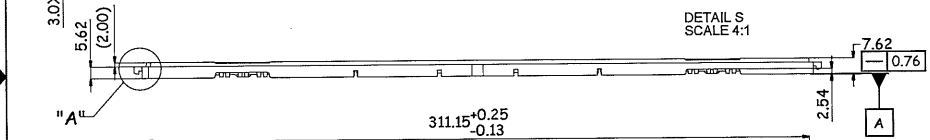
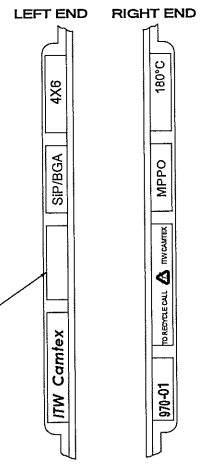
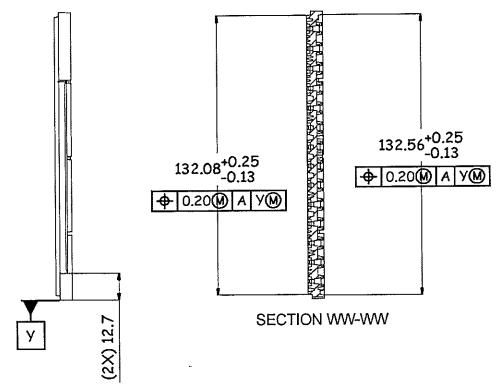
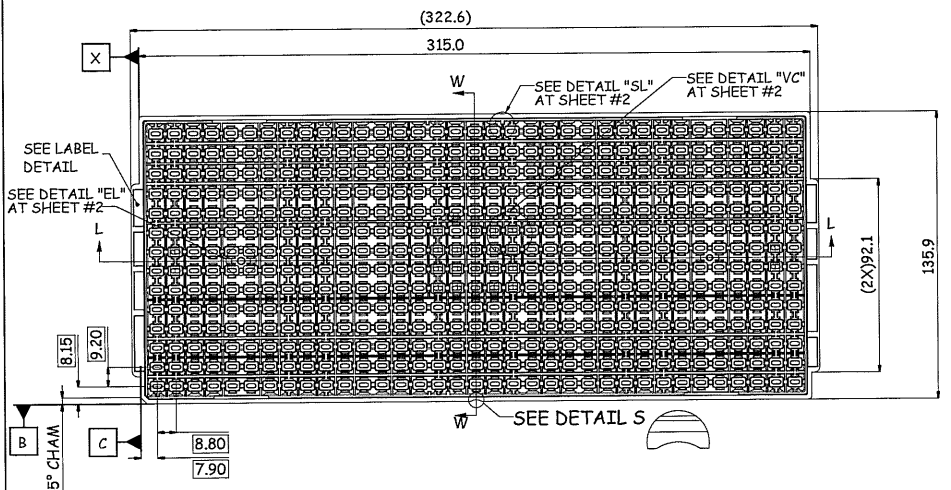
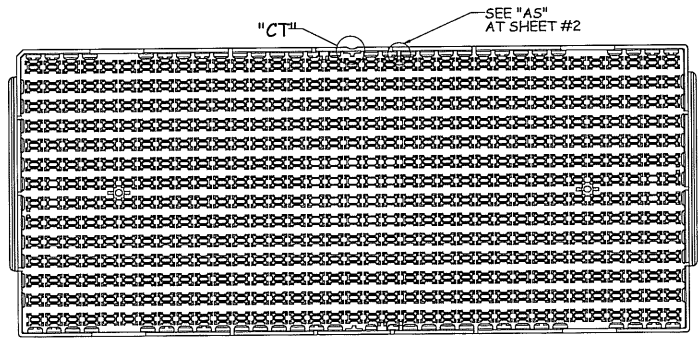
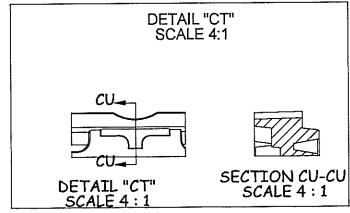

1630 McCarthy Blvd.  
 Milpitas, CA 95035  
 Phone: 408-432-1900  
 LTC Confidential

PIECE PART DRAWING

4.0X6.0mm SiP/BGA TRAY

(14X35 MATRIX)

DRAWING NO.		50-8012, REV. 1	
APPROVALS	DATE:	TOLERANCES UNLESS OTHERWISE SPECIFIED:	
DRAWN: M.OTHIANO / D.PRUITT		FRACTIONS N/A	DECIMALS XXX.XX ± 0.25 XXX.XXX ± 0.13
CHECKED: R.RANGANATHAN		SCALE NOT TO SCALE	ANGLES ± 1°
		SIZE N/A	SHEET 1 OF 3

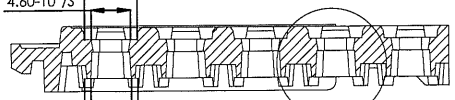
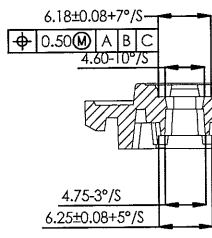
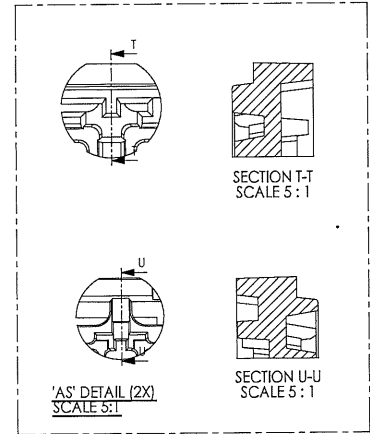
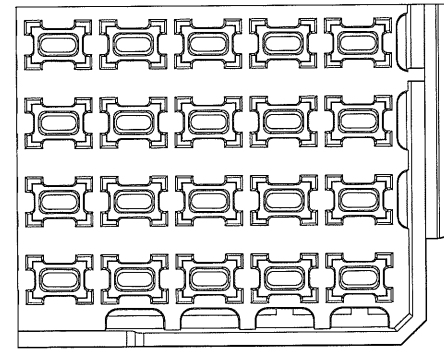
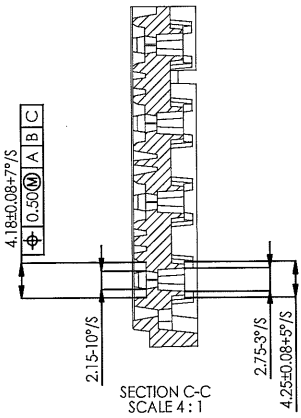
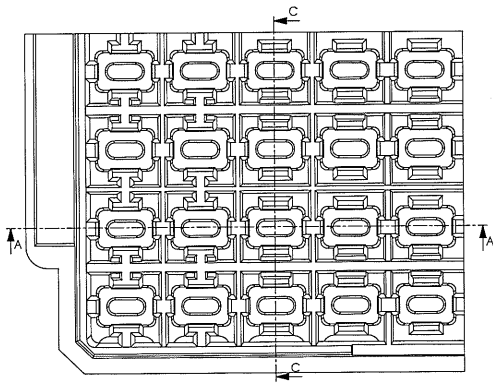

SECTION A-A  
SCALE 4:1

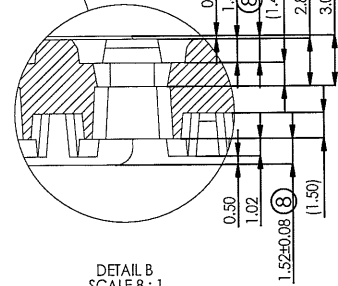

DETAIL B  
SCALE 8:1

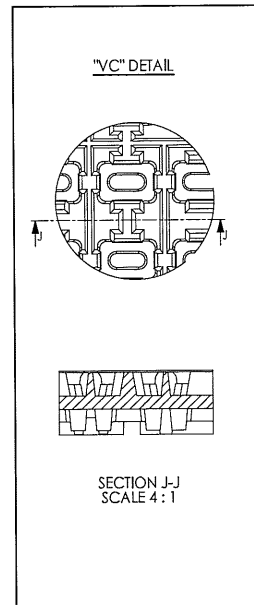

SECTION J-J  
SCALE 4:1

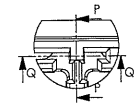

SECTION P-P  
SCALE 4:1

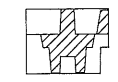

SECTION Q-Q  
SCALE 4:1

'SL' DETAIL (2X)  
SCALE 4:1

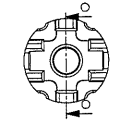

SECTION O-O  
SCALE 4:1

'EL' DETAIL  
SCALE 4:1



1630 McCarthy Blvd.  
Milpitas, CA, 95035  
Phone: 408-432-1900  
LTC Confidential

PIECE PART DRAWING  
4.0X6.0mm SIP/BGA TRAY  
(14X35 MATRIX)

DRAWING NO. 50-8012, REV.1

APPROVALS	DATE:	TOLERANCES UNLESS OTHERWISE SPECIFIED:		
DRAWN: M.OTHENO / D.PRUITT		FRACTIONS N/A	DECIMALS xx.xxx ± 0.02 xxx.xxx ± 0.15	ANGLES ± 1°
CHECKED: R.RANGANATHAN		SCALE NOT TO SCALE	SIZE N/A	SHEET 2 OF 3

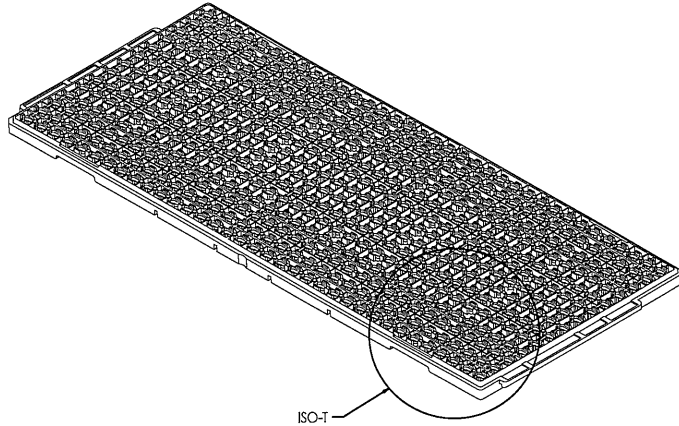

ISO-T

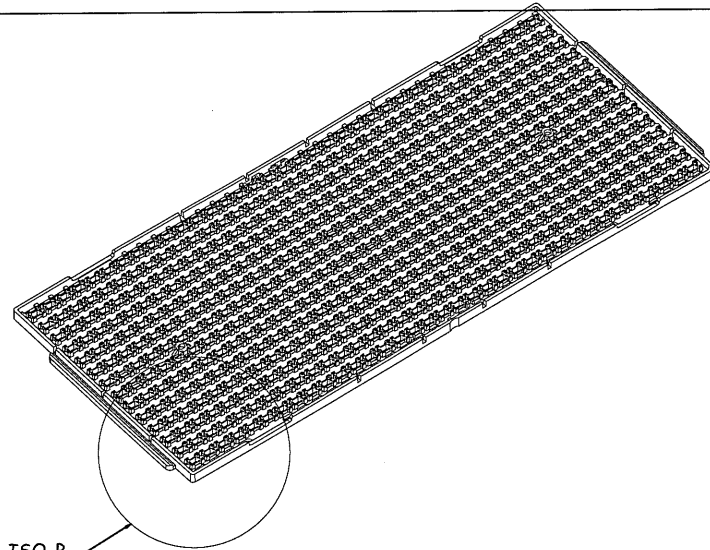

ISO-B

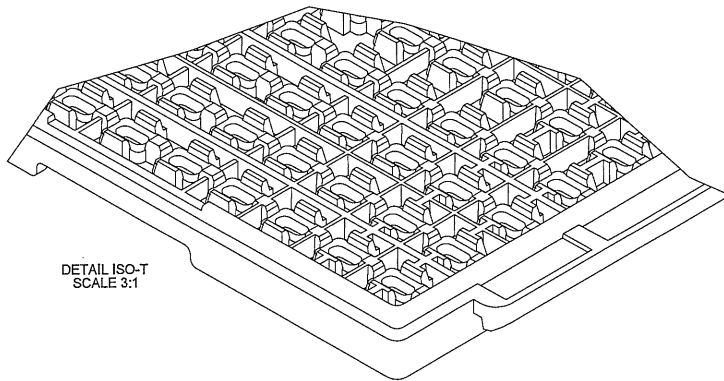

DETAIL ISO-T  
SCALE 3:1

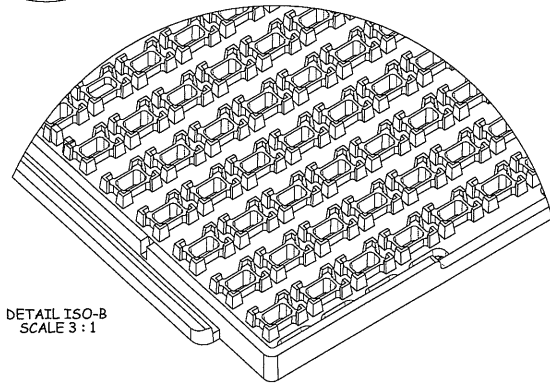

DETAIL ISO-B  
SCALE 3:1



1630 McCarthy Blvd.  
Milpitas, CA. 95035  
Phone: 408-432-1900  
LTC Confidential

PIECE PART DRAWING  
4.0X6.0mm SiP/BGA TRAY  
(14X35 MATRIX)

DRAWING NO.

50-8012, REV.1

APPROVALS

DATE:

DRAWN:  
M.OTHENO / D.PRUITT

TOLERANCES UNLESS OTHERWISE SPECIFIED:

FRACTIONS  
N/A

DECIMALS  
XX.XX ± 0.25  
XX.XXX ± 0.13

ANGLES  
± 1°

CHECKED:  
R.RANGANATHAN

SCALE

NOT TO SCALE

SIZE  
N/A

SHEET

3 OF 3