

BGA Package
162-Lead (6mm × 12mm × 3.76mm)
 (Reference LTC DWG# 05-08-7102 Rev 0)

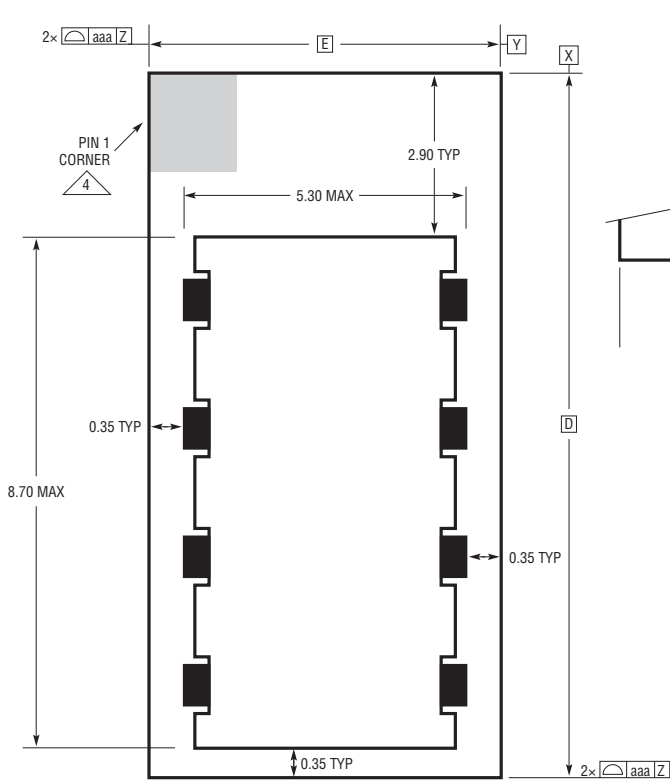

PACKAGE TOP VIEW

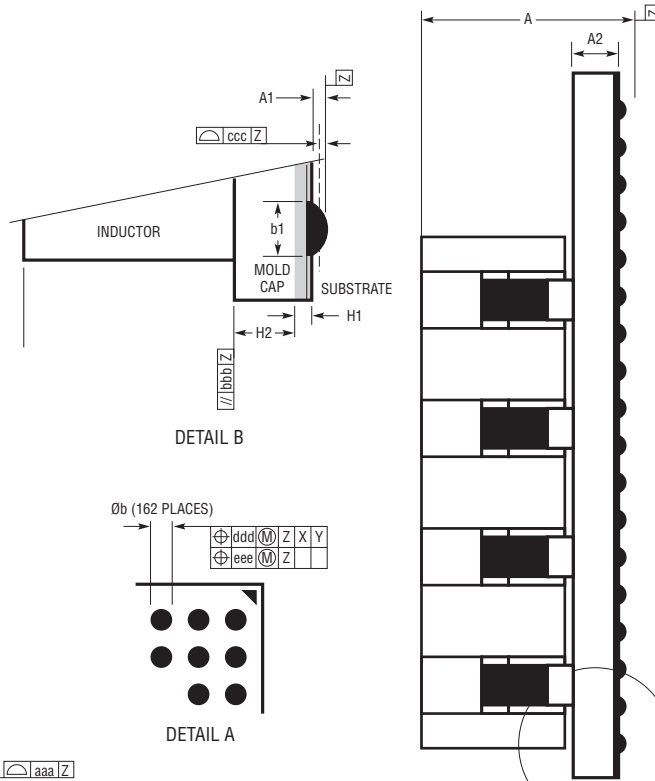

DETAIL B

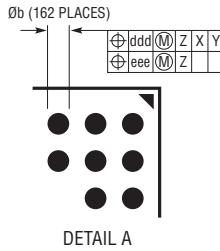

DETAIL A

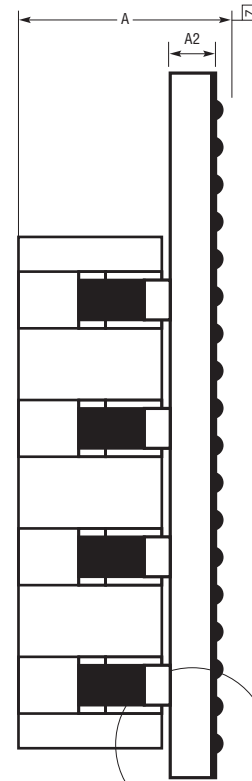

PACKAGE SIDE VIEW

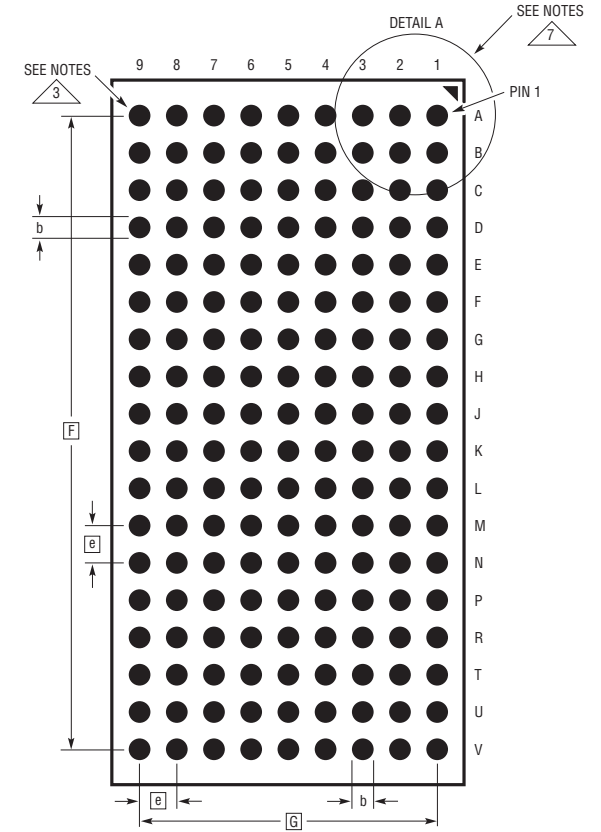

PACKAGE BOTTOM VIEW

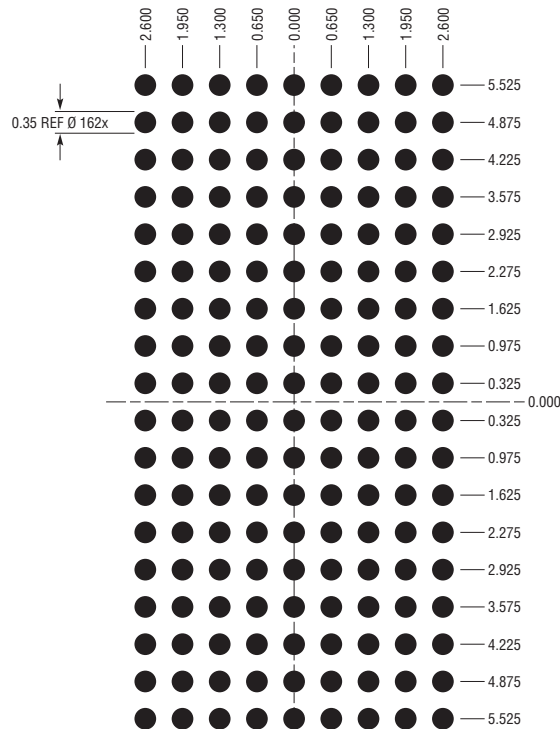

SUGGESTED PCB LAYOUT TOP VIEW

DIMENSIONS				
SYMBOL	MIN	NOM	MAX	NOTES
A	3.46	3.76	4.00	
A1			0.08	BALL HT
A2	0.86	0.95	1.04	
b	0.32	0.35	0.38	BALL DIMENSION
b1	0.32	0.35	0.38	PAD DIMENSION
D		12.00		
E		6.00		
e		0.65		
F		11.05		
G		5.20		
H1		0.25 REF		SUBSTRATE THK
H2		0.70 REF		MOLD CAP HT
H3	2.55	2.75	2.95	INDUCTOR HT
aaa			0.15	
bbb			0.10	
ccc			0.20	
ddd			0.25	
eee			0.10	

TOTAL NUMBER OF BALLS: 162

- NOTES:
1. DIMENSIONING AND TOLERANCING PER ASME Y14.5M-1994
 2. ALL DIMENSIONS ARE IN MILLIMETERS
 - 3 BALL DESIGNATION PER JEP95
 - 4 DETAILS OF PIN 1 IDENTIFIER ARE OPTIONAL, BUT MUST BE LOCATED WITHIN THE ZONE INDICATED. THE PIN 1 IDENTIFIER MAY BE EITHER A MOLD OR MARKED FEATURE
 5. PRIMARY DATUM -Z- IS SEATING PLANE
 - 6 PACKAGE ROW AND COLUMN LABELING MAY VARY AMONG µModule PRODUCTS. REVIEW EACH PACKAGE LAYOUT CAREFULLY

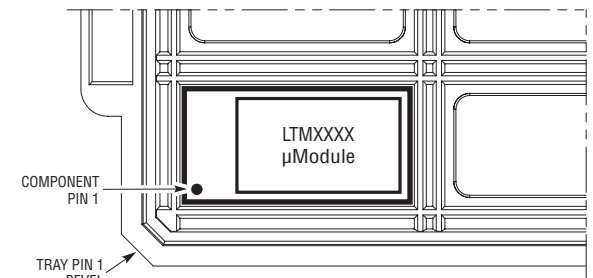

PACKAGE IN TRAY LOADING ORIENTATION