

72-Lead Lead Frame Chip Scale Package [LFCSP_VQ]
10 x 10 mm Body, Very Thin Quad
(CP-72-3)
Dimensions shown in millimeters

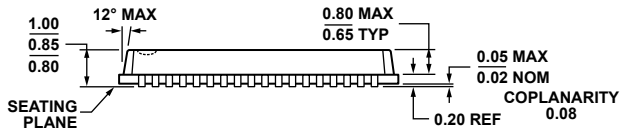
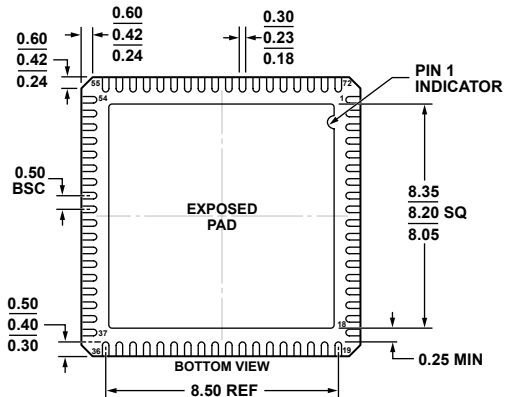
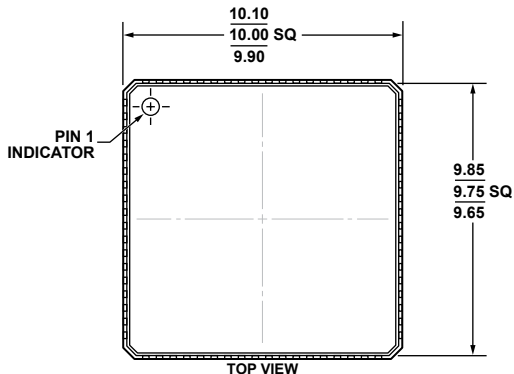

COMPLIANT TO JEDEC STANDARDS MO-220-VNND-4