

### FEATURES

- Full-featured evaluation board for the [AD5764](#)
- On-board reference
- On-board ADC for temperature readback
- Link options
- Direct hook-up to USB port of PC
- PC software for control

### EVALUATION BOARD DESCRIPTION

The EVAL-AD5764EB is a full-featured evaluation board designed to allow the user to easily evaluate all features of the AD5764 quad-channel, 16-bit DAC. All of the AD5764 pins are accessible at on-board connectors for external connection. The board can be controlled by two means, via the on-board connectors or via the USB port of a Windows®-based PC using the AD5764 evaluation software. The default setup is for control via the USB port.

### DEVICE DESCRIPTION

The AD5764 has a nominal output voltage span of  $\pm 10$  V derived from a reference voltage of +5 V. The part also includes a 3-wire serial interface that is compatible with SPI®, QSPI™, MICROWIRE™, and DSP interface standards. Data is written to the AD5764 in a 24-bit word format, and a data output pin (SDO) is also offered for daisy-chaining or readback.

The DAC outputs are updated upon reception of new data into the DAC registers. All the outputs can be simultaneously updated by taking the  $\overline{\text{LDAC}}$  input low.

Each channel has a programmable gain and offset adjust register. Each DAC output is buffered on-chip.

Complete specifications for the AD5764 are available in the AD5764 data sheet available from Analog Devices, Inc., and should be consulted in conjunction with this data sheet when using the evaluation board.

### FUNCTIONAL BLOCK DIAGRAM

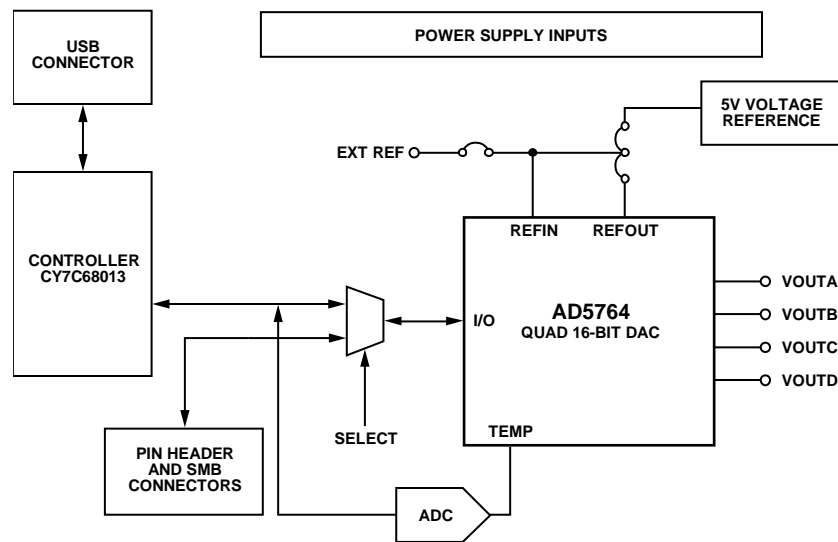

Figure 1.

05981-001

#### Rev. 0

Information furnished by Analog Devices is believed to be accurate and reliable. However, no responsibility is assumed by Analog Devices for its use, nor for any infringements of patents or other rights of third parties that may result from its use. Specifications subject to change without notice. No license is granted by implication or otherwise under any patent or patent rights of Analog Devices. Trademarks and registered trademarks are the property of their respective owners.

## TABLE OF CONTENTS

Features .....	1	Evaluation Board Software.....	5
Evaluation Board Description.....	1	Software Installation .....	5
Device Description .....	1	Software Operation .....	5
Functional Block Diagram .....	1	Schematics and Artwork .....	7
Revision History .....	2	Ordering Information .....	12
Evaluation Board Hardware .....	3	Bill of Materials.....	12
Power Supplies .....	3	Ordering Guide .....	12
Link Options .....	3	ESD Caution.....	12

## REVISION HISTORY

4/06—Revision 0: Initial Version

## EVALUATION BOARD HARDWARE

### POWER SUPPLIES

The following external supplies must be provided:

- 5 V between the 5 V and DGND inputs for the digital supply of the AD5764 and digital circuitry. Alternatively, place Link 1 in Position A to power the digital circuitry from the USB port (default).
- 12 V to 15 V between the  $AV_{DD}$  and AGND inputs for the positive analog supply of the AD5764.
- -12 V to -15 V between the  $AV_{SS}$  and AGND inputs for the negative analog supply of the AD5764.

Both AGND and DGND inputs are provided on the board. The AGND and DGND planes are connected at one location close to the AD5764. It is recommended not to connect AGND and DGND elsewhere in the system to avoid ground loop problems.

Each supply is decoupled to the relevant ground plane with 10  $\mu$ F and 0.1  $\mu$ F capacitors. Each device supply pin is again decoupled with a 10  $\mu$ F and 0.1  $\mu$ F capacitor pair to the relevant ground plane.

### LINK OPTIONS

The position of Link 11 configures the board for either PC control via the USB port (default setup) or for control by an external source via J21 or the SMB connectors. The link options on the evaluation board should be set for the required operating setup before using the board. The functions of the link options are described in Table 4.

### Default Link Option Setup

The default setup is for control by the PC via the USB port. The default link options are listed in Table 1.

**Table 1. Link and Switch Options for PC Control**

Link No.	Option
LK1	A
LK2	C
LK3	Inserted
LK4	B
LK5	A and B inserted
LK6	Removed
LK7	A
LK8	A
LK9	A
LK10	Removed
LK11	B
LK12	Inserted
LK13	Inserted
LK14	Inserted

### Connector J21 Pin Descriptions

**Table 2. Connector J21<sup>1</sup> Pin Configuration**

13	11	9	7	5	3	1
14	12	10	8	6	4	2

<sup>1</sup> LK11 must be in Position A to enable the use of J21.

**Table 3. Connector J21 Pin Descriptions**

Pin No.	Function
1	SYNC
2	SCLK
3	SDIN
4	SDO
5	LDAC
6	CLR
7	D0
8	D1
9	RSTOUT
10	RSTIN
11	BIN/2sCOMP
12	DGND
13	DGND
14	DGND

# EVAL-AD5764EB

Table 4. Link Options

Link No.	Function
LK1	This link selects the 5 V power supply source for the digital circuitry: <ul style="list-style-type: none"> <li>• Position A selects the USB port as the 5 V digital circuitry power supply source.</li> <li>• Position B selects J2 as the 5 V digital circuitry power supply source.</li> </ul>
LK2	This link selects the value of the short-circuit protection for the four DAC outputs: <ul style="list-style-type: none"> <li>• Position A selects a resistor value of 120 k<math>\Omega</math>, selecting a current value of 500 <math>\mu</math>A.</li> <li>• Position B selects a resistor value of 24 k<math>\Omega</math>, selecting a current value of 2.5 mA.</li> <li>• Position C selects a resistor value of 6 k<math>\Omega</math>, selecting a current value of 10 mA.</li> <li>• Position D selects a user-defined resistor value, selecting a user-defined current value.</li> </ul>
LK3	This link connects AGNDA to 0 V.
LK4	This link selects the reference source: <ul style="list-style-type: none"> <li>• Position A selects the internal reference as the reference source. (AD5764R)</li> <li>• Position B selects the on-board 5 V reference as the reference source.</li> </ul>
LK5	This link connects the selected reference source to REFAB and REFC: If sourcing REFAB external to the board via J3, Position B should not be inserted. If sourcing REFC external to the board via J4, Position A should not be inserted. <ul style="list-style-type: none"> <li>• Position A connects REFC to the selected on-board or internal reference source.</li> <li>• Position B connects REFAB to the selected on-board or internal reference source.</li> </ul>
LK6	This link connects the TEMP pin to the input of the on-board ADC (AD5764R): <ul style="list-style-type: none"> <li>• When inserted, the voltage at the TEMP pin can be readback to the PC.</li> <li>• When removed, the voltage at the TEMP pin is disconnected from the on-board ADC input.</li> </ul>
LK7	This link selects the digital supply voltage value for the AD5764, U7, U8, and U9: <ul style="list-style-type: none"> <li>• Position A selects +3.3 V as the supply value.</li> <li>• Position B selects +5 V as the supply value.</li> </ul>
LK8	This link selects the state of the $\overline{\text{LDAC}}$ pin: <ul style="list-style-type: none"> <li>• Position A allows the <math>\overline{\text{LDAC}}</math> pin to be driven from either the PC or via J21 or the SMB connectors.</li> <li>• Position B connects the <math>\overline{\text{LDAC}}</math> pin to DGND.</li> </ul>
LK9	This link selects the state of the $\overline{\text{BIN}/2\text{sCOMP}}$ pin when external control is selected via LK11: <ul style="list-style-type: none"> <li>• Position A connects the <math>\overline{\text{BIN}/2\text{sCOMP}}</math> pin to <math>\text{DV}_{\text{CC}}</math> selecting straight binary as the data coding format.</li> <li>• Position B connects the <math>\overline{\text{BIN}/2\text{sCOMP}}</math> pin to DGND selecting twos complement as the data coding format</li> <li>• Removing LK9 allows the <math>\overline{\text{BIN}/2\text{sCOMP}}</math> pin to be driven from J21.</li> </ul>
LK10	This link selects the state of the $\overline{\text{CLR}}$ pin when external control is selected via LK11: <ul style="list-style-type: none"> <li>• When inserted, the <math>\overline{\text{CLR}}</math> pin is connected to DGND and the four DAC outputs are cleared.</li> <li>• When removed, the <math>\overline{\text{CLR}}</math> pin is pulled to <math>\text{DV}_{\text{CC}}</math> through a 10 k<math>\Omega</math> resistor.</li> </ul>
LK11	This link selects whether the AD5764 evaluation board is controlled by the PC via the USB port or by an external source via J21 or the SMB connectors: <ul style="list-style-type: none"> <li>• Position A selects the evaluation board to be controlled by an external source via J21 or the SMB connectors.</li> <li>• Position B selects the evaluation board to be controlled by the PC via the USB port.</li> </ul>
LK12	This link connects AGNDB to 0 V.
LK13	This link connects AGNDC to 0 V.
LK14	This link connects AGNDD to 0 V.

# EVALUATION BOARD SOFTWARE

## SOFTWARE INSTALLATION

The AD5764 evaluation kit includes self-installing software on CD-ROM. The software is compatible with Windows 2000/NT/XP. If the setup file does not run automatically, **setup.exe** can be run from the CD-ROM.

The evaluation software should be installed before connecting the evaluation board to the PC's USB port to ensure that the evaluation board is correctly recognized when connected to the PC.

1. After the installation from the CD-ROM is complete, power up the AD5764 evaluation board as described in the Power Supplies section. Then, connect it to the USB port of your PC using the supplied cable.
2. When the evaluation board is detected, proceed through any dialog boxes that appear. This finishes the installation.

## SOFTWARE OPERATION

To launch the software, select the **AD5764** submenu from the **Analog Devices** menu. Next, click **AD5764 Evaluation Software**. Figure 2 displays the main window.

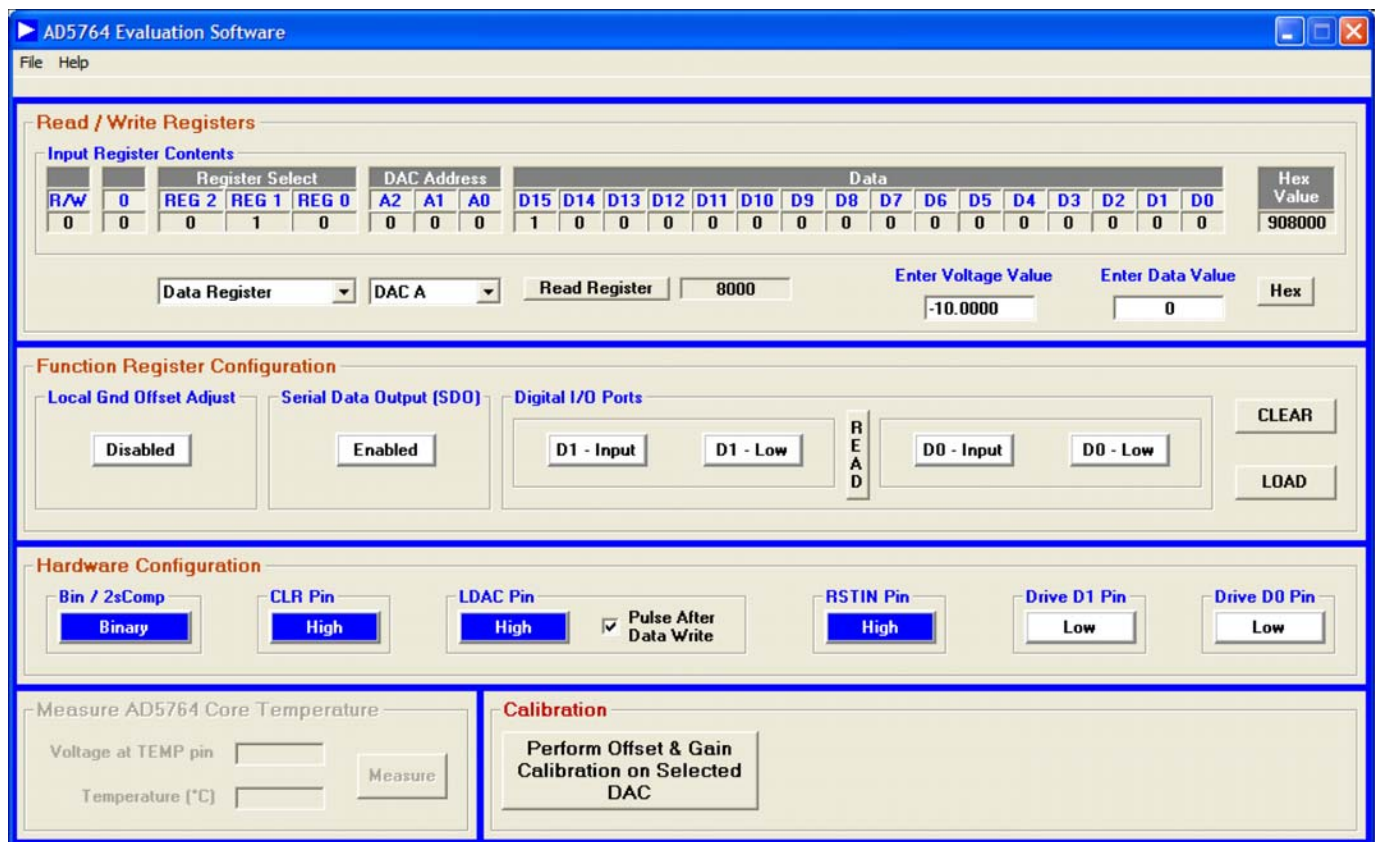

Figure 2. Main Window

This window is divided into five sections: **Read/Write Registers**, **Function Register Configuration**, **Hardware Configuration**, **Measure AD5764 Core Temperature** and **Calibration**.

## Read/Write Registers

The **Read/Write Registers** section allows you to write a value to—or read a value from—all of the AD5764 registers. The logic values of all bits in the input register are also displayed. Access to the registers is via two drop-down boxes. The first drop-down box lets you select the required register, and the second drop-down box lets you select one of the four DAC channels. In the case of the function register, the second drop-down box is not available. Depending on the register selected, either another drop-down box (if coarse gain register is selected) or a text box is displayed. For instance, to write to the data register of DAC C, select **Data Register** from the first drop-down box and **DAC C** from the second drop-down box. Two text boxes are now displayed where you can type a voltage value or a 16-bit data value (the toggle button to the right selects whether the entry is in hex or decimal). Clicking the **Enter** key completes the write operation.

## Calibration

The **Calibration** section allows you to remove any offset or gain errors that can exist on each of the DACs. The procedure to calibrate a DAC channel is as follows:

1. Select the DAC to be calibrated in the **Read/Write Registers** section.
2. In the **Calibration** section, click the **Perform Offset & Gain Calibration on Selected DAC** button. The calibration section display changes as shown in Figure 3.

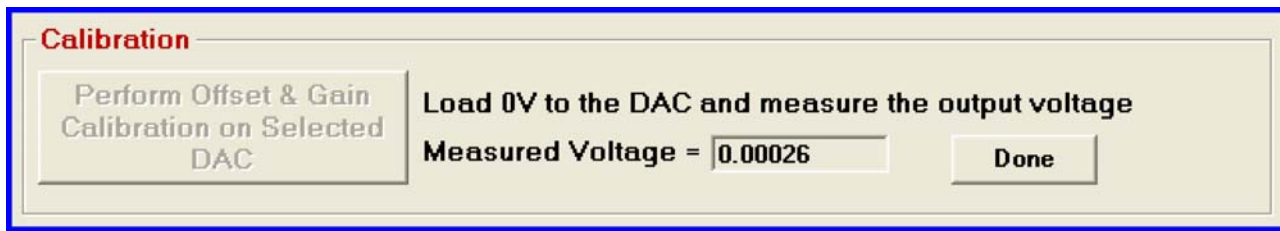

Figure 3.

3. In the **Read/Write Registers** section, load 0 V to the DAC and measure the output voltage of the DAC. Enter the measured value in the **Calibration** section. Click the **Done** button. The offset error should now have been reduced and the **Calibration** section displays changes as shown in Figure 4.

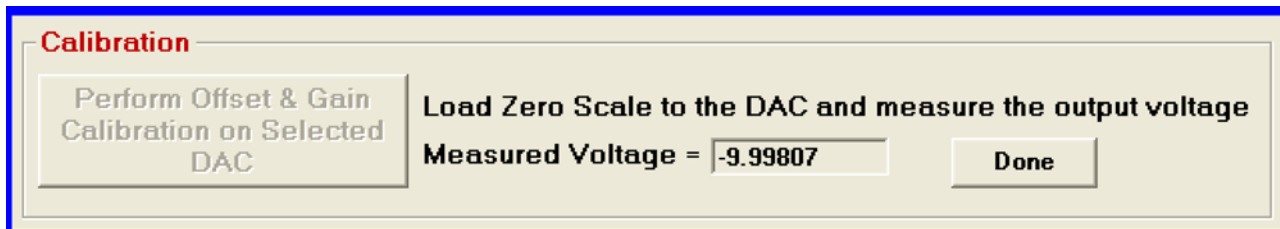

Figure 4.

4. In the **Read/Write Registers** section, load zero scale to the DAC (–10 V, –10.2564 V or –10.5263 V). Measure the output voltage of the DAC and enter the measured value in the **Calibration** section. Click the **Done** button. The gain error should now have been reduced.
5. Repeat this procedure for the other three DACs.

SCHEMATICS AND ARTWORK

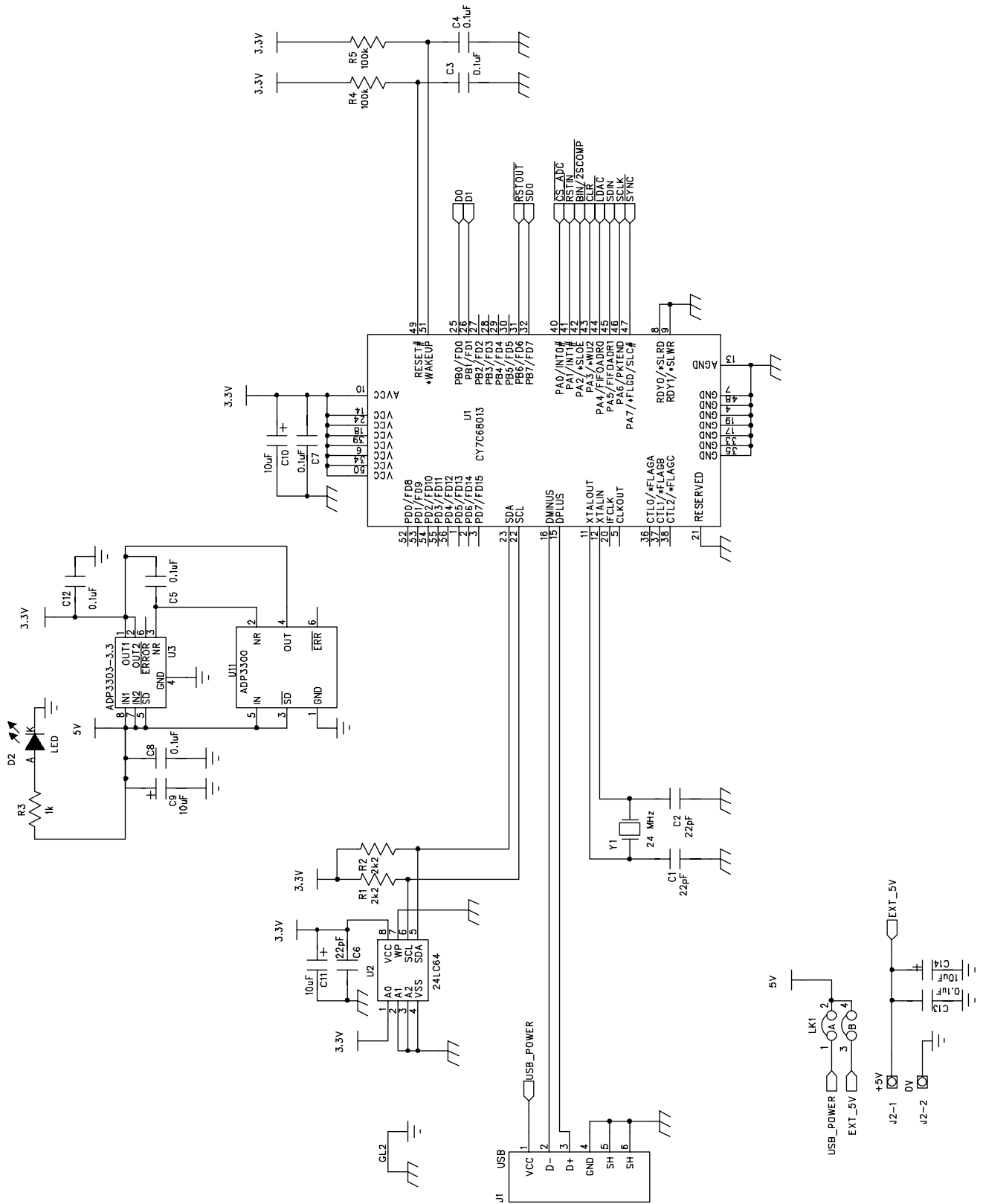
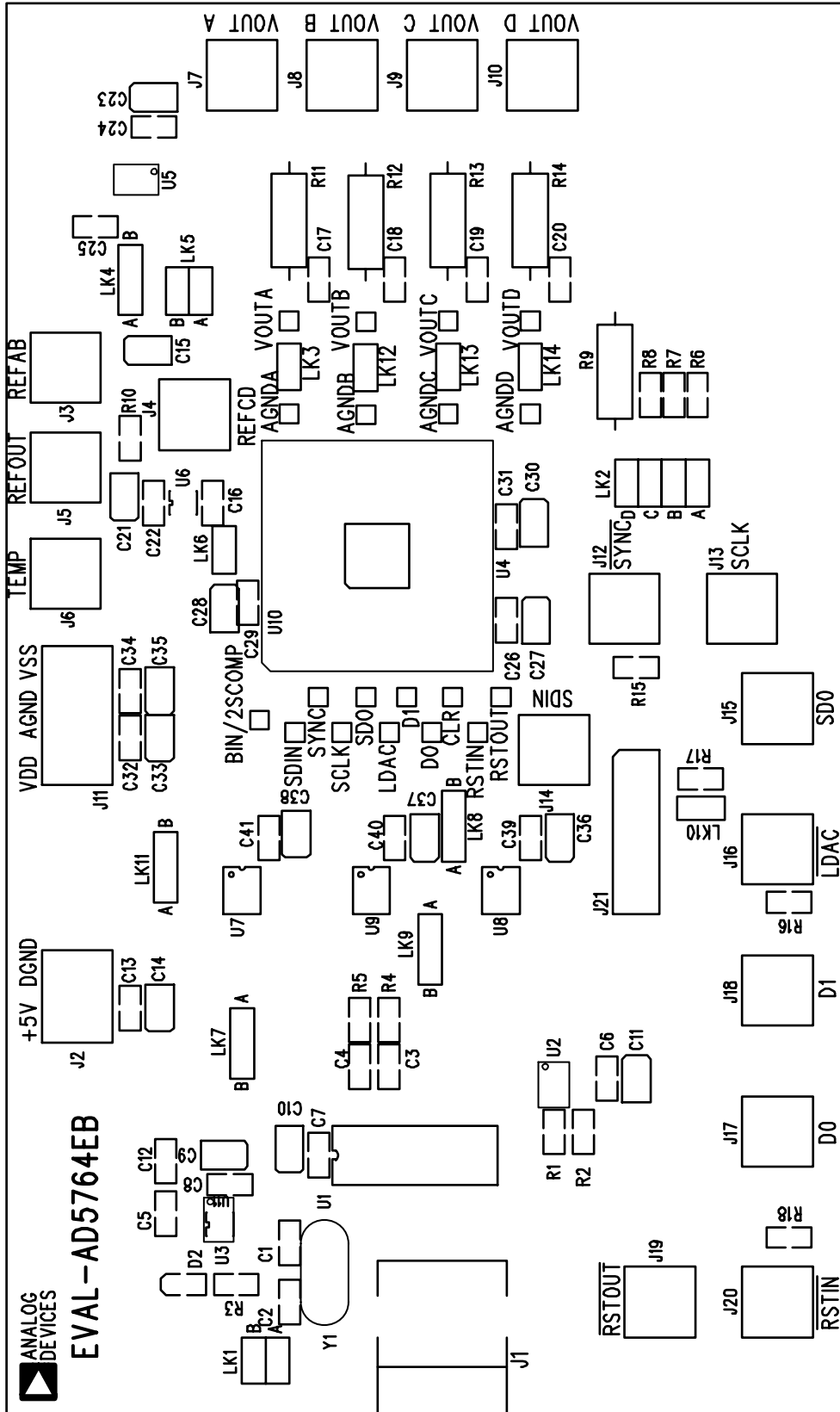

Figure 5. Schematic of Controller Circuitry







05961-007

Figure 7. Component Placement Drawing

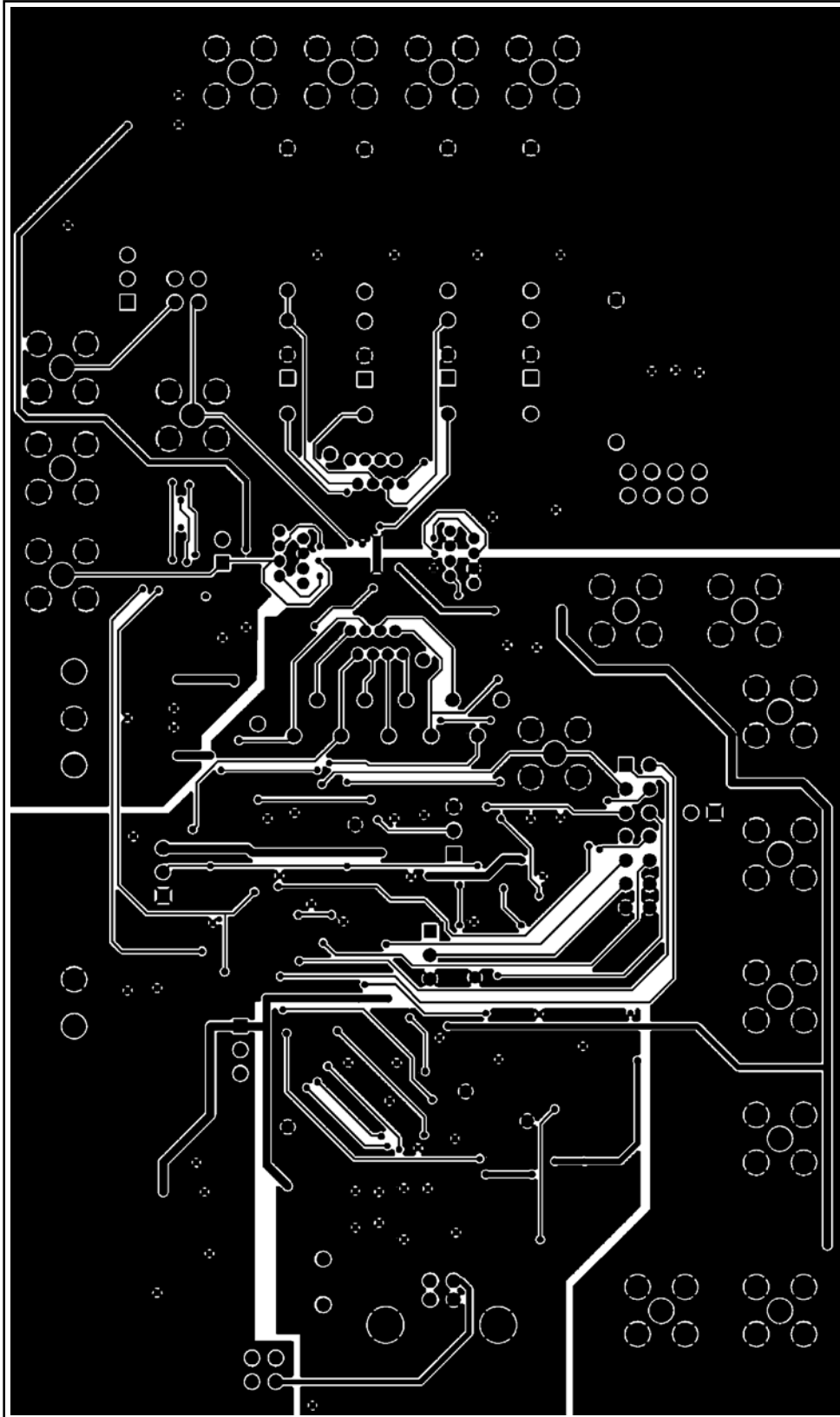

05967-008

Figure 8. Solder Side PCB Drawing

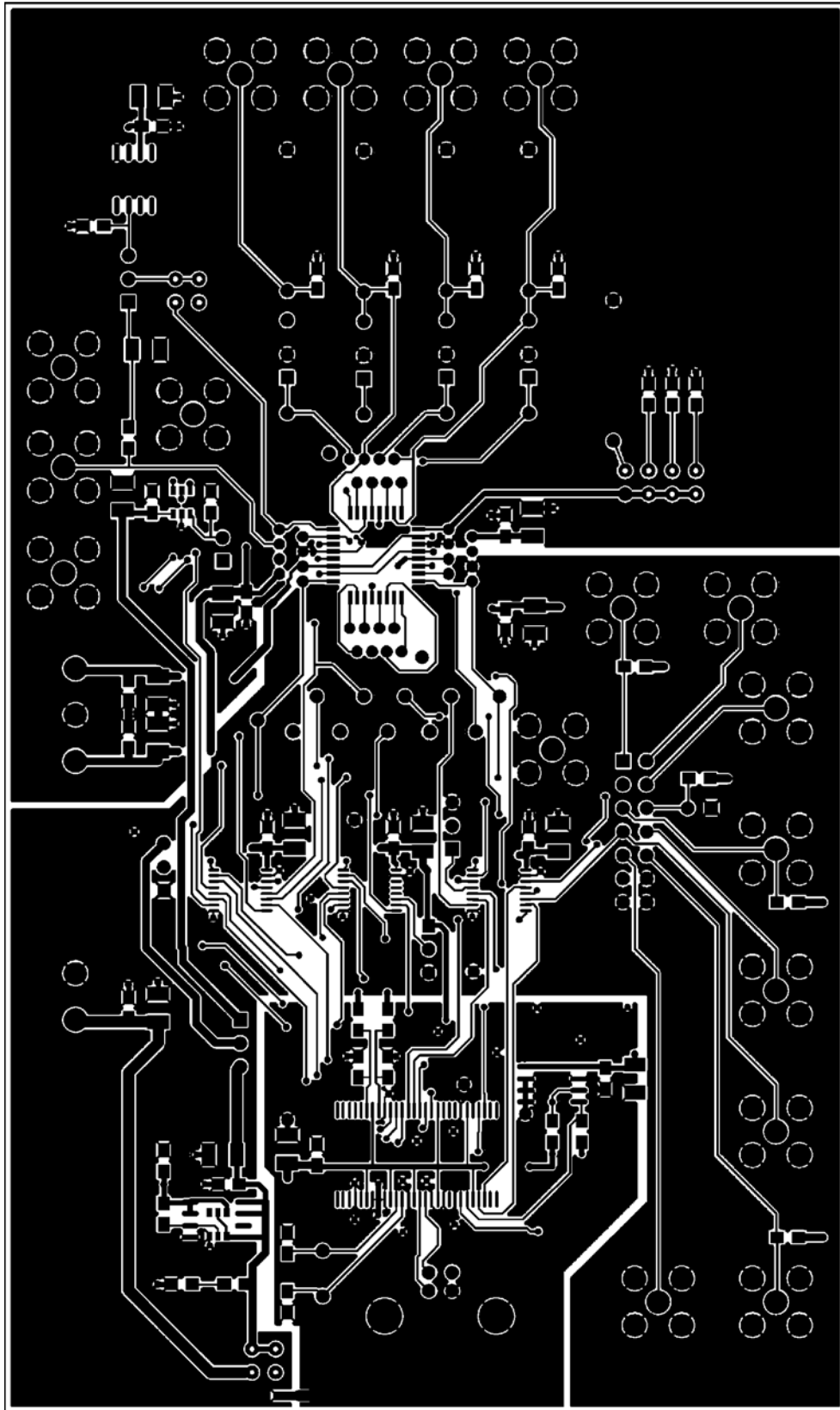

Figure 9. Component Side PCB Drawing

# EVAL-AD5764EB

## ORDERING INFORMATION

### BILL OF MATERIALS

Table 5.

Qty	Reference Designator	Description	Supplier/Number
1	U1	CY7C68013	Digikey 428-1332-ND
1	U2	24LC64	Digikey 24LC64-1/SN-ND
1	U3	<a href="#">ADP3303-3.3</a>	Analog Devices
1	U4	<a href="#">AD5764CSUZ</a>	Analog Devices
1	U5	<a href="#">ADRO2BR</a>	Analog Devices
1	U6	<a href="#">AD7476ART</a>	Analog Devices
3	U7, U8, U9	<a href="#">ADG774BRQ</a>	Analog Devices
1	U10	32-pin QFP socket	32QFP-SKT-OTQ-32-08-02
2	R1, R2	2.2 k $\Omega$ resistor 0805 package	FEC 911-896
1	R3	1 k $\Omega$ resistor 0805 package	FEC 554-005
2	R4, R5	100 k $\Omega$ resistor 0805 package	FEC 912-098
1	R6	120 k $\Omega$ resistor 0805 package	FEC 912-104
1	R7	56 k $\Omega$ resistor 0805 package	FEC 912-062
1	R8	6.2 k $\Omega$ resistor 0805 package	FEC 321-8156
1	R10	0 $\Omega$ resistor 0805 package	FEC 772-239
4	R15, R16, R17, R18	10 k $\Omega$ resistor 0805 package	FEC 911-975
3	C1, C2, C6	22 pF ceramic capacitor 0805 package	FEC 753-658
18	C3, C4, C5, C7, C8, C12, C13, C22, C24, C25, C26, C29, C31, C32, C34, C39, C40, C41	0.1 $\mu$ F ceramic capacitor 0805 package	FEC 317-287
15	C9, C10, C11, C14, C15, C21, C23, C27, C28, C30, C33, C35, C36, C37, C38	10 $\mu$ F tantalum capacitor TAJ_B package	FEC 498-737
1	C16	100 pF ceramic capacitor 0805 package	FEC 755-564
2	LK1, LK5	4-pin dil header & shorting link	FEC 148-535 & 150-411
1	LK2	8-pin dil header & shorting link	FEC 511-791 & 150-411
6	LK3, LK6, LK10, LK12, LK13, LK14	2-pin sil header & shorting link	FEC 511-705 & 150-411
5	LK4, LK7, LK8, LK9, LK11	3-pin sil header & shorting link	FEC 511-717 & 150-411
1	J1	USB receptacle B	FEC 152-754
1	J2	2-way screw terminal	FEC 151-785
17	J3 to J10, J12 to J20	Sub miniature BNC connector (SMB)	FEC 310-682
1	J11	3-way screw terminal	FEC 304-4890
1	J21	14-pin dil header	FEC 148-535
18	AGNDA, AGNDB, AGNDC, AGNDD, BIN/2sCOMP, CLR, D0, D1, RSTIN, LDAC, RSTOUT, SCLK, SDIN, SDO, SYNC, VOUTA, VOUTB, VOUTC, VOUTD	Testpoint	FEC 240-333
1	D2	LED 0805 package	FEC 359-9681
1	Y1	24 MHz crystal HC49 package	FEC 569-860

## ORDERING GUIDE

Model	Description
EVAL-AD5764EB	Evaluation Board

## ESD CAUTION

ESD (electrostatic discharge) sensitive device. Electrostatic charges as high as 4000 V readily accumulate on the human body and test equipment and can discharge without detection. Although this product features proprietary ESD protection circuitry, permanent damage may occur on devices subjected to high energy electrostatic discharges. Therefore, proper ESD precautions are recommended to avoid performance degradation or loss of functionality.

