

# MAX2686L / MAX2693L

## 内置LDO的 GPS/GNSS低噪声放大器

### 概述

MAX2686L/MAX2693L低噪声放大器(LNA)设计用于GPS L1波段以及Galileo、GLONASS应用。器件采用Maxim先进的SiGe工艺，在提供高增益、低噪声系数的同时，能够保持最优异的输入参考1dB压缩点和三阶截点指标。两款器件内部均集成了LDO，以支持电池供电系统。MAX2693L在仅仅消耗1.8mA电流的同时，能够保持出色的性能指标，非常适合对电流损耗敏感的应用。

器件采用+1.6V至+4.2V单电源供电，可选择的关断模式使器件电源电流降至20 $\mu$ A以下。器件采用超小尺寸、无铅并符合RoHS标准的0.86mm x 0.86mm x 0.65mm晶片级封装(WLP)。

### 应用

汽车导航  
 远程信息处理(物品跟踪和库存管理)  
 带有GPS的蜂窝电话  
 笔记本PC/超便携移动PC  
 娱乐终端、航海导航  
 手表  
 数码相机

### 特性

- ◆ 高功率增益：19dB (MAX2686L)
- ◆ 低噪声系数：0.88dB (MAX2686L)
- ◆ 集成50 $\Omega$ 输出匹配电路
- ◆ 低电源电流：1.8mA (MAX2693L)
- ◆ 较宽的电源电压范围：1.6V至4.2V
- ◆ 较少的材料清单：1个电感、2个电容
- ◆ 小尺寸封装：0.86mm x 0.86mm
- ◆ 0.4mm焊球间距的WLP封装

[订购信息](#)在数据资料的最后给出。

### 典型工作电路

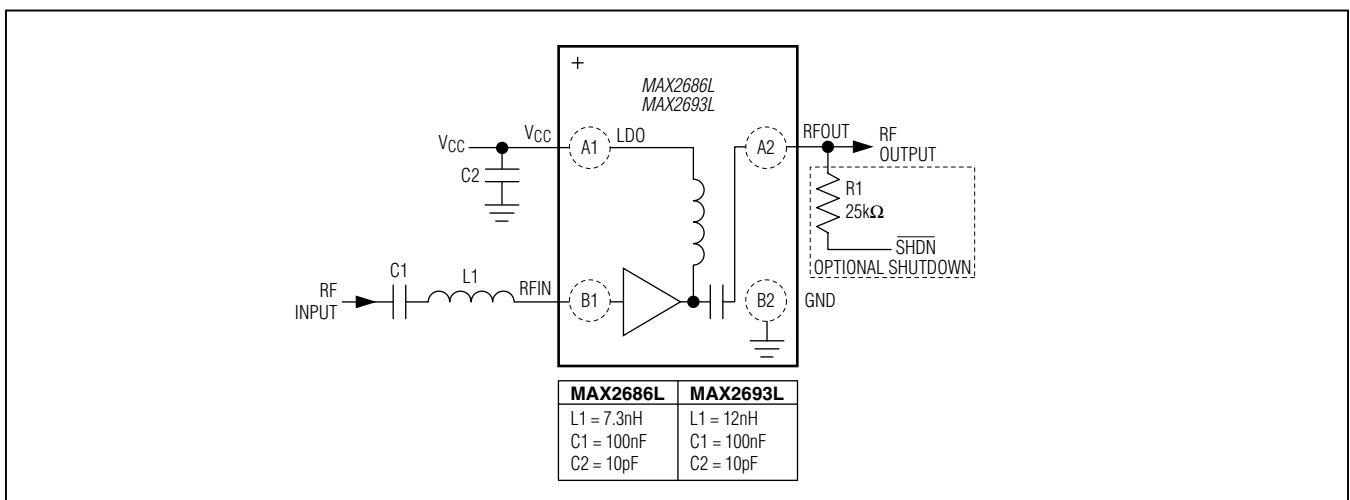

本文是英文数据资料的译文，文中可能存在翻译上的不准确或错误。如需进一步确认，请在您的设计中参考英文资料。有关价格、供货及订购信息，请联络Maxim亚洲销售中心：10800 852 1249 (北中国区)，10800 152 1249 (南中国区)，或访问Maxim的中文网站：[china.maximintegrated.com](http://china.maximintegrated.com)。

# MAX2686L / MAX2693L

## 內置LDO的 GPS/GNSS低噪声放大器

### ABSOLUTE MAXIMUM RATINGS

V <sub>CC</sub> to GND.....	-0.3V to +4.2V	Maximum Current into RF Input .....	10mA
Other Pins to GND .....	-0.3V to (+ Operating V <sub>CC</sub> + 0.3V)	Operating Temperature Range .....	-40°C to +85°C
Maximum RF Input Power .....	+5dBm	Junction Temperature .....	+150°C
Continuous Power Dissipation (T <sub>A</sub> = +70°C)		Storage Temperature Range.....	-65°C to +160°C
WLP (derates 9.7mW/°C above +70°C) .....	776mW	Soldering Temperature (reflow) (Note 1) .....	+260°C

**Note 1:** Refer to Application Note 1891: *Wafer-Level Packaging (WLP) and Its Applications*.

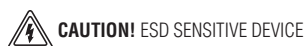

Stresses beyond those listed under "Absolute Maximum Ratings" may cause permanent damage to the device. These are stress ratings only, and functional operation of the device at these or any other conditions beyond those indicated in the operational sections of the specifications is not implied. Exposure to absolute maximum rating conditions for extended periods may affect device reliability.

### DC ELECTRICAL CHARACTERISTICS

(MAX2686L/MAX2693L EV kit, V<sub>CC</sub> = 1.6V to 4.2V, T<sub>A</sub> = -40°C to +85°C, no RF signals are applied. Typical values are at V<sub>CC</sub> = 3.3V and T<sub>A</sub> = +25°C, unless otherwise noted.) (Note 2)

PARAMETER	CONDITIONS	MIN	TYP	MAX	UNITS
Supply Voltage		1.6	3.3	4.2	V
Supply Current	SHDN = high	MAX2686L	5		mA
		MAX2693L	1.8		
	Shutdown mode, V <sub>SHDN</sub> = 0V				20
Digital Input Logic-High	(Note 3)	1.2			V
Digital Input Logic-Low	(Note 3)			0.45	V

### AC ELECTRICAL CHARACTERISTICS

(MAX2686L/MAX2693L EV kit, V<sub>CC</sub> = 1.6V to 4.2V, T<sub>A</sub> = -40°C to +85°C, f<sub>RFIN</sub> = 1575.42MHz. Typical values are at V<sub>CC</sub> = 3.3V and T<sub>A</sub> = +25°C, unless otherwise noted.) (Note 2)

PARAMETER	CONDITIONS	MIN	TYP	MAX	UNITS
RF Frequency	L1 band		1575.42		MHz
Power Gain	V <sub>CC</sub> = 4.2V (Note 4)	MAX2686L	14.65	19.0	dB
		MAX2693L	11.6	18.4	
	V <sub>CC</sub> = 1.6V	MAX2686L	14.85	19.1	
		MAX2693L	11.6	18.7	
Noise Figure	V <sub>CC</sub> = 1.6V to 4.2V	MAX2686L	0.88		dB
		MAX2693L	1.05		
In-Band 3rd-Order Input Intercept Point	(Note 5)	MAX2686L	-4.1		dBm
		MAX2693L	-14.3		
Out-of-Band 3rd-Order Input Intercept Point	(Note 6)	MAX2686L	-0.1		dBm
		MAX2693L	-13.9		
Input 1dB Compression Point	(Note 7)	MAX2686L	-12.1		dBm
		MAX2693L	-11.0		
Input Return Loss	MAX2686L		11.2		dB
	MAX2693L		10.7		

# MAX2686L / MAX2693L

## 内置LDO的 GPS/GNSS低噪声放大器

### AC ELECTRICAL CHARACTERISTICS (continued)

(MAX2686L/MAX2693L EV kit,  $V_{CC} = 1.6V$  to  $4.2V$ ,  $T_A = -40^{\circ}C$  to  $+85^{\circ}C$ ,  $f_{RFIN} = 1575.42MHz$ . Typical values are at  $V_{CC} = 3.3V$  and  $T_A = +25^{\circ}C$ , unless otherwise noted.) (Note 2)

PARAMETER	CONDITIONS	MIN	TYP	MAX	UNITS
Output Return Loss	MAX2686L		22.0		dB
	MAX2693L		14.3		
Reverse Isolation	MAX2686L		41.0		dB
	MAX2693L		40.0		

**Note 2:** Min and max limits guaranteed by test at  $T_A = +25^{\circ}C$  and guaranteed by design and characterization at  $T_A = -40^{\circ}C$  and  $T_A = +85^{\circ}C$ , unless otherwise noted.

**Note 3:** Min and max limits guaranteed by test at  $T_A = +25^{\circ}C$ .

**Note 4:** Min limit guaranteed by design and characterization.

**Note 5:** Measured with the two tones located at 1MHz and 2MHz offset from the center of the GPS band with -30dBm/tone.

**Note 6:** Measured with input tones at 1713MHz (-27dBm) and 1851MHz (-39dBm).

**Note 7:** Measured with a tone located at the center of the GPS band.

### 典型工作特性

(MAX2686L/MAX2693L EV kit. Typical values are at  $V_{CC} = 3.3V$ ,  $T_A = +25^{\circ}C$ , and  $f_{RFIN} = 1575.42MHz$ , unless otherwise noted.)

### MAX2686L

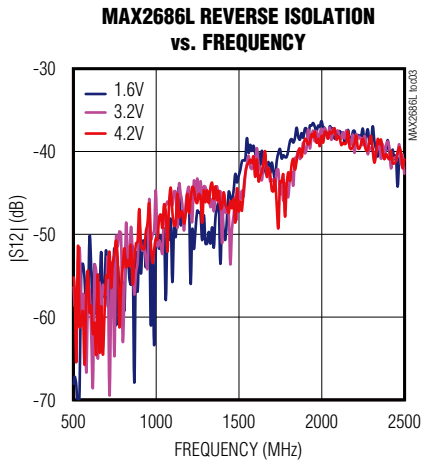
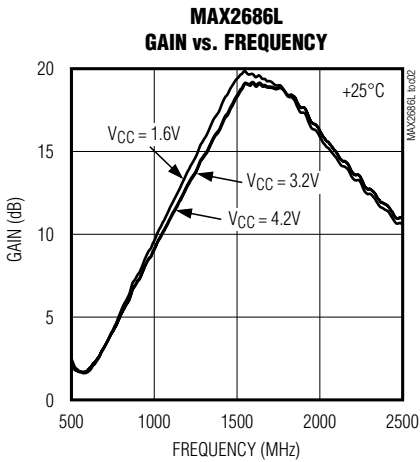
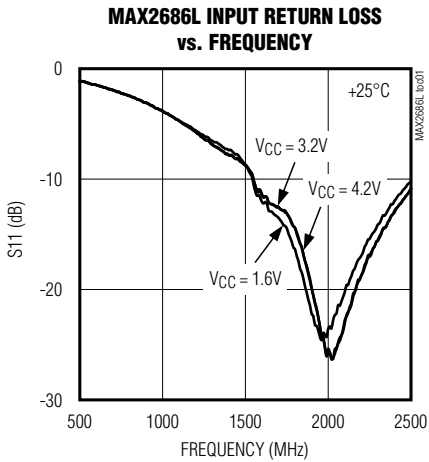

# MAX2686L / MAX2693L

## 内置LDO的 GPS/GNSS低噪声放大器

典型工作特性(续)

(MAX2686L/MAX2693L EV kit. Typical values are at  $V_{CC} = 2.85V$ ,  $T_A = +25^\circ C$ , and  $f_{RFIN} = 1575.42MHz$ , unless otherwise noted.)

### MAX2686L

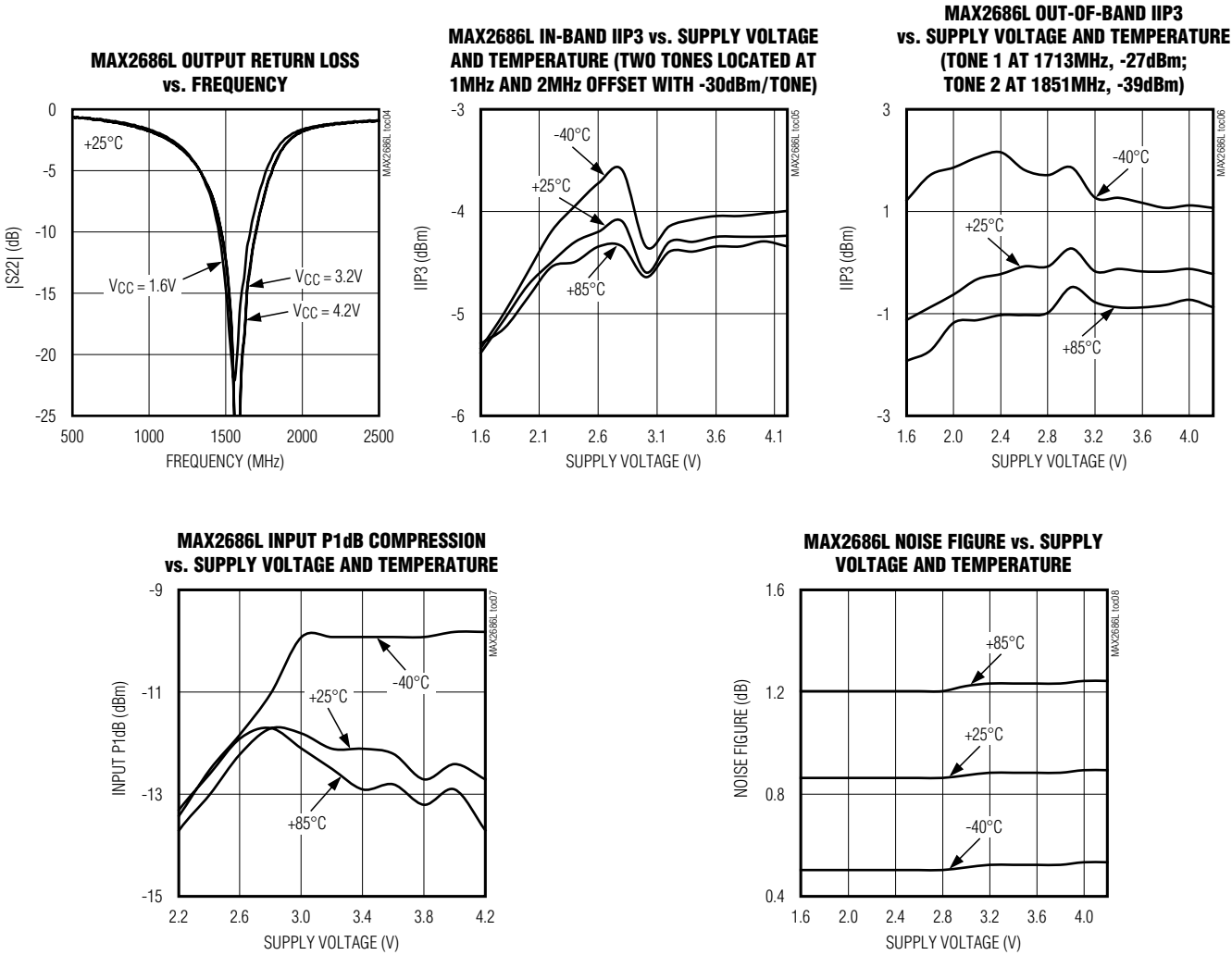

# MAX2686L / MAX2693L

## 内置LDO的 GPS/GNSS低噪声放大器

典型工作特性(续)

(MAX2686L/MAX2693L EV kit. Typical values are at  $V_{CC} = 2.85V$ ,  $T_A = +25^\circ C$ , and  $f_{RFIN} = 1575.42MHz$ , unless otherwise noted.)

### MAX2693L

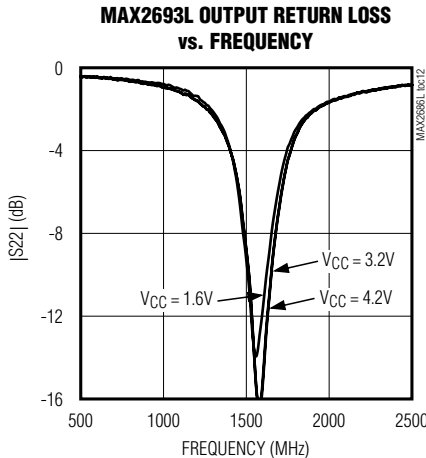
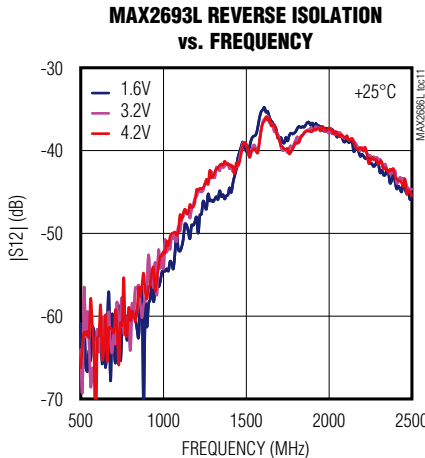
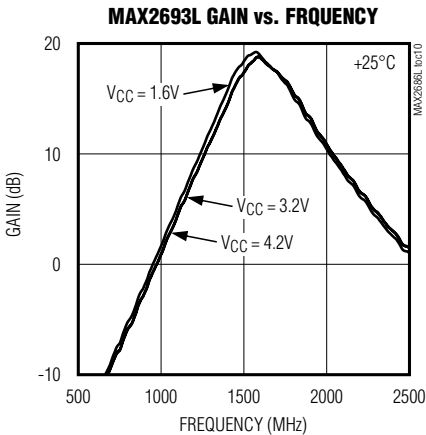
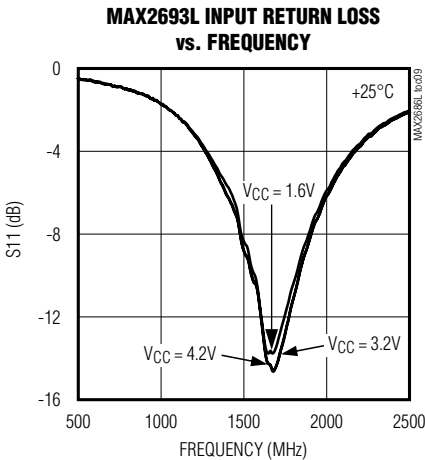

# MAX2686L / MAX2693L

## 内置LDO的 GPS/GNSS低噪声放大器

典型工作特性(续)

(MAX2686L/MAX2693L EV kit. Typical values are at  $V_{CC} = 2.85V$ ,  $T_A = +25^\circ C$ , and  $f_{RFIN} = 1575.42MHz$ , unless otherwise noted.)

### MAX2693L

**MAX2693L IN-BAND IIP3 vs. SUPPLY VOLTAGE AND TEMPERATURE  
(TWO TONES LOCATED AT 1MHz AND 2MHz OFFSET WITH -30dBm/TONE)**

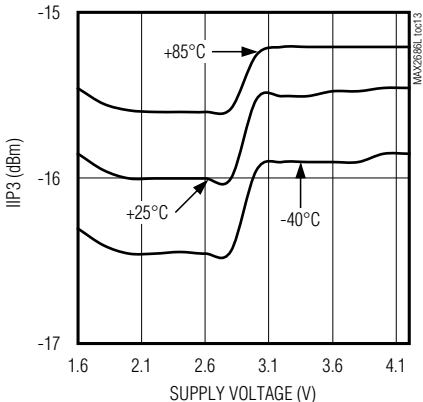

**MAX2693L OUT-OF-BAND IIP3 vs. SUPPLY VOLTAGE AND TEMPERATURE  
(TONE 1 AT 1713MHz, -27dBm; TONE 2 AT 1851MHz, -39dBm)**

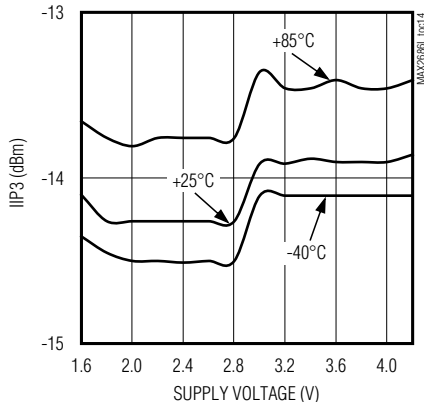

**MAX2693L INPUT P1dB COMPRESSION vs. SUPPLY VOLTAGE AND TEMPERATURE**

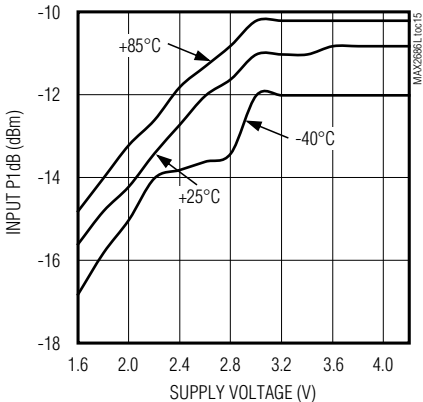

**MAX2693L NOISE FIGURE vs. SUPPLY VOLTAGE AND TEMPERATURE**

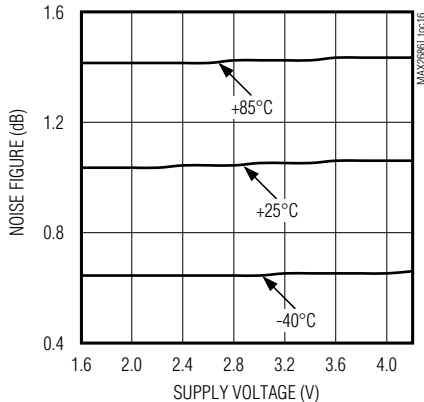

# MAX2686L / MAX2693L

## 内置LDO的 GPS/GNSS低噪声放大器

### 焊球配置

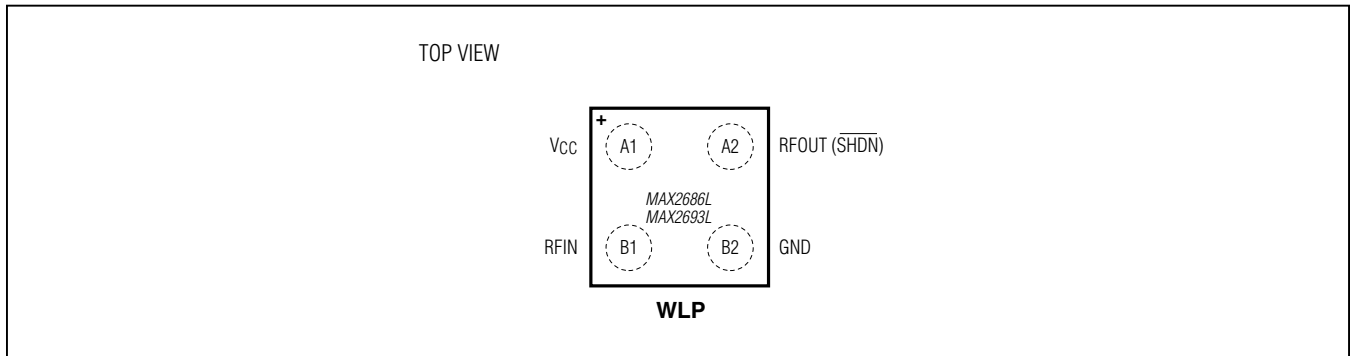

### 焊球说明

焊球	名称	功能
A1	V <sub>CC</sub>	电源电压，通过10pF电容旁路至地，电容应尽量靠近IC放置。
A2	RFOUT (SHDN)	RF输出/SHDN输入。RFOUT在内部匹配至50Ω并通过1MΩ电阻上拉到V <sub>CC</sub> 。SHDN与RFOUT共用一个焊球，默认状态下，一旦V <sub>CC</sub> 施加电源将立即进入有效工作模式；可从外部通过一个25kΩ电阻将RFOUT (SHDN)拉至直流低电平，关断IC。
B1	RFIN	RF输入，需要外部连接隔直流电容和匹配元件。
B2	GND	地，连接到PCB地层。

### 详细说明

MAX2686L/MAX2693L是针对GPS L1、Galileo和GLONASS应用设计的LNA。器件具有可选择的电源关断控制模式，无需外部电源开关。器件以超小尺寸封装提供高增益和低噪声系数，理想用于空间敏感设计。这些IC无需外部LDO。

#### 输入和输出匹配

器件需要外部输入匹配电路，只需一个电感与隔直流电容串联，即可构建输入匹配电路。[典型工作电路](#)给出了所推荐的输入匹配网络。这些数值同时优化于最佳增益、噪声系数、回波损耗等性能指标。输入耦合电容会影响IIP3，

选择较小的耦合电容时将产生较低的IIP3。器件内部集成了50Ω输出匹配电路，无需外部匹配元件。[表1](#)和[表2](#)列出了器件的典型S参数和K<sub>f</sub>系数，典型噪声参数如[表3](#)和[表4](#)所示。

#### 关断

器件包含关断功能，用于关断整个芯片的工作。由于器件内部，RFOUT (与SHDN输入共用同一焊球)通过上拉电阻拉至V<sub>CC</sub>，默认条件下，一旦V<sub>CC</sub>施加电源，器件将立即进入有效工作模式；通过一个适当的外部电阻(例如：25kΩ)，在RFOUT端作用一个低电平关断器件，避免器件在有效工作期间给RF输出信号增加负载。

# MAX2686L / MAX2693L

## 内置LDO的 GPS/GNSS低噪声放大器

表1. MAX2686L的典型S参数和K系数

FREQ (MHz)	S11 MAG (dB)	S11 PHASE (DEGREES)	S21 MAG (dB)	S21 PHASE (DEGREES)	S12 MAG (dB)	S12 PHASE (DEGREES)	S22 MAG (dB)	S22 PHASE (DEGREES)	K <sub>f</sub>
1000	-2.7	-88.3	7.9	162.0	-56.7	101.9	-1.9	-153.8	16.1
1100	-2.9	-95.0	9.6	150.5	-48.5	57.5	-2.4	-169.9	9.8
1200	-3.2	-101.7	11.2	136.9	-45.5	64.8	-3.1	172.8	7.4
1300	-3.4	-107.4	12.8	122.2	-49.2	51.0	-4.4	153.8	6.6
1400	-3.5	-113.3	14.4	104.8	-47.4	1.8	-6.8	132.5	6.9
1500	-3.3	-120.2	16.0	85.4	-50.7	19.3	-11.9	102.3	7.8
1575	-3.5	-125.7	16.8	66.9	-44.6	29.9	-26.0	46.7	5.9
1600	-3.7	-126.8	16.8	58.4	-43.4	15.5	-24.3	-79.5	5.1
1700	-3.6	-131.1	16.5	34.7	-49.8	-7.5	-10.1	-125.4	6.5
1800	-3.5	-139.0	16.1	12.9	-51.0	39.5	-5.4	-148.1	4.0
1900	-3.7	-146.3	15.2	-7.7	-41.9	7.5	-3.0	-169.7	2.2
2000	-4.0	-152.0	13.8	-24.4	-41.8	-10.7	-1.9	170.5	2.0

表2. MAX2693L的典型S参数和K系数

FREQ (MHz)	S11 MAG (dB)	S11 PHASE (DEGREES)	S21 MAG (dB)	S21 PHASE (DEGREES)	S12 MAG (dB)	S12 PHASE (DEGREES)	S22 MAG (dB)	S22 PHASE (DEGREES)	K <sub>f</sub>
1000	-1.0	-77.4	-2.5	-148.6	-55.5	78.6	-0.9	-138.2	16.1
1100	-1.1	-84.8	0.1	-159.7	-51.0	85.5	-1.2	-154.2	9.8
1200	-1.2	-92.5	2.7	-172.2	-48.0	70.0	-1.6	-172.0	7.4
1300	-1.3	-99.4	5.6	171.7	-46.4	56.0	-2.3	167.2	6.6
1400	-1.5	-106.5	8.4	152.1	-45.9	35.6	-3.8	140.1	6.9
1500	-1.6	-113.2	11.0	124.7	-46.3	22.2	-8.0	96.8	7.8
1575	-1.6	-118.5	12.2	99.5	-44.0	38.3	-14.8	23.5	5.9
1600	-1.7	-120.6	12.3	88.4	-42.4	22.2	-14.9	-33.4	5.1
1700	-1.9	-126.6	11.5	55.8	-45.3	-9.5	-6.5	-117.5	6.5
1800	-1.8	-133.6	10.0	30.2	-43.6	12.4	-3.3	-152.3	4.0
1900	-2.0	-140.7	8.4	10.0	-40.1	-8.1	-2.0	-176.5	2.2
2000	-2.1	-146.9	6.9	-4.9	-39.6	-29.9	-1.5	164.9	2.0

表3. MAX2686L的仿真噪声参数典型值(V<sub>CC</sub> = 3.3V, T<sub>A</sub> = +25°C)

FREQUENCY (MHz)	FMIN (dB)	Γ <sub>OPT</sub>	Γ <sub>OPT</sub>   ANGLE	R <sub>N</sub> (Ω)
1550	0.70	0.43	45	8.45
1560	0.70	0.43	45	8.43
1570	0.70	0.42	45	8.42
1580	0.70	0.42	45	8.41
1590	0.70	0.42	46	8.39
1600	0.71	0.42	46	8.38



# MAX2686L / MAX2693L

## 内置LDO的 GPS/GNSS低噪声放大器

表4. MAX2693L的仿真噪声参数典型值( $V_{CC} = 3.3V$ ,  $T_A = +25^\circ C$ )

FREQUENCY (MHz)	FMIN (dB)	$ Γ_{OPT} $	$ Γ_{OPT} $ ANGLE	$R_N$ ( $\Omega$ )
1550	0.88	0.69	32	24.27
1560	0.88	0.69	32	24.22
1570	0.88	0.68	32	24.17
1580	0.88	0.68	32	24.12
1590	0.88	0.68	32	24.07
1600	0.88	0.68	33	24.03

### 应用信息

合理设计PCB是任何RF微波电路设计的基础，在所有高频输入和输出端采用阻抗受控引线。利用去耦电容旁路 $V_{CC}$ ，电容应尽可能靠近器件放置。 $V_{CC}$ 引线较长时，可能需要增加去耦电容，这些增添的电容可远离器件放置。GND焊球采用适当的接地也非常重要，如果PCB的顶层为RF地，可以将GND焊球直接连接到该接地层。如果电路板的地不在元件层，则将GND焊球通过多个过孔连接到电路板地，过孔须尽量靠近器件。有关电路板布局的通用规则，请参考：[china.maximintegrated.com/app-notes/index.mvp/id/5100](http://china.maximintegrated.com/app-notes/index.mvp/id/5100)。

MAX2686L/MAX2693L的评估板原理图、Gerber文件、PADS布局文件以及BOM信息，请参考[china.maximintegrated.com/datasheet/index.mvp/id/6934/t/do](http://china.maximintegrated.com/datasheet/index.mvp/id/6934/t/do)。

### 订购信息

PART	TEMP RANGE	PIN-PACKAGE
MAX2686LEWS+T	-40°C to +85°C	4 WLP
MAX2693LEWS+T	-40°C to +85°C	4 WLP

+表示无铅(Pb)/符合RoHS标准的封装。  
T = 卷带包装。

### 芯片信息

PROCESS: SiGe BiCMOS

### 封装信息

如需最近的封装外形信息和焊盘布局(占位面积)，请查询[china.maximintegrated.com/package](http://china.maximintegrated.com/package)。请注意，封装编码中的“+”、“#”或“-”仅表示RoHS状态。封装图中可能包含不同的尾缀字符，但封装图只与封装有关，与RoHS状态无关。

封装类型	封装编码	外形编号	焊盘布局编号
4 WLP	W40A0+1	<a href="#">21-0480</a>	参见 <a href="#">应用笔记1891</a>

# MAX2686L / MAX2693L

## 内置LDO的 GPS/GNSS低噪声放大器

### 修订历史

修订号	修订日期	说明	修改页
0	3/12	最初版本。	—

### Maxim北京办事处

北京8328信箱 邮政编码100083

免费电话: 800 810 0310

电话: 010-6211 5199

传真: 010-6211 5299



Maxim不对Maxim产品以外的任何电路使用负责，也不提供其专利许可。Maxim保留在任何时间、没有任何通报的前提下修改产品资料和规格的权利。电气特性表中列出的参数值(最小值和最大值)均经过设计验证，数据资料其它章节引用的参数值供设计人员参考。

**Maxim Integrated 160 Rio Robles, San Jose, CA 95134 USA 1-408-601-10 00**

**10**

© 2012 Maxim Integrated

Maxim标志和Maxim Integrated是Maxim Integrated Products, Inc.的商标。