

高线性度、815MHz至1000MHz 上变频/下变频混频器，带有LO缓冲器/开关

概述

MAX2029高线性度、无源上变频/下变频混频器在815MHz至1000MHz的RF频率范围内具有+36.5dBm IIP3、6.7dB NF和6.5dB变频损耗，支持GSM/蜂窝基站发送器或接收器应用。该混频器的LO频率范围为570MHz至900MHz，非常适合低端LO注入结构。关于引脚兼容的高端LO注入混频器，请参考MAX2031数据资料。

MAX2029不仅具有出色的线性度和噪声指标，还具有非常高的集成度。器件包括：一个双平衡无源混频器核、双输入LO选择开关和LO缓冲器。片内还集成了非平衡变压器，用于下变频器的单端RF输入(或上变频器的RF输出)以及单端LO输入的转换器。MAX2029需要标称值为0dBm的LO驱动，电源电流保证小于100mA。

MAX2029与MAX2039、MAX2041、MAX2042和MAX2044系列的1700MHz至2200MHz、2000MHz至3000MHz和3200MHz至3900MHz混频器引脚兼容，使用该系列无源上变频器和下变频器能够在相同的印刷电路板(PCB)上实现多频段通信方案。

MAX2029采用紧凑的20引脚、薄型QFN封装(5mm x 5mm)，带有裸焊盘，工作在-40°C至+85°C扩展级温度范围。

应用

蜂窝频段WCDMA和
cdma2000®基站
GSM 850/GSM 900 2G和
2.5G EDGE基站
TDMA和集成数字增强网
络(iDEN®)基站
PHS/PAS基站
WiMAX基站和企业设备

预失真接收器
微波和固定带宽无线接
入设备
无线本地环路
个人移动无线装置
军用系统
微波链路
数字与扩频通信系统

cdma2000是Telecommunications Industry Association的注册商标。
iDEN是Motorola, Inc.的注册商标。

特性

- ◆ 815MHz至1000MHz RF频率范围
- ◆ 570MHz至900MHz LO频率范围
- ◆ 960MHz至1180MHz LO频率范围(参考MAX2031数据资料)
- ◆ 直流至250MHz IF频率范围
- ◆ 6dB/6.5dB变频损耗(上变频器/下变频器)
- ◆ 36.5dBm/39dBm输入IP3 (下变频器/上变频器)
- ◆ +25dBm/+27dBm输入1dB压缩点(上变频器/下变频器)
- ◆ 6.7dB噪声系数
- ◆ 集成LO缓冲器
- ◆ 集成RF和LO非平衡变压器
- ◆ -3dBm至+3dBm低LO驱动
- ◆ 内置SPDT LO开关，具有53dB隔离和50ns开关时间
- ◆ 引脚兼容于1700MHz至2200MHz混频器MAX2039/MAX2041
- ◆ 可通过外部电阻设置电流，提供混频器的低功耗/低性能工作模式选项
- ◆ 提供无铅封装

订购信息

PART	TEMP RANGE	PIN-PACKAGE	PKG CODE
MAX2029ETP/-T	-40°C to +85°C	20 Thin QFN-EP* (5mm x 5mm)	T2055-3
MAX2029ETP/+T	-40°C to +85°C	20 Thin QFN-EP* (5mm x 5mm)	T2055-3

T = 卷带包装。

*EP = 裸焊盘。

+表示无铅封装。

引脚配置/功能框图

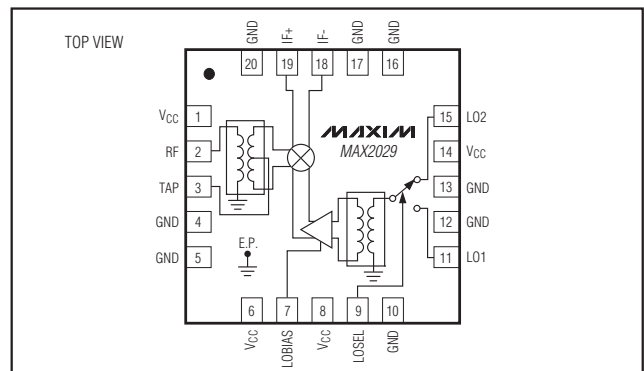

高线性度、815MHz至1000MHz 上变频/下变频混频器，带有LO缓冲器/开关

ABSOLUTE MAXIMUM RATINGS

V _{CC} to GND	-0.3V to +5.5V	Continuous Power Dissipation (T _C = +85°C) (Note A)
RF (RF is DC shorted to GND through a balun)	50mA	20-Pin Thin QFN-EP
LO1, LO2 to GND	-0.3V to +0.3V	θ _{JA} (Note B)
IF+, IF- to GND	-0.3V to (V _{CC} + 0.3V)	θ _{JC}
TAP to GND	-0.3V to +1.4V	Operating Temperature Range (Note C)T _C = -40°C to +85°C
LOSEL to GND	-0.3V to (V _{CC} + 0.3V)	Maximum Junction Temperature
LOBIAS to GND	-0.3V to (V _{CC} + 0.3V)	Storage Temperature Range
RF, LO1, LO2 Input Power*	+20dBm	Lead Temperature (soldering, 10s)

Note A: Based on junction temperature $T_J = T_C + (\theta_{JC} \times V_{CC} \times I_{CC})$. This formula can be used when the temperature of the exposed paddle is known while the device is soldered down to a PCB. See the *Applications Information* section for details. The junction temperature must not exceed +150°C.

Note B: Junction temperature $T_J = T_A + (\theta_{JA} \times V_{CC} \times I_{CC})$. This formula can be used when the ambient temperature of the EV kit PCB is known. The junction temperature must not exceed +150°C. See the *Applications Information* section for details.

Note C: T_C is the temperature on the exposed paddle of the package. T_A is the ambient temperature of the device and PCB.

*Maximum reliable continuous input power applied to the RF, LO, and IF ports of this device is +15dBm from a 50Ω source.

Stresses beyond those listed under "Absolute Maximum Ratings" may cause permanent damage to the device. These are stress ratings only, and functional operation of the device at these or any other conditions beyond those indicated in the operational sections of the specifications is not implied. Exposure to absolute maximum rating conditions for extended periods may affect device reliability.

DC ELECTRICAL CHARACTERISTICS

(Typical Application Circuit, V_{CC} = +4.75V to +5.25V, no RF signals applied, T_C = -40°C to +85°C. IF+ and IF- are DC grounded through an IF balun. Typical values are at V_{CC} = +5V, T_C = +25°C, unless otherwise noted.)

PARAMETER	SYMBOL	CONDITIONS	MIN	TYP	MAX	UNITS
Supply Voltage	V _{CC}		4.75	5.00	5.25	V
Supply Current	I _{CC}			85	100	mA
LOSEL Input Logic-Low	V _{IL}				0.8	V
LOSEL Input Logic-High	V _{IH}		2			V
Input Current	I _{IH} , I _{IL}			±0.01		μA

AC ELECTRICAL CHARACTERISTICS

(Typical Application Circuit, C5 = 3.3pF, L1 and C4 not used, V_{CC} = +4.75V to +5.25V, RF and LO ports are driven from 50Ω sources, P_{LO} = -3dBm to +3dBm, P_{RF} = 0dBm, f_{RF} = 815MHz to 1000MHz, f_{LO} = 570MHz to 900MHz, f_{IF} = 90MHz, f_{LO} < f_{RF}, T_C = -40°C to +85°C, unless otherwise noted. Typical values are at V_{CC} = +5V, P_{LO} = 0dBm, f_{RF} = 920MHz, f_{LO} = 830MHz, f_{IF} = 90MHz, T_C = +25°C, unless otherwise noted.) (Note 1)

PARAMETER	SYMBOL	CONDITIONS	MIN	TYP	MAX	UNITS
RF Frequency Range	f _{RF}	(Note 2)	815		1000	MHz
LO Frequency Range	f _{LO}	(Note 2)	570		900	MHz
IF Frequency Range	f _{IF}	External IF transformer dependence (Note 2)	DC		250	MHz
LO Drive	P _{LO}	(Note 2)	-3		+3	dBm
LO1-to-LO2 Isolation (Note 3)		LO2 selected, P _{LO} = +3dBm, T _C = +25°C, f _{RF} = 920MHz to 960MHz, f _{LO} = 830MHz to 870MHz	48	53		dB
		LO1 selected, P _{LO} = +3dBm, T _C = +25°C, f _{RF} = 920MHz to 960MHz, f _{LO} = 830MHz to 870MHz	50	56		
Maximum LO Leakage at RF Port		P _{LO} = +3dBm		-17		dBm
Maximum LO Leakage at IF Port		P _{LO} = +3dBm, f _{RF} = 920MHz to 960MHz, f _{LO} = 830MHz to 870MHz (Note 3)		-29.5	-23	dBm

高线性度、815MHz至1000MHz 上变频/下变频混频器，带有LO缓冲器/开关

MAX2029

AC ELECTRICAL CHARACTERISTICS (continued)

(Typical Application Circuit, C5 = 3.3pF, L1 and C4 not used, V_{CC} = +4.75V to +5.25V, RF and LO ports are driven from 50Ω sources, P_{LO} = -3dBm to +3dBm, P_{RF} = 0dBm, f_{RF} = 815MHz to 1000MHz, f_{LO} = 570MHz to 900MHz, f_{IF} = 90MHz, f_{LO} < f_{RF}, T_C = -40°C to +85°C, unless otherwise noted. Typical values are at V_{CC} = +5V, P_{LO} = 0dBm, f_{RF} = 920MHz, f_{LO} = 830MHz, f_{IF} = 90MHz, T_C = +25°C, unless otherwise noted.) (Note 1)

PARAMETER	SYMBOL	CONDITIONS	MIN	TYP	MAX	UNITS
LO Switching Time		50% of LOSEL to IF, settled within 2 degrees		50		ns
Minimum RF-to-IF Isolation		f _{RF} = 920MHz to 960MHz, f _{LO} = 830MHz to 870MHz (Note 3)	38	47		dB
RF Port Return Loss				18		dB
LO Port Return Loss		LO1/LO2 port selected, LO2/LO1, RF, and IF terminated into 50Ω		19		dB
		LO1/LO2 port unselected, LO2/LO1, RF, and IF terminated into 50Ω		31		
IF Port Return Loss		LO driven at 0dBm, RF terminated into 50Ω		23		dB

AC ELECTRICAL CHARACTERISTICS (DOWNCONVERTER OPERATION)

(Typical Application Circuit, C5 = 3.3pF, L1 and C4 not used, V_{CC} = +4.75V to +5.25V, RF and LO ports are driven from 50Ω sources, P_{LO} = -3dBm to +3dBm, P_{RF} = 0dBm, f_{RF} = 815MHz to 1000MHz, f_{LO} = 570MHz to 900MHz, f_{IF} = 90MHz, f_{LO} < f_{RF}, T_C = -40°C to +85°C, unless otherwise noted. Typical values are at V_{CC} = +5V, P_{LO} = 0dBm, f_{RF} = 920MHz, f_{LO} = 830MHz, f_{IF} = 90MHz, T_C = +25°C, unless otherwise noted.) (Note 1)

PARAMETER	SYMBOL	CONDITIONS	MIN	TYP	MAX	UNITS
Conversion Loss	G _C			6.5		dB
Conversion Loss Flatness (Note 3)		Flatness over any one of three frequency bands (f _{IF} = 90MHz): f _{RF} = 827MHz to 849MHz f _{RF} = 869MHz to 894MHz f _{RF} = 880MHz to 915MHz		±0.2		dB
		f _{RF} = 920MHz to 960MHz			±0.4	
Conversion Loss Variation Over Temperature		T _C = +25°C to -40°C		-0.28		dB
		T _C = +25°C to +85°C		0.35		
Input Compression Point	P _{1dB}	(Note 4)		27		dBm
Input Third-Order Intercept Point	IIP3	f _{RF1} = 920MHz, f _{RF2} = 921MHz, P _{RF} = 0dBm/tone, P _{LO} = 0dBm, T _C = +25°C (Note 3)	33	36.5		dBm
Input IP3 Variation Over Temperature	IIP3	T _C = +25°C to -40°C		-0.6		dB
		T _C = +25°C to +85°C		0.4		
Output Third-Order Intercept Point	OIP3	f _{RF1} = 920MHz, f _{RF2} = 921MHz, P _{RF} = 0dBm/tone, P _{LO} = 0dBm, T _C = +25°C (Note 3)	26	30		dBm
Spurious Response at IF (Note 3)	2 x 2	2RF - 2LO, P _{RF} = -10dBm, f _{RF} = 920MHz to 960MHz (f _{LO} = 830MHz to 870MHz), T _C = +25°C	62	72		dBc
	3 x 3	3RF - 3LO, P _{RF} = -10dBm		96		
Noise Figure	NF	Single sideband		6.7		dB
Noise Figure Under Blocking (Note 5)		P _{BLOCKER} = +8dBm		15		dB
		P _{BLOCKER} = +12dBm		19		

高线性度、815MHz至1000MHz 上变频/下变频混频器，带有LO缓冲器/开关

MAX2029

AC ELECTRICAL CHARACTERISTICS (UPCONVERTER OPERATION)

(Typical Application Circuit, L1 = 4.7nH, C4 = 4.7pF, C5 not used, V_{CC} = +4.75V to +5.25V, RF and LO ports are driven from 50Ω sources, P_{LO} = -3dBm to +3dBm, P_{IF} = 0dBm, f_{RF} = 815MHz to 1000MHz, f_{LO} = 570MHz to 900MHz, f_{IF} = 90MHz, f_{LO} < f_{RF}, T_C = -40°C to +85°C, unless otherwise noted. Typical values are at V_{CC} = +5V, P_{LO} = 0dBm, f_{RF} = 920MHz, f_{LO} = 830MHz, f_{IF} = 90MHz, T_C = +25°C, unless otherwise noted.) (Note 1)

PARAMETER	SYMBOL	CONDITIONS	MIN	TYP	MAX	UNITS
Conversion Loss	G _C			6		dB
Conversion Loss Flatness		Flatness over any one of four frequency bands (f _{IF} = 90MHz): f _{RF} = 827MHz to 849MHz f _{RF} = 869MHz to 894MHz f _{RF} = 880MHz to 915MHz f _{RF} = 920MHz to 960MHz		±0.3		dB
Conversion Loss Variation Over Temperature		T _C = +25°C to -40°C		-0.4		dB
		T _C = +25°C to +85°C		0.3		
Input Compression Point	P _{1dB}	(Note 4)		25		dBm
Input Third-Order Intercept Point	IIP3	f _{IF1} = 90MHz, f _{IF2} = 91MHz (results in f _{RF1} = 920MHz, f _{RF2} = 921MHz), P _{IF} = 0dBm/tone, P _{LO} = 0dBm, T _C = +25°C (Note 3)	34	39		dBm
Input IP3 Variation Over Temperature	IIP3	T _C = +25°C to -40°C		-0.6		dB
		T _C = +25°C to +85°C		-0.6		
LO ± 2IF Spur				71		dBc
LO ± 3IF Spur				86		dBc
Output Noise Floor		P _{OUT} = 0dBm (Note 5)		-167		dBm/Hz

Note 1: All limits include external component losses. Output measurements are taken at IF or RF port of the *Typical Application Circuit*.

Note 2: Operation outside this range is possible, but with degraded performance of some parameters.

Note 3: Guaranteed by design.

Note 4: Compression point characterized. It is advisable not to continuously operate the mixer RF/IF inputs above +15dBm.

Note 5: Measured with external LO source noise filtered, so its noise floor is -174dBm/Hz at 100MHz offset. This specification reflects the effects of all SNR degradations in the mixer, including the LO noise as defined in *Maxim Application Note 2021*.

高线性度、815MHz至1000MHz 上变频/下变频混频器，带有LO缓冲器/开关

典型工作特性

(Typical Application Circuit, C5 = 3.3pF, L1 and C4 not used, V_{CC} = +5.0V, P_{LO} = 0dBm, P_{RF} = 0dBm, f_{LO} < f_{RF}, f_{IF} = 90MHz, unless otherwise noted.)

MAX2029

Downconverter Curves

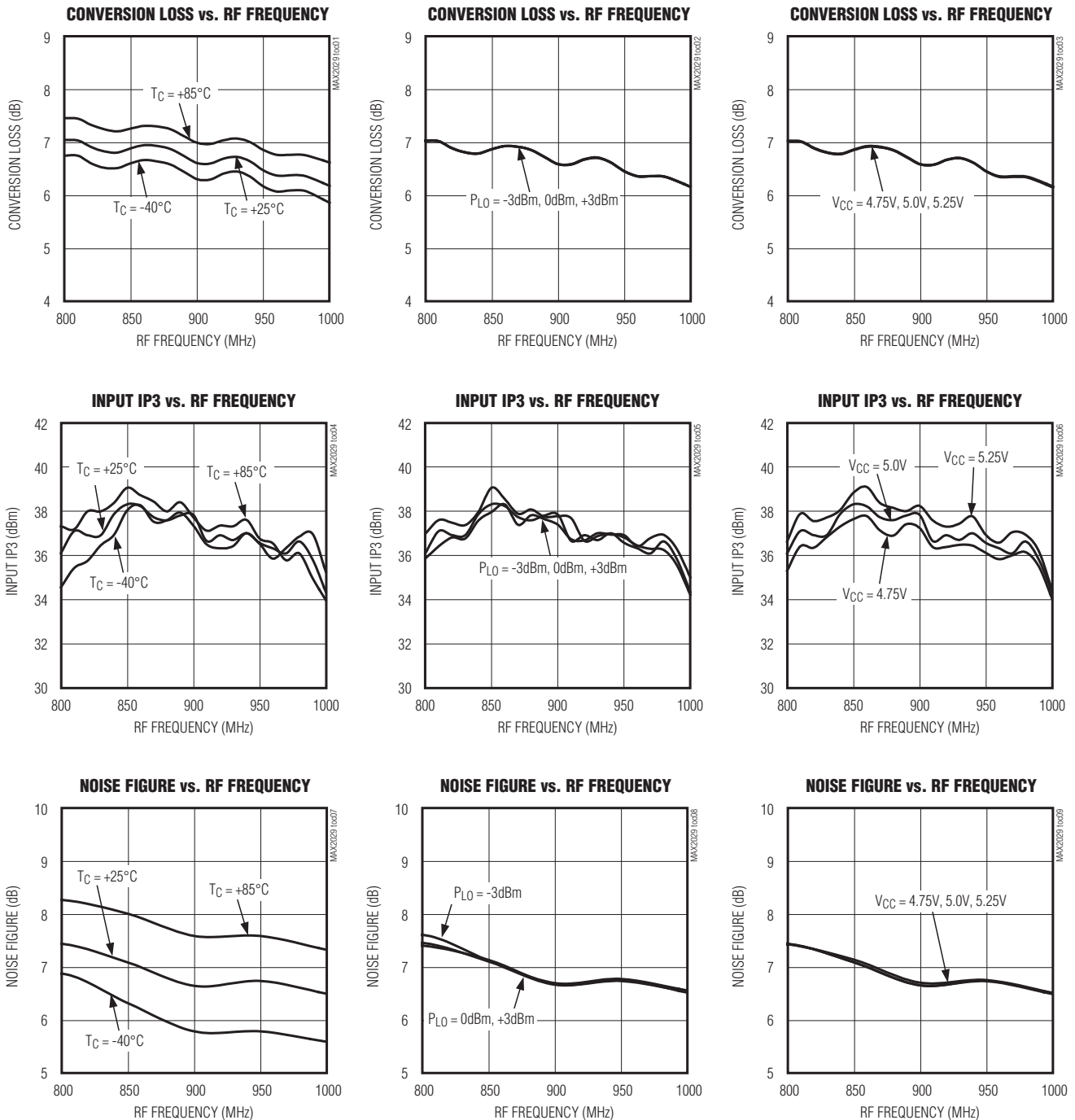

高线性度、815MHz至1000MHz 上变频/下变频混频器，带有LO缓冲器/开关

典型工作特性(续)

(Typical Application Circuit, C5 = 3.3pF, L1 and C4 not used, V_{CC} = +5.0V, P_{LO} = 0dBm, P_{RF} = 0dBm, f_{LO} < f_{RF}, f_{IF} = 90MHz, unless otherwise noted.)

Downconverter Curves

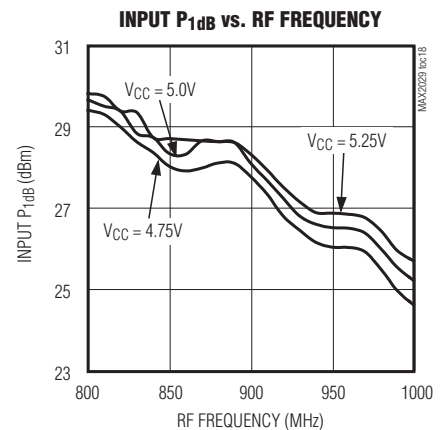
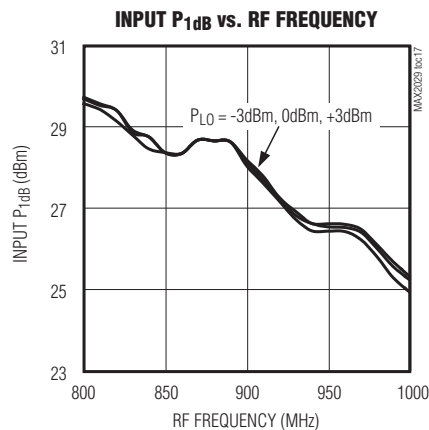
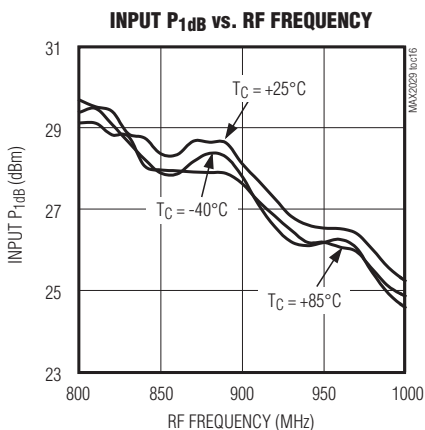
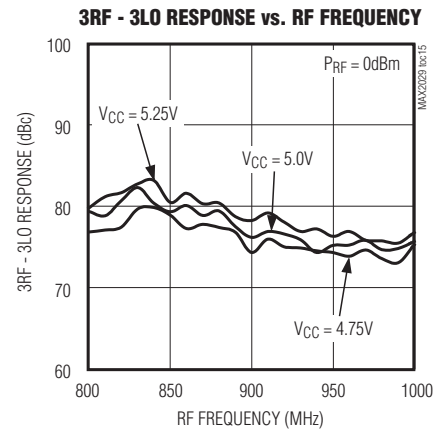
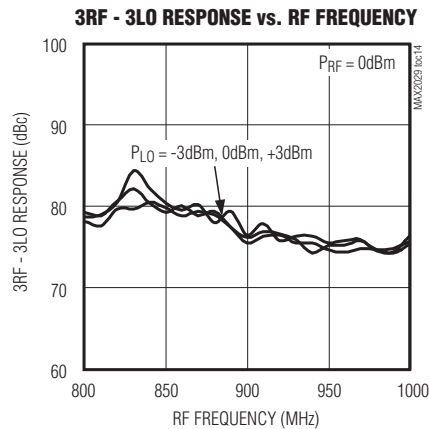
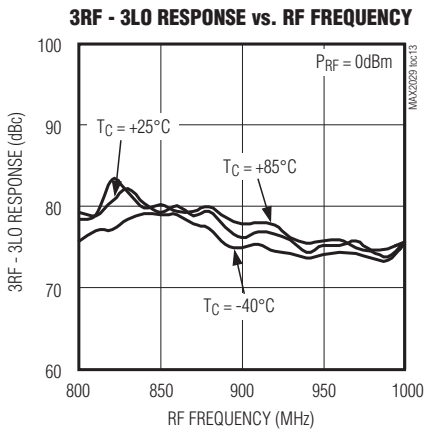
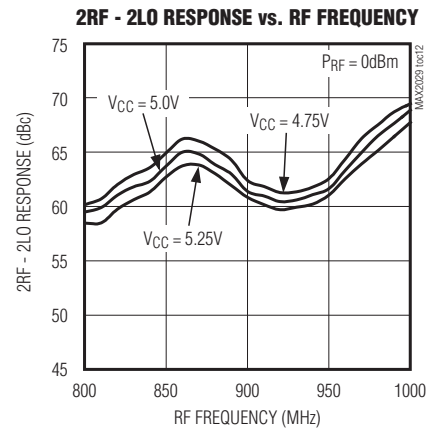
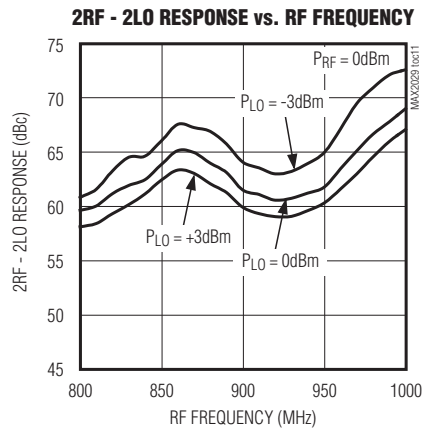
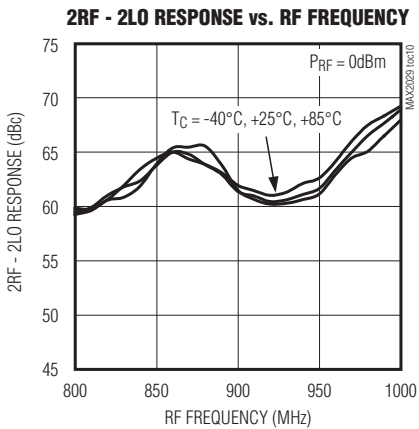

高线性度、815MHz至1000MHz 上变频/下变频混频器，带有LO缓冲器/开关

典型工作特性(续)

(Typical Application Circuit, C5 = 3.3pF, L1 and C4 not used, V_{CC} = +5.0V, P_{LO} = 0dBm, P_{RF} = 0dBm, f_{LO} < f_{RF}, f_{IF} = 90MHz, unless otherwise noted.)

Downconverter Curves

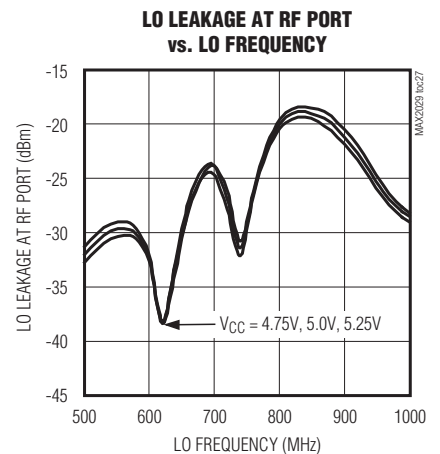
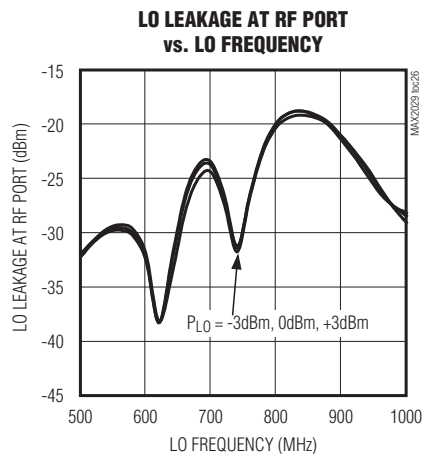
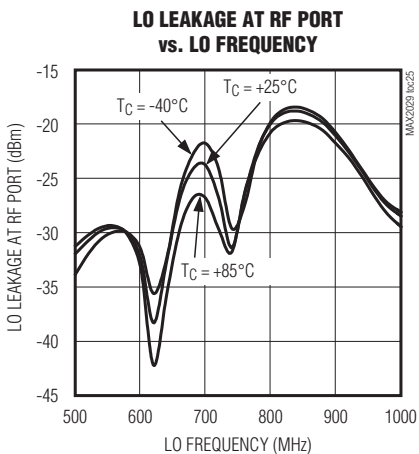
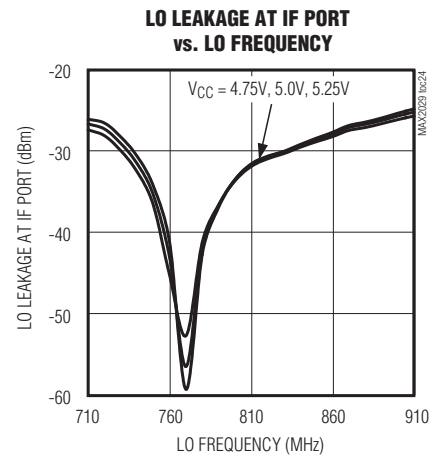
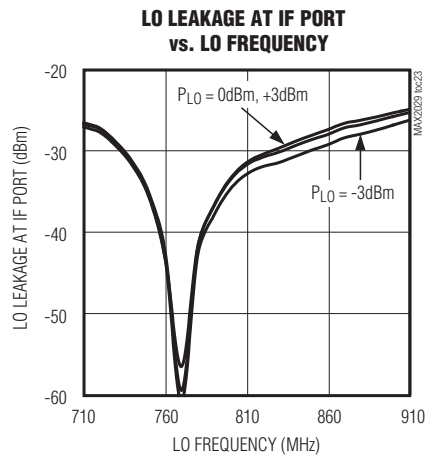
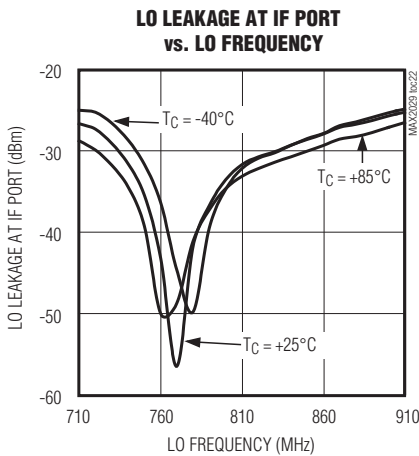
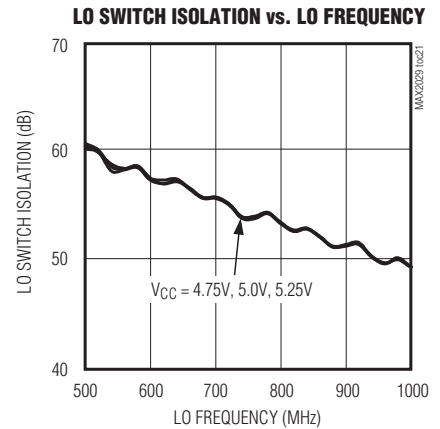
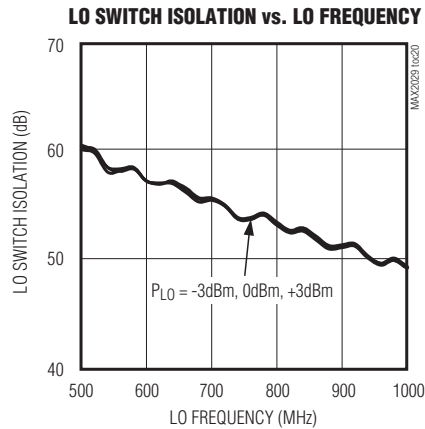
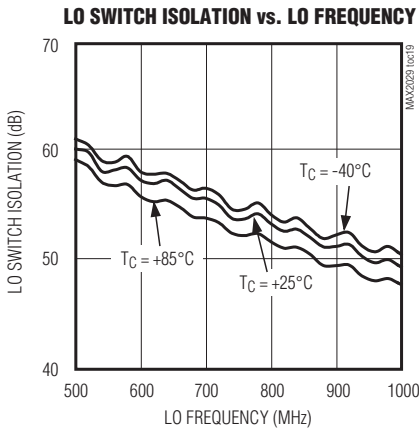

高线性度、815MHz至1000MHz 上变频/下变频混频器，带有LO缓冲器/开关

典型工作特性(续)

(Typical Application Circuit, C5 = 3.3pF, L1 and C4 not used, V_{CC} = +5.0V, P_{LO} = 0dBm, P_{RF} = 0dBm, f_{LO} < f_{RF}, f_{IF} = 90MHz, unless otherwise noted.)

Downconverter Curves

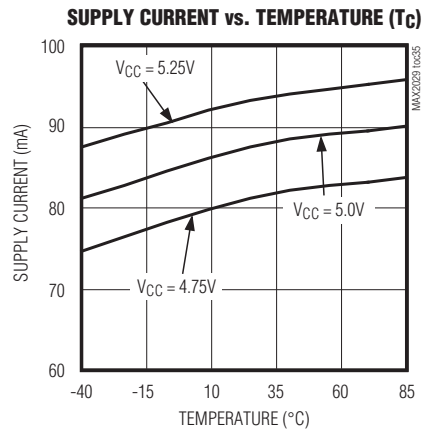
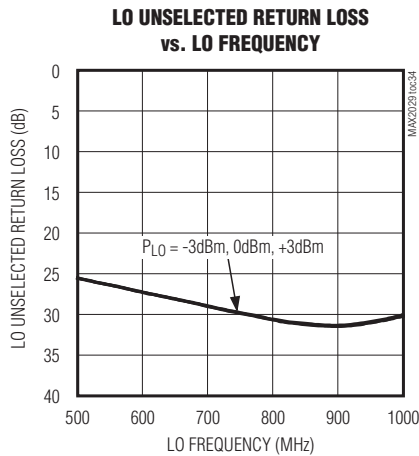
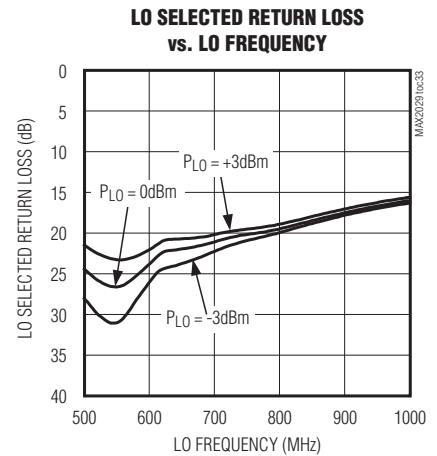
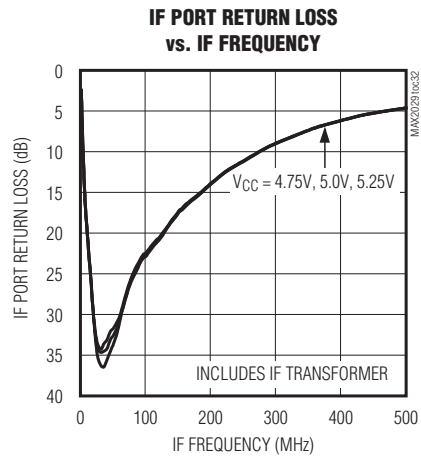
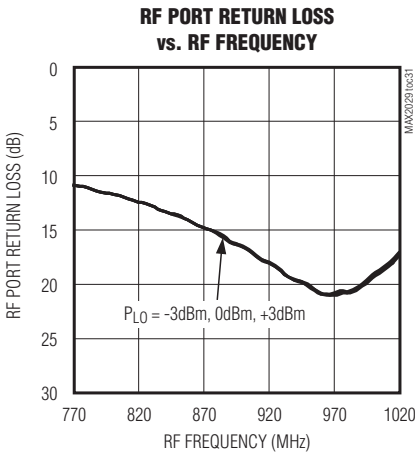
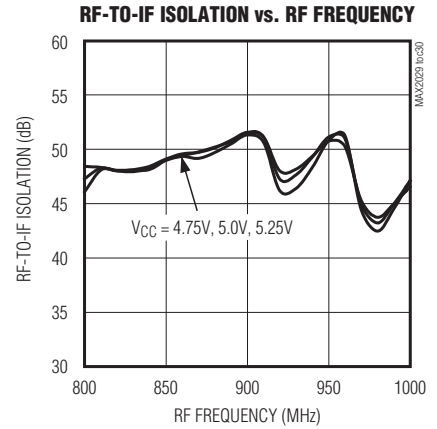
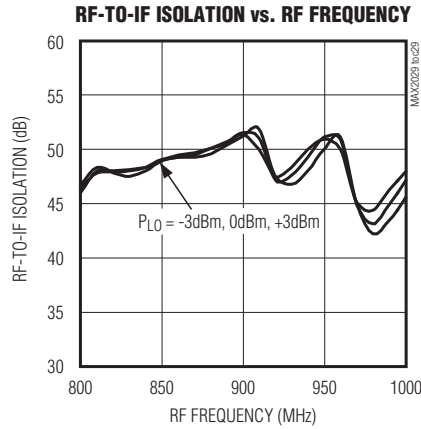
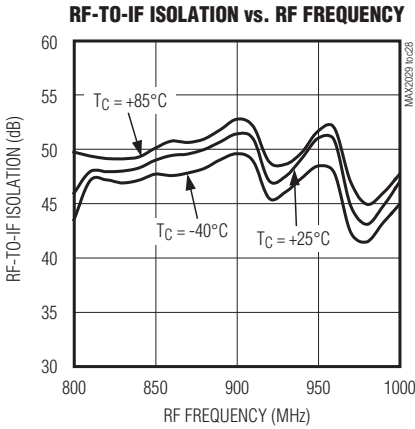

高线性度、815MHz至1000MHz 上变频/下变频混频器，带有LO缓冲器/开关

典型工作特性(续)

(Typical Application Circuit, L1 = 4.7nH, C4 = 4.7pF, C5 not used, VCC = +5.0V, PLO = 0dBm, PIF = 0dBm, fRF = fLO + fIF, fIF = 90MHz, unless otherwise noted.)

MAX2029

Upconverter Curves

CONVERSION LOSS vs. RF FREQUENCY
(L-C BPF TUNED FOR 940MHz RF FREQUENCY)

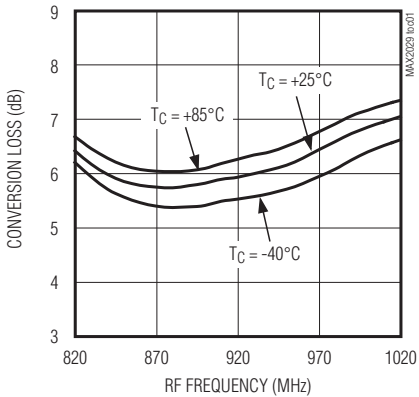

CONVERSION LOSS vs. RF FREQUENCY
(L-C BPF TUNED FOR 940MHz RF FREQUENCY)

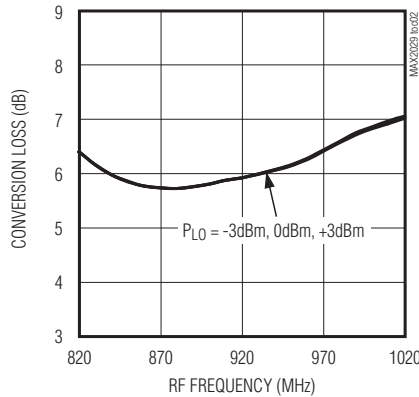

CONVERSION LOSS vs. RF FREQUENCY
(L-C BPF TUNED FOR 940MHz RF FREQUENCY)

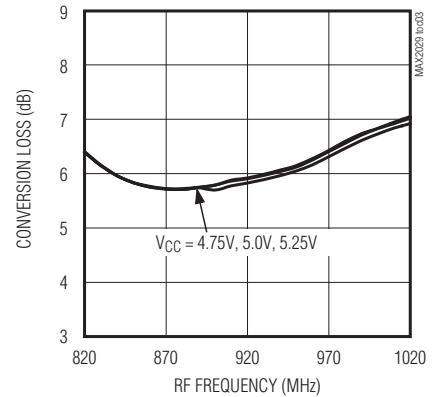

INPUT IP3 vs. RF FREQUENCY
(L-C BPF TUNED FOR 940MHz RF FREQUENCY)

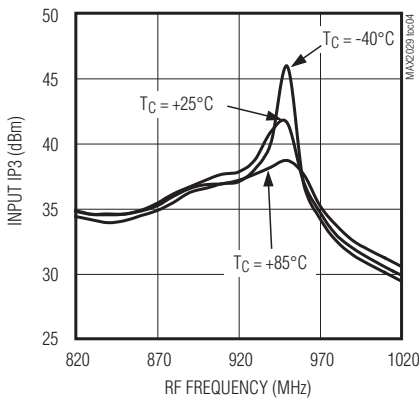

INPUT IP3 vs. RF FREQUENCY
(L-C BPF TUNED FOR 940MHz RF FREQUENCY)

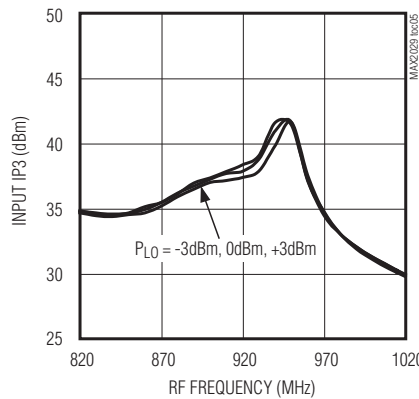

INPUT IP3 vs. RF FREQUENCY
(L-C BPF TUNED FOR 940MHz RF FREQUENCY)

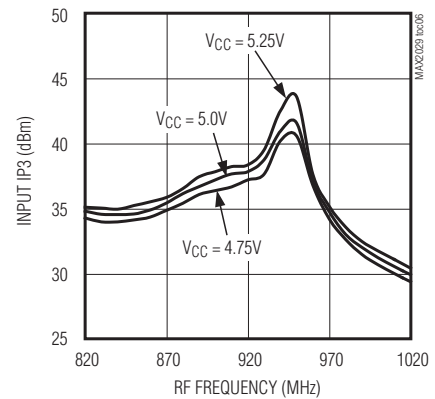

LO + 2IF REJECTION vs. LO FREQUENCY
(L-C BPF TUNED FOR 940MHz RF FREQUENCY)

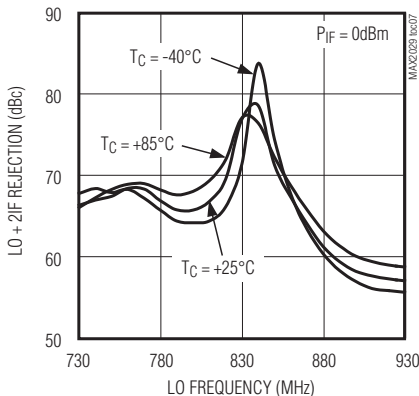

LO + 2IF REJECTION vs. LO FREQUENCY
(L-C BPF TUNED FOR 940MHz RF FREQUENCY)

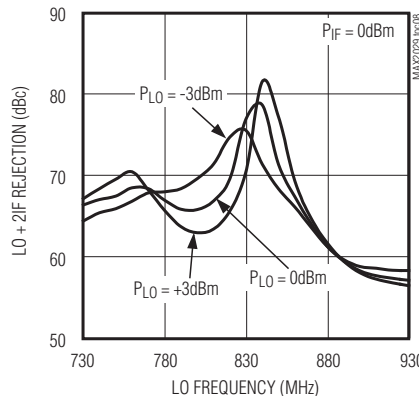

LO + 2IF REJECTION vs. LO FREQUENCY
(L-C BPF TUNED FOR 940MHz RF FREQUENCY)

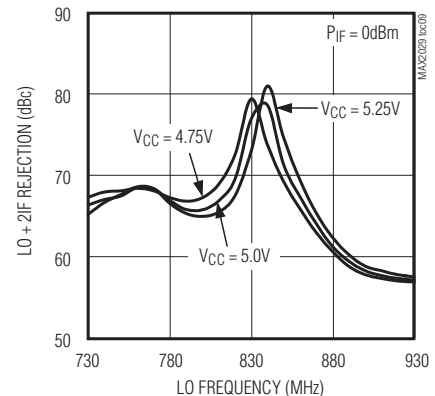

高线性度、815MHz至1000MHz 上变频/下变频混频器，带有LO缓冲器/开关

典型工作特性(续)

(Typical Application Circuit, L1 = 4.7nH, C4 = 4.7pF, C5 not used, VCC = +5.0V, PLO = 0dBm, PIF = 0dBm, fRF = fLO + fIF, fIF = 90MHz, unless otherwise noted.)

Upconverter Curves

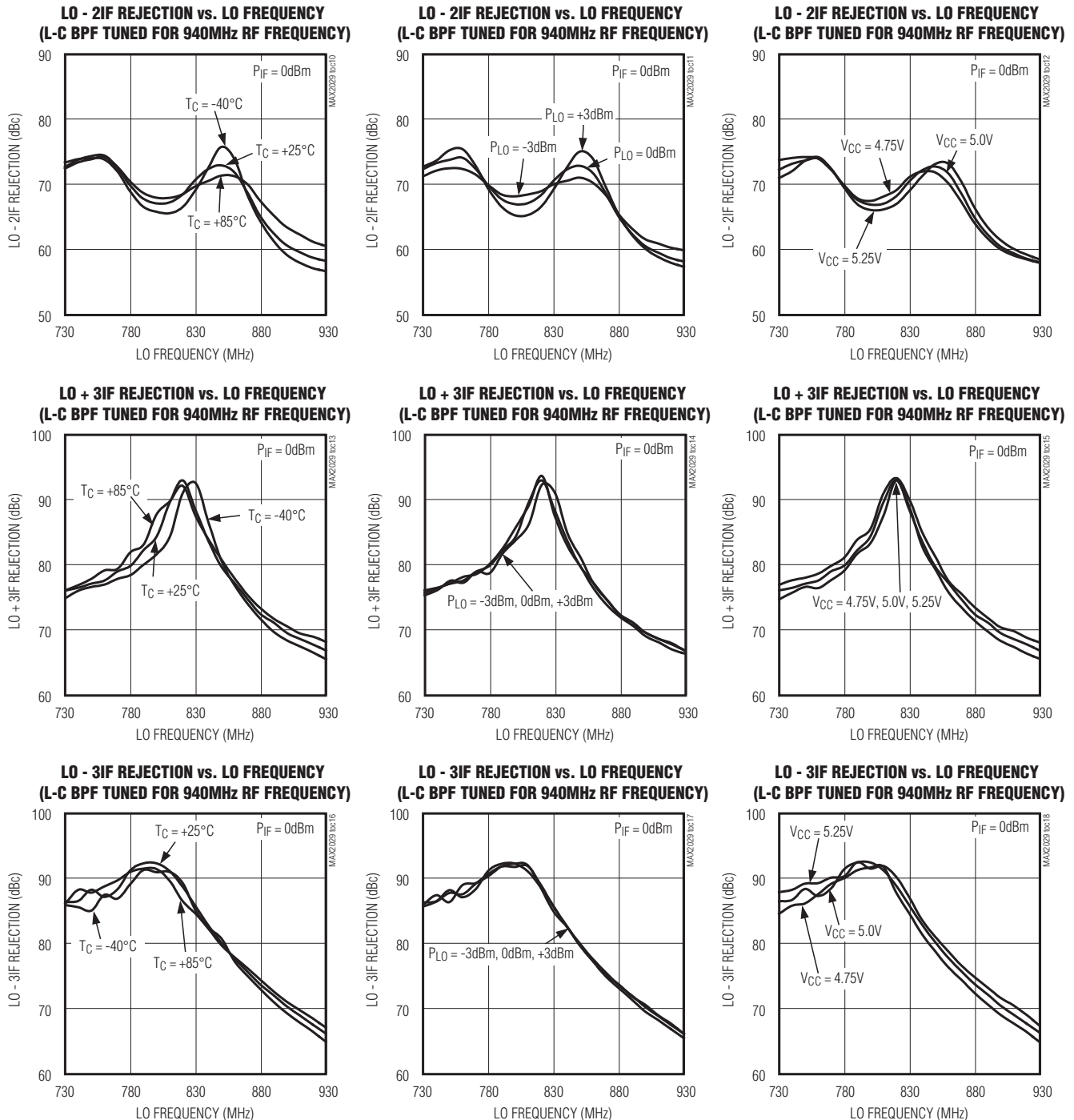

高线性度、815MHz至1000MHz 上变频/下变频混频器，带有LO缓冲器/开关

典型工作特性(续)

(Typical Application Circuit, L1 = 4.7nH, C4 = 4.7pF, C5 not used, VCC = +5.0V, PLO = 0dBm, PIF = 0dBm, fRF = fLO + fIF, fIF = 90MHz, unless otherwise noted.)

MAX2029

Upconverter Curves

LO LEAKAGE AT RF PORT vs. LO FREQUENCY
(L-C BPF TUNED FOR 940MHz RF FREQUENCY)

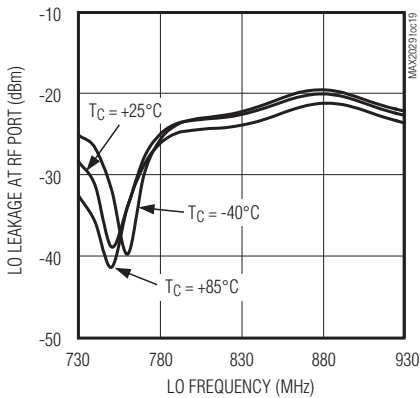

LO LEAKAGE AT RF PORT vs. LO FREQUENCY
(L-C BPF TUNED FOR 940MHz RF FREQUENCY)

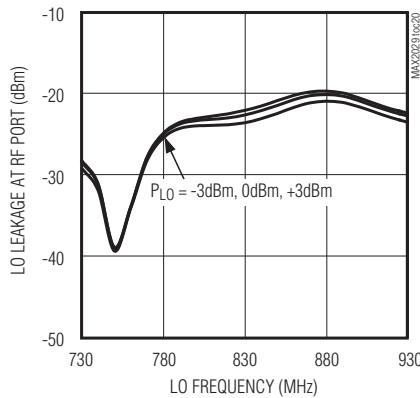

LO LEAKAGE AT RF PORT vs. LO FREQUENCY
(L-C BPF TUNED FOR 940MHz RF FREQUENCY)

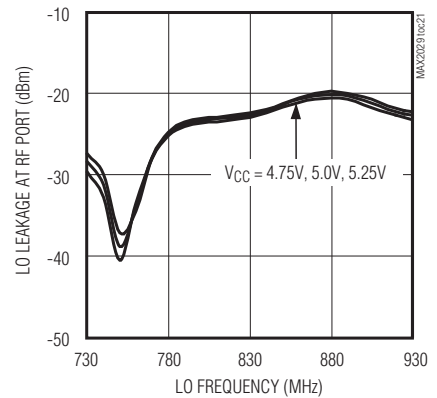

IF LEAKAGE AT RF vs. LO FREQUENCY
(L-C BPF TUNED FOR 940MHz RF FREQUENCY)

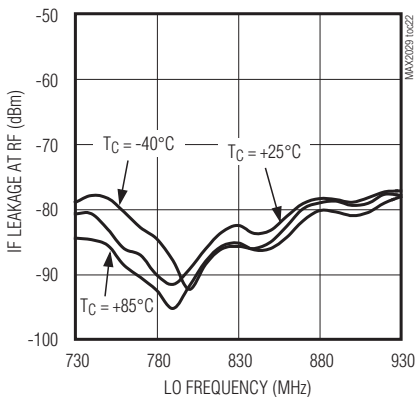

IF LEAKAGE AT RF vs. LO FREQUENCY
(L-C BPF TUNED FOR 940MHz RF FREQUENCY)

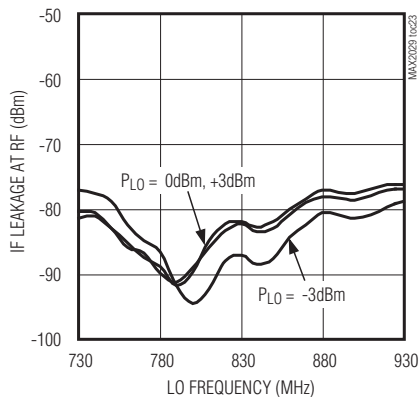

IF LEAKAGE AT RF vs. LO FREQUENCY
(L-C BPF TUNED FOR 940MHz RF FREQUENCY)

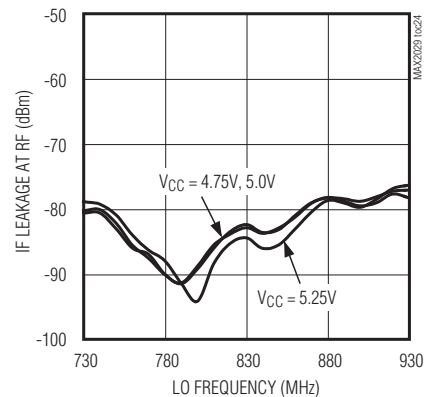

RF PORT RETURN LOSS vs. RF FREQUENCY
(L-C BPF TUNED FOR 940MHz RF FREQUENCY)

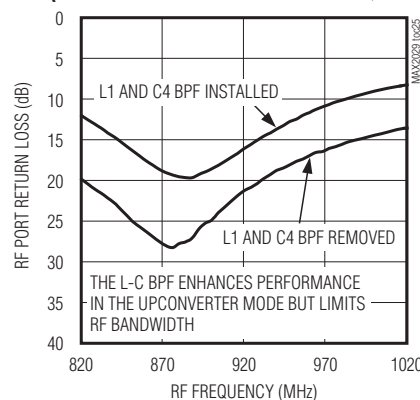

高线性度、815MHz至1000MHz 上变频/下变频混频器，带有LO缓冲器/开关

引脚	名称	功能
1, 6, 8, 14	V _{CC}	电源，将每个V _{CC} 引脚都通过电容旁路到GND，如典型应用电路所示。
2	RF	单端50Ω RF输入/输出。该端口由内部匹配，并通过非平衡变压器直流短路到GND。
3	TAP	内部RF非平衡变压器的中心抽头，连接至地。
4, 5, 10, 12, 13, 16, 17, 20	GND	地，连接至PCB的地平面，以保证正常工作，有助于改善引脚间的隔离。
7	LOBIAS	内部LO缓冲器的偏置电阻。在LOBIAS与电源之间接一个523Ω ±1%的电阻。
9	LOSEL	本地振荡器选择，通过逻辑控制输入选择LO1或LO2。
11	LO1	本地振荡器输入1，将LOSEL驱动至低电平选择LO1。
15	LO2	本地振荡器输入2，将LOSEL驱动至高电平选择LO2。
18, 19	IF-, IF+	差分IF输入/输出。
EP	GND	接地裸焊盘，该裸焊盘通过多个过孔焊接到地平面。

详细说明

MAX2029可作为下变频混频器或上变频混频器使用。用作下变频混频器时，MAX2029具有6.5dB的变频损耗、6.7dB的噪声系数以及+36.5dBm的三阶输入截点(IIP3)。集成非平衡变压器和匹配电路实现了RF端口和两个LO端口的50Ω单端连接。RF端口可作为下变频器的输入或上变频器的输出。单刀双掷(SPDT)开关在两个LO输入之间切换时具有50ns的开关时间，LO之间的隔离度为53dB。此外，集成LO缓冲器可为混频器核提供高驱动电平，将MAX2029输入所需的LO驱动减小到-3dBm至+3dBm。下变频时，IF端口具有差分输出，可以改善IIP2性能；上变频时，IF端口作为差分输入。

保证在较宽的频率范围内符合规范要求，可广泛地用于WCDMA、cdmaOne™、cdma2000和GSM 850/GSM 900 2.5G EDGE基站。MAX2029工作在815MHz至1000MHz的RF频率范围、570MHz至900MHz的LO频率范围，以及直流至250MHz的IF频率范围。器件也可工作在上述频率范围之外，详情请参阅典型工作特性。

MAX2029理想工作于低端LO注入结构，器件也可以工作在高端LO注入，具有扩展的LO范围，但其性能会随着 f_{LO} 的增加而降低。典型工作特性中给出了 f_{LO} 高达1000MHz的测试结果。如需适用于高端LO注入的引脚兼容器件，请参考MAX2031数据资料。

RF端口和非平衡变压器

当MAX2029作为下变频器使用时，RF输入端内部匹配至50Ω，无需外部匹配元件。由于输入端口通过内部非平衡变压器直流短路到地，所以需要隔直流电容。在整个815MHz至1000MHz RF频率范围内，RF回波损耗的典型值优于15dB。作为上变频器使用时，RF单端输出同样匹配至50Ω。

LO输入、缓冲器和非平衡变压器

在570MHz至900MHz LO频率范围内，MAX2029可理想用于低端LO注入结构。对于LO频率范围为960MHz至1180MHz的器件，请参考MAX2031数据资料。MAX2029还包括内部LO SPDT开关，这一附加功能使其能够用于跳频设计。该开关用来选择两个单端LO端口，允许外部振荡器在开关接通之前建立在特定频率上。LO开关时间典型值小于50ns，能够满足绝大多数GSM应用的要求。如果不使用跳频功能，将开关设置到任意一个LO输入。该开关由数字输入(LOSEL)控制：数字输入为逻辑高电平时，选中LO2；为逻辑低电平时，选中LO1。为避免这部分电路损坏，在给LOSEL施加数字逻辑电平之前，必须先给V_{CC}通电(参见Absolute Maximum Ratings)。LO1和LO2输入内部匹配至50Ω，每个输入端需接一只82pF的隔直电容。

高线性度、815MHz至1000MHz 上变频/下变频混频器，带有LO缓冲器/开关

两级内部LO缓冲器为LO驱动提供很宽的输入功率范围。所有指标均规定于-3dBm至+3dBm LO信号功率条件下。片上低损耗非平衡变压器和LO缓冲器共同驱动双平衡混频器。LO输入至IF输出之间的接口和匹配元件均已集成在芯片内部。

高线性度混频器

MAX2029的核心是一个双平衡、高性能的无源混频器。内部LO缓冲器输出具有较高的LO摆幅，提供出色的线性度。

差分IF

MAX2029混频器的IF频率范围是直流至250MHz。这些差分端口对于提供增强的IIP2性能非常有效。单端IF应用需要一个1:1非平衡变压器将IF 50Ω差分阻抗转化为50Ω单端阻抗。经过非平衡变压器转换之后，IF回波损耗优于15dB。用作上变频器时，差分IF作为输入端口。用户可在混频器之后接一个差分IF放大器，但此时两个IF引脚需要隔直流。

应用信息

输入和输出匹配

RF和LO输入端内部匹配至50Ω，无需外接匹配元件。用作下变频器时，在整个输入范围(815MHz至1000MHz)内，RF端口的典型回波损耗优于15dB；LO端口的典型回波损耗为15dB (570MHz至850MHz)。RF和LO输入端只需要连接隔直流电容。

可以选择在RF端口安装L-C带通滤波器(BPF)，以提高上变频转换的性能。典型应用电路和典型工作特性提供了配合调谐在920MHz RF频率的L-C BPF工作时，上变频器的工作状况。选择不同的L1和C4，可以针对其它频率优化工作性能。移除L1和C4可以获得更宽的匹配范围，但会降低性能指标，详细信息请联系工厂。

IF输出阻抗为50Ω (差分)。为方便评估，通过外部低损耗1:1 (阻抗比)非平衡变压器将该阻抗转化为50Ω单端输出(参见典型应用电路)。

偏置电阻

LO缓冲器的偏置电流可以通过微调电阻R1进行优化。如果需要以降低性能为代价来降低电流，请与工厂联系。如果很难找到±1%的偏置电阻，可以用±5%的标准电阻代替。

布局考虑

设计合理的PCB是RF/微波电路的基本要求，需保证RF信号线尽可能短，以减小损耗、辐射和电感。为获得最佳性能，将接地引脚直接连接到封装底部的裸焊盘，PCB的裸焊盘必须连接至PCB的地层。连接裸焊盘至地层时，推荐使用多个过孔。这种方法为器件提供了良好的RF/导热路径，将器件封装背面的裸焊盘焊接至PCB。电路板布局可以参考MAX2029评估板，Gerber文件可在www.maxim-ic.com.cn申请得到。

电源旁路

合理的电源旁路对高频电路的稳定性至关重要。用电容旁路每一个V_{CC}引脚，如典型应用电路所示，并参考表1。

表1. 典型应用电路元件列表

COMPONENT	VALUE	DESCRIPTION
C1, C2, C7, C8, C10, C11, C12	82pF	Microwave capacitors (0603)
C3, C6, C9	10nF	Microwave capacitors (0603)
C4*	4.7pF	Microwave capacitor (0603)
C5**	3.3pF	Microwave capacitor (0603)
L1*	4.7nH	Inductor (0603)
R1	523Ω	±1% resistor (0603)
T1	1:1	IF balun M/A-COM: MABAES0029
U1	MAX2029	Maxim IC

*仅在混频器用作上变频器时安装C4和L1。

**仅在混频器用作下变频器时安装C5。

裸焊盘RF/散热考虑

MAX2029 20引脚薄型QFN-EP封装的裸焊盘(EP)提供了一条连接至管芯的低热阻通路。设计PCB时，使其通过MAX2029的EP导热非常重要。此外，EP与电气地之间还提供了一条低电感通路。EP必须直接或通过一系列电镀过孔焊接至PCB的地层。

高线性度、815MHz至1000MHz 上变频/下变频混频器，带有LO缓冲器/开关

典型应用电路

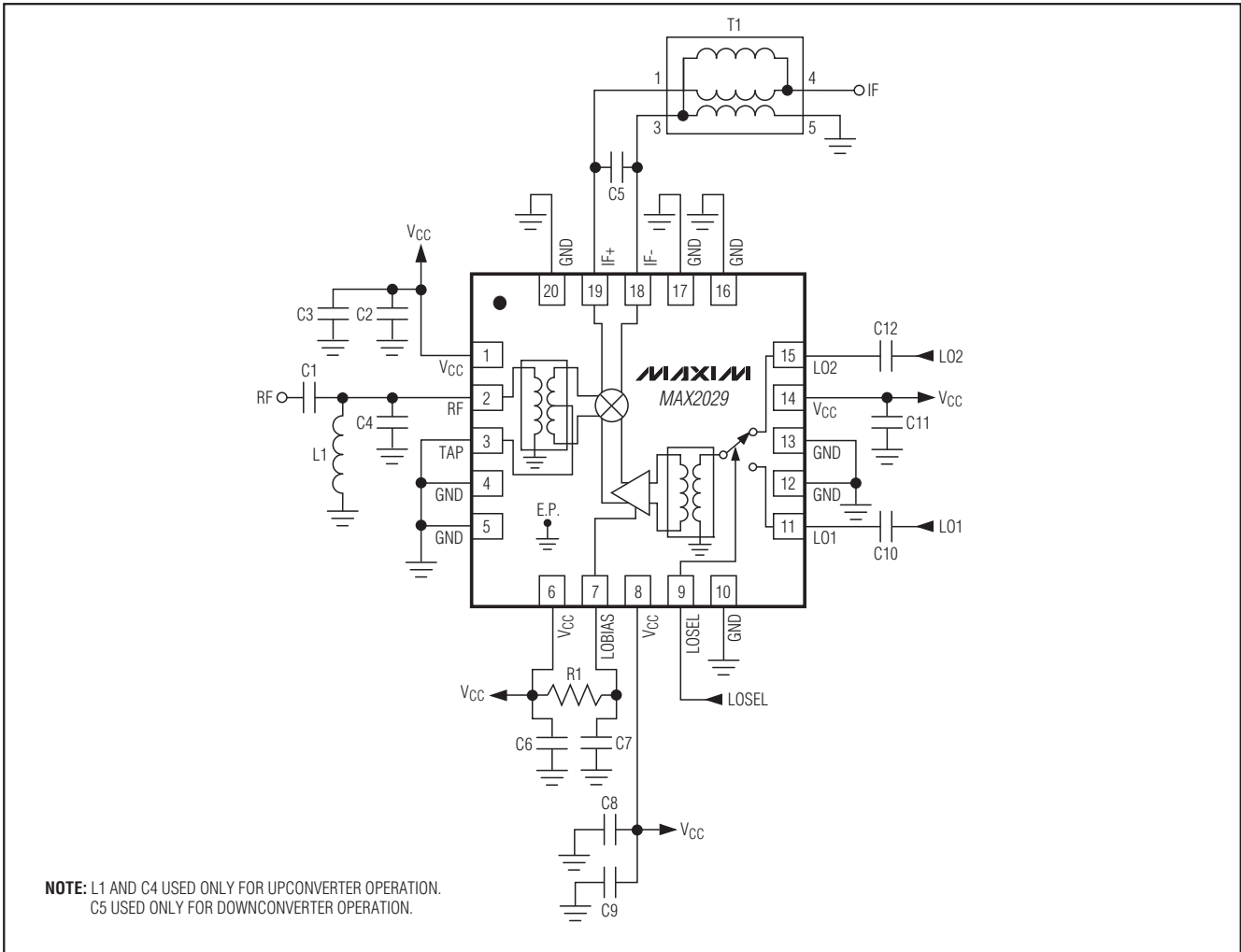

芯片信息

PROCESS: SiGe BiCMOS

高线性度、815MHz至1000MHz 上变频/下变频混频器，带有LO缓冲器/开关

封装信息

(本数据资料提供的封装图可能不是最近的规格，如需最近的封装外形信息，请查询 www.maxim-ic.com.cn/packages.)

MAX2029

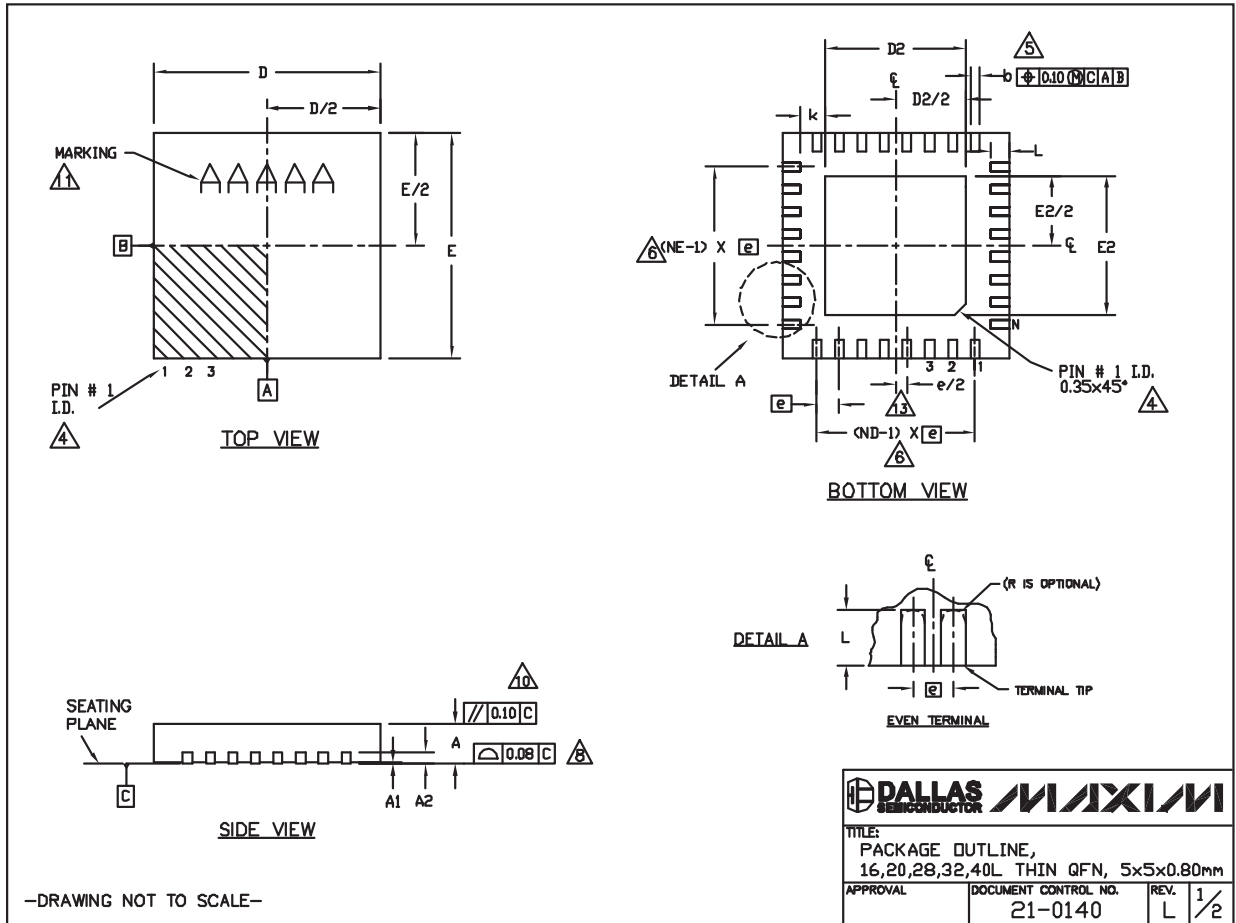

高线性度、815MHz至1000MHz 上变频/下变频混频器，带有LO缓冲器/开关

封装信息(续)

(本数据资料提供的封装图可能不是最近的规格，如需最近的封装外形信息，请查询 www.maxim-ic.com.cn/packages.)

COMMON DIMENSIONS															
PKG	16L 5x5			20L 5x5			28L 5x5			32L 5x5			40L 5x5		
SYMBOL	MIN.	NOM.	MAX.	MIN.	NOM.	MAX.	MIN.	NOM.	MAX.	MIN.	NOM.	MAX.	MIN.	NOM.	MAX.
A	0.70	0.75	0.80	0.70	0.75	0.80	0.70	0.75	0.80	0.70	0.75	0.80	0.70	0.75	0.80
A1	0	0.02	0.05	0	0.02	0.05	0	0.02	0.05	0	0.02	0.05	0	0.02	0.05
A2	0.20 REF.			0.20 REF.			0.20 REF.			0.20 REF.			0.20 REF.		
b	0.25	0.30	0.35	0.25	0.30	0.35	0.20	0.25	0.30	0.20	0.25	0.30	0.15	0.20	0.25
D	4.90	5.00	5.10	4.90	5.00	5.10	4.90	5.00	5.10	4.90	5.00	5.10	4.90	5.00	5.10
E	4.90	5.00	5.10	4.90	5.00	5.10	4.90	5.00	5.10	4.90	5.00	5.10	4.90	5.00	5.10
e	0.80 BSC.			0.65 BSC.			0.50 BSC.			0.50 BSC.			0.40 BSC.		
k	0.25	-	-	0.25	-	-	0.25	-	-	0.25	-	-	0.25	-	-
L	0.30	0.40	0.50	0.45	0.55	0.65	0.45	0.55	0.65	0.30	0.40	0.50	0.30	0.40	0.50
N	16			20			28			32			40		
ND	4			5			7			8			10		
NE	4			5			7			8			10		
JEDEC	VHFB			VHHC			WHHD-1			WHHD-2			----		

EXPOSED PAD VARIATIONS						
PKG CODES	D2			E2		
	MIN.	NOM.	MAX.	MIN.	NOM.	MAX.
T1655-2	3.00	3.10	3.20	3.00	3.10	3.20
T1655-3	3.00	3.10	3.20	3.00	3.10	3.20
T1655N-1	3.00	3.10	3.20	3.00	3.10	3.20
T2055-3	3.00	3.10	3.20	3.00	3.10	3.20
T2055-4	3.00	3.10	3.20	3.00	3.10	3.20
T2055-5	3.15	3.25	3.35	3.15	3.25	3.35
T2055MN-5	3.15	3.25	3.35	3.15	3.25	3.35
T2855-3	3.15	3.25	3.35	3.15	3.25	3.35
T2855-4	2.60	2.70	2.80	2.60	2.70	2.80
T2855-5	2.60	2.70	2.80	2.60	2.70	2.80
T2855-6	3.15	3.25	3.35	3.15	3.25	3.35
T2855-7	2.60	2.70	2.80	2.60	2.70	2.80
T2855-8	3.15	3.25	3.35	3.15	3.25	3.35
T2855N-1	3.15	3.25	3.35	3.15	3.25	3.35
T3255-3	3.00	3.10	3.20	3.00	3.10	3.20
T3255-4	3.00	3.10	3.20	3.00	3.10	3.20
T3255M-4	3.00	3.10	3.20	3.00	3.10	3.20
T3255-5	3.00	3.10	3.20	3.00	3.10	3.20
T3255N-1	3.00	3.10	3.20	3.00	3.10	3.20
T4055-1	3.40	3.50	3.60	3.40	3.50	3.60
T4055-2	3.40	3.50	3.60	3.40	3.50	3.60
T4055MN-1	3.40	3.50	3.60	3.40	3.50	3.60

NOTES:

- DIMENSIONING & TOLERANCING CONFORM TO ASME Y14.5M-1994.
- ALL DIMENSIONS ARE IN MILLIMETERS. ANGLES ARE IN DEGREES.
- N IS THE TOTAL NUMBER OF TERMINALS.
- THE TERMINAL #1 IDENTIFIER AND TERMINAL NUMBERING CONVENTION SHALL CONFORM TO JEDEC 95-1 SPP-012. DETAILS OF TERMINAL #1 IDENTIFIER ARE OPTIONAL, BUT MUST BE LOCATED WITHIN THE ZONE INDICATED. THE TERMINAL #1 IDENTIFIER MAY BE EITHER A MOLD OR MARKED FEATURE.
- DIMENSION b APPLIES TO METALIZED TERMINAL AND IS MEASURED BETWEEN 0.25 mm AND 0.30 mm FROM TERMINAL TIP.
- ND AND NE REFER TO THE NUMBER OF TERMINALS ON EACH D AND E SIDE RESPECTIVELY.
- DEPOPULATION IS POSSIBLE IN A SYMMETRICAL FASHION.
- COPLANARITY APPLIES TO THE EXPOSED HEAT SINK SLUG AS WELL AS THE TERMINALS.
- DRAWING CONFORMS TO JEDEC MO220, EXCEPT EXPOSED PAD DIMENSION FOR T2855-3, T2855-6, T4055-1 AND T4055-2.
- VARPAGE SHALL NOT EXCEED 0.10 mm.
- MARKING IS FOR PACKAGE ORIENTATION REFERENCE ONLY.
- NUMBER OF LEADS SHOWN ARE FOR REFERENCE ONLY.
- LEAD CENTERLINES TO BE AT TRUE POSITION AS DEFINED BY BASIC DIMENSION 'e', ±0.05.
- ALL DIMENSIONS APPLY TO BOTH LEADED AND PBFREE PARTS.

—DRAWING NOT TO SCALE—

			
TITLE: PACKAGE OUTLINE, 16,20,28,32,40L THIN QFN, 5x5x0.80mm			
APPROVAL	DOCUMENT CONTROL NO.	REV.	2/2
	21-0140	L	

Maxim北京办事处

北京 8328信箱 邮政编码 100083

免费电话: 800 810 0310

电话: 010-6211 5199

传真: 010-6211 5299

Maxim不对Maxim产品以外的任何电路使用负责，也不提供其专利许可。Maxim保留在任何时间、没有任何通报的前提下修改产品资料和规格的权利。

16 Maxim Integrated Products, 120 San Gabriel Drive, Sunnyvale, CA 94086 408-737-7600

© 2007 Maxim Integrated Products

MAXIM 是 Maxim Integrated Products, Inc. 的注册商标。