



双通道、SiGe、高线性度、1700MHz至2200MHz 下变频混频器，带有LO缓冲器/开关

MAX19995A

概述

MAX19995A 双通道、下变频混频器可为1700MHz至2200MHz接收机应用提供8.7dB增益、+24.8dBm输入IP3、+13.5dBm的1dB输入压缩点和9.2dB的噪声系数。该混频器具有1750MHz至2700MHz的优化LO频率范围，非常适合高端LO注入结构。MAX19995支持低端LO注入，与MAX19995A引脚、功能兼容。

除具有优异的线性度和噪声性能外，MAX19995A还具有非常高的元件集成度。该器件包括两个双平衡无源混频器核、两个LO缓冲器、一个双输入LO选择开关以及一对差分IF输出放大器。片内集成的非平衡变压器使器件能够接收单端RF和LO输入。MAX19995A需要一个标称为0dBm的LO驱动， $V_{CC} = 5.0V$ 时，电源电流典型值为350mA； $V_{CC} = 3.3V$ 时，电源电流典型值为242mA。

MAX19995/MAX19995A与MAX19985/MAX19985A系列700MHz至1000MHz混频器引脚兼容，与MAX19997A/MAX19999系列1800MHz至4000MHz混频器引脚相似。这使得该系列下变频混频器非常适合多个频段采用相同PCB布局的应用。

MAX19995A采用带裸焊盘的6mm x 6mm、36引脚、薄型QFN封装。在 $T_C = -40^{\circ}C$ 至 $+85^{\circ}C$ 扩展级温度范围内，可保证电气性能。

应用

UMTS/WCDMA 基站
LTE/WiMAX™ 基站
TD-SCDMA 基站
DCS1800/PCS1900和GSM/EDGE 基站
cdma2000® 基站
固定宽带无线接入
无线本地环路
个人移动无线装置
军用系统

特性

- ◆ 1700MHz至2200MHz RF频率范围
- ◆ 1750MHz至2700MHz LO频率范围
- ◆ 50MHz至500MHz IF频率范围
- ◆ 8.7dB典型转换增益
- ◆ 9.2dB典型噪声系数
- ◆ +24.8dBm典型输入IP3
- ◆ +13.5dBm典型输入1dB压缩点
- ◆ $P_{RF} = -10dBm$ 时，具有64dBc典型2LO-2RF杂散抑制
- ◆ 双通道理想用于分集接收机应用
- ◆ 48dB典型通道间隔离
- ◆ -3dBm至+3dBm的低LO驱动
- ◆ 集成LO缓冲器
- ◆ 内部RF和LO非平衡变压器支持单端输入
- ◆ 内置SPDT LO开关，LO至LO隔离度为48dB，开关时间为50ns
- ◆ 引脚兼容于MAX19985/MAX19985A/MAX19995系列700MHz至2200MHz混频器
- ◆ 引脚类似于MAX19997A/MAX19999系列1800MHz至4000MHz混频器
- ◆ 采用5.0V或3.3V单电源供电
- ◆ 外部电流设置电阻允许折中选择混频器的低功耗/低性能工作模式

订购信息

PART	TEMP RANGE	PIN-PACKAGE
MAX19995AETX+	-40°C to +85°C	36 Thin QFN-EP*
MAX19995AETX+T	-40°C to +85°C	36 Thin QFN-EP*

+表示无铅(Pb)/符合RoHS标准的封装。

*EP = 裸焊盘。

T = 卷带包装。

WiMAX是WiMAX论坛的商标。
cdma2000是电信工业协会的注册商标。

引脚配置/功能框图在数据资料的最后给出。



Maxim Integrated Products 1

本文是Maxim正式英文资料的译文，Maxim不对翻译中存在的差异或由此产生的错误负责。请注意译文中可能存在文字组织或翻译错误，如需确认任何词语的准确性，请参考Maxim提供的英文版资料。

索取免费样品和最新版的数据资料，请访问Maxim的主页：www.maxim-ic.com.cn。

双通道、SiGe、高线性度、1700MHz至2200MHz 下变频混频器，带有LO缓冲器/开关

ABSOLUTE MAXIMUM RATINGS

V _{CC} to GND	-0.3V to +5.5V	θ _{JA} (Notes 2, 3).....	+38°C/W
LO1, LO2 to GND	-0.3V to +0.3V	θ _{JC} (Notes 1, 3).....	7.4°C/W
LOSEL to GND	-0.3V to (V _{CC} + 0.3V)	Operating Case Temperature Range (Note 4)	-40°C to +85°C
RFMAIN, RFDIV, and LO_ Input Power	+15dBm	Junction Temperature	+150°C
RFMAIN, RFDIV Current (RF is DC shorted to GND through a balun).....	50mA	Storage Temperature Range	-65°C to +150°C
Continuous Power Dissipation (Note 1)	8.7W	Lead Temperature (soldering, 10s)	+300°C

Note 1: Based on junction temperature $T_J = T_C + (\theta_{JC} \times V_{CC} \times I_{CC})$. This formula can be used when the temperature of the exposed pad is known while the device is soldered down to a PCB. See the *Applications Information* section for details. The junction temperature must not exceed +150°C.

Note 2: Junction temperature $T_J = T_A + (\theta_{JA} \times V_{CC} \times I_{CC})$. This formula can be used when the ambient temperature of the PCB is known. The junction temperature must not exceed +150°C.

Note 3: Package thermal resistances were obtained using the method described in JEDEC specification JESD51-7, using a four-layer board. For detailed information on package thermal considerations, refer to www.maxim-ic.com.cn/thermal-tutorial.

Note 4: T_C is the temperature on the exposed pad of the package. T_A is the ambient temperature of the device and PCB.

Stresses beyond those listed under "Absolute Maximum Ratings" may cause permanent damage to the device. These are stress ratings only, and functional operation of the device at these or any other conditions beyond those indicated in the operational sections of the specifications is not implied. Exposure to absolute maximum rating conditions for extended periods may affect device reliability.

5.0V SUPPLY DC ELECTRICAL CHARACTERISTICS

(Typical Application Circuit, V_{CC} = 4.75V to 5.25V, no input AC signals. T_C = -40°C to +85°C, R1 = R4 = 681Ω, R2 = R5 = 1.5kΩ. Typical values are at V_{CC} = 5.0V, T_C = +25°C, unless otherwise noted. All parameters are production tested.)

PARAMETER	SYMBOL	CONDITIONS	MIN	TYP	MAX	UNITS
Supply Voltage	V _{CC}		4.75	5	5.25	V
Supply Current	I _{CC}	Total supply current, V _{CC} = 5.0V		350	410	mA
LOSEL Input High Voltage	V _{IH}		2			V
LOSEL Input Low Voltage	V _{IL}				0.8	V
LOSEL Input Current	I _{IH} and I _{IL}		-10		+10	μA

3.3V SUPPLY DC ELECTRICAL CHARACTERISTICS

(Typical Application Circuit, V_{CC} = 3.0V to 3.6V, no input AC signals. T_C = -40°C to +85°C, R1 = R4 = 909Ω, R2 = R5 = 1kΩ. Typical values are at V_{CC} = 3.3V, T_C = +25°C, unless otherwise noted. Parameters are guaranteed by design and not production tested.)

PARAMETER	SYMBOL	CONDITIONS	MIN	TYP	MAX	UNITS
Supply Voltage	V _{CC}		3.0	3.3	3.6	V
Supply Current	I _{CC}	Total supply current		242	300	mA
LOSEL Input High Voltage	V _{IH}			2		V
LOSEL Input Low Voltage	V _{IL}			0.8		V

双通道、SiGe、高线性度、1700MHz至2200MHz 下变频混频器，带有LO缓冲器/开关

MAX19995A

RECOMMENDED AC OPERATING CONDITIONS

PARAMETER	SYMBOL	CONDITIONS	MIN	TYP	MAX	UNITS
RF Frequency	f_{RF}	(Note 5)	1700		2200	MHz
LO Frequency	f_{LO}	(Note 5)	1750		2700	MHz
IF Frequency	f_{IF}	Using Mini-Circuits TC4-1W-17 4:1 transformer as defined in the <i>Typical Application Circuit</i> , IF matching components affect the IF frequency range (Note 5)	100		500	MHz
		Using alternative Mini-Circuits TC4-1W-7A 4:1 transformer as defined in the <i>Typical Application Circuit</i> , IF matching components affect the IF frequency range (Note 5)	50		250	
LO Drive Level	P_{LO}		-3		+3	dBm

5.0V SUPPLY AC ELECTRICAL CHARACTERISTICS

(*Typical Application Circuit*, $R1 = R4 = 681\Omega$, $R2 = R5 = 1.5k\Omega$, $V_{CC} = 4.75V$ to $5.25V$, RF and LO ports are driven from 50Ω sources, $P_{LO} = -3dBm$ to $+3dBm$, $P_{RF} = -5dBm$, $f_{RF} = 1700MHz$ to $2000MHz$, $f_{LO} = 2050MHz$ to $2350MHz$, $f_{IF} = 350MHz$, $f_{RF} < f_{LO}$, $T_C = -40^\circ C$ to $+85^\circ C$. Typical values are at $V_{CC} = 5.0V$, $P_{RF} = -5dBm$, $P_{LO} = 0dBm$, $f_{RF} = 1850MHz$, $f_{LO} = 2200MHz$, $f_{IF} = 350MHz$, $T_C = +25^\circ C$. All parameters are guaranteed by design and characterization, unless otherwise noted.) (Note 6)

PARAMETER	SYMBOL	CONDITIONS	MIN	TYP	MAX	UNITS
Conversion Gain	G_C		6.5	8.7	10.4	dB
		$T_C = +25^\circ C$ (Note 7)	7.1	8.7	9.9	
		$T_C = +25^\circ C$, $f_{RF} = 1850MHz$ (Note 8)	7.7	8.7	9.7	
Conversion Gain Flatness	ΔG_C	Flatness over any one of three frequency bands: $f_{RF} = 1710MHz$ to $1785MHz$		+0.07		dB
		$f_{RF} = 1850MHz$ to $1910MHz$		-0.03		
		$f_{RF} = 1920MHz$ to $1980MHz$		-0.13		
Gain Variation Over Temperature	TC_{CG}	$f_{RF} = 1700MHz$ to $2000MHz$, $f_{LO} = 2050MHz$ to $2350MHz$, $T_C = -40^\circ C$ to $+85^\circ C$		-0.011		dB/ $^\circ C$
Input Compression Point	IP_{1dB}	$f_{RF} = 1850MHz$ (Notes 7, 9)	9.5	13.5		dBm
Input Third-Order Intercept Point	$IIP3$	$f_{RF1} - f_{RF2} = 1MHz$, $P_{RF} = -5dBm$ per tone	21.5	24.8		dBm
		$f_{RF1} - f_{RF2} = 1MHz$, $P_{RF} = -5dBm$ per tone, $T_C = +25^\circ C$	22	24.8		
Input Third-Order Intercept Point Variation Over Temperature	TC_{IIP3}	$f_{RF1} - f_{RF2} = 1MHz$, $P_{RF} = -5dBm$ per tone, $T_C = -40^\circ C$ to $+85^\circ C$		0.006		dBm/ $^\circ C$
Noise Figure (Note 10)	NF_{SSB}	Single sideband, no blockers present		9.2	11.1	dB
		$f_{RF} = 1850MHz$, $f_{LO} = 2200MHz$, $T_C = +25^\circ C$, $P_{LO} = 0dBm$, single sideband, no blockers present		9.2	9.8	
Noise Figure Temperature Coefficient	TC_{NF}	Single sideband, no blockers present, $T_C = -40^\circ C$ to $+85^\circ C$		0.016		dB/ $^\circ C$

双通道、SiGe、高线性度、1700MHz至2200MHz 下变频混频器，带有LO缓冲器/开关

MAX19995A

5.0V SUPPLY AC ELECTRICAL CHARACTERISTICS (continued)

(Typical Application Circuit, R1 = R4 = 681Ω, R2 = R5 = 1.5kΩ, V_{CC} = 4.75V to 5.25V, RF and LO ports are driven from 50Ω sources, P_{LO} = -3dBm to +3dBm, P_{RF} = -5dBm, f_{RF} = 1700MHz to 2000MHz, f_{LO} = 2050MHz to 2350MHz, f_{IF} = 350MHz, f_{RF} < f_{LO}, T_C = -40°C to +85°C. Typical values are at V_{CC} = 5.0V, P_{RF} = -5dBm, P_{LO} = 0dBm, f_{RF} = 1850MHz, f_{LO} = 2200MHz, f_{IF} = 350MHz, T_C = +25°C. All parameters are guaranteed by design and characterization, unless otherwise noted.) (Note 6)

PARAMETER	SYMBOL	CONDITIONS	MIN	TYP	MAX	UNITS
Noise Figure with Blocker	N _{FB}	P _{BLOCKER} = +8dBm, f _{RF} = 1850MHz, f _{LO} = 2200MHz, f _{BLOCKER} = 1725MHz, P _{LO} = 0dBm, V _{CC} = 5.0V, T _C = +25°C (Notes 10, 11)		19.7	23.4	dB
2LO-2RF Spur Rejection (Note 10)	2 x 2	f _{RF} = 1850MHz, f _{LO} = 2200MHz, f _{SPUR} = 2025MHz	P _{RF} = -10dBm	54	64	dBc
			P _{RF} = -5dBm	49	59	
		f _{RF} = 1850MHz, f _{LO} = 2200MHz, f _{SPUR} = 2025MHz, P _{LO} = 0dBm, V _{CC} = 5.0V, T _C = +25°C	P _{RF} = -10dBm	57	64	
			P _{RF} = -5dBm	52	59	
3LO-3RF Spur Rejection (Note 10)	3 x 3	f _{RF} = 1850MHz, f _{LO} = 2200MHz, f _{SPUR} = 2083.33MHz	P _{RF} = -10dBm	70	80	dBc
			P _{RF} = -5dBm	60	70	
		f _{RF} = 1850MHz, f _{LO} = 2200MHz, f _{SPUR} = 2083.33MHz, P _{LO} = 0dBm, V _{CC} = 5.0V, T _C = +25°C	P _{RF} = -10dBm	71	80	
			P _{RF} = -5dBm	61	70	
RF Input Return Loss		LO and IF terminated into matched impedance, LO on		21		dB
LO Input Return Loss		LO port selected, RF and IF terminated into matched impedance		20		dB
		LO port unselected, RF and IF terminated into matched impedance		22		
IF Output Impedance	Z _{IF}	Nominal differential impedance of the IF outputs		200		Ω
IF Output Return Loss		RF terminated into 50Ω, LO driven by 50Ω source, IF transformed to 50Ω using external components shown in the <i>Typical Application Circuit</i>		11.5		dB
RF-to-IF Isolation		(Note 8)	31	35		dB
LO Leakage at RF Port		(Note 8)		-35	-25	dBm
2LO Leakage at RF Port		(Note 8)		-17.5	-14	dBm
LO Leakage at IF Port		(Note 8)		-32	-22	dBm

双通道、SiGe、高线性度、1700MHz至2200MHz 下变频混频器，带有LO缓冲器/开关

MAX19995A

5.0V SUPPLY AC ELECTRICAL CHARACTERISTICS (continued)

(Typical Application Circuit, R1 = R4 = 681Ω, R2 = R5 = 1.5kΩ, V_{CC} = 4.75V to 5.25V, RF and LO ports are driven from 50Ω sources, P_{LO} = -3dBm to +3dBm, P_{RF} = -5dBm, f_{RF} = 1700MHz to 2000MHz, f_{LO} = 2050MHz to 2350MHz, f_{IF} = 350MHz, f_{RF} < f_{LO}, T_C = -40°C to +85°C. Typical values are at V_{CC} = 5.0V, P_{RF} = -5dBm, P_{LO} = 0dBm, f_{RF} = 1850MHz, f_{LO} = 2200MHz, f_{IF} = 350MHz, T_C = +25°C. All parameters are guaranteed by design and characterization, unless otherwise noted.) (Note 6)

PARAMETER	SYMBOL	CONDITIONS	MIN	TYP	MAX	UNITS
Channel Isolation (Note 7)		RFMAIN converted power measured at IFDIV relative to IFMAIN, all unused ports terminated to 50Ω	40	48		dB
		RFDIV converted power measured at IFMAIN relative to IFDIV, all unused ports terminated to 50Ω	40	48		
LO-to-LO Isolation		P _{LO1} = +3dBm, P _{LO2} = +3dBm, f _{LO1} = 2200MHz, f _{LO2} = 2201MHz (Note 7)	40	48		dB
LO Switching Time		50% of LOSEL to IF settled within 2 degrees		50		ns

3.3V SUPPLY AC ELECTRICAL CHARACTERISTICS

(Typical Application Circuit, R1 = R4 = 909Ω, R2 = R5 = 1kΩ. Typical values are at V_{CC} = 3.3V, P_{RF} = -5dBm, P_{LO} = 0dBm, f_{RF} = 1850MHz, f_{LO} = 2200MHz, f_{IF} = 350MHz, T_C = +25°C, unless otherwise noted.) (Note 6)

PARAMETER	SYMBOL	CONDITIONS	MIN	TYP	MAX	UNITS
Conversion Gain	G _C	(Note 8)		8.4		dB
Conversion Gain Flatness	ΔG _C	Flatness over any one of three frequency bands: f _{RF} = 1710MHz to 1785MHz		+0.07		dB
		f _{RF} = 1850MHz to 1910MHz		-0.03		
		f _{RF} = 1920MHz to 1980MHz		-0.13		
Gain Variation Over Temperature	T _{CCG}	T _C = -40°C to +85°C		-0.013		dB/°C
Input Compression Point	IP _{1dB}	(Note 9)		10.2		dBm
Input Third-Order Intercept Point	IIP ₃	f _{RF1} - f _{RF2} = 1MHz		22.5		dBm
Input Third-Order Intercept Point Variation Over Temperature	T _C IIP ₃	f _{RF1} - f _{RF2} = 1MHz, P _{RF} = -5dBm per tone, T _C = -40°C to +85°C		0.0017		dBm/°C
Noise Figure	NF _{SSB}	Single sideband, no blockers present		9		dB
Noise Figure Temperature Coefficient	T _C NF	Single sideband, no blockers present, T _C = -40°C to +85°C		0.016		dB/°C
2LO-2RF Spur Rejection	2 x 2	P _{RF} = -10dBm		65		dBc
		P _{RF} = -5dBm		60		
3LO-3RF Spur Rejection	3 x 3	P _{RF} = -10dBm		77		dBc
		P _{RF} = -5dBm		67		
RF Input Return Loss		LO and IF terminated into matched impedance, LO on		25		dB

双通道、SiGe、高线性度、1700MHz至2200MHz 下变频混频器，带有LO缓冲器/开关

MAX19995A

3.3V SUPPLY AC ELECTRICAL CHARACTERISTICS (continued)

(Typical Application Circuit, R1 = R4 = 909Ω, R2 = R5 = 1kΩ. Typical values are at V_{CC} = 3.3V, P_{RF} = -5dBm, P_{LO} = 0dBm, f_{RF} = 1850MHz, f_{LO} = 2200MHz, f_{IF} = 350MHz, T_C = +25°C, unless otherwise noted.) (Note 6)

PARAMETER	SYMBOL	CONDITIONS	MIN	TYP	MAX	UNITS
LO Input Return Loss		LO port selected, RF and IF terminated into matched impedance		22		dB
		LO port unselected, RF and IF terminated into matched impedance		16		
IF Output Return Loss		RF terminated into 50Ω, LO driven by 50Ω source, IF transformed to 50Ω using external components shown in the <i>Typical Application Circuit</i>		11.5		dB
RF-to-IF Isolation				36		dB
LO Leakage at RF Port				-40		dBm
2LO Leakage at RF Port				-23		dBm
LO Leakage at IF Port				-37		dBm
Channel Isolation		RFMAIN converted power measured at IFDIV relative to IFMAIN, all unused ports terminated to 50Ω		48		dB
		RFDIV converted power measured at IFMAIN relative to IFDIV, all unused ports terminated to 50Ω		48		
LO-to-LO Isolation		P _{LO1} = +3dBm, P _{LO2} = +3dBm, f _{LO1} = 2200MHz, f _{LO2} = 2201MHz		47		dB
LO Switching Time		50% of LOSEL to IF settled within 2 degrees		50		ns

Note 5: Not production tested. Operation outside this range is possible, but with degraded performance of some parameters. See the *Typical Operating Characteristics*.

Note 6: All limits reflect losses of external components, including a 0.9dB loss at f_{IF} = 350MHz due to the 4:1 transformer. Output measurements were taken at IF outputs of the *Typical Application Circuit*.

Note 7: 100% production tested.

Note 8: 100% production tested for functionality.

Note 9: Maximum reliable continuous input power applied to the RF or IF port of this device is +12dBm from a 50Ω source.

Note 10: Not production tested.

Note 11: Measured with external LO source noise filtered so the noise floor is -174dBm/Hz. This specification reflects the effects of all SNR degradations in the mixer, including the LO noise as defined in Application Note 2021: *Specifications and Measurement of Local Oscillator Noise in Integrated Circuit Base Station Mixers*.

双通道、SiGe、高线性度、1700MHz至2200MHz 下变频混频器，带有LO缓冲器/开关

典型工作特性

(Typical Application Circuit, $R_1 = R_4 = 681\Omega$, $R_2 = R_5 = 1.5k\Omega$, $V_{CC} = 5.0V$, $P_{RF} = -5dBm$, $P_{LO} = 0dBm$, $f_{RF} = 1850MHz$, $f_{LO} = 2200MHz$, $f_{IF} = 350MHz$, $T_C = +25^\circ C$, unless otherwise noted.)

MAX19995A

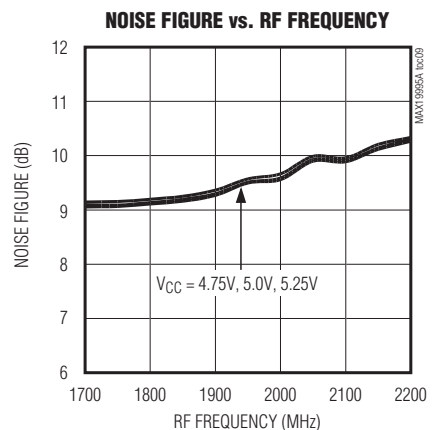
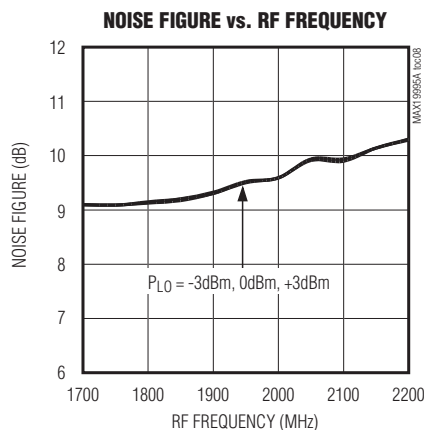
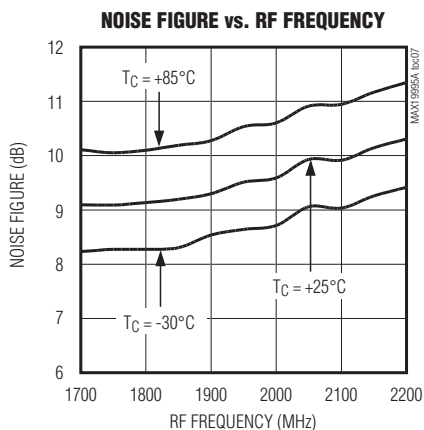
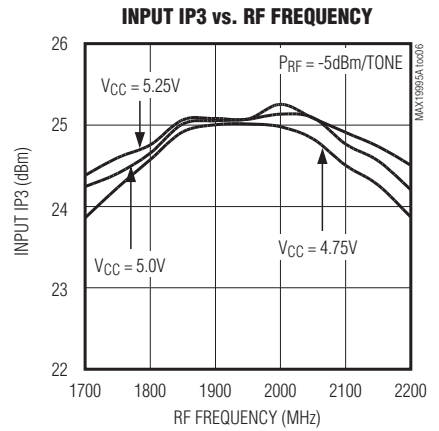
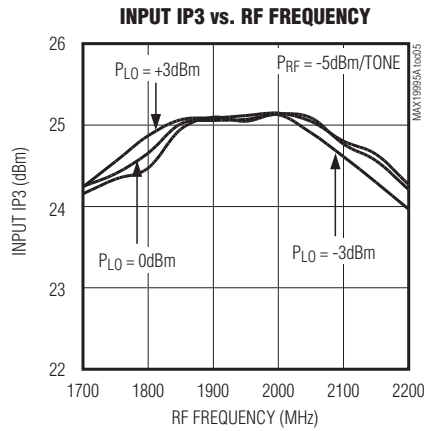
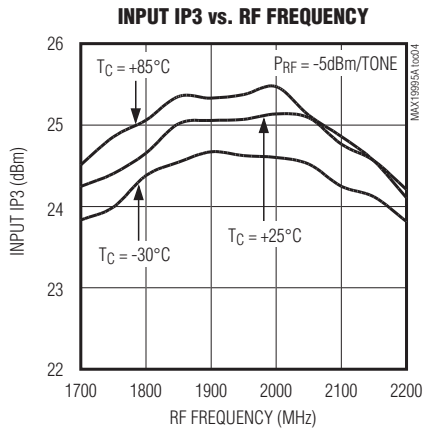
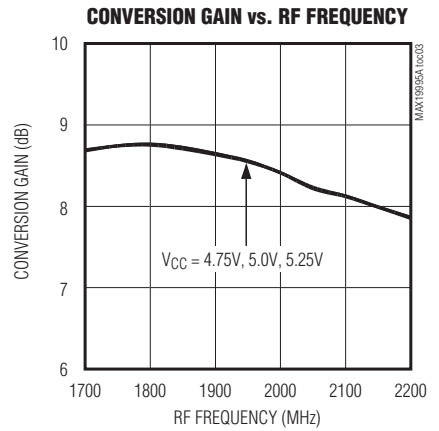
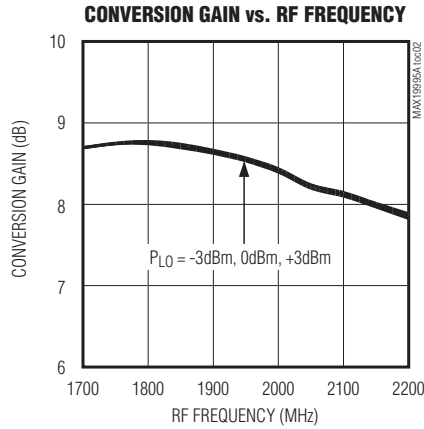
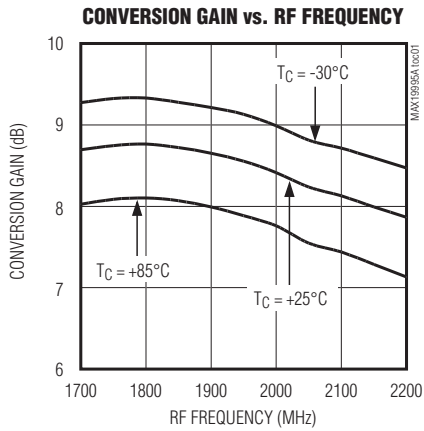

双通道、SiGe、高线性度、1700MHz至2200MHz 下变频混频器，带有LO缓冲器/开关

典型工作特性(续)

(Typical Application Circuit, $R_1 = R_4 = 681\Omega$, $R_2 = R_5 = 1.5k\Omega$, $V_{CC} = 5.0V$, $P_{RF} = -5dBm$, $P_{LO} = 0dBm$, $f_{RF} = 1850MHz$, $f_{LO} = 2200MHz$, $f_{IF} = 350MHz$, $T_C = +25^\circ C$, unless otherwise noted.)

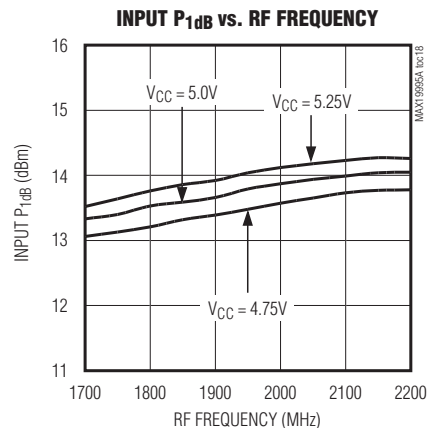
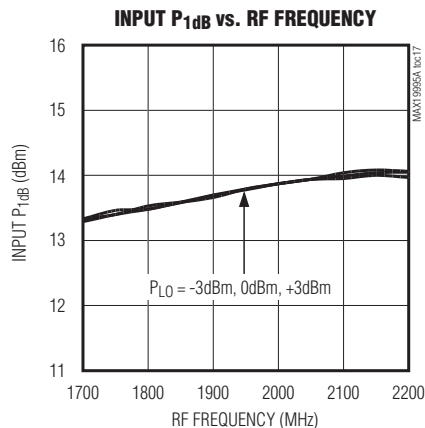
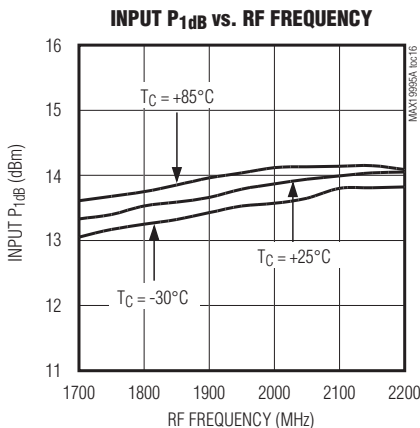
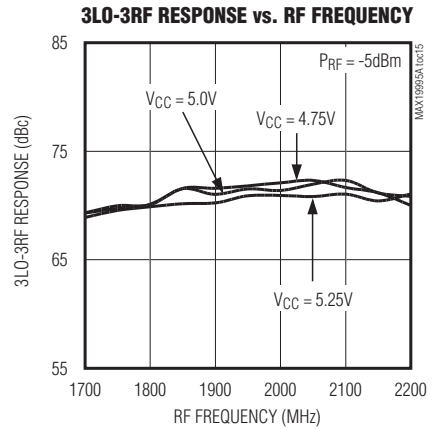
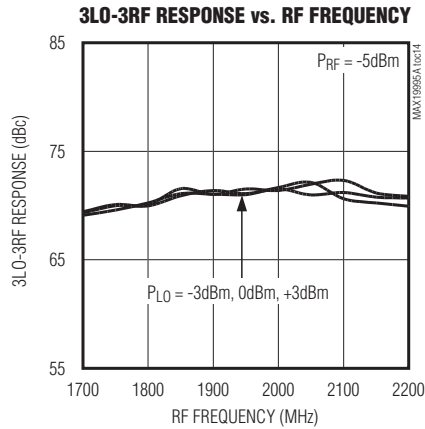
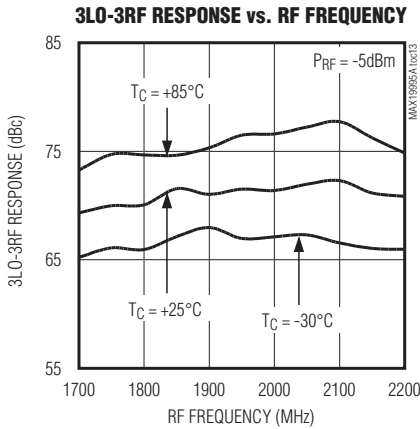
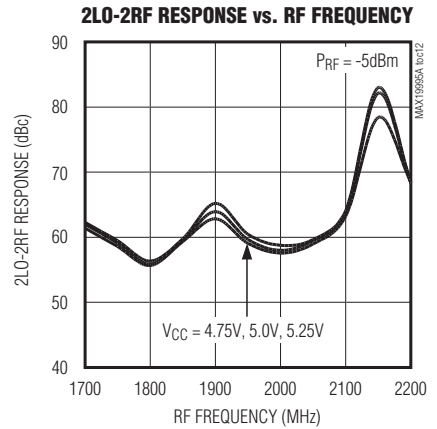
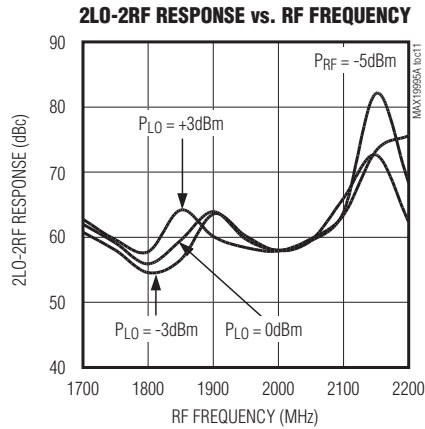
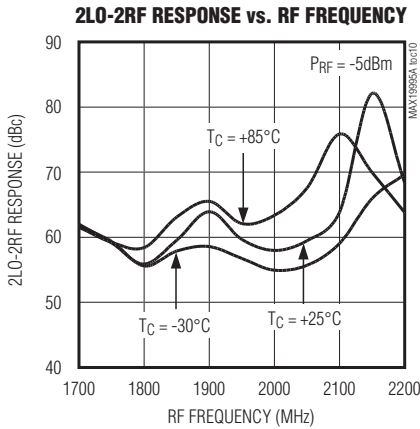

双通道、SiGe、高线性度、1700MHz至2200MHz 下变频混频器，带有LO缓冲器/开关

典型工作特性(续)

(Typical Application Circuit, $R_1 = R_4 = 681\Omega$, $R_2 = R_5 = 1.5k\Omega$, $V_{CC} = 5.0V$, $P_{RF} = -5dBm$, $P_{LO} = 0dBm$, $f_{RF} = 1850MHz$, $f_{LO} = 2200MHz$, $f_{IF} = 350MHz$, $T_C = +25^\circ C$, unless otherwise noted.)

MAX19995A

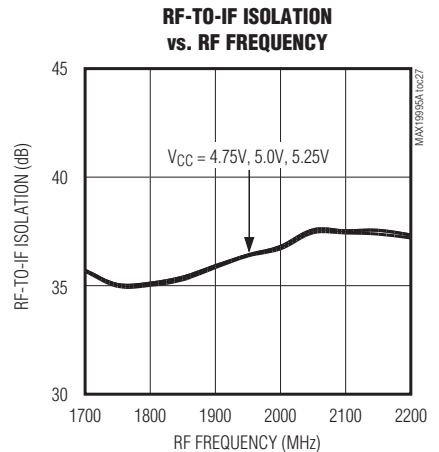
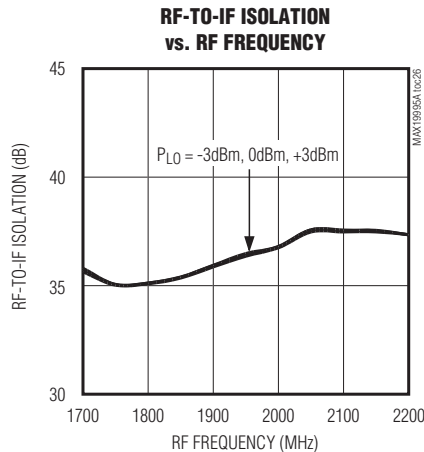
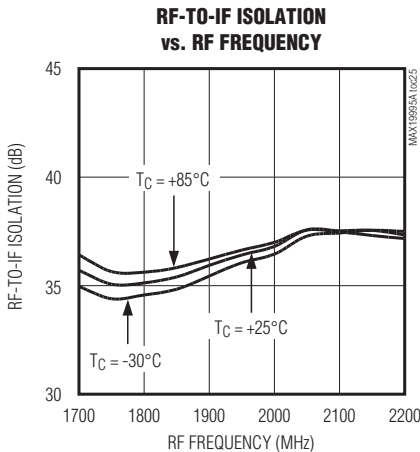
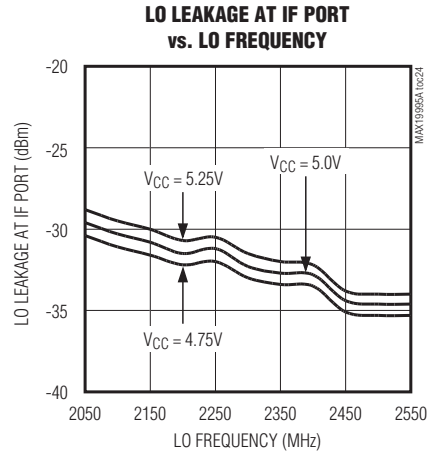
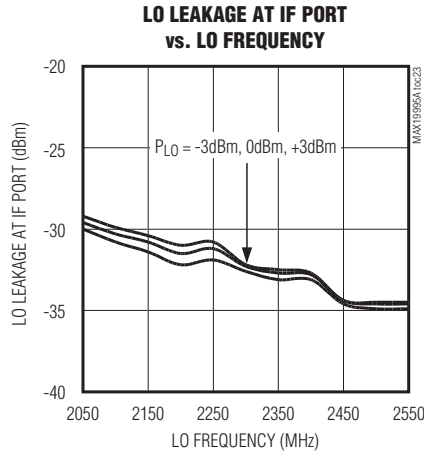
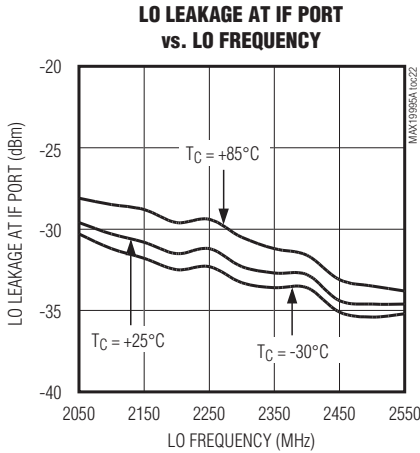
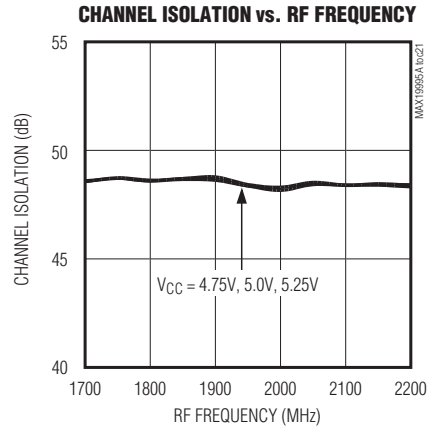
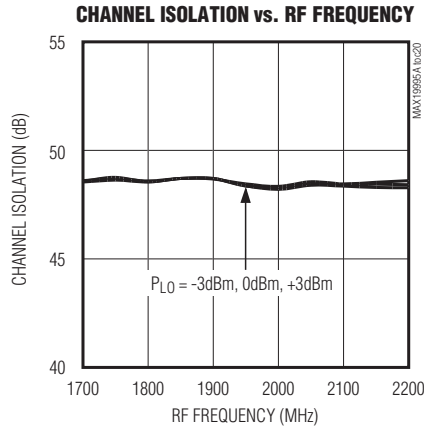
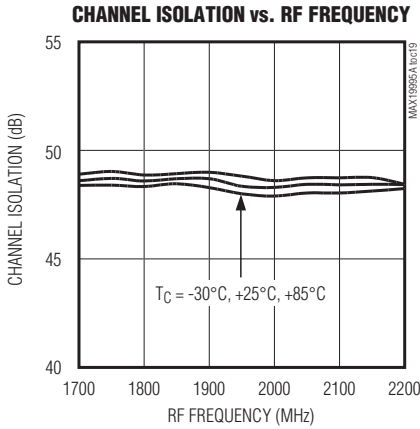

双通道、SiGe、高线性度、1700MHz至2200MHz 下变频混频器，带有LO缓冲器/开关

典型工作特性(续)

(Typical Application Circuit, $R_1 = R_4 = 681\Omega$, $R_2 = R_5 = 1.5k\Omega$, $V_{CC} = 5.0V$, $P_{RF} = -5dBm$, $P_{LO} = 0dBm$, $f_{RF} = 1850MHz$, $f_{LO} = 2200MHz$, $f_{IF} = 350MHz$, $T_C = +25^\circ C$, unless otherwise noted.)

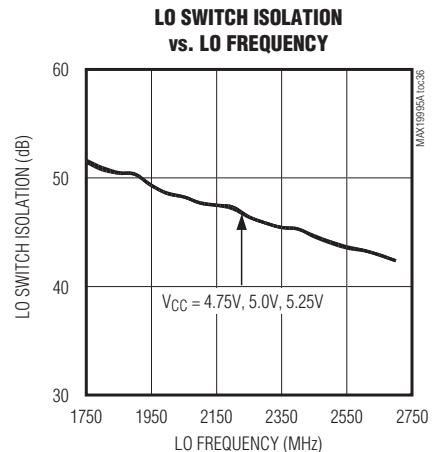
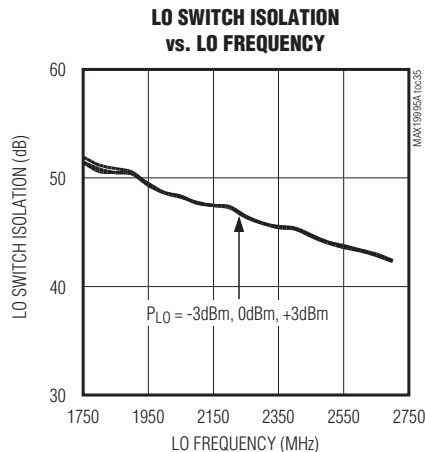
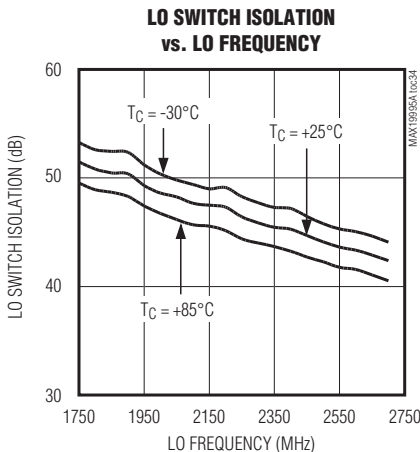
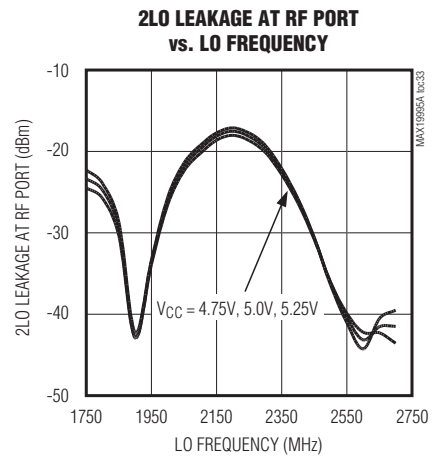
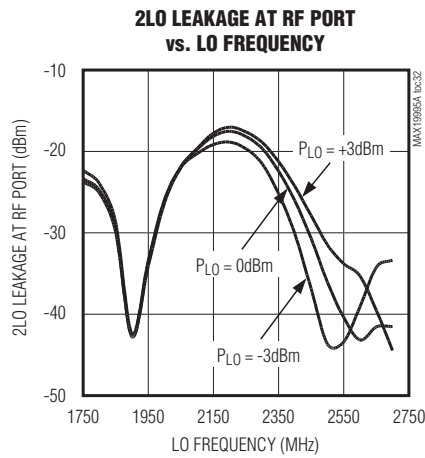
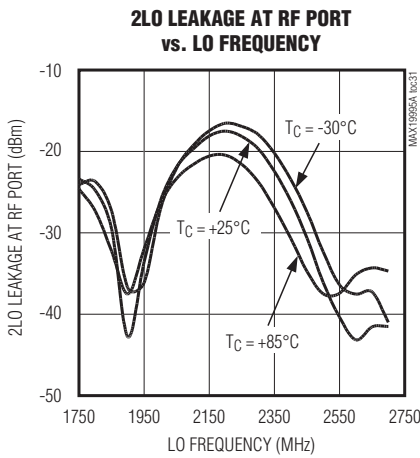
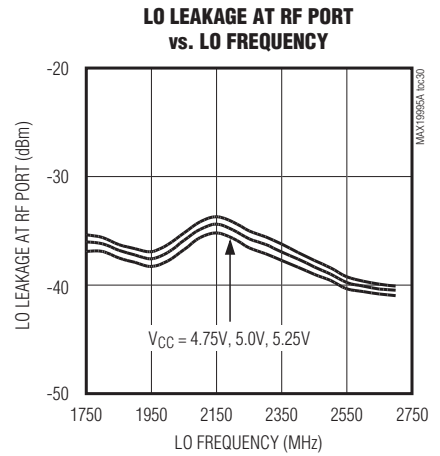
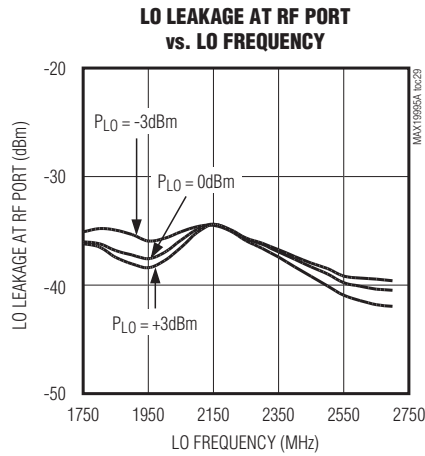
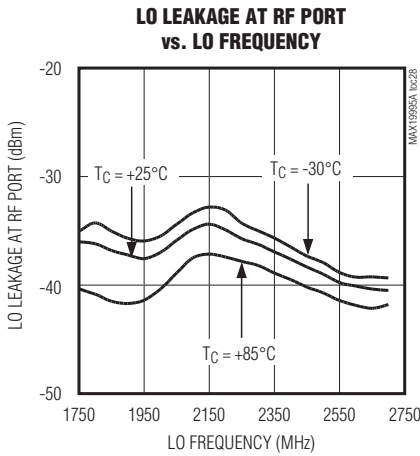

双通道、SiGe、高线性度、1700MHz至2200MHz 下变频混频器，带有LO缓冲器/开关

典型工作特性(续)

(Typical Application Circuit, $R_1 = R_4 = 681\Omega$, $R_2 = R_5 = 1.5k\Omega$, $V_{CC} = 5.0V$, $P_{RF} = -5dBm$, $P_{LO} = 0dBm$, $f_{RF} = 1850MHz$, $f_{LO} = 2200MHz$, $f_{IF} = 350MHz$, $T_C = +25^\circ C$, unless otherwise noted.)

MAX19995A

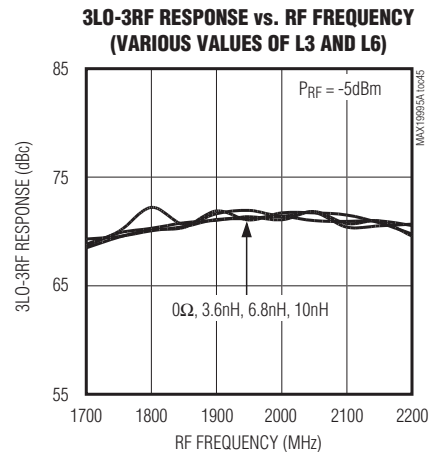
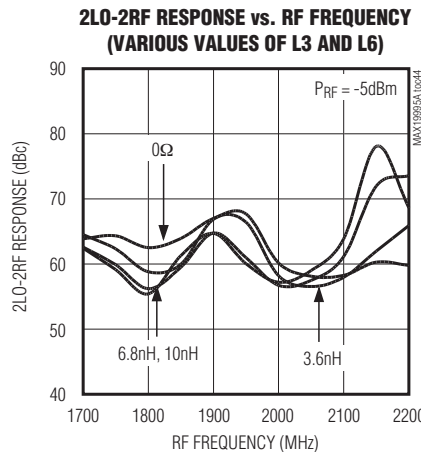
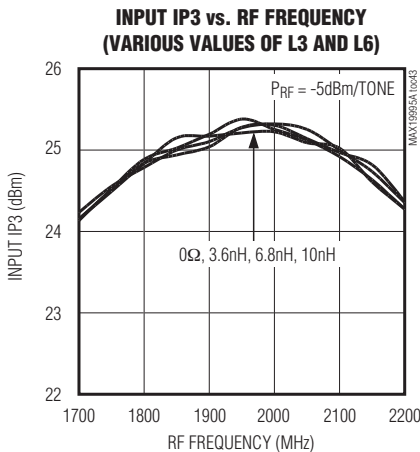
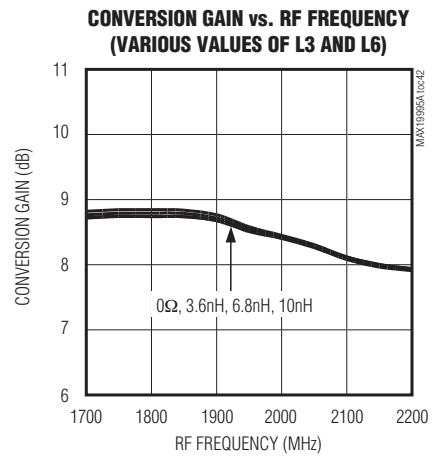
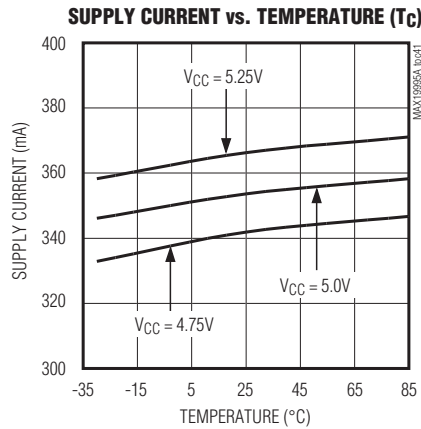
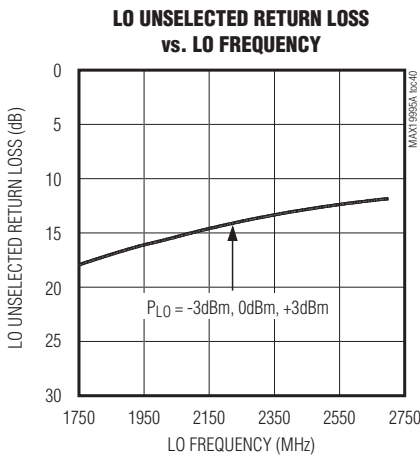
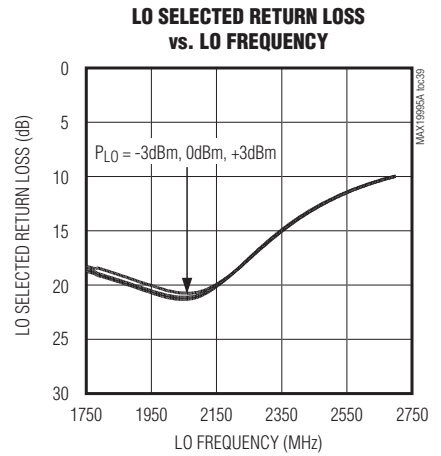
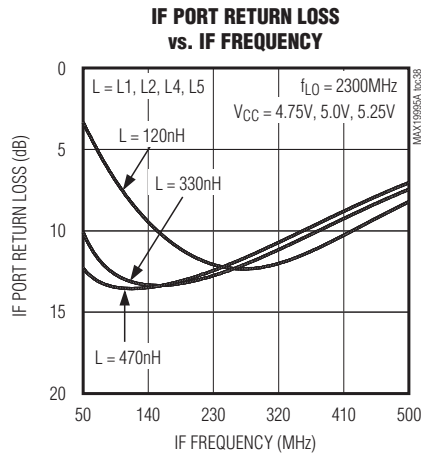
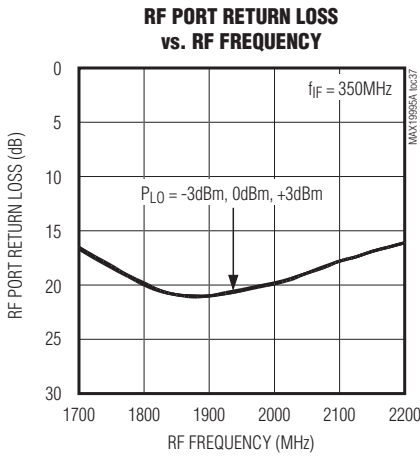

双通道、SiGe、高线性度、1700MHz至2200MHz 下变频混频器，带有LO缓冲器/开关

典型工作特性(续)

(Typical Application Circuit, $R1 = R4 = 681\Omega$, $R2 = R5 = 1.5k\Omega$, $V_{CC} = 5.0V$, $P_{RF} = -5dBm$, $P_{LO} = 0dBm$, $f_{RF} = 1850MHz$, $f_{LO} = 2200MHz$, $f_{IF} = 350MHz$, $T_C = +25^\circ C$, unless otherwise noted.)

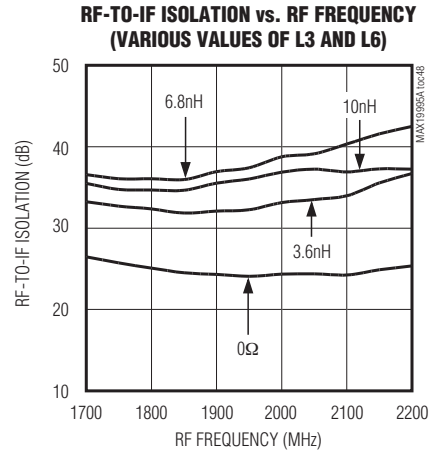
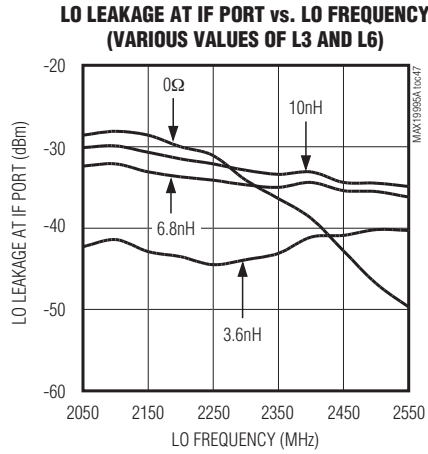
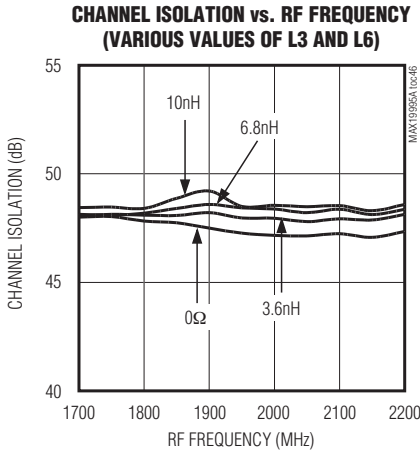

双通道、SiGe、高线性度、1700MHz至2200MHz 下变频混频器，带有LO缓冲器/开关

典型工作特性(续)

(Typical Application Circuit, $R_1 = R_4 = 909\Omega$, $R_2 = R_5 = 1k\Omega$, $V_{CC} = 3.3V$, $P_{RF} = -5dBm$, $P_{LO} = 0dBm$, $f_{RF} = 1850MHz$, $f_{LO} = 2200MHz$, $f_{IF} = 350MHz$, $T_C = +25^\circ C$, unless otherwise noted.)

MAX19995A

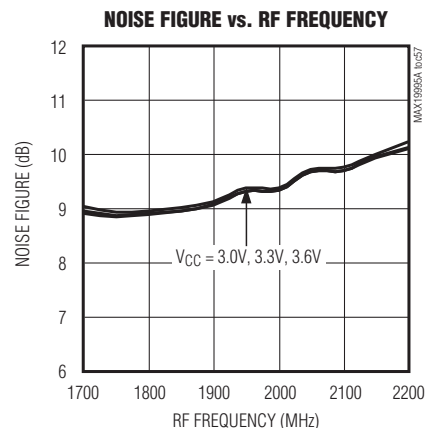
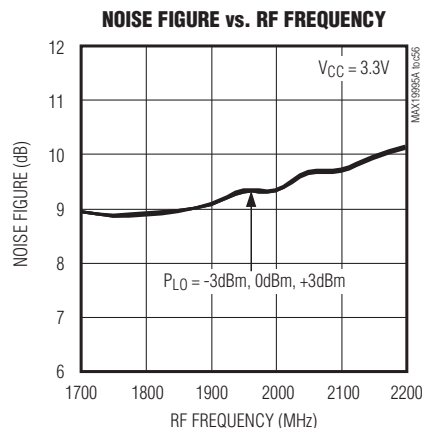
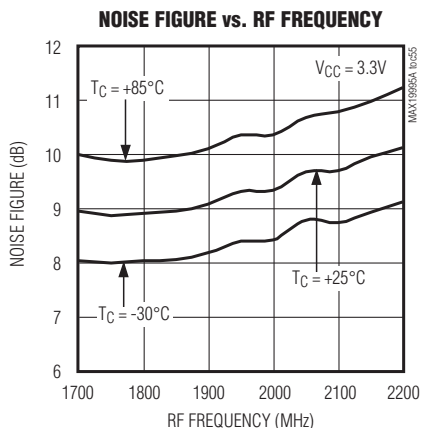
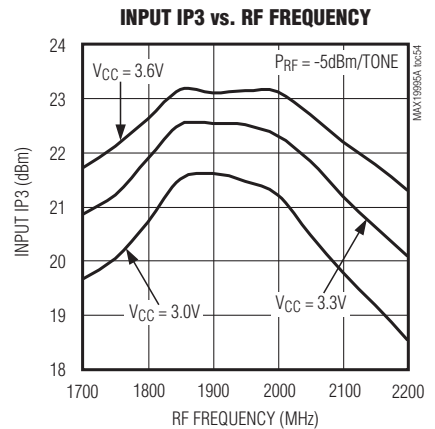
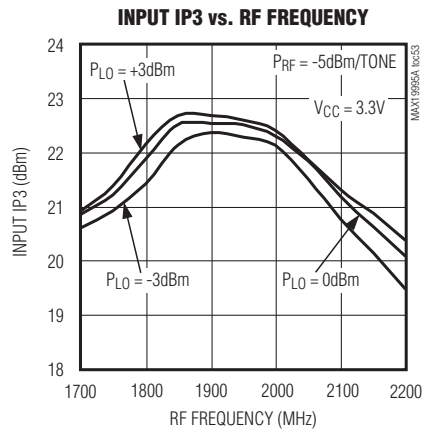
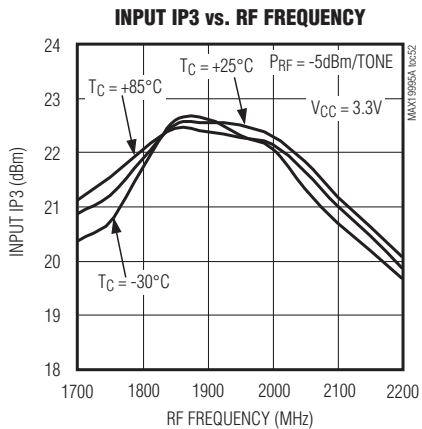
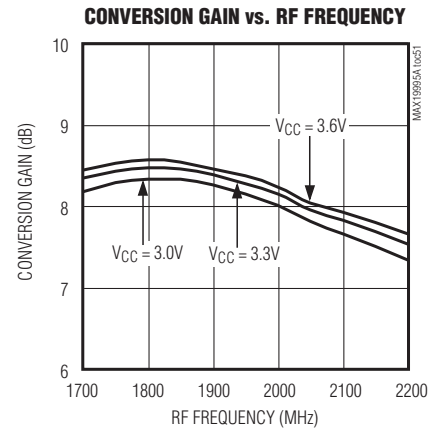
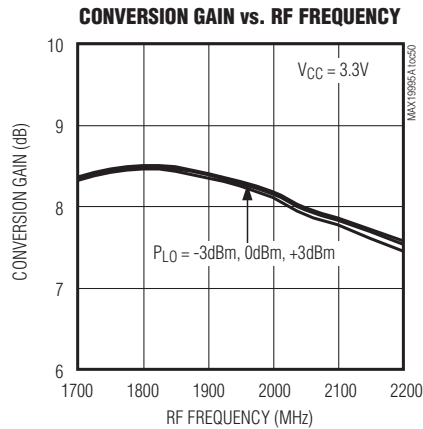
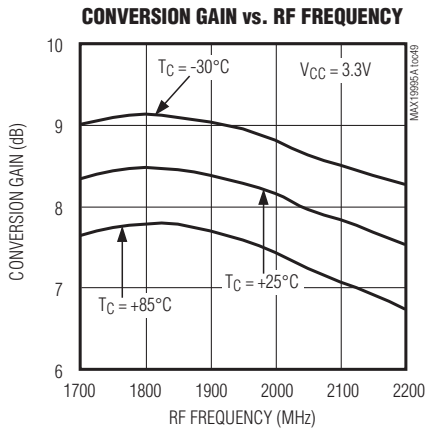

双通道、SiGe、高线性度、1700MHz至2200MHz 下变频混频器，带有LO缓冲器/开关

典型工作特性(续)

(Typical Application Circuit, $R_1 = R_4 = 909\Omega$, $R_2 = R_5 = 1k\Omega$, $V_{CC} = 3.3V$, $P_{RF} = -5dBm$, $P_{LO} = 0dBm$, $f_{RF} = 1850MHz$, $f_{LO} = 2200MHz$, $f_{IF} = 350MHz$, $T_C = +25^\circ C$, unless otherwise noted.)

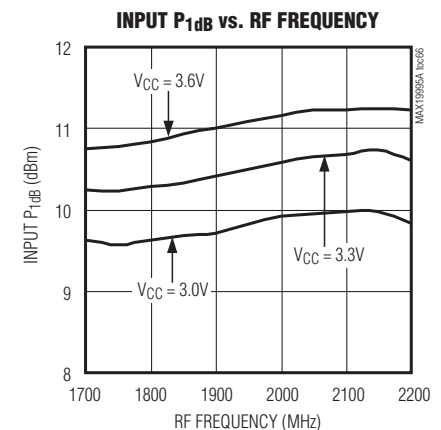
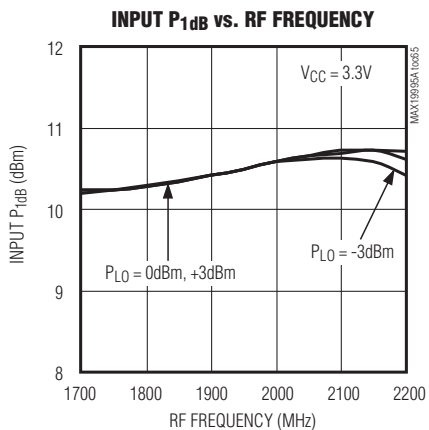
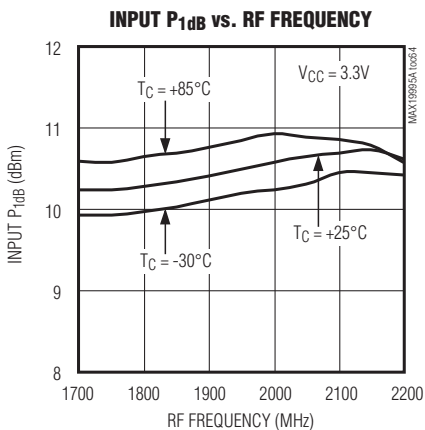
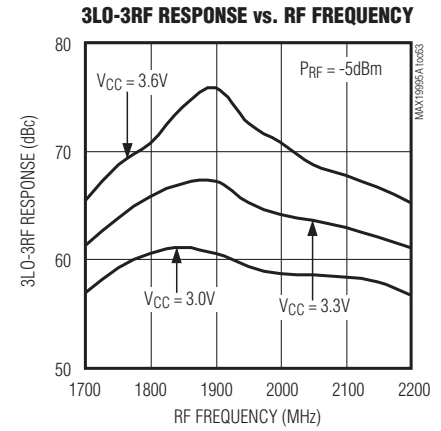
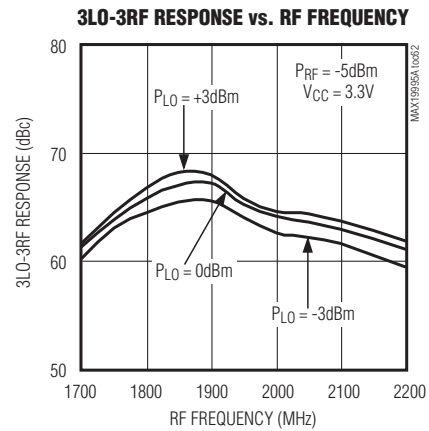
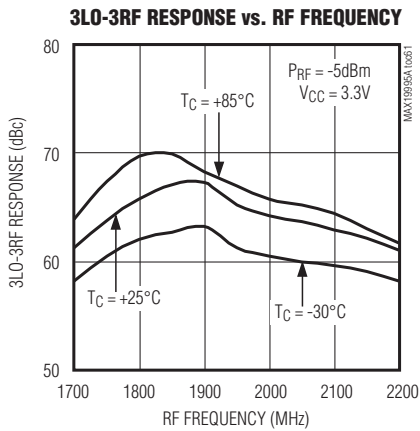
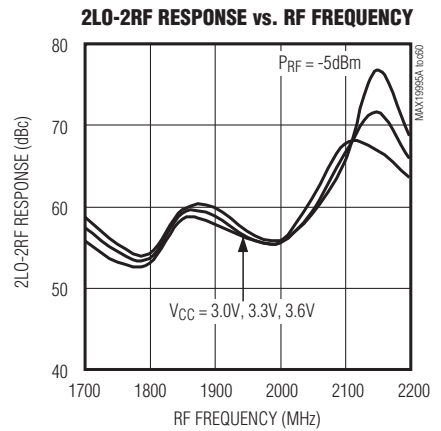
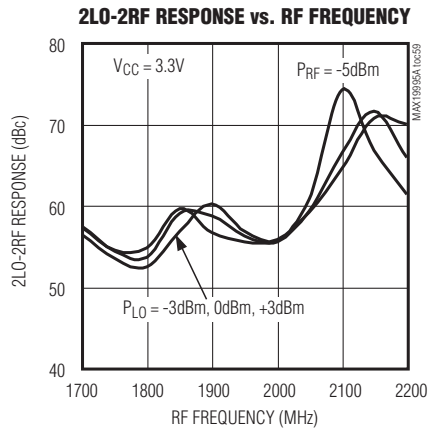
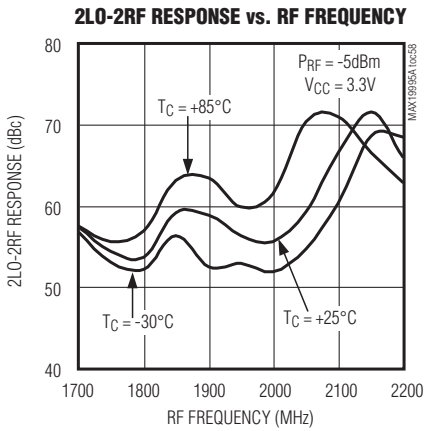

双通道、SiGe、高线性度、1700MHz至2200MHz 下变频混频器，带有LO缓冲器/开关

典型工作特性(续)

(Typical Application Circuit, $R_1 = R_4 = 909\Omega$, $R_2 = R_5 = 1k\Omega$, $V_{CC} = 3.3V$, $P_{RF} = -5dBm$, $P_{LO} = 0dBm$, $f_{RF} = 1850MHz$, $f_{LO} = 2200MHz$, $f_{IF} = 350MHz$, $T_C = +25^\circ C$, unless otherwise noted.)

MAX19995A

CHANNEL ISOLATION vs. RF FREQUENCY

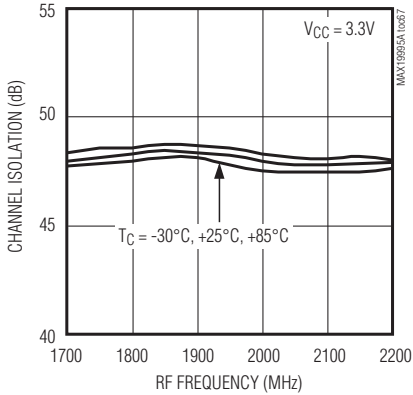

CHANNEL ISOLATION vs. RF FREQUENCY

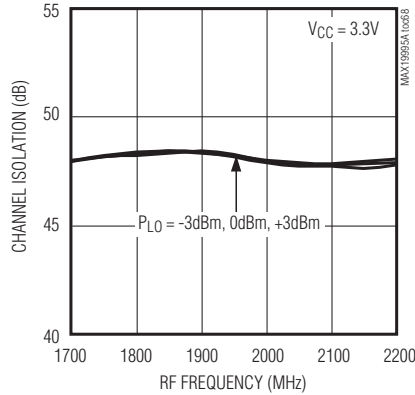

CHANNEL ISOLATION vs. RF FREQUENCY

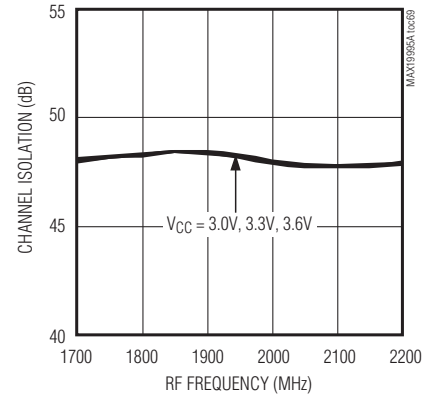

LO LEAKAGE AT IF PORT vs. LO FREQUENCY

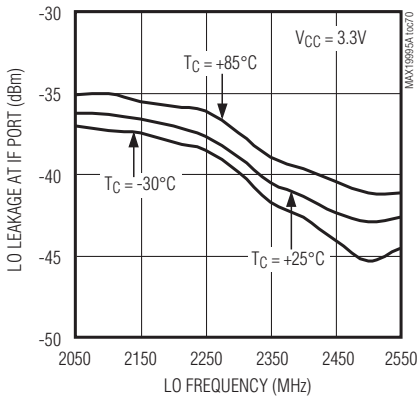

LO LEAKAGE AT IF PORT vs. LO FREQUENCY

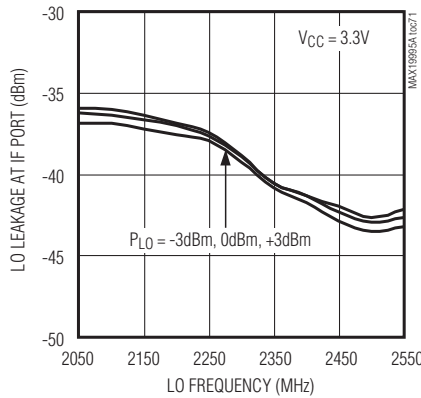

LO LEAKAGE AT IF PORT vs. LO FREQUENCY

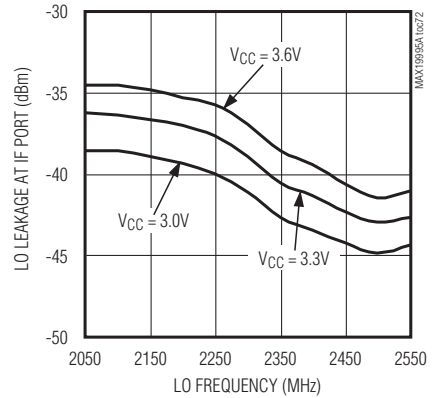

RF-TO-IF ISOLATION vs. RF FREQUENCY

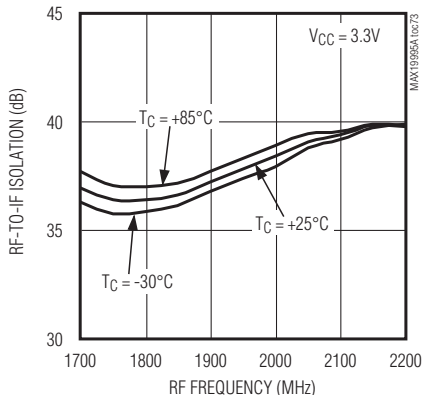

RF-TO-IF ISOLATION vs. RF FREQUENCY

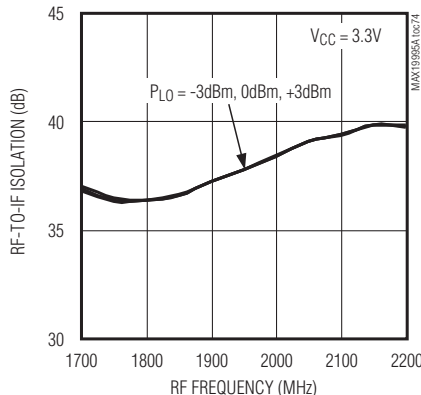

RF-TO-IF ISOLATION vs. RF FREQUENCY

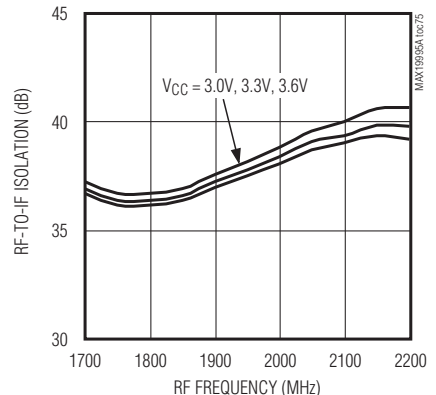

双通道、SiGe、高线性度、1700MHz至2200MHz 下变频混频器，带有LO缓冲器/开关

典型工作特性(续)

(Typical Application Circuit, $R_1 = R_4 = 909\Omega$, $R_2 = R_5 = 1k\Omega$, $V_{CC} = 3.3V$, $P_{RF} = -5dBm$, $P_{LO} = 0dBm$, $f_{RF} = 1850MHz$, $f_{LO} = 2200MHz$, $f_{IF} = 350MHz$, $T_C = +25^\circ C$, unless otherwise noted.)

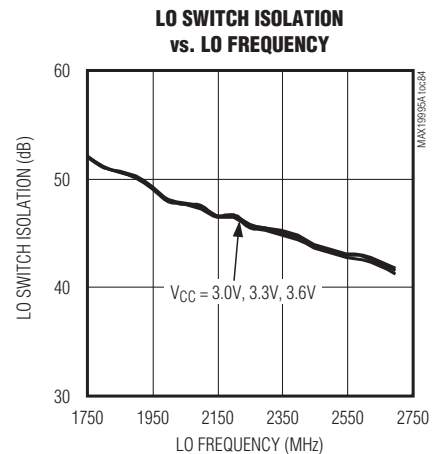
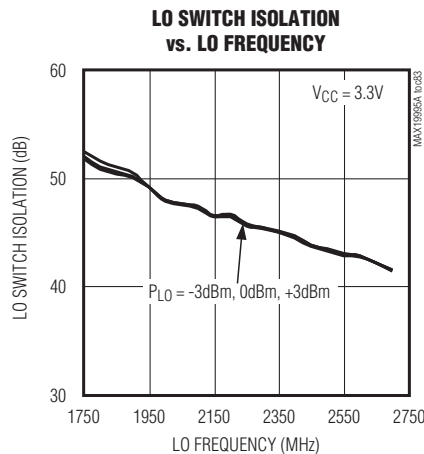
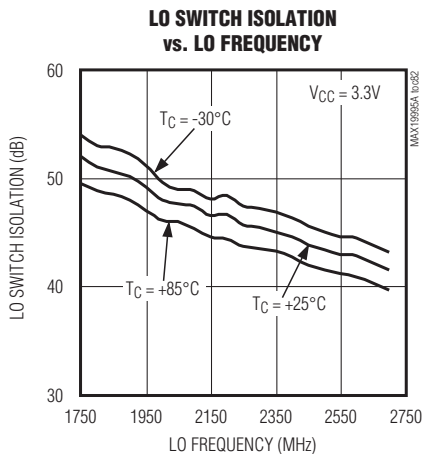
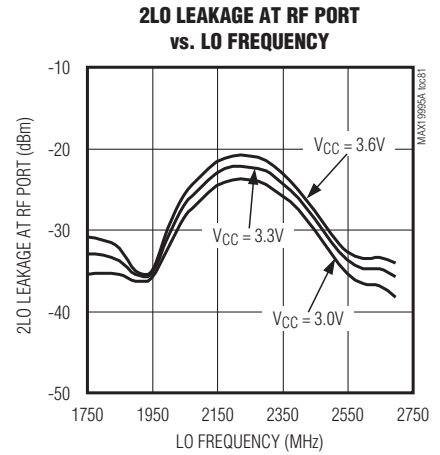
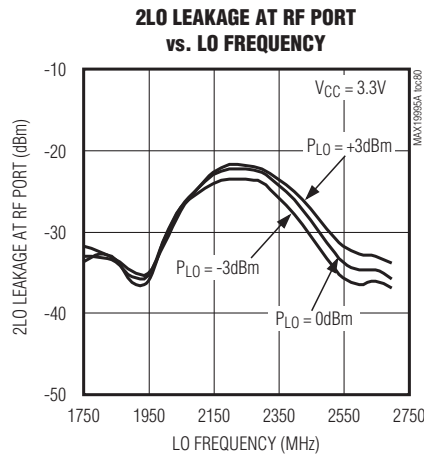
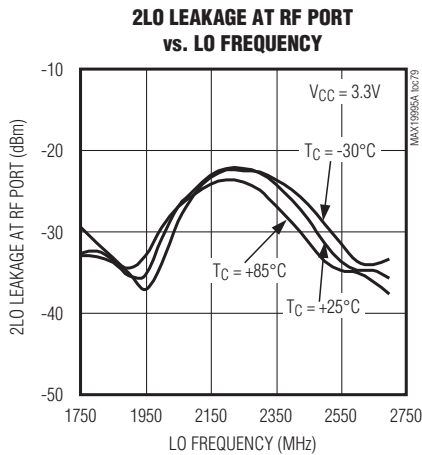
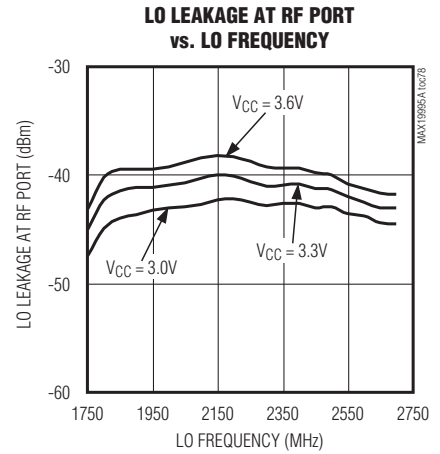
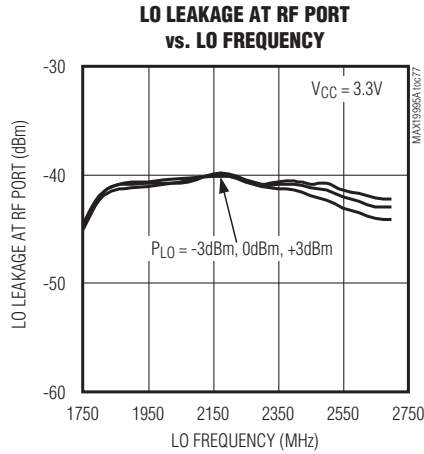
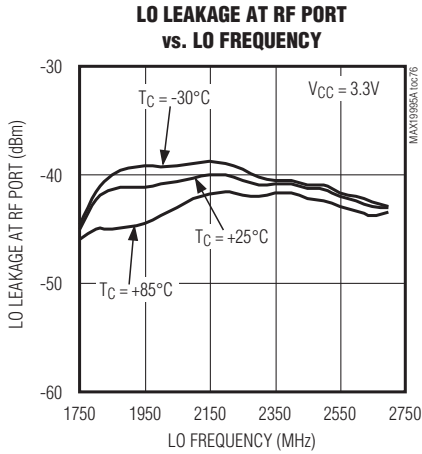

双通道、SiGe、高线性度、1700MHz至2200MHz 下变频混频器，带有LO缓冲器/开关

典型工作特性(续)

(Typical Application Circuit, $R1 = R4 = 909\Omega$, $R2 = R5 = 1k\Omega$, $V_{CC} = 3.3V$, $P_{RF} = -5dBm$, $P_{LO} = 0dBm$, $f_{RF} = 1850MHz$, $f_{LO} = 2200MHz$, $f_{IF} = 350MHz$, $T_C = +25^\circ C$, unless otherwise noted.)

MAX19995A

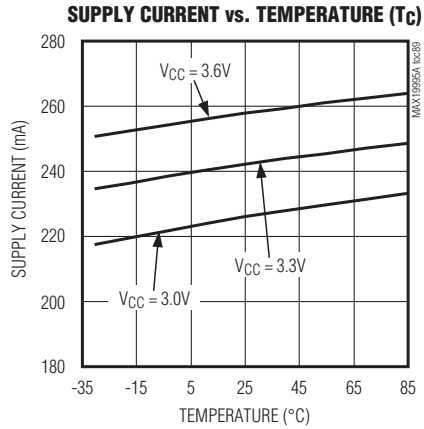
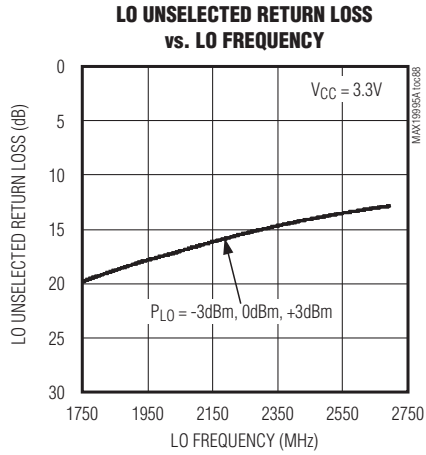
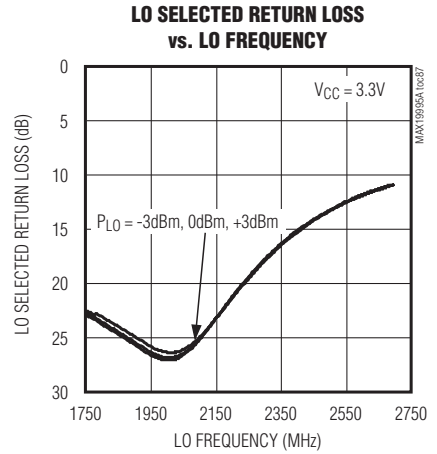
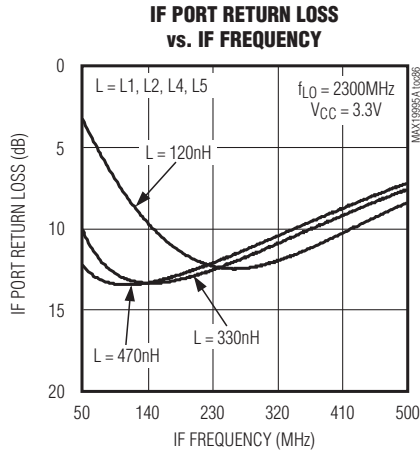
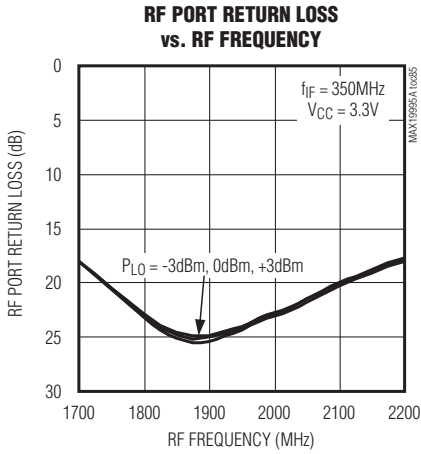

双通道、SiGe、高线性度、1700MHz至2200MHz 下变频混频器，带有LO缓冲器/开关

引脚说明

引脚	名称	功能
1	RFMAIN	主通道RF输入。内部匹配为50Ω，需要一个输入隔直电容。
2	TAPMAIN	主通道非平衡变压器的中间抽头。使用尽可能靠近该引脚放置的39pF和0.033μF电容旁路至GND，容值较小的电容离器件较近。
3, 5, 7, 12, 20, 22, 24, 25, 26, 34	GND	地。
4, 6, 10, 16, 21, 30, 36	VCC	电源，使用典型应用电路所示电容将其旁路至GND，电容应尽可能靠近引脚放置。
8	TAPDIV	分集通道非平衡变压器的中间抽头。使用尽可能靠近该引脚放置的39pF和0.033μF电容旁路至GND，容值较小的电容离器件较近。
9	RFDIV	分集通道RF输入。内部匹配为50Ω，需要一个输入隔直电容。
11	IFD_SET	IF分集放大器的偏置控制。在该引脚与地之间连接一个电阻来设置分集IF放大器的偏置电流(典型性能与电阻值的对应关系请参考典型工作特性)。
13, 14	IFD+, IFD-	分集混频器差分IF输出。各引脚均需通过上拉电感连接至VCC (参见典型应用电路)。
15	IND_EXTD	外部分集电感连接端。该引脚接地，也可以在该引脚与地之间连接一个低ESR的10nH电感，以提高RF与IF之间和LO与IF之间的隔离度(典型性能与电感值的对应关系请参考典型工作特性)。
17	LO_ADJ_D	LO分集放大器的偏置控制。在该引脚与地之间连接一个电阻设置分集LO放大器的偏置电流(典型性能与电阻值的对应关系请参考典型工作特性)。
18, 28	N.C.	没有连接，无内部连接。
19	LO1	本振1输入，该输入端在内部匹配为50Ω，需要一个输入隔直电容。
23	LOSEL	本振选择，该引脚为高电平时选择LO1，为低电平时选择LO2。
27	LO2	本振2输入，该输入端在内部匹配为50Ω，需要一个输入隔直电容。
29	LO_ADJ_M	LO主放大器的偏置控制。在该引脚与地之间连接一个电阻来设置LO主放大器的偏置电流(典型性能与电阻值的对应关系请参考典型工作特性)。
31	IND_EXTM	外部主电感连接端。该引脚接地，也可以在该引脚与地之间连接一个低ESR的10nH电感，以提高RF与IF之间和LO与IF之间的隔离度(典型性能与电感值的对应关系请参考典型工作特性)。
32, 33	IFM-, IFM+	主混频器差分IF输出。各引脚均需通过上拉电感连接至VCC (参见典型应用电路)。
35	IFM_SET	IF主放大器的偏置控制。在该引脚与地之间连接一个电阻设置IF主放大器的偏置电流(典型性能与电阻值的对应关系请参考典型工作特性)。
—	EP	裸焊盘，内部连接至GND，使用多个接地过孔将该焊盘焊接到一个PCB盘，为器件与PCB地层之间提供好的散热通道。多个接地过孔还有助于改善RF性能。

双通道、SiGe、高线性度、1700MHz至2200MHz 下变频混频器，带有LO缓冲器/开关

详细说明

MAX19995A是一款双通道下变频器，设计用于提供8.7dB的转换增益、+24.8dBm的输入IP3、+13.5dBm的1dB输入压缩点以及9.2dB的噪声系数。

除具有高线性度性能外，MAX19995A还具有非常高的器件集成度。该器件集成有两个双平衡混频器用于双通道下变频。主通道和分集通道都包含非平衡变压器和匹配电路，允许50Ω单端连接至RF端口和两个LO端口。集成的单刀双掷(SPDT)开关在两个LO输入之间的切换时间为50ns，具有48dB的LO至LO隔离度，在RF端具有-35dBm的LO泄漏。此外，集成LO缓冲器可以为各混频器核提供较强的驱动能力，将MAX19995A输入端的LO驱动减小到-3dBm至+3dBm。两个通道的IF端口配合差分输出进行下变频转换，可有效改善2LO-2RF性能。

该器件可在较宽的频率范围内保证性能，适用于UMTS/WCDMA、LTE/WiMAX、DCS1800/PCS1900 GSM/EDGE、TD-SCDMA和cdma2000基站。MAX19995A能够工作在1700MHz至2200MHz RF输入范围、1750MHz至2700MHz LO范围以及50MHz至500MHz IF范围。外部IF器件可设置更低的频率范围(详细信息请参考典型工作特性)。器件也可以工作在上述范围以外，详细信息请参考典型工作特性。尽管该器件针对高端LO注入架构进行优化，但其同样可用于低端LO注入模式。然而，随着 f_{LO} 频率的降低，性能有所下降。如需改善低端LO注入的性能，请参考MAX19995数据资料。

RF端口和非平衡变压器

主通道和分集通道的RF输入端均在内部匹配为50Ω，无需外部匹配元件。输入端通过片上非平衡变压器内部直流短接到地，因此需要隔直电容。在整个1700MHz至2200MHz的RF频率范围内，RF端口的输入回波损耗典型值优于16.5dB。

LO输入、缓冲器和非平衡变压器

MAX19995A针对1750MHz至2700MHz的LO频率范围进行了优化。作为一个附加功能，MAX19995A包括一个内部LO SPDT开关，可以用于跳频设计。该开关选择两个单端LO端口中的一个，允许外部振荡器在接入之前稳定在一个特定频率上。典型LO切换时间为50ns，远远超过典型GSM应用的要求。如果不使用跳频功能，可以简单地将开关置于任意一个LO输入端。该开关由数字输入(LOSEL)控制：逻辑高电平时选择LO1；逻辑低电平时选择LO2。LO1和LO2输入端在内部匹配为50Ω，只需一个39pF的隔直电容。

LOSEL直接连接到逻辑源，为了避免损坏器件， V_{CC} 必须在LOSEL加载数字逻辑电平之前上电。对于在 V_{CC} 之前加载LOSEL信号的应用，可在LOSEL端串联一个1kΩ的电阻来限制输入电流。

主通道和分集通道采用两级LO缓冲器，允许使用宽输入功率范围的LO驱动。片上低损耗非平衡变压器和LO缓冲器配合使用，驱动双平衡混频器。LO输入端与IF输出端之间的所有接口和匹配元件均已集成在芯片上。

高线性度混频器

MAX19995A双通道下变频器的核心由两个双平衡、高性能无源混频器组成。片上LO缓冲器具有较大的LO摆幅，可提供优异的线性度指标。与集成IF放大器配合使用时，级联后的IIP3、2LO-2RF抑制和噪声系数的典型值分别为+24.8dBm、64dBc和9.2dB。

差分IF

MAX19995A具有50MHz至500MHz的IF频率范围，其低端频率取决于外部IF元件的频率响应。注意：这些差分端口可以改善IIP2性能。单端IF应用需要一个4:1(阻抗比)的非平衡变压器将200Ω的差分IF阻抗转换为50Ω单端输出。经过非平衡变压器之后，回波损耗的典型值为11.5dB。用户可以在混频器的IF端口使用差分IF放大器，但是IFD+/IFD-和IFM+/IFM-端口均需要隔直，以防止外部直流进入混频器的IF端口。

双通道、SiGe、高线性度、1700MHz至2200MHz 下变频混频器，带有LO缓冲器/开关

应用信息

布局考虑

输入和输出匹配

RF和LO输入端在内部匹配为 50Ω ，无需匹配元件。在整个1700MHz至2200MHz的RF频率范围内，RF端口的输入回波损耗优于16.5dB；而在整个LO范围内，LO端口的回波损耗优于15dB。RF和LO输入端只需通过隔直电容连接。IF输出阻抗为 200Ω （差分）。为方便评估，通过外部低损耗4:1（阻抗比）非平衡变压器将该阻抗转化成 50Ω 单端输出（参见典型应用电路）。

合理的PCB设计是任何RF/微波电路的一个重要部分。RF信号线应尽可能短，以减小损耗、辐射和电感。连接至混频器的负载阻抗必须保证IF-和IF+与地之间的电容不会超过几个皮法(pF)。为获得最佳性能，接地引脚须直接与封装底部的裸焊盘连接。PCB上的裸焊盘必须连接至PCB的地层。建议采用多个过孔将该焊盘连接至地层。这种方法能为器件提供一个良好的RF/散热路径。将器件封装底部的裸焊盘焊接至PCB。电路板布局请参考MAX19995A评估板，Gerber文件可从www.maxim-ic.com.cn申请。

降低功耗模式

电源旁路

MAX19995A的每个通道均具有两个引脚(LO_ADJ_、IF_ SET)，允许通过外部电阻设置内部偏置电流。电阻的标称值如表1所示。增大电阻值可降低功耗，但代价是性能有所下降。如果没有 $\pm 1\%$ 精度的电阻，可以采用 $\pm 5\%$ 的电阻替代。

合理的电源旁路对高频电路的稳定性至关重要。如典型应用电路所示，对各 V_{CC} 引脚和TAPMAIN/TAPDIV引脚使用电容旁路(元件值如表1所示)。将TAPMAIN/TAPDIV的对地旁路电容放置在距相应引脚100mil以内的位置。

选择3.3V为混频器供电也可以显著降低功耗，这种方式可以将整体功耗降低54%，具体细节请参考3.3V Supply AC Electrical Characteristics和典型工作特性中与3.3V供电相关的特性曲线。

裸焊盘的RF/散热考虑

IND_EXT_电感

在需要改善RF与IF之间和LO与IF之间隔离度的应用中，可以在IND_EXT_（引脚15和31）与地之间连接一个低ESR电感。如果不需要很高的隔离度，可以用一个 0Ω 电阻将IND_EXT_连接至地。隔离度与电感值之间的折中选择请参考典型工作特性。

MAX19995A采用36引脚、薄型QFN-EP封装，其裸焊盘(EP)提供了一个与管芯之间的低热阻通路。在安装MAX19995A的PCB与EP之间保持良好的热传递通道非常重要。此外，EP应通过一个低电感路径接地。EP必须直接或通过一系列电镀过孔焊接至PCB的地层。

双通道、SiGe、高线性度、1700MHz至2200MHz 下变频混频器，带有LO缓冲器/开关

MAX19995A

表 1. 元件值

DESIGNATION	QTY	DESCRIPTION	COMPONENT SUPPLIER
C1, C2, C7, C8, C14, C16	6	39pF microwave capacitors (0402)	Murata Electronics North America, Inc.
C3, C6	2	0.033μF microwave capacitors (0603)	Murata Electronics North America, Inc.
C4, C5	2	Not used	—
C9, C13, C15, C17, C18	5	0.01μF microwave capacitors (0402)	Murata Electronics North America, Inc.
C10, C11, C12, C19, C20, C21	6	150pF microwave capacitors (0603)	Murata Electronics North America, Inc.
L1, L2, L4, L5	4	120nH wire-wound high-Q inductors (0805)	Coilcraft, Inc.
L3, L6	2	10nH wire-wound high-Q inductors (0603). Smaller values can be used at the expense of some performance loss (see the <i>Typical Operating Characteristics</i>).	Coilcraft, Inc.
R1, R4	2	681Ω ±1% resistors (0402). Used for V_{CC} = 5.0V applications. Larger values can be used to reduce power at the expense of some performance loss (see the <i>Typical Operating Characteristics</i>).	Digi-Key Corp.
		909Ω ±1% resistors (0402). Used for V_{CC} = 3.3V applications.	
R2, R5	2	1.5kΩ ±1% resistors (0402). Used for V_{CC} = 5.0V applications. Larger values can be used to reduce power at the expense of some performance loss (see the <i>Typical Operating Characteristics</i>).	Digi-Key Corp.
		1kΩ ±1% resistors (0402). Used for V_{CC} = 3.3V applications.	
R3, R6	2	0Ω resistors (1206)	Digi-Key Corp.
T1, T2	2	4:1 transformers (200:50) TC4-1W-17	Mini-Circuits
U1	1	MAX19995A IC (36 TQFN-EP)	Maxim Integrated Products, Inc.

双通道、SiGe、高线性度、1700MHz至2200MHz 下变频混频器，带有LO缓冲器/开关

典型应用电路

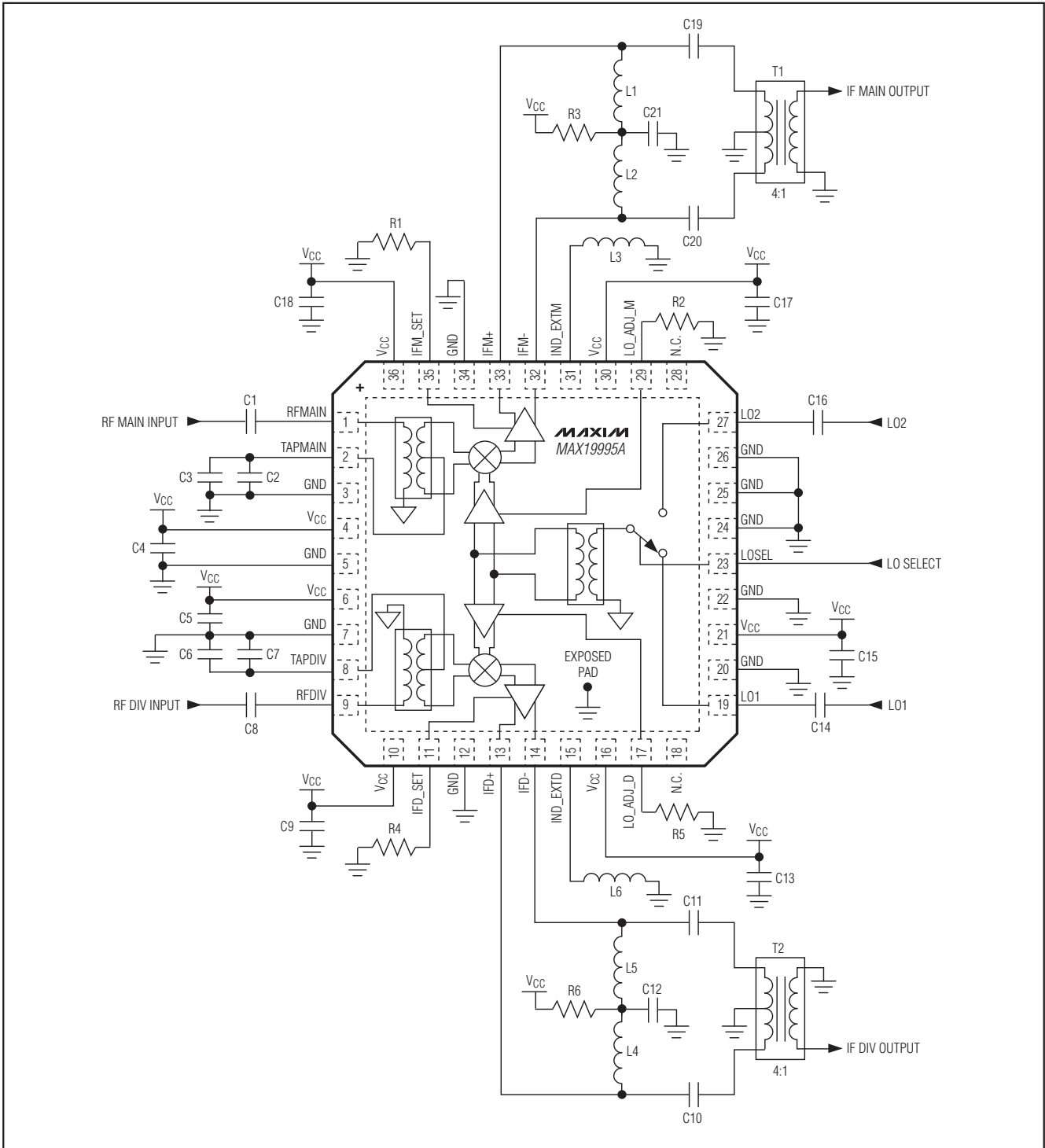

双通道、SiGe、高线性度、1700MHz至2200MHz 下变频混频器，带有LO缓冲器/开关

引脚配置/功能框图

MAX19995A

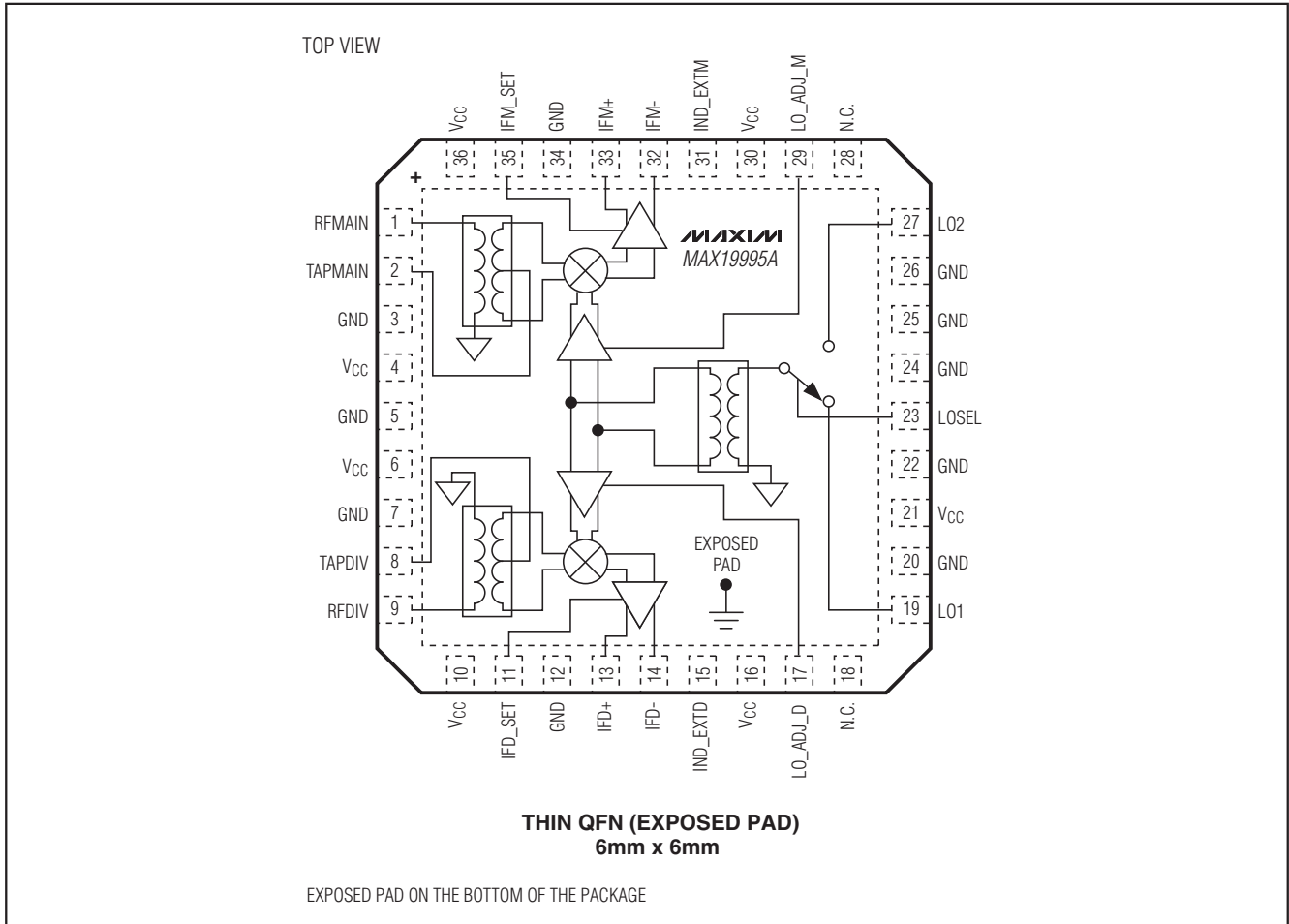

芯片信息

PROCESS: SiGe BiCMOS

Maxim北京办事处

北京 8328信箱 邮政编码 100083

免费电话: 800 810 0310

电话: 010-6211 5199

传真: 010-6211 5299

Maxim不对Maxim产品以外的任何电路使用负责，也不提供其专利许可。Maxim保留在任何时间、没有任何通报的前提下修改产品资料和规格的权利。

Maxim Integrated Products, 120 San Gabriel Drive, Sunnyvale, CA 94086 408-737-7600

23

© 2009 Maxim Integrated Products

Maxim是Maxim Integrated Products, Inc.的注册商标。

封装信息

如需最近的封装外形信息和焊盘布局，请查询
www.maxim-ic.com.cn/packages.

封装类型	封装编码	文档编号
36引脚薄型QFN-EP	T3666+2	21-0141